

BOX RLFx (F400+ATEX)



BACKWARD CENTRIFUGAL IMPELLER IN SOUNDPROOF CABINET 400^o/2H

MANUFACTURING FEATURES

- Box manufactured in galvanised steel sheet.
- Circular inlet flange.
- Backward impeller with self-cleaning system, direct coupling motor.
- Standard asynchronous squirrel-cage motor with IP-55 protection and Class H insulation type 400^oC/2h and ATEX (II3G).
- Manufactured with standard voltages: 230/400V 50Hz in three phase motors up to 3kW and 400 50Hz for higher powers and 2 speed motors.
- Exchangeable pannels.
- Open outlet
- ATEX II3G.

APPLICATIONS

Designed for inline installation, they are suitable for:

- Air renewal in buildings and industries.
- Maximum working temperature: 60^oC.
- Smoke extraction in case of fire, with motor located into the hazardous area (400^o/2h)

Official homologation by the European laboratory APPLUS according to EN 12101-3:2015
 Certification Nr: 0370-CPR-0582

Accessories



INT

INT
400

SFC

TIAC

Technical data

Three-phase motor / 4 poles

Code	Model	R.P.M.	Rated I. (A) 400V	Rated power kW	Max. Airflow w m3/h	Sound db (A)**	Weight t	Connect. diagram
241390196	BOX RLFX 400 T4 0,75kW	1415	1,95	0,75	4.890	50	115	1
241460196	BOX RLFX 450 T4 1,1kW	1430	2,7	1,1	6.960	54	142	1
241520196	BOX RLFX 500 T4 1,5kW	1435	3,6	1,5	9.540	58	147	1
241600196	BOX RLFX 560 T4 2,2kW	1455	4,55	2,2	13.400	61	187	1
241670196	BOX RLFX 630 T4 4kW	1455	8,57	4	19.080	64	198	1
241770196	BOX RLFX 710 T4 7,5kW	1455	14,46	7,5	27.310	68	263	1
241830196	BOX RLFX 800 T4 11kW	1455	21,2	11	39.060	71	339	1

Three-phase motor / 6 poles

Code	Model	R.P.M.	Rated I. (A) 400V	Rated power kW	Max. Airflow w m3/h	Sound db (A)**	Weight t	Connect. diagram
241440196	BOX RLFX 400 T6 0,55kW	920	1,49	0,55	3.170	41	115	1
241470196	BOX RLFX 450 T6 0,55kW	920	1,49	0,55	4.510	45	141	1
241540196	BOX RLFX 500 T6 0,55kW	920	1,49	0,55	6.300	48	146	1
241620196	BOX RLFX 560 T6 0,75kW	920	1,95	0,75	8.680	51	176	1
241660196	BOX RLFX 630 T6 1,5kW	960	3,71	1,5	12.360	55	218	1
241760196	BOX RLFX 710 T6 2,2kW	960	5,3	2,2	17.700	58	273	1
241840196	BOX RLFX 800 T6 4kW	945	9,46	4	25.310	62	339	1

2 SPEED MOTOR / 4/8 poles

Code	Model	R.P.M.	Rated I. (A) 400V	Rated power kW	Max. Airflow w m3/h	Sound db (A)**	Weight t	Connect. diagram
2415201962V	BOX RLFX 500 T4/T8 1,5/0,3kW	1425	3,26/0,88	1,5/ 0,3	9.540	58	147	2
2416001962V	BOX RLFX 560 T4/T8 2,2/0,45kW	1434	4,84/2	2,2/ 0,45	13.400	61	187	2
2416701962V	BOX RLFX 630 T4/T8 4/0,75kW	1440	8,6/2,6	4/0,75	19.080	64	198	2
2417701962V	BOX RLFX 710 T4/T8 7,5/1,5kW	1461	14,9/3,7	7,5/ 1,5	27.310	68	273	2

Notes:

** Total sound pressure level at the point of maximum flow measured in dB(A) in the suction measured in free field at a distance of 6m from the source

Dimensions

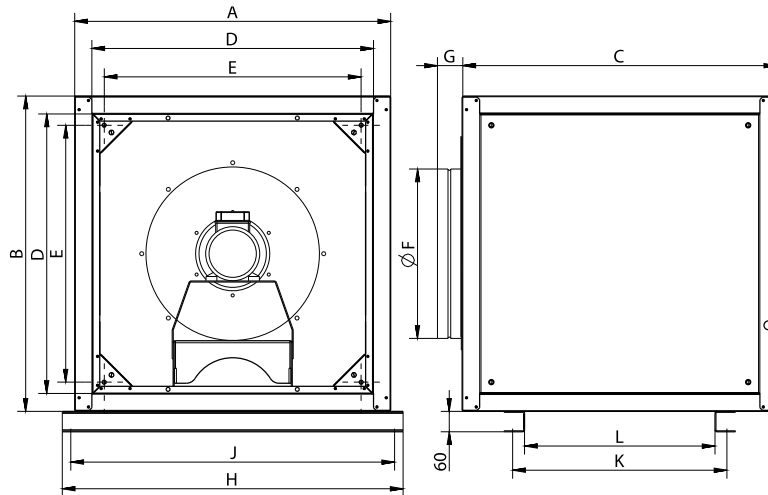

Model	A	B	C	D	E	G	H	J	K
BOX RLFX 400 T4 0,75kW	800	800	800	696	628,5	74	1002	952	628,5
BOX RLFX 400 T6 0,55kW	800	800	800	696	628,5	74	1002	952	628,5
BOX RLFX 450 T4 1,1kW	800	800	800	696	628,5	74	1002	952	628,5
BOX RLFX 450 T6 0,55kW	800	800	800	696	628,5	74	1002	952	628,5
BOX RLFX 500 T4 1,5kW	925	925	925	821	753	74	1127	1077	753
BOX RLFX 500 T6 0,55kW	925	925	925	821	753	74	1127	1077	753
BOX RLFX 500 T4/T8 1,5/0,3kW	925	925	925	821	753	74	1127	1077	753
BOX RLFX 560 T4 2,2kW	925	925	925	821	753	74	1127	1077	753
BOX RLFX 560 T6 0,75kW	925	925	925	821	753	74	1127	1077	753
BOX RLFX 560 T4/T8 2,2/0,45kW	925	925	925	821	753	74	1127	1077	753
BOX RLFX 630 T4 4kW	1000	1000	1000	892	828	74	1203	1153	828
BOX RLFX 630 T6 1,5kW	1000	1000	1000	892	828	74	1203	1153	828
BOX RLFX 630 T4/T8 4/0,75kW	1000	1000	1000	892	828	74	1203	1153	828
BOX RLFX 710 T4 7,5kW	1000	1000	1000	892	828	74	1203	1153	828
BOX RLFX 710 T6 2,2kW	1000	1000	1000	892	828	74	1203	1153	828
BOX RLFX 710 T4/T8 7,5/1,5kW	1000	1000	1000	892	828	74	1203	1153	828
BOX RLFX 800 T4 11kW	1060	1060	1060	952	887	74	1262	1212	887
BOX RLFX 800 T6 4kW	1060	1060	1060	952	887	74	1262	1212	887

Model	L	ØF
BOX RLFX 400 T4 0,75kW	558,5	398
BOX RLFX 400 T6 0,55kW	558,5	398
BOX RLFX 450 T4 1,1kW	558,5	448
BOX RLFX 450 T6 0,55kW	558,5	448
BOX RLFX 500 T4 1,5kW	683	498

Model	L	ØF
BOX RLFX 500 T6 0,55kW	683	498
BOX RLFX 500 T4/T8 1,5/0,3kW	683	498
BOX RLFX 560 T4 2,2kW	683	548
BOX RLFX 560 T6 0,75kW	683	548
BOX RLFX 560 T4/T8 2,2/0,45kW	683	548
BOX RLFX 630 T4 4kW	758	628
BOX RLFX 630 T6 1,5kW	758	628
BOX RLFX 630 T4/T8 4/0,75kW	758	628
BOX RLFX 710 T4 7,5kW	758	698
BOX RLFX 710 T6 2,2kW	758	698
BOX RLFX 710 T4/T8 7,5/1,5kW	758	698
BOX RLFX 800 T4 11kW	817	798
BOX RLFX 800 T6 4kW	817	798

Wiring diagram

DIAGRAM N° 1

230/400V

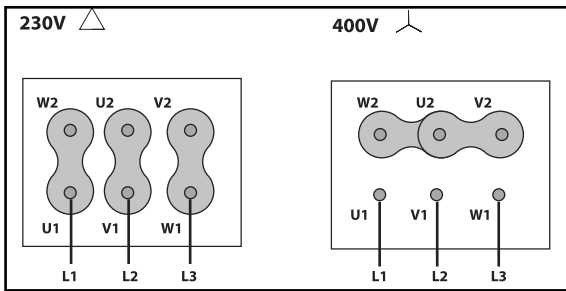

400/690V

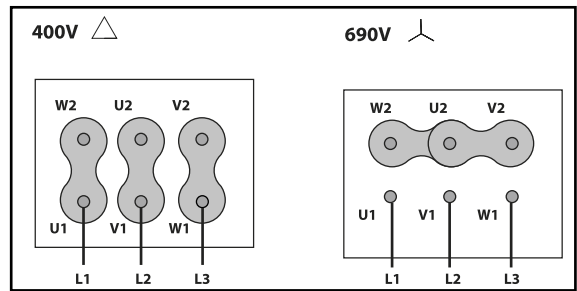
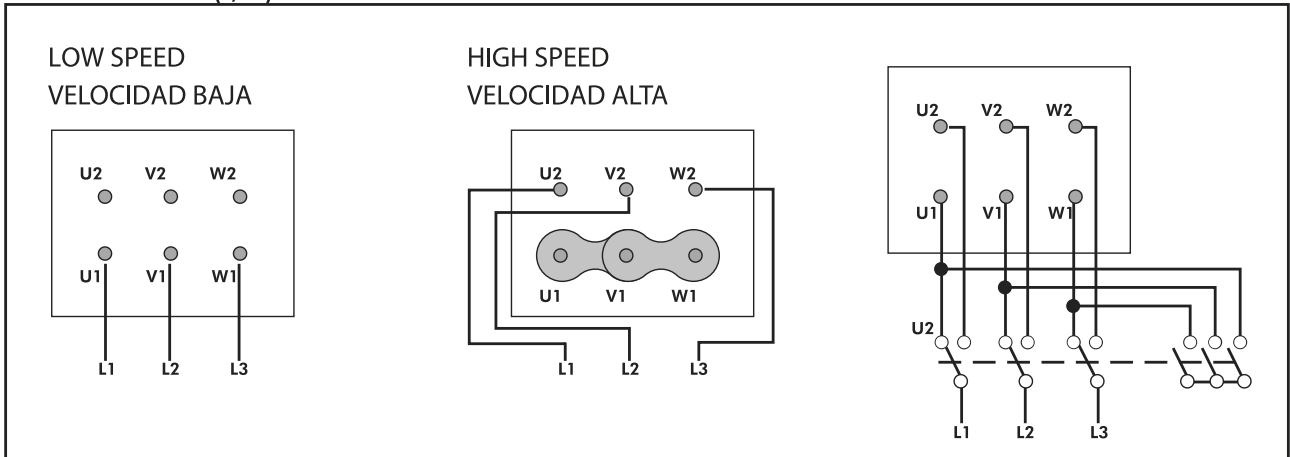

DIAGRAM N° 2

400V DAHLANDER (Y,YY)



CHARACTERISTIC CURVE

1	BOX RLFX 400 T4 0,75kW	2	BOX RLFX 450 T4 1,1kW	3	BOX RLFX 500 T4 1,5kW	4	BOX RLFX 560 T4 2,2kW
5	BOX RLFX 630 T4 4kW	6	BOX RLFX 710 T4 7,5kW	7	BOX RLFX 800 T4 11kW		

AIR FLOW - PRESSURE

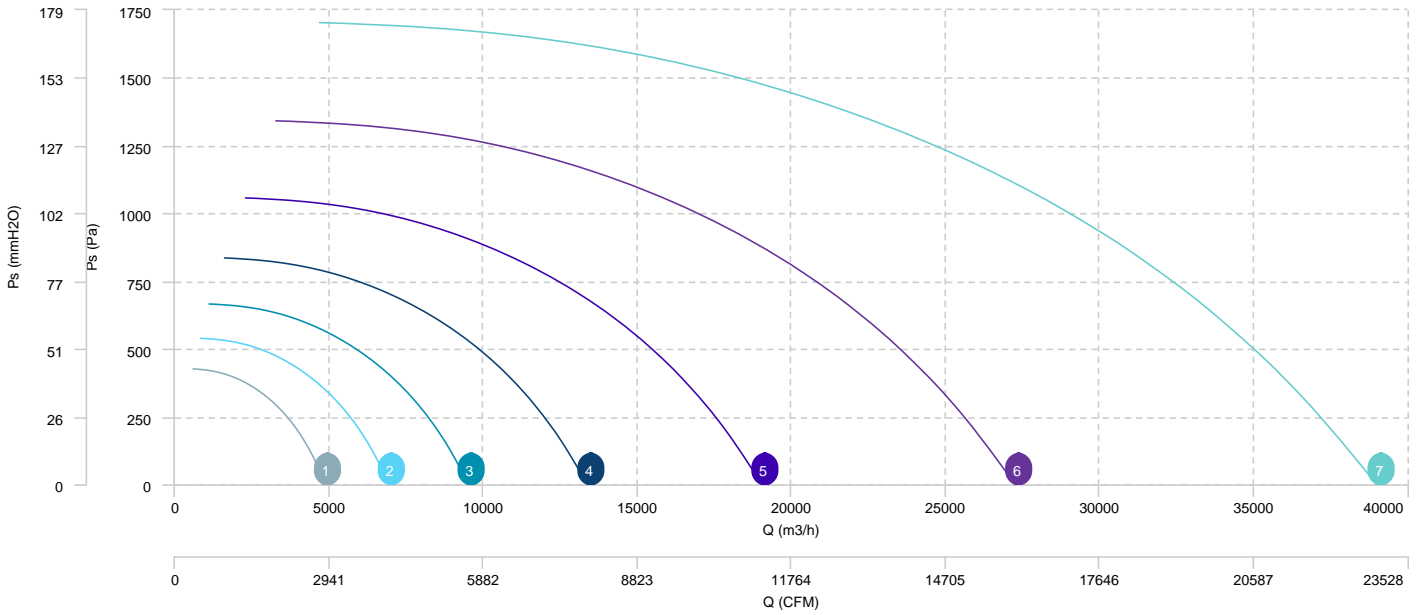

AIR FLOW - ABSORBED POWER

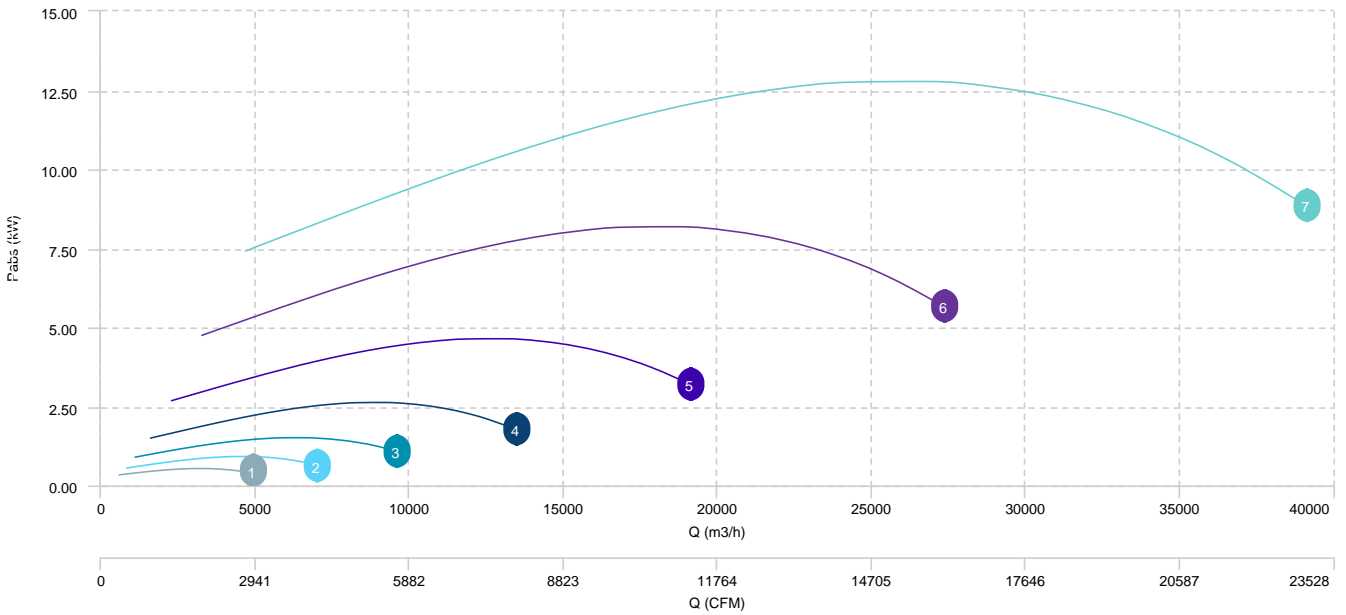

- | | | | | | | | |
|---|------------------------|---|------------------------|---|------------------------|---|------------------------|
| 1 | BOX RLFX 400 T6 0,55kW | 2 | BOX RLFX 450 T6 0,55kW | 3 | BOX RLFX 500 T6 0,55kW | 4 | BOX RLFX 560 T6 0,75kW |
| 5 | BOX RLFX 630 T6 1,5kW | 6 | BOX RLFX 710 T6 2,2kW | 7 | BOX RLFX 800 T6 4kW | | |

AIR FLOW - PRESSURE

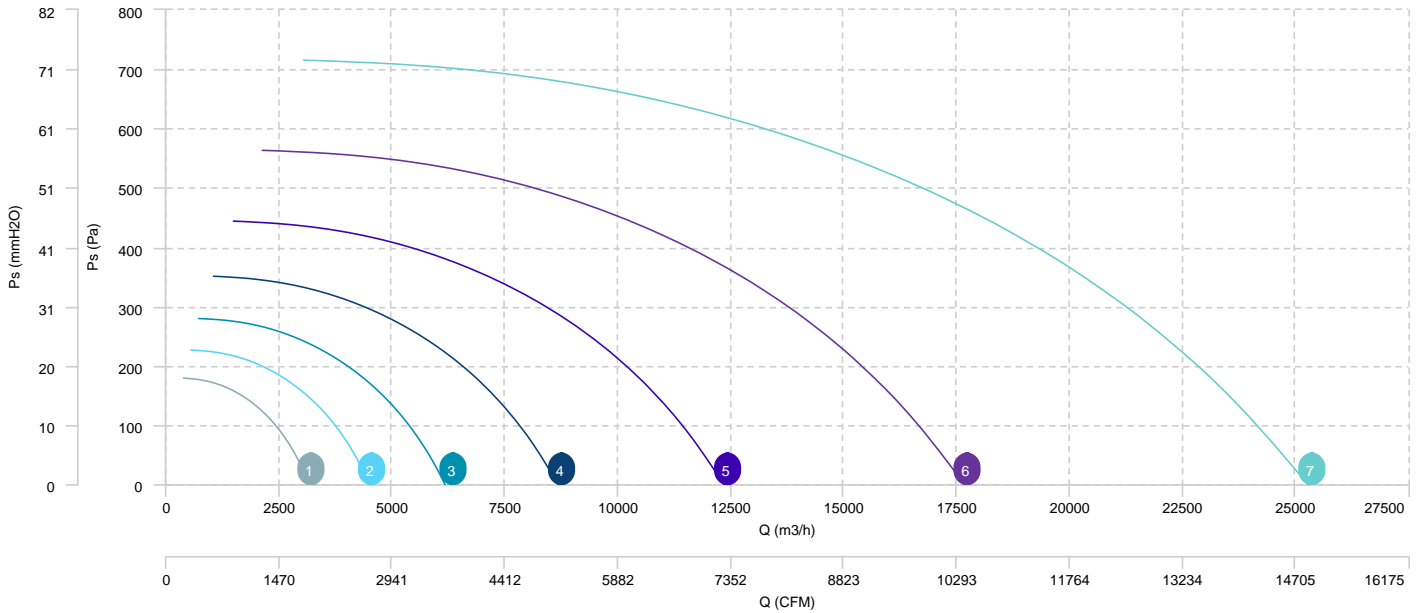

AIR FLOW - ABSORBED POWER

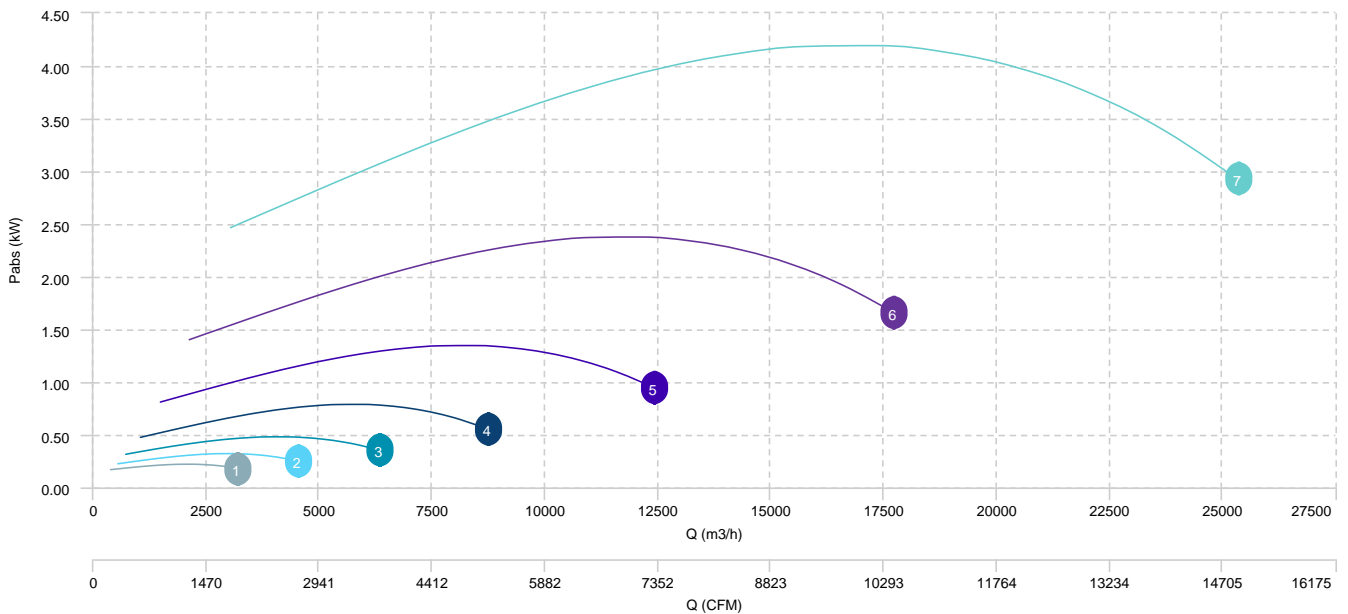

- 1 BOX RLFX 500 T4/T8 1, 5/0,3kW
- 2 BOX RLFX 560 T4/T8 2, 2/0,45kW
- 3 BOX RLFX 630 T4/T8 4/0, 75kW
- 4 BOX RLFX 710 T4/T8 7, 5/1,5kW

AIR FLOW - PRESSURE (4 poles)

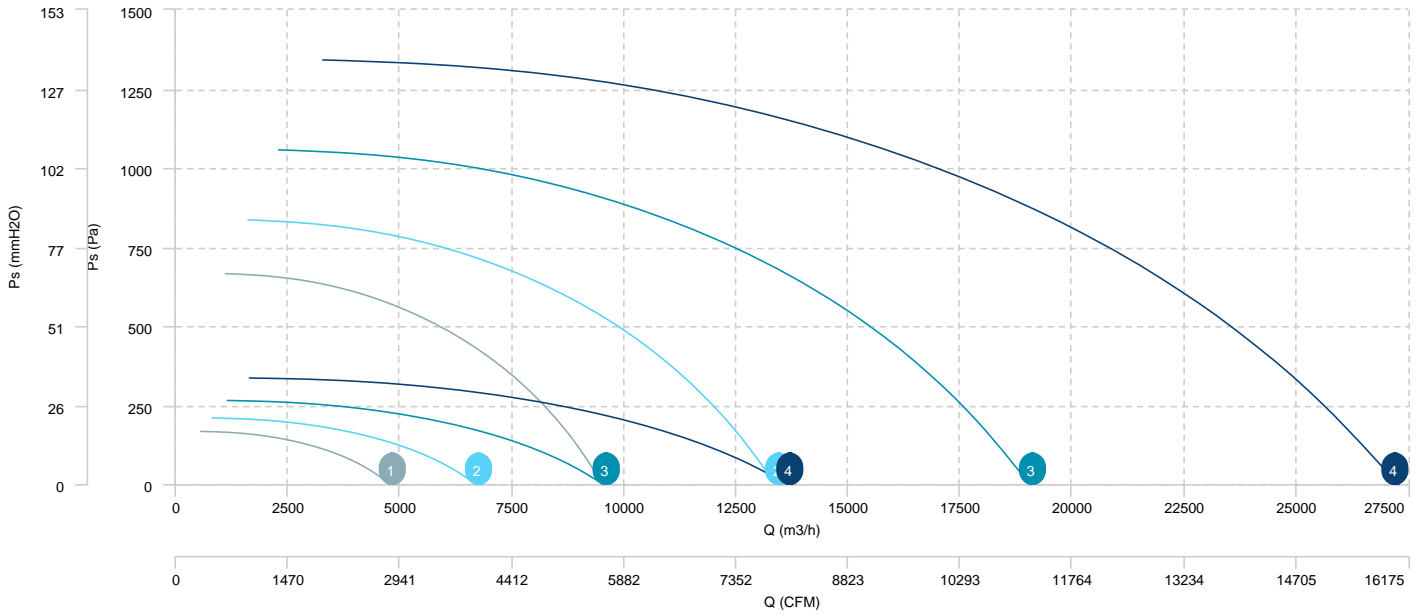

1 BOX RLFX 500 T4/T8 1,
5/0,3kW

2 BOX RLFX 560 T4/T8 2,
2/0,45kW

3 BOX RLFX 630 T4/T8 4/0,
75kW

4 BOX RLFX 710 T4/T8 7,
5/1,5kW

AIR FLOW - PRESSURE (8 poles)

Sound data

Sound / 4 poles

Sound power Lw dB (A)										
Model		63 Hz	125 Hz	250 Hz	500 Hz	1000 Hz	2000 Hz	4000 Hz	8000 Hz	Total
BOX RLFX 400 T4 0,75kW	Inlet	54	62	67	70	71	69	66	63	76
BOX RLFX 450 T4 1,1kW	Inlet	58	66	70	73	75	73	70	67	80
BOX RLFX 500 T4 1,5kW	Inlet	61	69	74	77	78	77	73	71	84
BOX RLFX 560 T4 2,2kW	Inlet	64	72	77	80	81	79	76	73	87
BOX RLFX 630 T4 4kW	Inlet	68	76	80	84	85	83	80	77	90
BOX RLFX 710 T4 7,5kW	Inlet	71	79	84	87	88	87	83	81	94
BOX RLFX 800 T4 11kW	Inlet	75	83	88	91	92	90	87	84	97

Sound / 6 poles

Sound power Lw dB (A)										
Model		63 Hz	125 Hz	250 Hz	500 Hz	1000 Hz	2000 Hz	4000 Hz	8000 Hz	Total
BOX RLFX 400 T6 0,55kW	Inlet	45	53	57	60	62	60	57	54	67
BOX RLFX 450 T6 0,55kW	Inlet	48	56	61	64	65	63	60	57	71
BOX RLFX 500 T6 0,55kW	Inlet	52	60	65	68	69	67	64	61	74
BOX RLFX 560 T6 0,75kW	Inlet	55	63	67	71	72	70	67	64	77
BOX RLFX 630 T6 1,5kW	Inlet	58	66	71	74	75	74	70	68	81
BOX RLFX 710 T6 2,2kW	Inlet	62	70	75	78	79	77	74	71	84
BOX RLFX 800 T6 4kW	Inlet	66	74	78	81	83	81	78	75	88

Sound / 4/8 poles

Sound power Lw dB (A)										
Model		63 Hz	125 Hz	250 Hz	500 Hz	1000 Hz	2000 Hz	4000 Hz	8000 Hz	Total
BOX RLFX 500 T4/T8 1,5/0,3kW (1420 RPM)	Inlet	45	53	57	61	62	60	57	54	67
BOX RLFX 560 T4/T8 2,2/0,45kW (1420 RPM)	Inlet	48	56	60	64	65	63	60	57	70
BOX RLFX 630 T4/T8 4/0,75kW (1420 RPM)	Inlet	51	59	64	67	68	66	63	60	74
BOX RLFX 710 T4/T8 7,5/1,5kW (1420 RPM)	Inlet	55	63	67	71	72	70	67	64	77

Notes:

* To calculate the sound power level at different rpm from those indicated above, use the following formula:

$$Lw \text{ dB(A)}_{\text{rpmA}} = Lw \text{ dB(A)}_{\text{rpmB}} + 52.5 \cdot \log_{10} \frac{\text{rpmA}}{\text{rpmB}}$$