

HB



WALL FAN , VARIABLE PITCH BLADES

MANUFACTURING FEATURES:

- Plate axial fan with circular reinforced frame.
- Motor-impeller modular assembly for complete versatility.
- Corrosion-resistant powder coat polyester resin.
- Standard asynchronous squirrel-cage motor with IP-55 protection and Class F insulation. Manufactured with standard voltages: 230V 50Hz in single phase motors and 230/400V 50Hz in three phase, motors up to 4kW and 400/690V 50Hz for higher powers.
- HB :Polypropylene impeller (A2 profile) or polyamide impeller reinforced with fibreglass (other profiles) with variable pitch angle.
- HBA : Cast aluminum impeller with variable pitch angle.

APPLICATIONS:

Designed for wall or duct installation, they are suitable for:

- Air renewal in buildings and industries.
- Maximum working temperature: 1ph 50°C, 3ph 60°C.

UNDER REQUEST:

- Supply impeller (air direction from impeller to motor)
- 100% reversible impeller.
- 60Hz fans and special voltages.
- Hot-dipped galvanized or stainless steel housing.

Accessories



AC



BA-400



BAD



INT



JE 45



MC HB



PC2



PCP



RP0



RP1



SFC

Technical data

Single-phase motor / 2 poles

Code	Model	Angle	Min. Rated power kW	Max. Rated power kW	Max. Airflow m ³ /h	Sound db (A)**	Weight t	Connect. diagram
-	HB 35 M2 (A0:6)	25° - 40°	0,55	1,10	6.810	60	9,10	1

Single-phase motor / 4 poles

Code	Model	Angle	Min. Rated power kW	Max. Rated power kW	Max. Airflow m ³ /h	Sound db (A)**	Weight t	Connect. diagram
-	HB 35 M4 (A0:6)	35° - 40°	0,12	0,12	3.440	46	9,10	1
-	HB 40 M4 (A0:6)	35° - 40°	0,18	0,25	4.670	51	10,60	1
-	HB 45 M4 (A0:6)	35° - 40°	0,25	0,25	6.360	52	12,80	1
-	HB 45 M4 (A5:6)	25° - 45°	0,25	0,55	6.760	51	14,20	1
-	HB 50 M4 (A0:6)	35° - 40°	0,37	0,37	8.140	53	16,90	1
-	HB 50 M4 (A5:6)	25° - 45°	0,25	0,75	9.420	54	18,40	1
-	HB 56 M4 (A2:6)	20° - 45°	0,37	0,75	13.910	60	21,80	1
-	HB 56 M4 (A2:9)	20° - 45°	0,37	0,75	14.710	60	22,90	1
-	HB 56 M4 (A5:6)	20° - 45°	0,37	0,75	14.640	70	21	1
-	HB 63 M4 (A2:6)	20° - 30°	0,37	0,75	13.810	60	25,90	1
-	HB 63 M4 (A2:9)	20° - 27,5°	0,37	0,75	12.510	62	27	1
-	HB 63 M4 (A5:6)	20° - 25°	0,37	0,75	12.020	63	24,90	1
-	HB 71 M4 (A2:6)	20° - 25°	0,75	0,75	15.510	64	29,90	1
-	HB 71 M4 (A2:9)	20° - 20°	0,75	0,75	12.080	68	31,20	1
-	HB 71 M4 (A5:6)	20° - 20°	0,75	0,75	13.640	66	28,90	1

Single-phase motor / 6 poles

Code	Model	Angle	Min. Rated power kW	Max. Rated power kW	Max. Airflow m ³ /h	Sound db (A)**	Weight t	Connect. diagram
-	HB 56 M6 (A2:6)	20° - 45°	0,12	0,25	9.000	51	21,80	1
-	HB 56 M6 (A2:9)	20° - 45°	0,12	0,25	9.520	51	22,90	1
-	HB 56 M6 (A5:6)	20° - 45°	0,18	0,25	9.760	67	21	1
-	HB 63 M6 (A2:6)	20° - 45°	0,37	0,37	13.010	53	25,90	1
-	HB 63 M6 (A2:9)	20° - 45°	0,37	0,37	14.110	53	27	1
-	HB 63 M6 (A5:6)	20° - 45°	0,37	0,37	13.570	71	24,90	1

Code	Model	Angle	Min. Rated power kW	Max. Rated power kW	Max. Airflow m ³ /h	Sound db (A)**	Weight t	Connect. diagram
-	HB 71 M6 (A2:6)	20° - 45°	0,37	0,37	18.110	56	29,90	1
-	HB 71 M6 (A2:9)	20° - 45°	0,37	0,37	19.610	58	31,20	1
-	HB 71 M6 (A5:6)	20° - 45°	0,37	0,37	18.350	76	28,90	1

Three-phase motor / 4 poles

Code	Model	Angle	Min. Rated power kW	Max. Rated power kW	Max. Airflow m ³ /h	Sound db (A)**	Weight t*	Connect. diagram
-	HB 35 T4 (A0:6)	35° - 40°	0,12	0,12	3.440	46	9,10	2
-	HB 40 T4 (A0:6)	35° - 40°	0,18	0,18	4.670	51	10,60	2
-	HB 45 T4 (A0:6)	35° - 40°	0,25	0,25	6.360	52	12,80	2
-	HB 45 T4 (A5:6)	25° - 45°	0,25	0,55	6.760	51	14,20	2
-	HB 50 T4 (A0:6)	35° - 40°	0,37	0,37	8.140	53	16,90	2
-	HB 50 T4 (A5:6)	25° - 45°	0,25	0,75	9.420	54	18,40	2
-	HB 56 T4 (A2:6)	20° - 45°	0,37	2,20	13.910	60	21,80	2
-	HB 56 T4 (A2:9)	20° - 45°	0,37	2,20	14.710	60	22,90	2
-	HB 56 T4 (A5:6)	20° - 45°	0,37	2,20	14.640	70	21	2
-	HB 63 T4 (A2:6)	20° - 45°	0,37	3	20.110	62	25,90	2
-	HB 63 T4 (A2:9)	20° - 45°	0,37	3	21.810	63	27	2
-	HB 63 T4 (A5:6)	20° - 45°	0,37	3	20.350	74	24,90	2
-	HB 71 T4 (A2:6)	20° - 45°	0,75	4	27.910	65	29,90	2
-	HB 71 T4 (A2:9)	20° - 45°	0,75	4	30.310	68	31,20	2
-	HB 71 T4 (A5:6)	20° - 45°	0,75	4	27.520	79	28,90	2
-	HB 80 T4 (A2:6)	20° - 45°	1,10	9,20	39.010	67	35,40	2
-	HB 80 T4 (A2:9)	20° - 45°	1,10	9,20	41.810	72	36,80	2
-	HB 80 T4 (A5:6)	20° - 40°	1,10	4	34.470	71	34,30	2
-	HB 90 T4 (A6:3)	20° - 42°	3	15	50.950	75	52,10	2
-	HB 90 T4 (A6:6)	20° - 42°	3	15	58.310	76	54,40	2
-	HB 100 T4 (A6:3)	20° - 42°	5,50	22	69.340	76	64,20	2
-	HB 100 T4 (A6:6)	20° - 42°	5,50	22	81.210	80	66,70	2
-	HB 112 T4 (A6:3)	20° - 42°	5,50	37	92.050	78	72,70	2
-	HB 112 T4 (A6:6)	20° - 42°	5,50	37	109.010	83	75,60	2
-	HB 125 T4 (A7:4)	20° - 42°	7,50	45	132.010	85	86	2
-	HB 125 T4 (A7:8)	20° - 42°	11	45	151.010	89	90	2

Three-phase motor / 6 poles

Code	Model	Angle	Min. Rated power kW	Max. Rated power kW	Max. Airflow m ³ /h	Sound db (A)**	Weight t*	Connect. diagram
-	HB 35 T6 (A0:6)	35° - 40°	0,12	0,12	2.230	37	9,10	2
-	HB 40 T6 (A0:6)	35° - 40°	0,12	0,12	3.030	42	10,60	2
-	HB 45 T6 (A0:6)	35° - 40°	0,12	0,12	4.120	42	12,80	2
-	HB 45 T6 (A5:6)	25° - 45°	0,18	0,18	4.380	42	14,20	2
-	HB 50 T6 (A0:6)	35° - 40°	0,12	0,12	5.270	44	16,90	2
-	HB 50 T6 (A5:6)	25° - 45°	0,18	0,18	6.100	45	18,40	2
-	HB 56 T6 (A2:6)	20° - 45°	0,12	0,55	9.000	51	21,80	2
-	HB 56 T6 (A2:9)	20° - 45°	0,12	0,55	9.520	51	22,90	2
-	HB 56 T6 (A5:6)	20° - 45°	0,18	0,55	9.760	67	21	2
-	HB 63 T6 (A2:6)	20° - 45°	0,37	0,75	13.010	53	25,90	2
-	HB 63 T6 (A2:9)	20° - 45°	0,37	0,75	14.110	53	27	2
-	HB 63 T6 (A5:6)	20° - 45°	0,37	0,75	13.570	71	24,90	2
-	HB 71 T6 (A2:6)	20° - 45°	0,37	1,10	18.110	56	29,90	2
-	HB 71 T6 (A2:9)	20° - 45°	0,37	1,10	19.610	58	31,20	2
-	HB 71 T6 (A5:6)	20° - 45°	0,37	1,10	18.350	76	28,90	2
-	HB 80 T6 (A2:6)	20° - 45°	0,75	2,20	25.310	57	35,40	2
-	HB 80 T6 (A2:9)	20° - 45°	0,75	2,20	27.110	63	36,80	2
-	HB 80 T6 (A5:6)	20° - 45°	0,75	2,20	25.190	72	34,30	2
-	HB 90 T6 (A6:3)	20° - 42°	0,75	4	33.010	65	52,10	2
-	HB 90 T6 (A6:6)	20° - 42°	0,75	4	37.810	66	54,40	2
-	HB 100 T6 (A6:3)	20° - 42°	1,10	7,50	44.970	66	64,20	2
-	HB 100 T6 (A6:6)	20° - 42°	1,10	7,50	52.610	70	66,70	2
-	HB 112 T6 (A6:3)	20° - 42°	1,50	11	59.660	69	72,70	2
-	HB 112 T6 (A6:6)	20° - 42°	1,50	11	70.510	73	75,60	2
-	HB 125 T6 (A7:4)	20° - 42°	2,20	15	85.410	76	86	2
-	HB 125 T6 (A7:8)	20° - 42°	3	15	98.110	80	90	2

2 SPEED MOTOR / 4/8 poles

Code	Model	Angle	Min. Rated power kW	Max. Rated power kW	Max. Airflow m ³ /h	Sound db (A)**	Weight t*	Connect. diagram
-	HB 35 T4/T8 (A0:6)	35° - 40°	0,25	0,25	3.440	46	9,10	3
-	HB 40 T4/T8 (A0:6)	35° - 40°	0,25	0,25	4.670	51	10,60	3
-	HB 45 T4/T8 (A0:6)	35° - 40°	0,25	0,25	6.360	52	12,80	3
-	HB 45 T4/T8 (A5:6)	25° - 45°	0,25	0,55	6.760	51	14,20	3
-	HB 50 T4/T8 (A0:6)	35° - 40°	0,33	0,33	8.140	53	16,90	3

Code	Model	Angle	Min. Rated power kW	Max. Rated power kW	Max. Airflow w m3/h	Sound db (A)**	Weigh t*	Connect. diagram
-	HB 50 T4/T8 (A5:6)	25° - 45°	0,25	0,75	9.420	54	18,40	3
-	HB 56 T4/T8 (A2:6)	20° - 45°	0,33	2,20	13.910	60	21,80	3
-	HB 56 T4/T8 (A2:9)	20° - 45°	0,33	2,20	14.710	60	22,90	3
-	HB 56 T4/T8 (A5:6)	20° - 45°	0,33	2,20	14.640	70	21	3
-	HB 63 T4/T8 (A2:6)	20° - 45°	0,33	3	20.110	62	25,90	3
-	HB 63 T4/T8 (A2:9)	20° - 45°	0,33	3	21.810	63	27	3
-	HB 63 T4/T8 (A5:6)	20° - 45°	0,33	3	20.350	74	24,90	3
-	HB 71 T4/T8 (A2:6)	20° - 45°	0,75	4	27.910	65	29,90	3
-	HB 71 T4/T8 (A2:9)	20° - 45°	0,75	4	30.310	68	31,20	3
-	HB 71 T4/T8 (A5:6)	20° - 45°	0,75	4	27.520	79	28,90	3
-	HB 80 T4/T8 (A2:6)	20° - 45°	1,10	7,50	39.010	67	35,40	3
-	HB 80 T4/T8 (A2:9)	20° - 45°	1,10	7,50	41.810	72	36,80	3
-	HB 80 T4/T8 (A5:6)	20° - 45°	1,10	4	37.780	76	34,30	3
-	HB 90 T4/T8 (A6:3)	20° - 42°	3	15	50.950	75	52,10	3
-	HB 90 T4/T8 (A6:6)	20° - 42°	3	15	58.310	76	54,40	3
-	HB 100 T4/T8 (A6:3)	20° - 42°	5,50	20	69.340	76	64,20	3
-	HB 100 T4/T8 (A6:6)	20° - 42°	5,50	20	81.210	80	66,70	3
-	HB 112 T4/T8 (A6:3)	20° - 42°	5,50	37	92.050	78	72,70	3
-	HB 112 T4/T8 (A6:6)	20° - 42°	5,50	37	109.010	83	75,60	3
-	HB 125 T4/T8 (A7:4)	20° - 42°	7,50	44	132.010	85	86	3
-	HB 125 T4/T8 (A7:8)	20° - 42°	11	44	151.010	89	90	3

Notes:

* The motor is not included in fan weight

** Total sound pressure level at the point of maximum flow measured in dB(A) in the suction measured in free field at a distance of 6m from the source

Dimensions

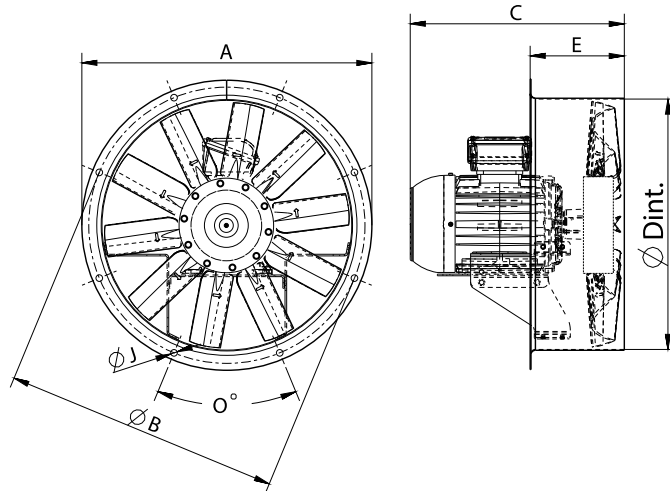

Model	C (Mot. T.63)	C (Mot. T.71)	C (Mot. T.80)	C (Mot. T.90L)	C (Mot. T.90S)	C (Mot. T.100L)	C (Mot. T.112)	C (Mot. T.112M)	C (Mot. T.132)
HB 35 M2 (A0:6)	303	306	335	-	-	-	-	-	-
HB 35 M4 (A0:6)	303	306	335	-	-	-	-	-	-
HB 35 T4 (A0:6)	303	306	335	-	-	-	-	-	-
HB 35 T6 (A0:6)	303	306	335	-	-	-	-	-	-
HB 35 T4/T8 (A0:6)	303	306	335	-	-	-	-	-	-
HB 40 M4 (A0:6)	303	301	335	377	352	-	-	-	-
HB 40 T4 (A0:6)	303	301	335	377	352	-	-	-	-
HB 40 T6 (A0:6)	303	301	335	377	352	-	-	-	-
HB 40 T4/T8 (A0:6)	303	301	335	377	352	-	-	-	-
HB 45 M4 (A0:6)	328	328	347	387	362	418	-	-	-
HB 45 M4 (A5:6)	328	328	347	387	362	418	-	-	-
HB 45 T4 (A0:6)	328	328	347	387	362	418	-	-	-
HB 45 T4 (A5:6)	328	328	347	387	362	418	-	-	-
HB 45 T6 (A0:6)	328	328	347	387	362	418	-	-	-
HB 45 T6 (A5:6)	328	328	347	387	362	418	-	-	-
HB 45 T4/T8 (A0:6)	328	328	347	387	362	418	-	-	-
HB 45 T4/T8 (A5:6)	328	328	347	387	362	418	-	-	-
HB 50 M4 (A0:6)	-	338	350	387	362	421	-	-	-
HB 50 M4 (A5:6)	-	338	350	387	362	421	-	-	-
HB 50 T4 (A0:6)	-	338	350	387	362	421	-	-	-
HB 50 T4 (A5:6)	-	338	350	387	362	421	-	-	-
HB 50 T6 (A0:6)	-	338	350	387	362	421	-	-	-
HB 50 T6 (A5:6)	-	338	350	387	362	421	-	-	-
HB 50 T4/T8 (A0:6)	-	338	350	387	362	421	-	-	-

Model	C (Mot. T.63)	C (Mot. T.71)	C (Mot. T.80)	C (Mot. T.90L)	C (Mot. T.90S)	C (Mot. T.100L)	C (Mot. T.112)	C (Mot. T.112M)	C (Mot. T.132)
HB 50 T4/T8 (A5:6)	-	338	350	387	362	421	-	-	-
HB 56 M4 (A2:6)	-	338	352	387	362	423	-	-	-
HB 56 M4 (A2:9)	-	338	352	387	362	423	-	-	-
HB 56 M4 (A5:6)	-	338	352	387	362	423	-	-	-
HB 56 M6 (A2:6)	-	338	352	387	362	423	-	-	-
HB 56 M6 (A2:9)	-	338	352	387	362	423	-	-	-
HB 56 M6 (A5:6)	-	338	352	387	362	423	-	-	-
HB 56 T4 (A2:6)	-	338	352	387	362	423	-	-	-
HB 56 T4 (A2:9)	-	338	352	387	362	423	-	-	-
HB 56 T4 (A5:6)	-	338	352	387	362	423	-	-	-
HB 56 T6 (A2:6)	-	338	352	387	362	423	-	-	-
HB 56 T6 (A2:9)	-	338	352	387	362	423	-	-	-
HB 56 T6 (A5:6)	-	338	352	387	362	423	-	-	-
HB 56 T4/T8 (A2:6)	-	338	352	387	362	423	-	-	-
HB 56 T4/T8 (A2:9)	-	338	352	387	362	423	-	-	-
HB 56 T4/T8 (A5:6)	-	338	352	387	362	423	-	-	-
HB 63 M4 (A2:6)	-	-	352	411	386	442	-	463	-
HB 63 M4 (A2:9)	-	-	352	411	386	442	-	463	-
HB 63 M4 (A5:6)	-	-	352	411	386	442	-	463	-
HB 63 M6 (A2:6)	-	-	352	411	386	442	-	463	-
HB 63 M6 (A2:9)	-	-	352	411	386	442	-	463	-
HB 63 M6 (A5:6)	-	-	352	411	386	442	-	463	-
HB 63 T4 (A2:6)	-	-	352	411	386	442	-	463	-
HB 63 T4 (A2:9)	-	-	352	411	386	442	-	463	-
HB 63 T4 (A5:6)	-	-	352	411	386	442	-	463	-
HB 63 T6 (A2:6)	-	-	352	411	386	442	-	463	-
HB 63 T6 (A2:9)	-	-	352	411	386	442	-	463	-
HB 63 T6 (A5:6)	-	-	352	411	386	442	-	463	-
HB 63 T4/T8 (A2:6)	-	-	352	411	386	442	-	463	-
HB 63 T4/T8 (A2:9)	-	-	352	411	386	442	-	463	-
HB 63 T4/T8 (A5:6)	-	-	352	411	386	442	-	463	-
HB 71 M4 (A2:6)	-	-	357	416	391	447	-	468	-
HB 71 M4 (A2:9)	-	-	357	416	391	447	-	468	-
HB 71 M4 (A5:6)	-	-	357	416	391	447	-	468	-
HB 71 M6 (A2:6)	-	-	357	416	391	447	-	468	-
HB 71 M6 (A2:9)	-	-	357	416	391	447	-	468	-
HB 71 M6 (A5:6)	-	-	357	416	391	447	-	468	-
HB 71 T4 (A2:6)	-	-	357	416	391	447	-	468	-
HB 71 T4 (A2:9)	-	-	357	416	391	447	-	468	-
HB 71 T4 (A5:6)	-	-	357	416	391	447	-	468	-

Model	C (Mot. T.63)	C (Mot. T.71)	C (Mot. T.80)	C (Mot. T.90L)	C (Mot. T.90S)	C (Mot. T.100L)	C (Mot. T.112)	C (Mot. T.112M)	C (Mot. T.132)
HB 71 T6 (A2:6)	-	-	357	416	391	447	-	468	-
HB 71 T6 (A2:9)	-	-	357	416	391	447	-	468	-
HB 71 T6 (A5:6)	-	-	357	416	391	447	-	468	-
HB 71 T4/T8 (A2:6)	-	-	357	416	391	447	-	468	-
HB 71 T4/T8 (A2:9)	-	-	357	416	391	447	-	468	-
HB 71 T4/T8 (A5:6)	-	-	357	416	391	447	-	468	-
HB 80 T4 (A2:6)	-	-	-	427	427	463	-	469	-
HB 80 T4 (A2:9)	-	-	-	427	427	463	-	469	-
HB 80 T4 (A5:6)	-	-	-	427	427	463	-	469	-
HB 80 T6 (A2:6)	-	-	-	427	427	463	-	469	-
HB 80 T6 (A2:9)	-	-	-	427	427	463	-	469	-
HB 80 T6 (A5:6)	-	-	-	427	427	463	-	469	-
HB 80 T4/T8 (A2:6)	-	-	-	427	427	463	-	469	-
HB 80 T4/T8 (A2:9)	-	-	-	427	427	463	-	469	-
HB 80 T4/T8 (A5:6)	-	-	-	427	427	463	-	469	-
HB 90 T4 (A6:3)	-	-	-	-	-	658	658	-	658
HB 90 T4 (A6:6)	-	-	-	-	-	658	658	-	658
HB 90 T6 (A6:3)	-	-	-	-	-	658	658	-	658
HB 90 T6 (A6:6)	-	-	-	-	-	658	658	-	658
HB 90 T4/T8 (A6:3)	-	-	-	-	-	658	658	-	658
HB 90 T4/T8 (A6:6)	-	-	-	-	-	658	658	-	658
HB 100 T4 (A6:3)	-	-	-	-	-	-	-	-	653
HB 100 T4 (A6:6)	-	-	-	-	-	-	-	-	653
HB 100 T6 (A6:3)	-	-	-	-	-	-	-	-	653
HB 100 T6 (A6:6)	-	-	-	-	-	-	-	-	653
HB 100 T4/T8 (A6:3)	-	-	-	-	-	-	-	-	653
HB 100 T4/T8 (A6:6)	-	-	-	-	-	-	-	-	653
HB 112 T4 (A6:3)	-	-	-	-	-	-	-	-	760
HB 112 T4 (A6:6)	-	-	-	-	-	-	-	-	760
HB 112 T6 (A6:3)	-	-	-	-	-	-	-	-	760
HB 112 T6 (A6:6)	-	-	-	-	-	-	-	-	760
HB 112 T4/T8 (A6:3)	-	-	-	-	-	-	-	-	760
HB 112 T4/T8 (A6:6)	-	-	-	-	-	-	-	-	760
HB 125 T4 (A7:4)	-	-	-	-	-	-	-	-	759
HB 125 T4 (A7:8)	-	-	-	-	-	-	-	-	759
HB 125 T6 (A7:4)	-	-	-	-	-	-	-	-	759
HB 125 T6 (A7:8)	-	-	-	-	-	-	-	-	759
HB 125 T4/T8 (A7:4)	-	-	-	-	-	-	-	-	759
HB 125 T4/T8 (A7:8)	-	-	-	-	-	-	-	-	759

Model	C (Mot. T.132M)	C (Mot. T.132S)	C (Mot. T.160L)	C (Mot. T.160M)	C (Mot. T.180L)	C (Mot. T.180M)	C (Mot. T.200)	C (Mot. T.225)	E
HB 35 M2 (A0:6)	-	-	-	-	-	-	-	-	150
HB 35 M4 (A0:6)	-	-	-	-	-	-	-	-	150
HB 35 T4 (A0:6)	-	-	-	-	-	-	-	-	150
HB 35 T6 (A0:6)	-	-	-	-	-	-	-	-	150
HB 35 T4/T8 (A0:6)	-	-	-	-	-	-	-	-	150
HB 40 M4 (A0:6)	-	-	-	-	-	-	-	-	150
HB 40 T4 (A0:6)	-	-	-	-	-	-	-	-	150
HB 40 T6 (A0:6)	-	-	-	-	-	-	-	-	150
HB 40 T4/T8 (A0:6)	-	-	-	-	-	-	-	-	150
HB 45 M4 (A0:6)	-	-	-	-	-	-	-	-	165
HB 45 M4 (A5:6)	-	-	-	-	-	-	-	-	165
HB 45 T4 (A0:6)	-	-	-	-	-	-	-	-	165
HB 45 T4 (A5:6)	-	-	-	-	-	-	-	-	165
HB 45 T6 (A0:6)	-	-	-	-	-	-	-	-	165
HB 45 T6 (A5:6)	-	-	-	-	-	-	-	-	165
HB 45 T4/T8 (A0:6)	-	-	-	-	-	-	-	-	165
HB 45 T4/T8 (A5:6)	-	-	-	-	-	-	-	-	165
HB 50 M4 (A0:6)	-	-	-	-	-	-	-	-	165
HB 50 M4 (A5:6)	-	-	-	-	-	-	-	-	165
HB 50 T4 (A0:6)	-	-	-	-	-	-	-	-	165
HB 50 T4 (A5:6)	-	-	-	-	-	-	-	-	165
HB 50 T6 (A0:6)	-	-	-	-	-	-	-	-	165
HB 50 T6 (A5:6)	-	-	-	-	-	-	-	-	165
HB 50 T4/T8 (A0:6)	-	-	-	-	-	-	-	-	165
HB 50 T4/T8 (A5:6)	-	-	-	-	-	-	-	-	165
HB 56 M4 (A2:6)	-	-	-	-	-	-	-	-	175
HB 56 M4 (A2:9)	-	-	-	-	-	-	-	-	175
HB 56 M4 (A5:6)	-	-	-	-	-	-	-	-	175
HB 56 M6 (A2:6)	-	-	-	-	-	-	-	-	175
HB 56 M6 (A2:9)	-	-	-	-	-	-	-	-	175
HB 56 M6 (A5:6)	-	-	-	-	-	-	-	-	175
HB 56 T4 (A2:6)	-	-	-	-	-	-	-	-	175
HB 56 T4 (A2:9)	-	-	-	-	-	-	-	-	175
HB 56 T4 (A5:6)	-	-	-	-	-	-	-	-	175
HB 56 T6 (A2:6)	-	-	-	-	-	-	-	-	175
HB 56 T6 (A2:9)	-	-	-	-	-	-	-	-	175
HB 56 T6 (A5:6)	-	-	-	-	-	-	-	-	175
HB 56 T4/T8 (A2:6)	-	-	-	-	-	-	-	-	175
HB 56 T4/T8 (A2:9)	-	-	-	-	-	-	-	-	175
HB 56 T4/T8 (A5:6)	-	-	-	-	-	-	-	-	175

Model	C (Mot. T.132M)	C (Mot. T.132S)	C (Mot. T.160L)	C (Mot. T.160M)	C (Mot. T.180L)	C (Mot. T.180M)	C (Mot. T.200)	C (Mot. T.225)	E
HB 63 M4 (A2:6)	-	-	-	-	-	-	-	-	185
HB 63 M4 (A2:9)	-	-	-	-	-	-	-	-	185
HB 63 M4 (A5:6)	-	-	-	-	-	-	-	-	185
HB 63 M6 (A2:6)	-	-	-	-	-	-	-	-	185
HB 63 M6 (A2:9)	-	-	-	-	-	-	-	-	185
HB 63 M6 (A5:6)	-	-	-	-	-	-	-	-	185
HB 63 T4 (A2:6)	-	-	-	-	-	-	-	-	185
HB 63 T4 (A2:9)	-	-	-	-	-	-	-	-	185
HB 63 T4 (A5:6)	-	-	-	-	-	-	-	-	185
HB 63 T6 (A2:6)	-	-	-	-	-	-	-	-	185
HB 63 T6 (A2:9)	-	-	-	-	-	-	-	-	185
HB 63 T6 (A5:6)	-	-	-	-	-	-	-	-	185
HB 63 T4/T8 (A2:6)	-	-	-	-	-	-	-	-	185
HB 63 T4/T8 (A2:9)	-	-	-	-	-	-	-	-	185
HB 63 T4/T8 (A5:6)	-	-	-	-	-	-	-	-	185
HB 71 M4 (A2:6)	-	-	-	-	-	-	-	-	190
HB 71 M4 (A2:9)	-	-	-	-	-	-	-	-	190
HB 71 M4 (A5:6)	-	-	-	-	-	-	-	-	190
HB 71 M6 (A2:6)	-	-	-	-	-	-	-	-	190
HB 71 M6 (A2:9)	-	-	-	-	-	-	-	-	190
HB 71 M6 (A5:6)	-	-	-	-	-	-	-	-	190
HB 71 T4 (A2:6)	-	-	-	-	-	-	-	-	190
HB 71 T4 (A2:9)	-	-	-	-	-	-	-	-	190
HB 71 T4 (A5:6)	-	-	-	-	-	-	-	-	190
HB 71 T6 (A2:6)	-	-	-	-	-	-	-	-	190
HB 71 T6 (A2:9)	-	-	-	-	-	-	-	-	190
HB 71 T6 (A5:6)	-	-	-	-	-	-	-	-	190
HB 71 T4/T8 (A2:6)	-	-	-	-	-	-	-	-	190
HB 71 T4/T8 (A2:9)	-	-	-	-	-	-	-	-	190
HB 71 T4/T8 (A5:6)	-	-	-	-	-	-	-	-	190
HB 80 T4 (A2:6)	563	525	-	-	-	-	-	-	220
HB 80 T4 (A2:9)	563	525	-	-	-	-	-	-	220
HB 80 T4 (A5:6)	563	525	-	-	-	-	-	-	220
HB 80 T6 (A2:6)	563	525	-	-	-	-	-	-	220
HB 80 T6 (A2:9)	563	525	-	-	-	-	-	-	220
HB 80 T6 (A5:6)	563	525	-	-	-	-	-	-	220
HB 80 T4/T8 (A2:6)	563	525	-	-	-	-	-	-	220
HB 80 T4/T8 (A2:9)	563	525	-	-	-	-	-	-	220
HB 80 T4/T8 (A5:6)	563	525	-	-	-	-	-	-	220
HB 90 T4 (A6:3)	-	-	742	721	787	778	-	-	340

Model	C (Mot. T.132M)	C (Mot. T.132S)	C (Mot. T.160L)	C (Mot. T.160M)	C (Mot. T.180L)	C (Mot. T.180M)	C (Mot. T.200)	C (Mot. T.225)	E
HB 90 T4 (A6:6)	-	-	742	721	787	778	-	-	340
HB 90 T6 (A6:3)	-	-	742	721	787	778	-	-	340
HB 90 T6 (A6:6)	-	-	742	721	787	778	-	-	340
HB 90 T4/T8 (A6:3)	-	-	742	721	787	778	-	-	340
HB 90 T4/T8 (A6:6)	-	-	742	721	787	778	-	-	340
HB 100 T4 (A6:3)	-	-	738	716	792	776	-	-	340
HB 100 T4 (A6:6)	-	-	738	716	792	776	-	-	340
HB 100 T6 (A6:3)	-	-	738	716	792	776	-	-	340
HB 100 T6 (A6:6)	-	-	738	716	792	776	-	-	340
HB 100 T4/T8 (A6:3)	-	-	738	716	792	776	-	-	340
HB 100 T4/T8 (A6:6)	-	-	738	716	792	776	-	-	340
HB 112 T4 (A6:3)	-	-	760	760	780	761	864	949	340
HB 112 T4 (A6:6)	-	-	760	760	780	761	864	949	340
HB 112 T6 (A6:3)	-	-	760	760	780	761	864	949	340
HB 112 T6 (A6:6)	-	-	760	760	780	761	864	949	340
HB 112 T4/T8 (A6:3)	-	-	760	760	780	761	864	949	340
HB 112 T4/T8 (A6:6)	-	-	760	760	780	761	864	949	340
HB 125 T4 (A7:4)	-	-	759	759	779	760	863	948	340
HB 125 T4 (A7:8)	-	-	759	759	779	760	863	948	340
HB 125 T6 (A7:4)	-	-	759	759	779	760	863	948	340
HB 125 T6 (A7:8)	-	-	759	759	779	760	863	948	340
HB 125 T4/T8 (A7:4)	-	-	759	759	779	760	863	948	340
HB 125 T4/T8 (A7:8)	-	-	759	759	779	760	863	948	340

Model	O	ØA	ØB	ØD	ØJ
HB 35 M2 (A0:6)	8x45°	434	395	365	10
HB 35 M4 (A0:6)	8x45°	434	395	365	10
HB 35 T4 (A0:6)	8x45°	434	395	365	10
HB 35 T6 (A0:6)	8x45°	434	395	365	10
HB 35 T4/T8 (A0:6)	8x45°	434	395	365	10
HB 40 M4 (A0:6)	8x45°	472	450	403	10
HB 40 T4 (A0:6)	8x45°	472	450	403	10
HB 40 T6 (A0:6)	8x45°	472	450	403	10
HB 40 T4/T8 (A0:6)	8x45°	472	450	403	10
HB 45 M4 (A0:6)	8x45°	525	500	452	12
HB 45 M4 (A5:6)	8x45°	525	500	452	12
HB 45 T4 (A0:6)	8x45°	525	500	452	12
HB 45 T4 (A5:6)	8x45°	525	500	452	12
HB 45 T6 (A0:6)	8x45°	525	500	452	12
HB 45 T6 (A5:6)	8x45°	525	500	452	12

Model	O	ØA	ØB	ØD	ØJ
HB 45 T4/T8 (A0:6)	8X45 ^º	525	500	452	12
HB 45 T4/T8 (A5:6)	8X45 ^º	525	500	452	12
HB 50 M4 (A0:6)	12x30 ^º	600	560	504	12
HB 50 M4 (A5:6)	12x30 ^º	600	560	504	12
HB 50 T4 (A0:6)	12x30 ^º	600	560	504	12
HB 50 T4 (A5:6)	12x30 ^º	600	560	504	12
HB 50 T6 (A0:6)	12x30 ^º	600	560	504	12
HB 50 T6 (A5:6)	12x30 ^º	600	560	504	12
HB 50 T4/T8 (A0:6)	12x30 ^º	600	560	504	12
HB 50 T4/T8 (A5:6)	12x30 ^º	600	560	504	12
HB 56 M4 (A2:6)	12X30 ^º	646	620	559	12
HB 56 M4 (A2:9)	12X30 ^º	646	620	559	12
HB 56 M4 (A5:6)	12X30 ^º	646	620	559	12
HB 56 M6 (A2:6)	12X30 ^º	646	620	559	12
HB 56 M6 (A2:9)	12X30 ^º	646	620	559	12
HB 56 M6 (A5:6)	12X30 ^º	646	620	559	12
HB 56 T4 (A2:6)	12X30 ^º	646	620	559	12
HB 56 T4 (A2:9)	12X30 ^º	646	620	559	12
HB 56 T4 (A5:6)	12X30 ^º	646	620	559	12
HB 56 T6 (A2:6)	12X30 ^º	646	620	559	12
HB 56 T6 (A2:9)	12X30 ^º	646	620	559	12
HB 56 T6 (A5:6)	12X30 ^º	646	620	559	12
HB 56 T4/T8 (A2:6)	12X30 ^º	646	620	559	12
HB 56 T4/T8 (A2:9)	12X30 ^º	646	620	559	12
HB 56 T4/T8 (A5:6)	12X30 ^º	646	620	559	12
HB 63 M4 (A2:6)	12X30 ^º	725	690	633	12
HB 63 M4 (A2:9)	12X30 ^º	725	690	633	12
HB 63 M4 (A5:6)	12X30 ^º	725	690	633	12
HB 63 M6 (A2:6)	12X30 ^º	725	690	633	12
HB 63 M6 (A2:9)	12X30 ^º	725	690	633	12
HB 63 M6 (A5:6)	12X30 ^º	725	690	633	12
HB 63 T4 (A2:6)	12X30 ^º	725	690	633	12
HB 63 T4 (A2:9)	12X30 ^º	725	690	633	12
HB 63 T4 (A5:6)	12X30 ^º	725	690	633	12
HB 63 T6 (A2:6)	12X30 ^º	725	690	633	12
HB 63 T6 (A2:9)	12X30 ^º	725	690	633	12
HB 63 T6 (A5:6)	12X30 ^º	725	690	633	12
HB 63 T4/T8 (A2:6)	12X30 ^º	725	690	633	12
HB 63 T4/T8 (A2:9)	12X30 ^º	725	690	633	12
HB 63 T4/T8 (A5:6)	12X30 ^º	725	690	633	12

Model	O	ØA	ØB	ØD	ØJ
HB 71 M4 (A2:6)	16x22,5º	802	770	715	12
HB 71 M4 (A2:9)	16x22,5º	802	770	715	12
HB 71 M4 (A5:6)	16x22,5º	802	770	715	12
HB 71 M6 (A2:6)	16x22,5º	802	770	715	12
HB 71 M6 (A2:9)	16x22,5º	802	770	715	12
HB 71 M6 (A5:6)	16x22,5º	802	770	715	12
HB 71 T4 (A2:6)	16x22,5º	802	770	715	12
HB 71 T4 (A2:9)	16x22,5º	802	770	715	12
HB 71 T4 (A5:6)	16x22,5º	802	770	715	12
HB 71 T6 (A2:6)	16x22,5º	802	770	715	12
HB 71 T6 (A2:9)	16x22,5º	802	770	715	12
HB 71 T6 (A5:6)	16x22,5º	802	770	715	12
HB 71 T4/T8 (A2:6)	16x22,5º	802	770	715	12
HB 71 T4/T8 (A2:9)	16x22,5º	802	770	715	12
HB 71 T4/T8 (A5:6)	16x22,5º	802	770	715	12
HB 80 T4 (A2:6)	16x22,5º	892	860	801	12
HB 80 T4 (A2:9)	16x22,5º	892	860	801	12
HB 80 T4 (A5:6)	16x22,5º	892	860	801	12
HB 80 T6 (A2:6)	16x22,5º	892	860	801	12
HB 80 T6 (A2:9)	16x22,5º	892	860	801	12
HB 80 T6 (A5:6)	16x22,5º	892	860	801	12
HB 80 T4/T8 (A2:6)	16x22,5º	892	860	801	12
HB 80 T4/T8 (A2:9)	16x22,5º	892	860	801	12
HB 80 T4/T8 (A5:6)	16x22,5º	892	860	801	12
HB 90 T4 (A6:3)	16x22,5º	1000	970	903.5	12
HB 90 T4 (A6:6)	16x22,5º	1000	970	903.5	12
HB 90 T6 (A6:3)	16x22,5º	1000	970	903.5	12
HB 90 T6 (A6:6)	16x22,5º	1000	970	903.5	12
HB 90 T4/T8 (A6:3)	16x22,5º	1000	970	903.5	12
HB 90 T4/T8 (A6:6)	16x22,5º	1000	970	903.5	12
HB 100 T4 (A6:3)	16x22,5º	1115	1070	1013	12
HB 100 T4 (A6:6)	16x22,5º	1115	1070	1013	12
HB 100 T6 (A6:3)	16x22,5º	1115	1070	1013	12
HB 100 T6 (A6:6)	16x22,5º	1115	1070	1013	12
HB 100 T4/T8 (A6:3)	16x22,5º	1115	1070	1013	12
HB 100 T4/T8 (A6:6)	16x22,5º	1115	1070	1013	12
HB 112 T4 (A6:3)	16x22,5º	1234	1190	1132	12
HB 112 T4 (A6:6)	16x22,5º	1234	1190	1132	12
HB 112 T6 (A6:3)	16x22,5º	1234	1190	1132	12
HB 112 T6 (A6:6)	16x22,5º	1234	1190	1132	12

Model	O	ØA	ØB	ØD	ØJ
HB 112 T4/T8 (A6:3)	16x22,5º	1234	1190	1132	12
HB 112 T4/T8 (A6:6)	16x22,5º	1234	1190	1132	12
HB 125 T4 (A7:4)	20x18º	1365	1320	1263	15
HB 125 T4 (A7:8)	20x18º	1365	1320	1263	15
HB 125 T6 (A7:4)	20x18º	1365	1320	1263	15
HB 125 T6 (A7:8)	20x18º	1365	1320	1263	15
HB 125 T4/T8 (A7:4)	20x18º	1365	1320	1263	15
HB 125 T4/T8 (A7:8)	20x18º	1365	1320	1263	15

Wiring diagram

DIAGRAM Nº 1

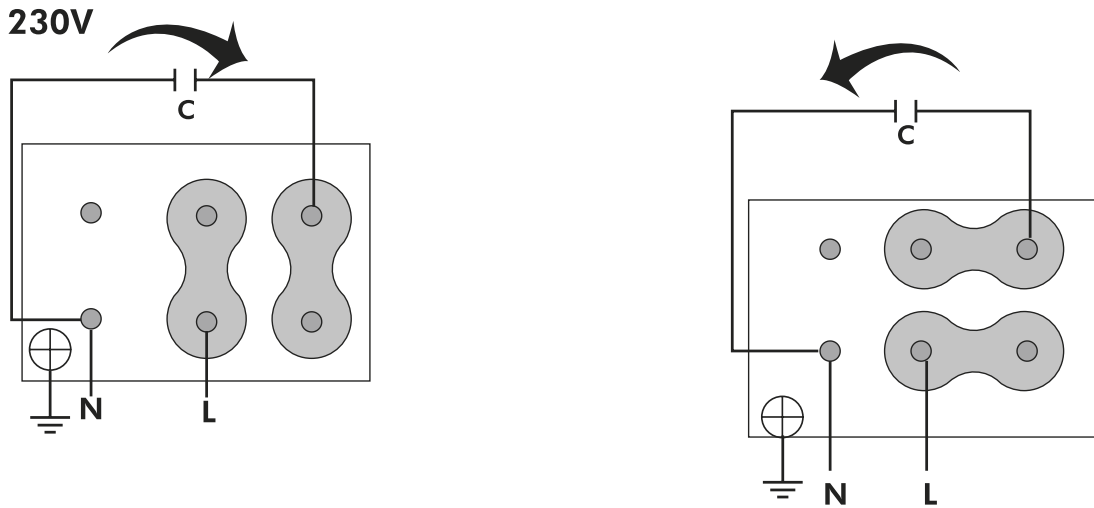

DIAGRAM Nº 2

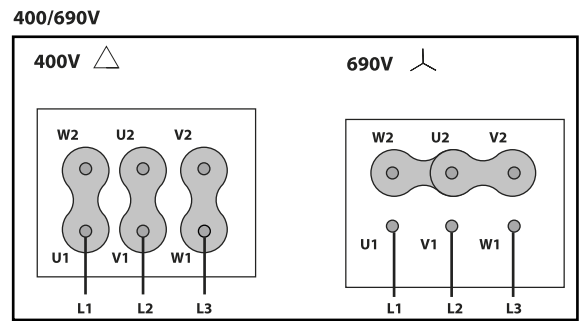
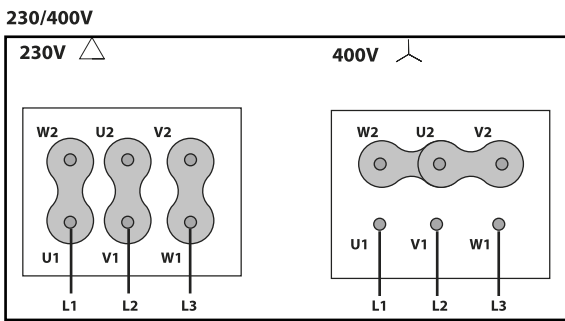
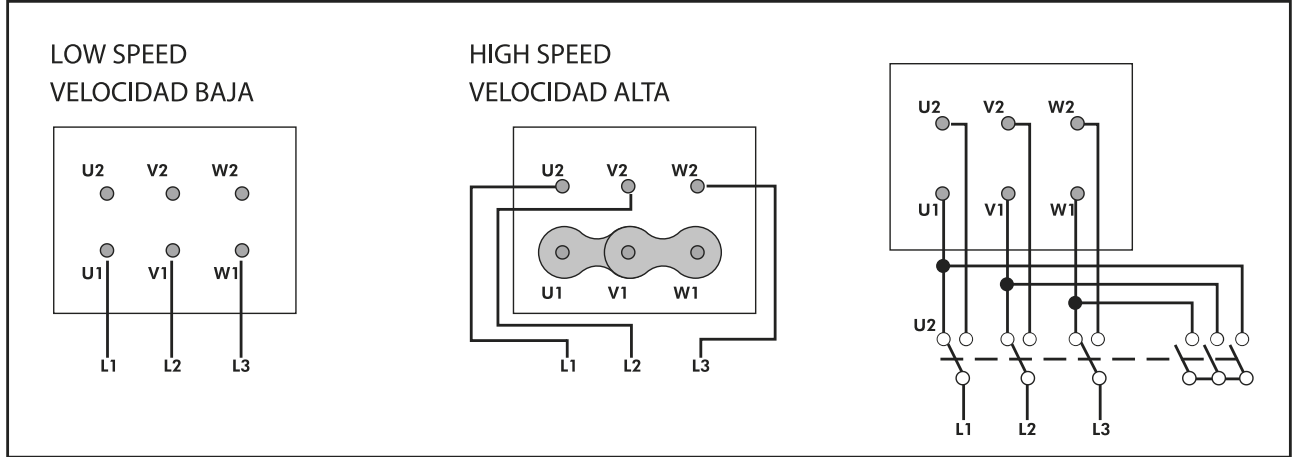

DIAGRAM Nº 3

400V DAHLANDER (Y,YY)



CHARACTERISTIC CURVE

HB 35 M2 (A0:6)

AIR FLOW - PRESSURE

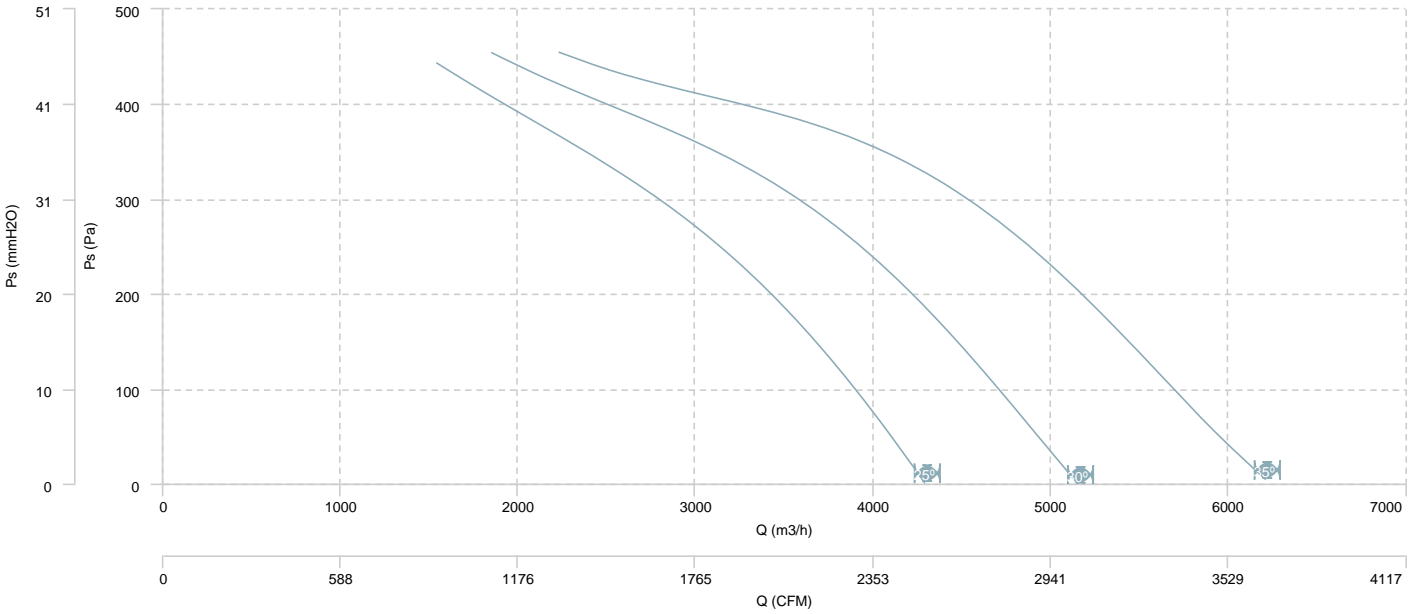

AIR FLOW - MECHANICAL POWER

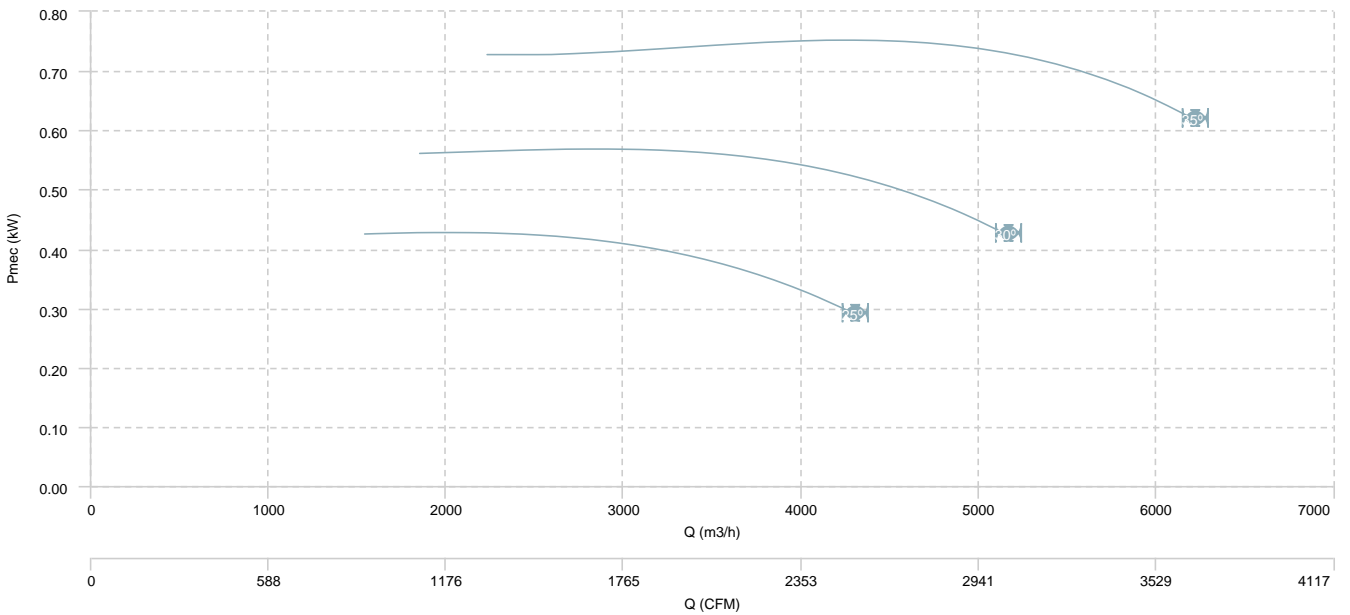

HB 35 M4 (A0:6)

AIR FLOW - PRESSURE

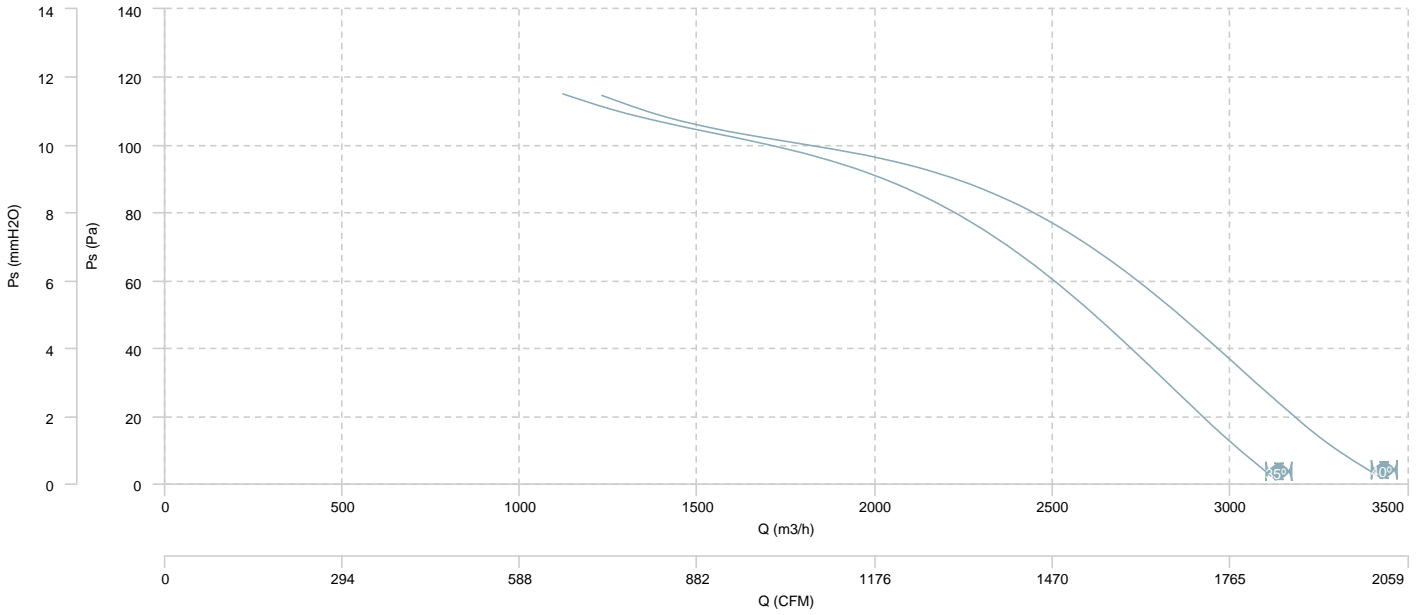

AIR FLOW - MECHANICAL POWER

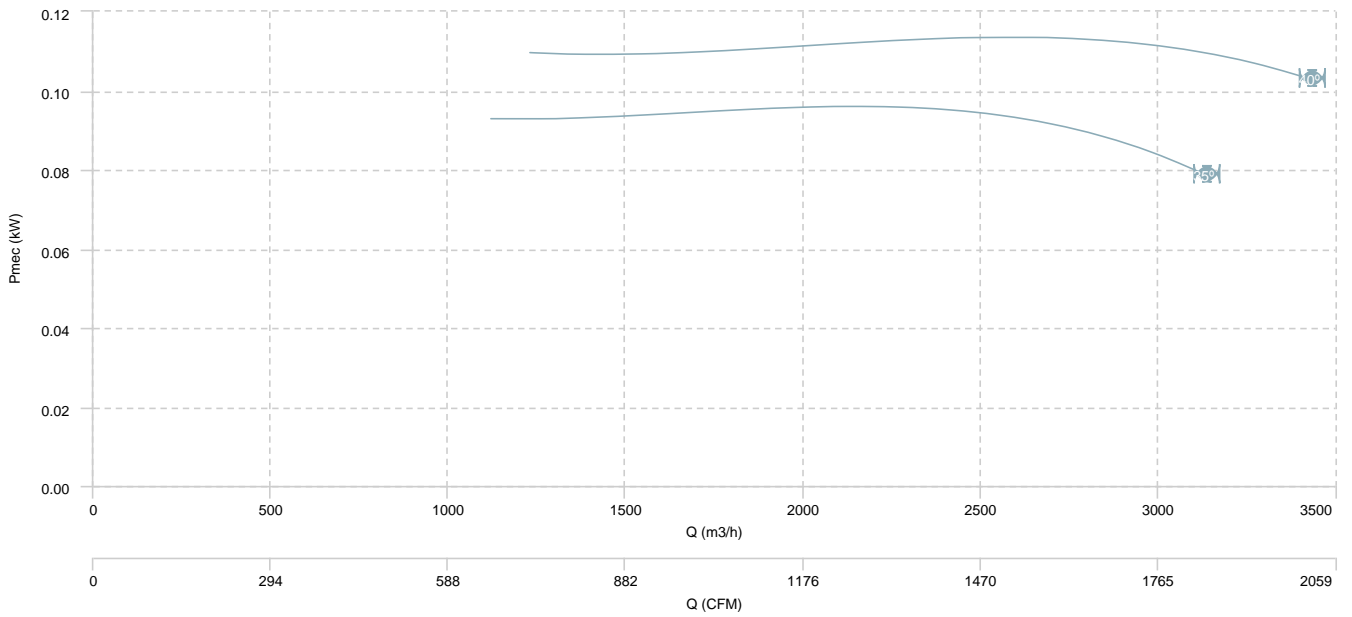

HB 40 M4 (A0:6)

AIR FLOW - PRESSURE

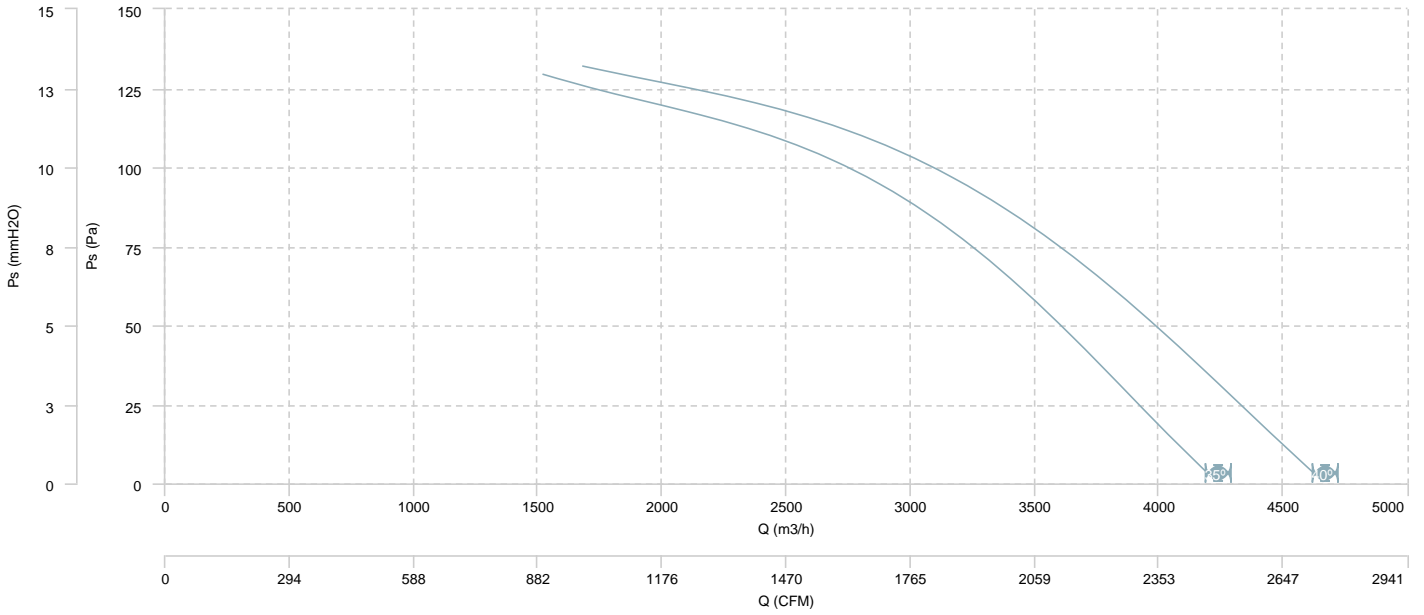

AIR FLOW - MECHANICAL POWER

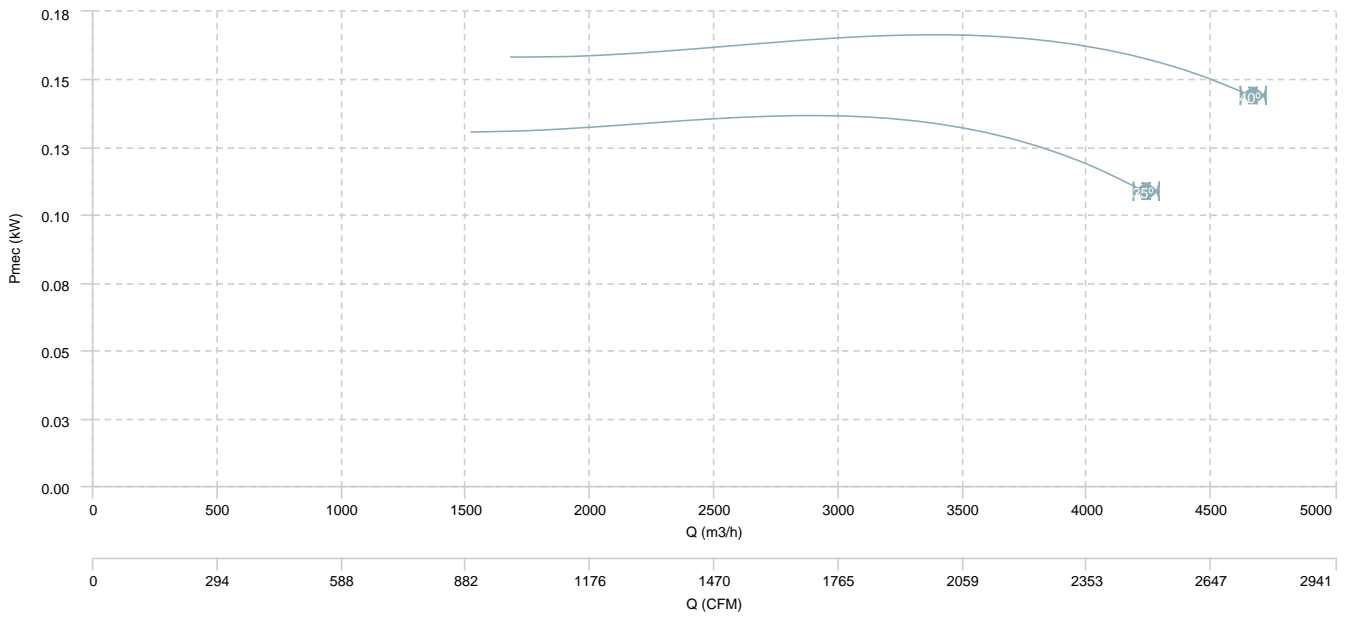

HB 45 M4 (A5:6)

AIR FLOW - PRESSURE

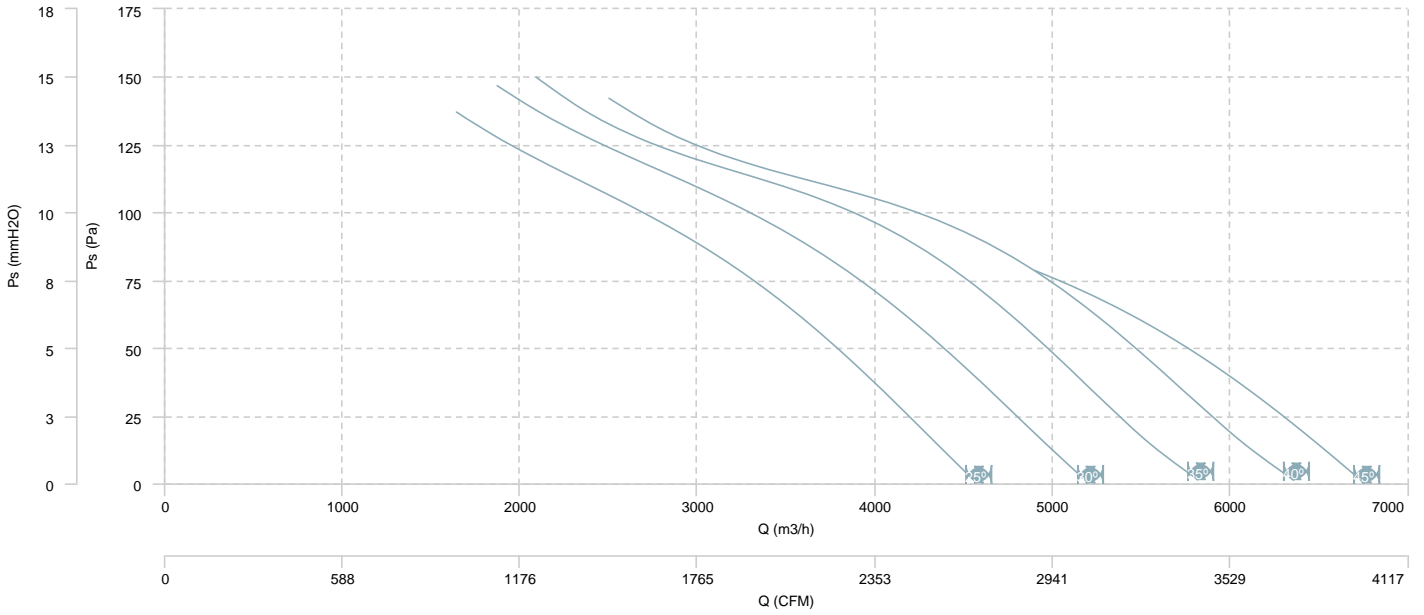

AIR FLOW - MECHANICAL POWER

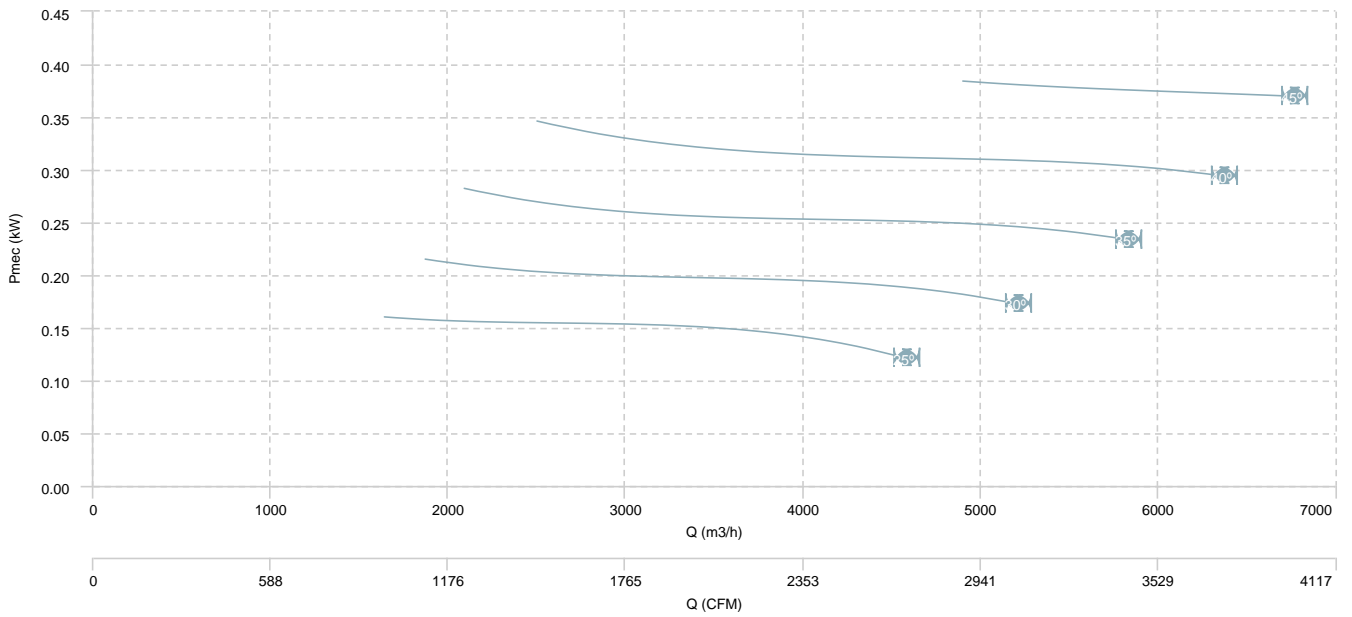

HB 45 M4 (A0:6)

AIR FLOW - PRESSURE

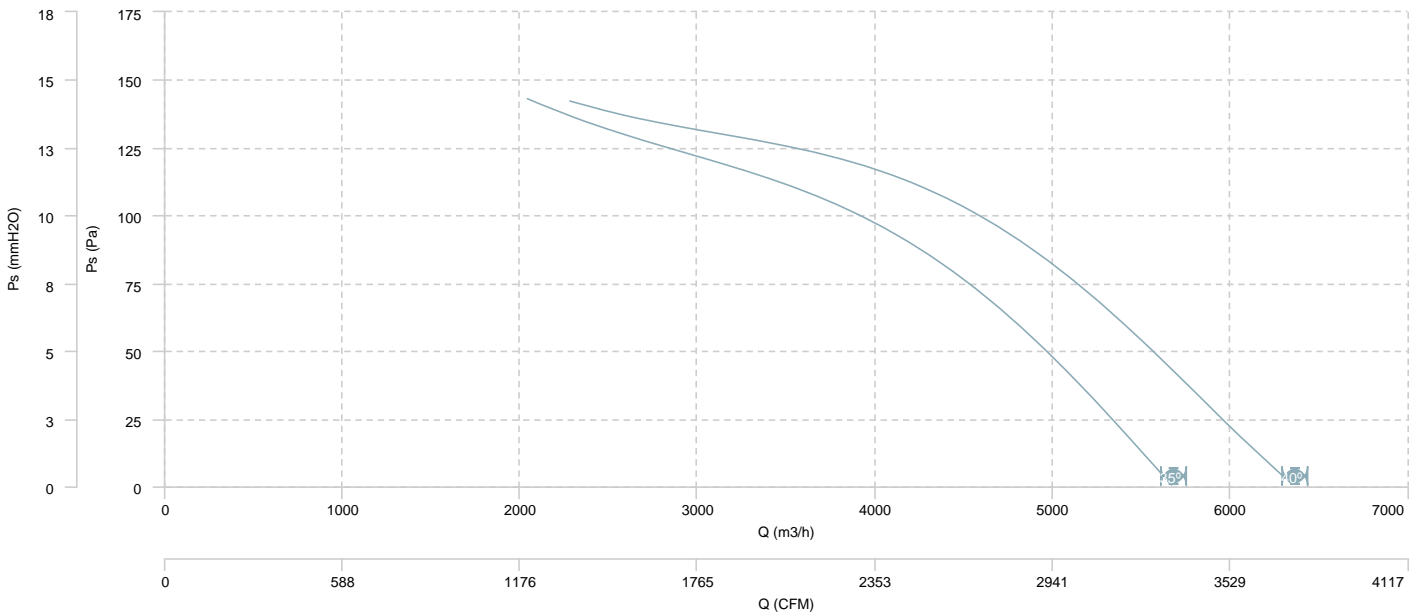

AIR FLOW - MECHANICAL POWER

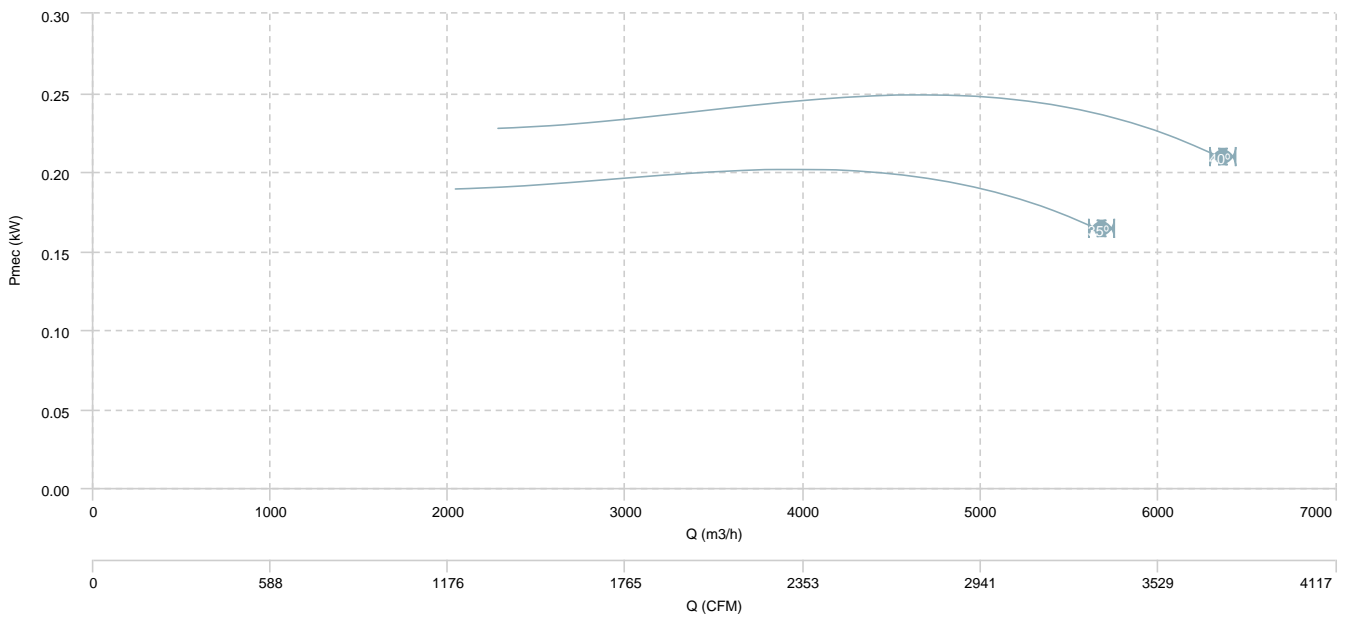

HB 50 M4 (A5:6)

AIR FLOW - PRESSURE

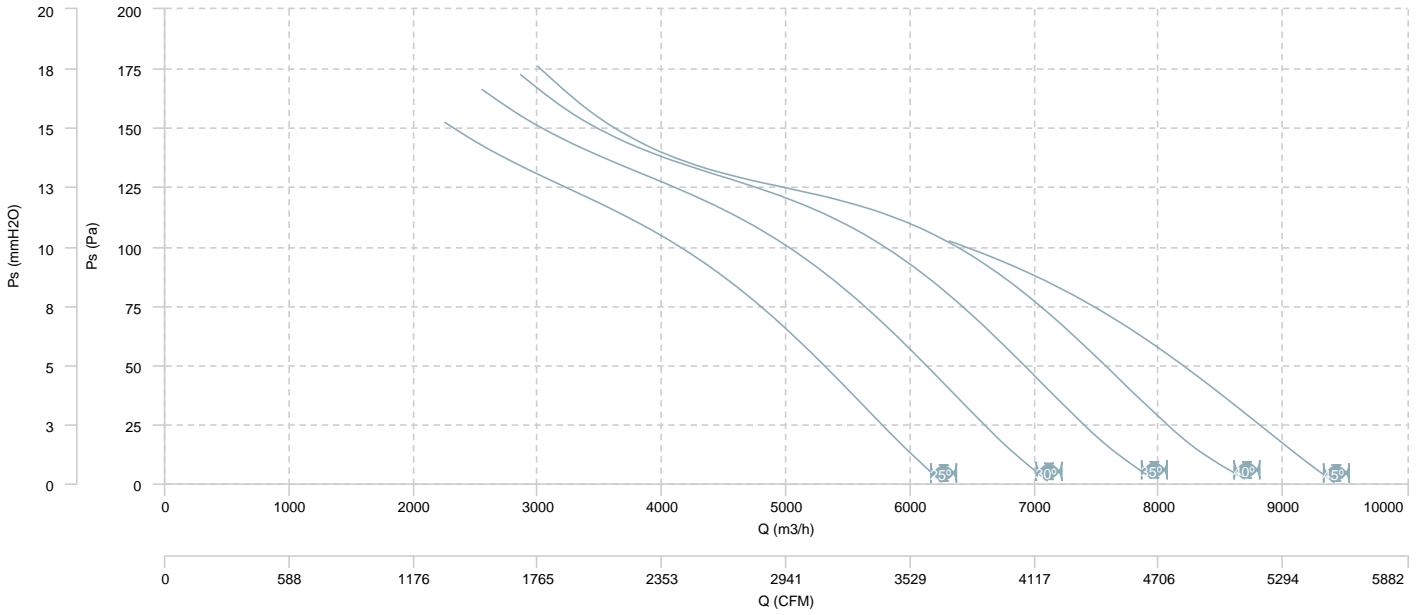

AIR FLOW - MECHANICAL POWER

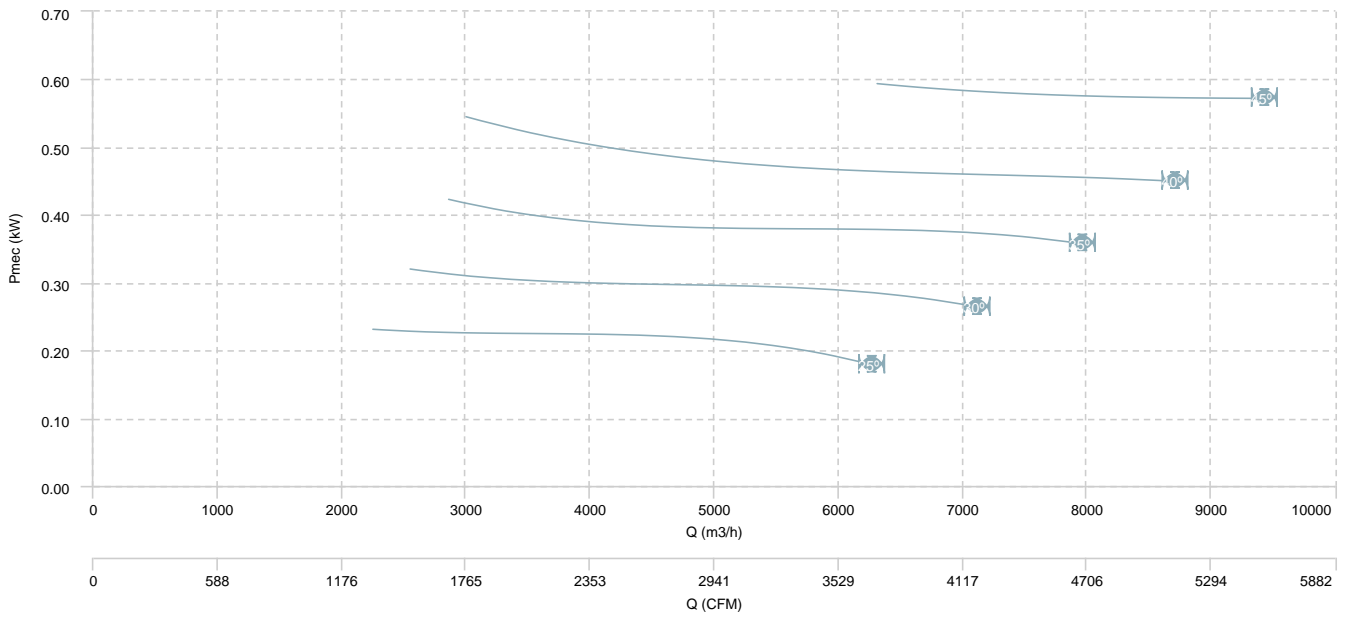

HB 50 M4 (A0:6)

AIR FLOW - PRESSURE

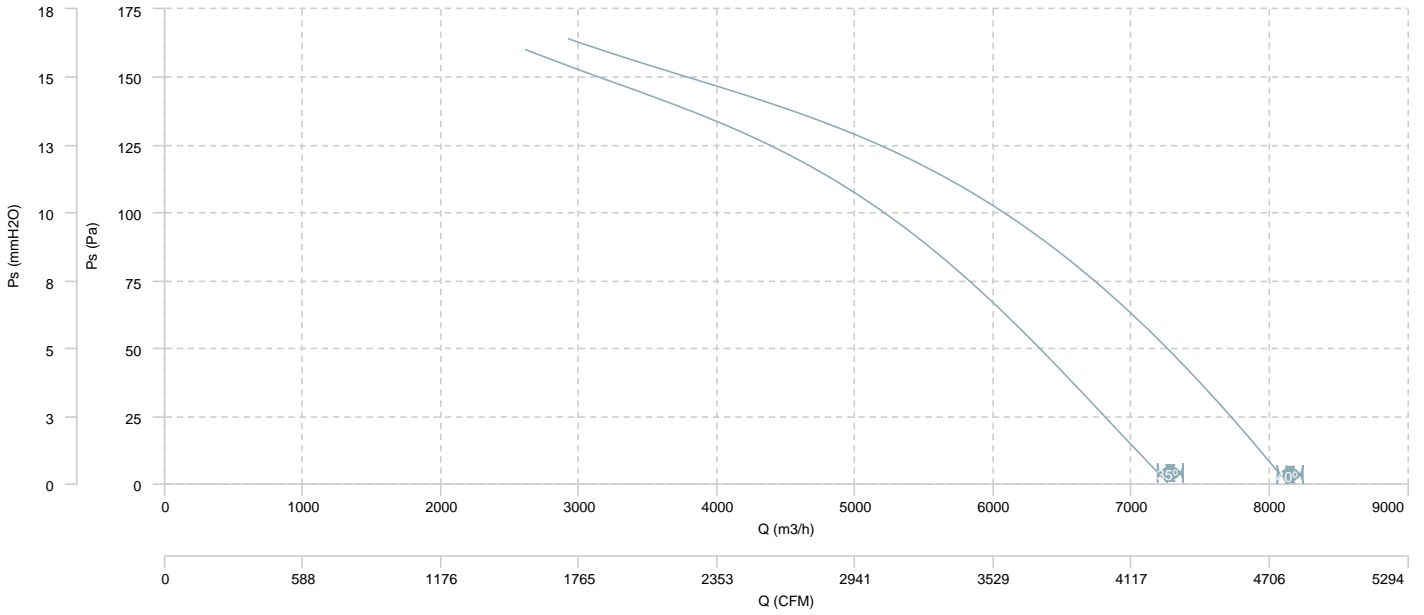

AIR FLOW - MECHANICAL POWER

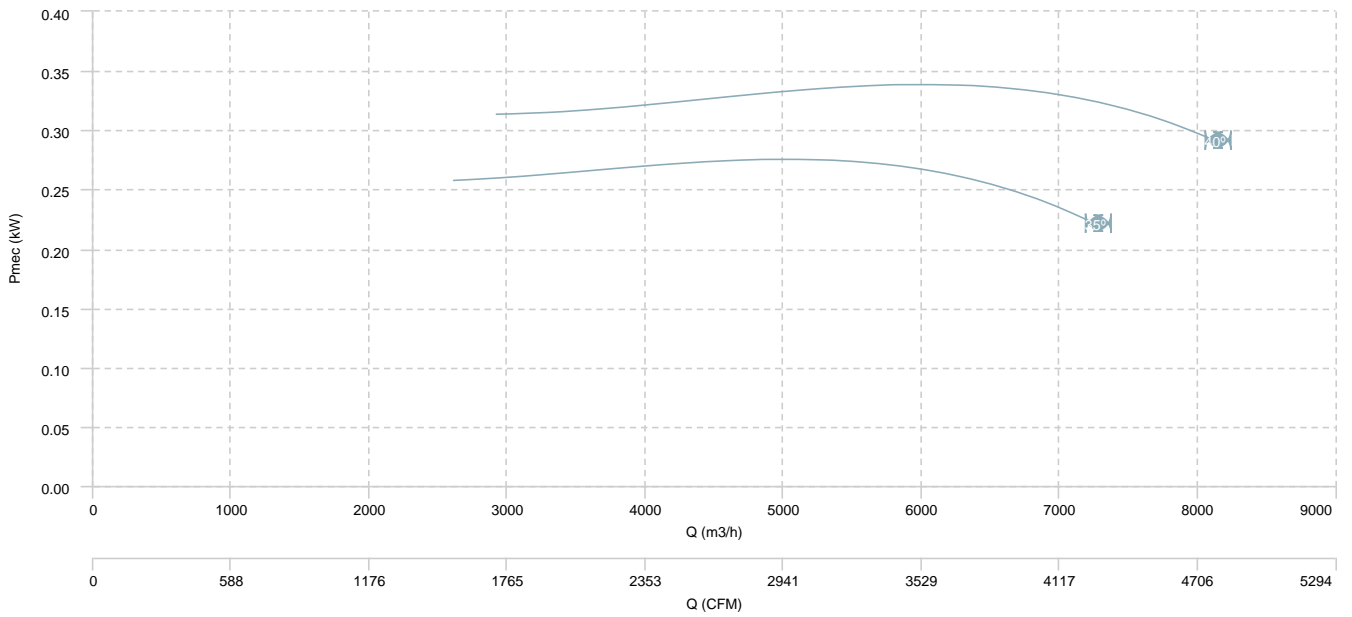

HB 56 M4 (A2:6)

AIR FLOW - PRESSURE

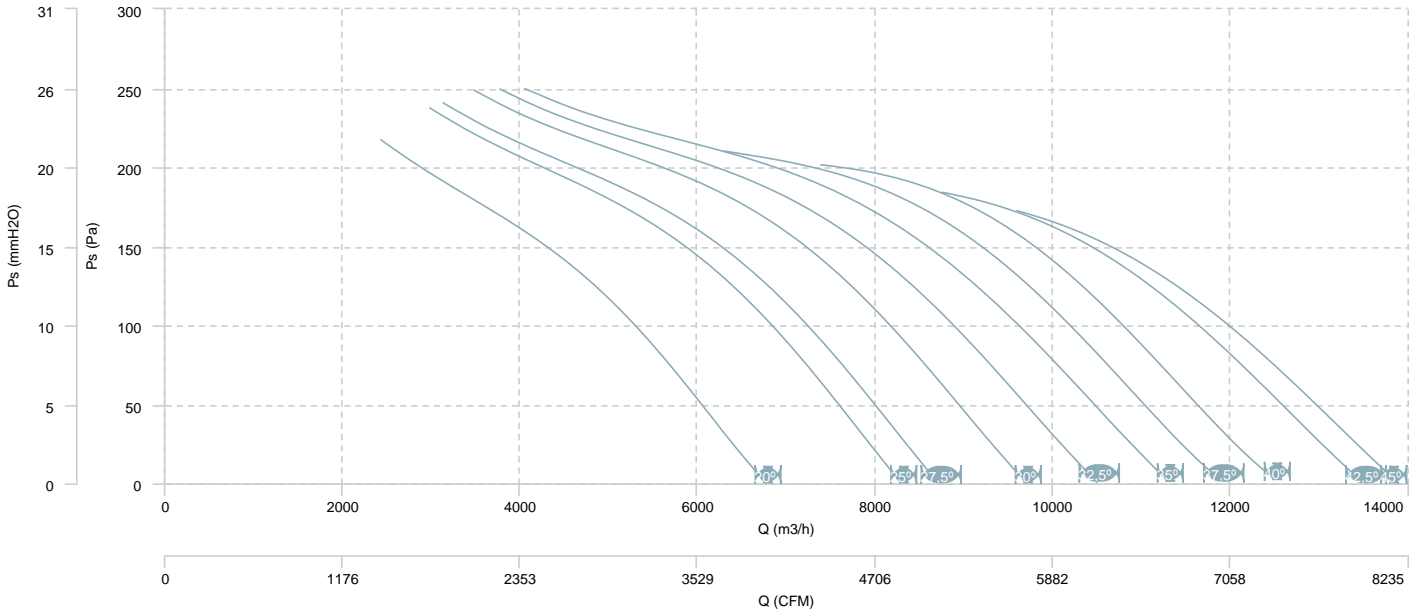

AIR FLOW - MECHANICAL POWER

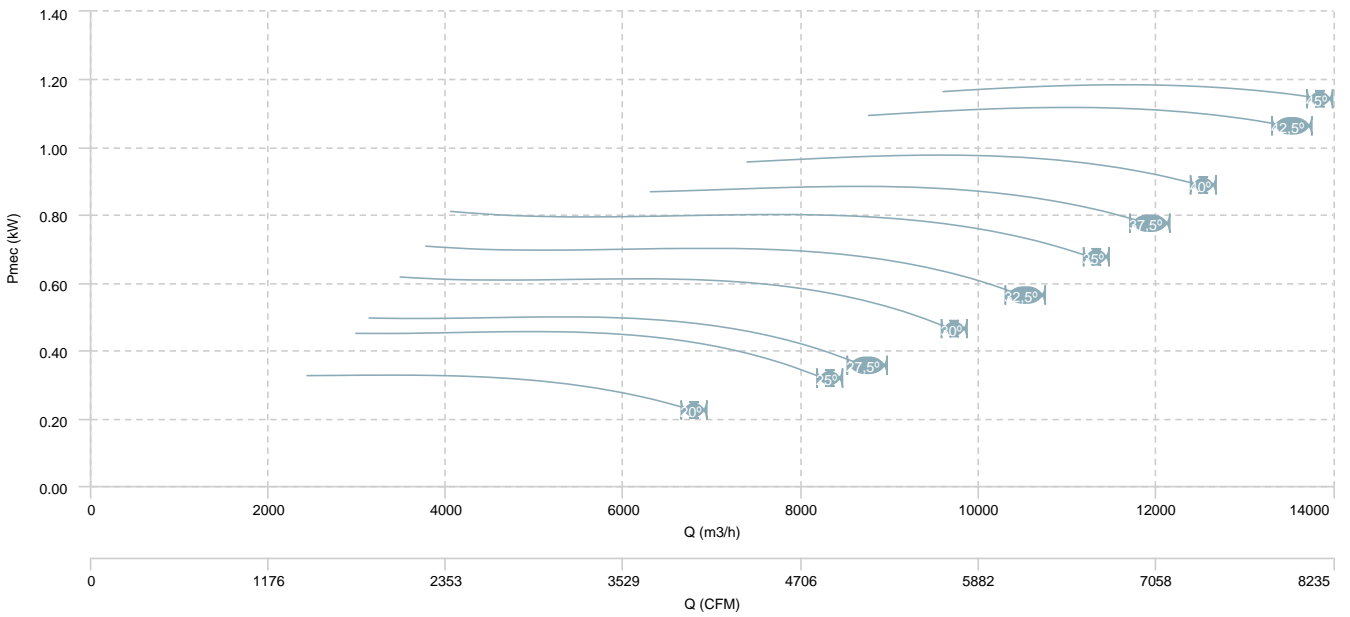

HB 56 M4 (A2:9)

AIR FLOW - PRESSURE

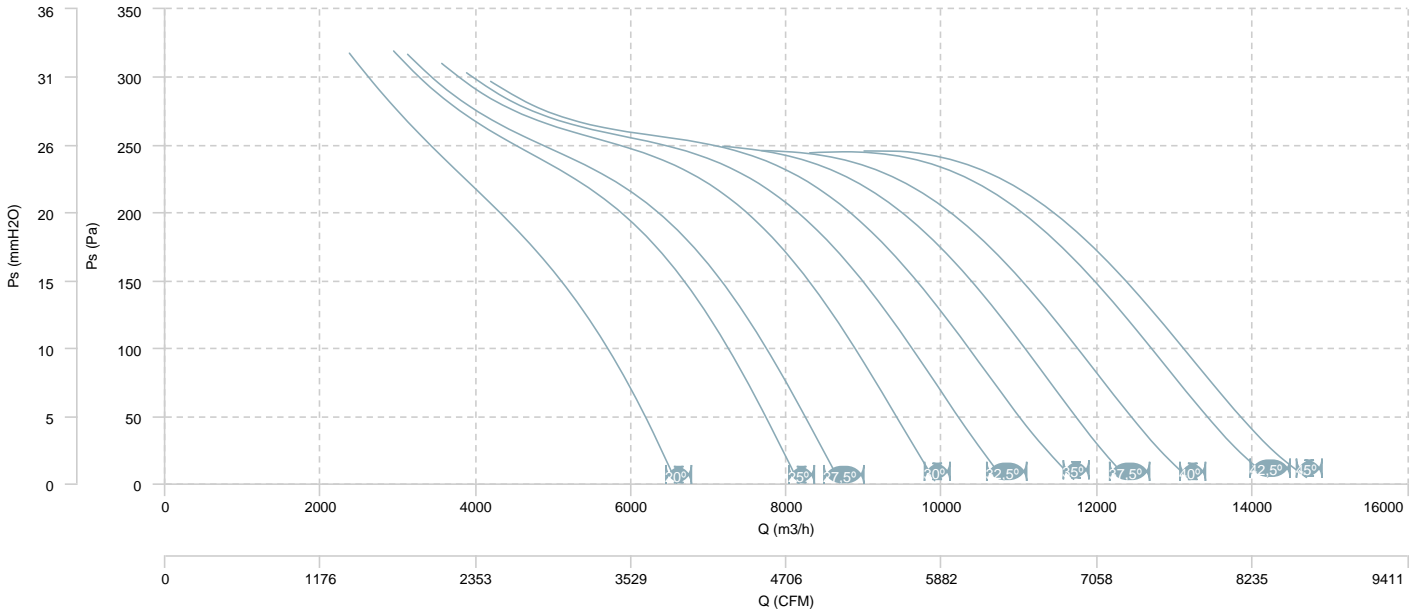

AIR FLOW - MECHANICAL POWER

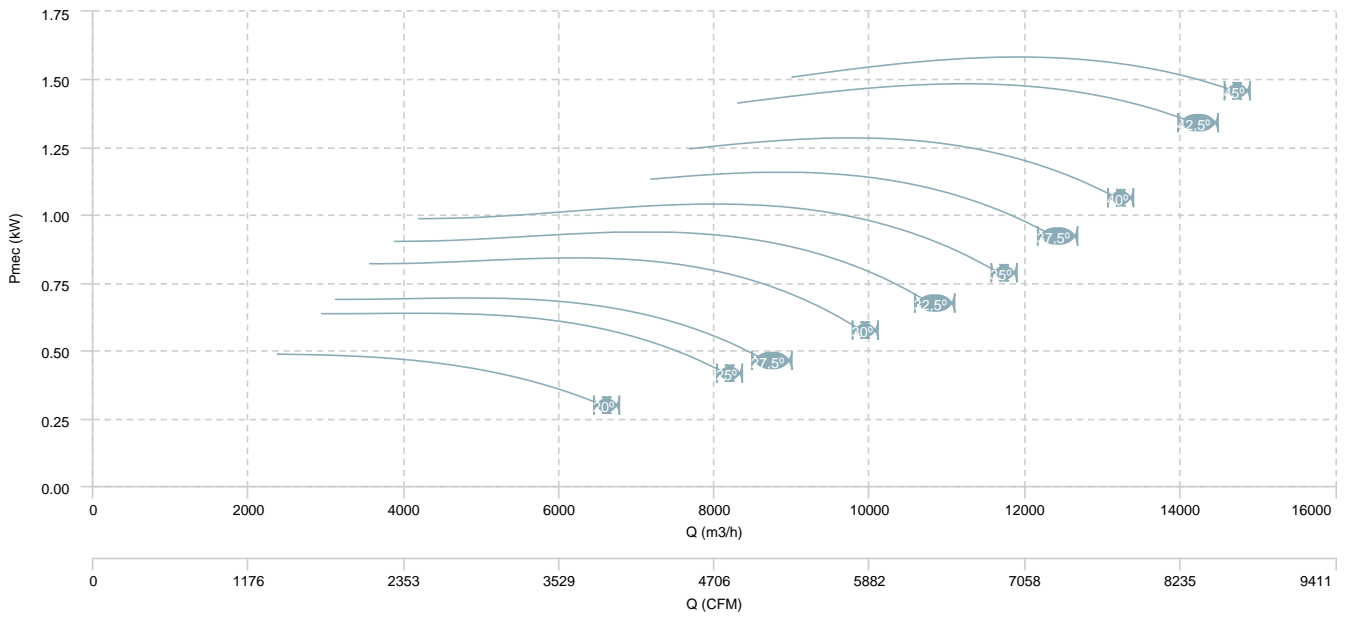

HB 56 M4 (A5:6)

AIR FLOW - PRESSURE

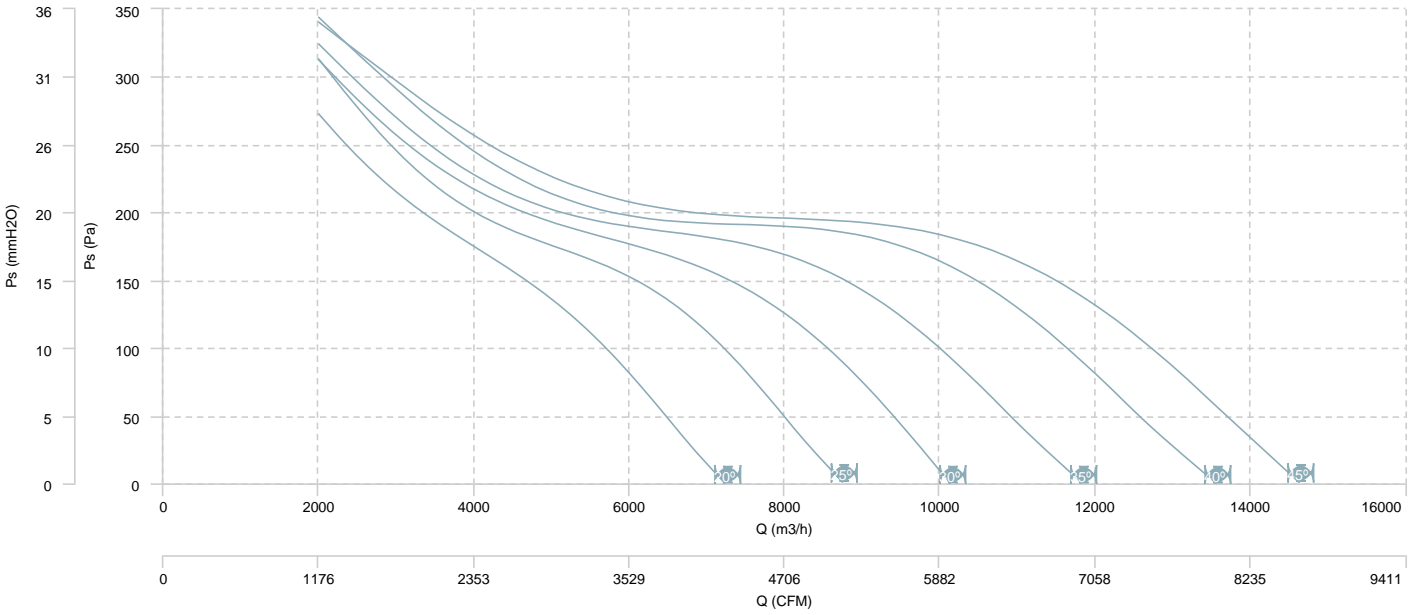

AIR FLOW - MECHANICAL POWER

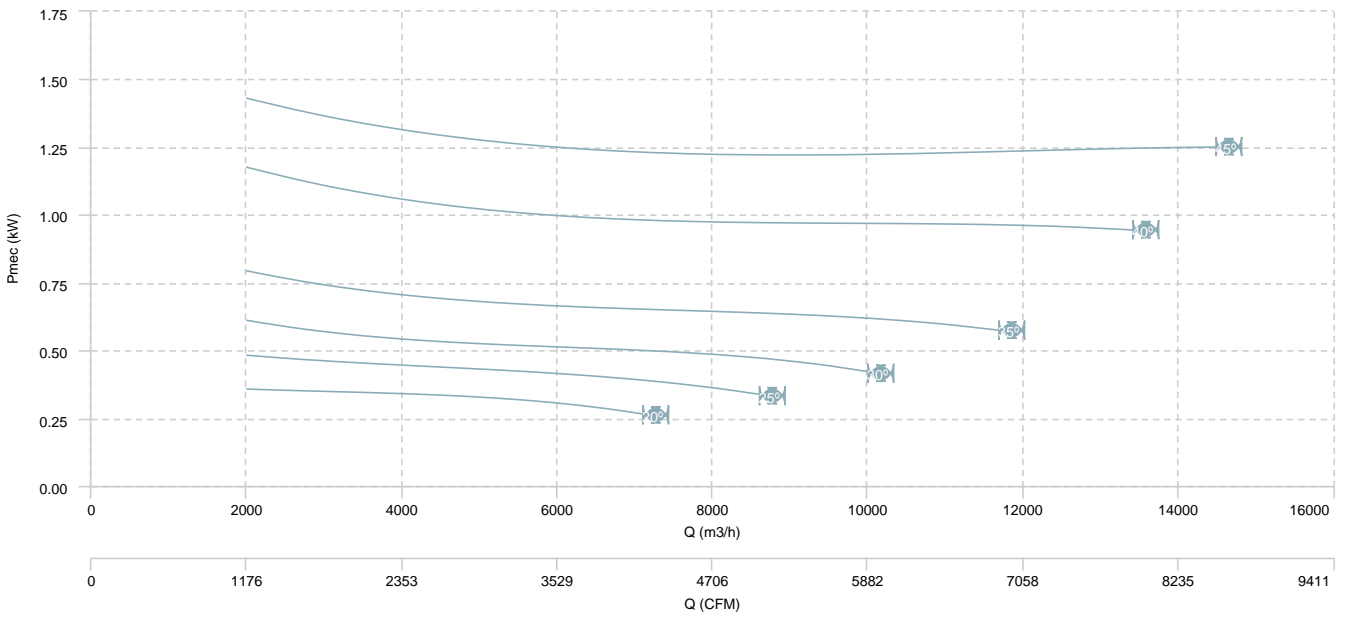

HB 56 M6 (A2:6)

AIR FLOW - PRESSURE

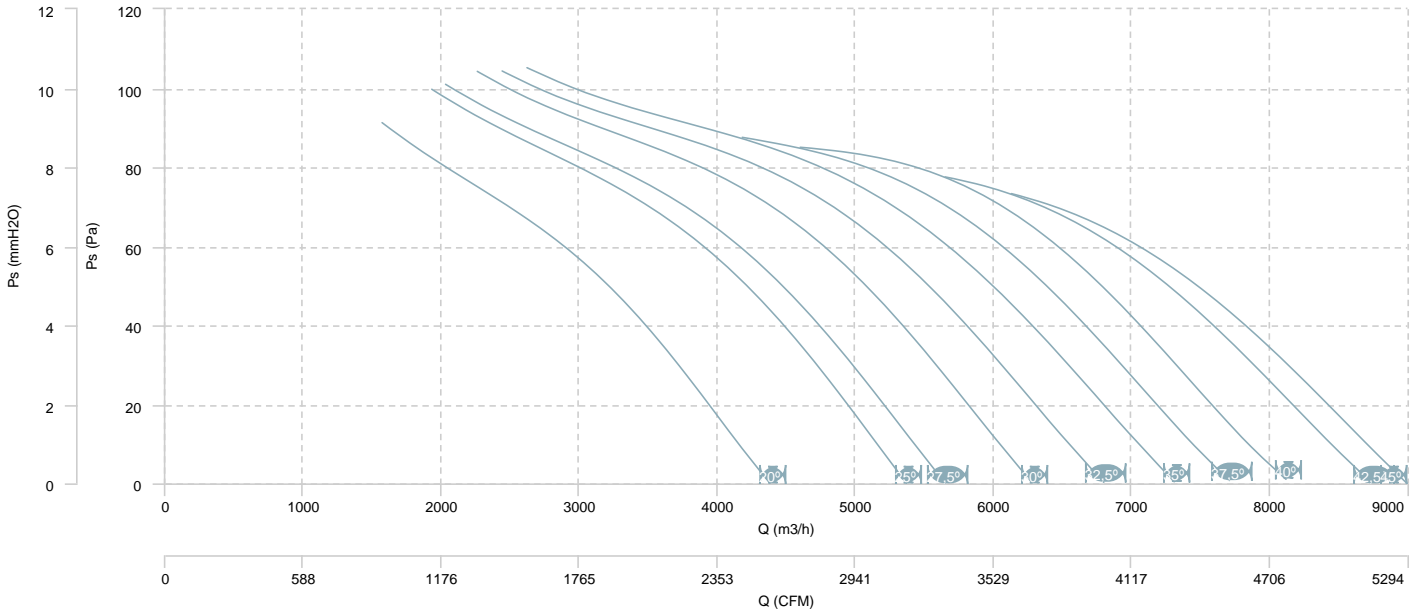

AIR FLOW - MECHANICAL POWER

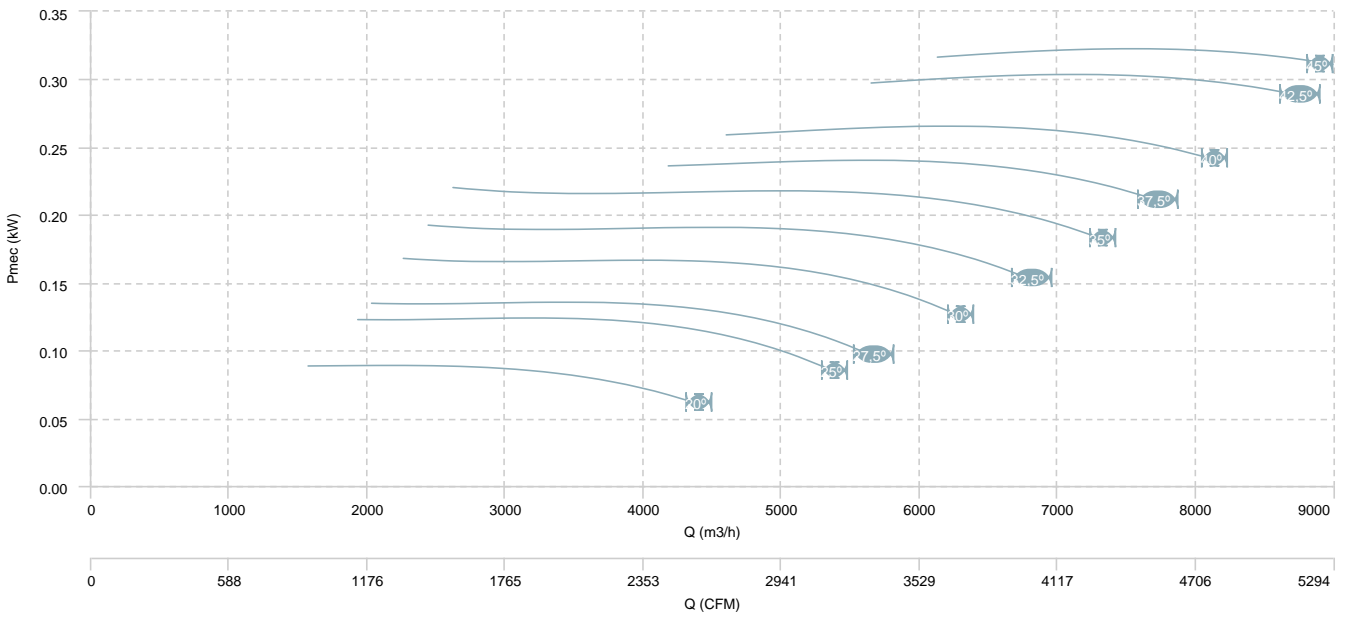

HB 56 M6 (A2:9)

AIR FLOW - PRESSURE

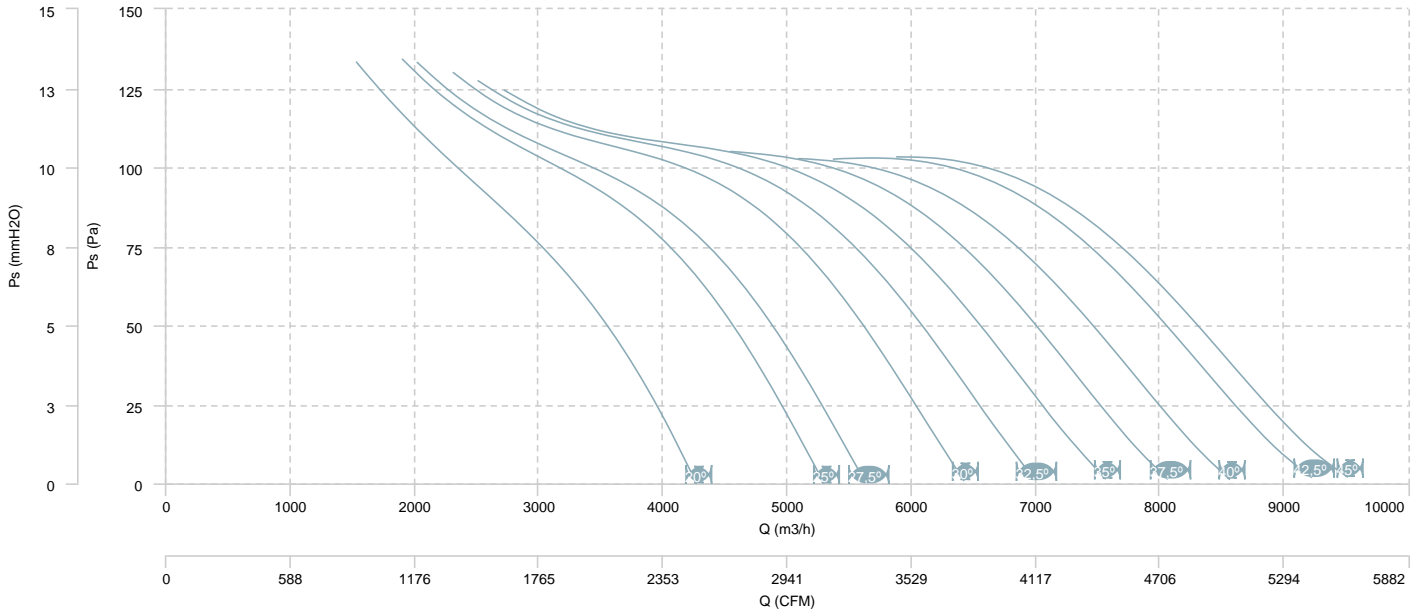

AIR FLOW - MECHANICAL POWER

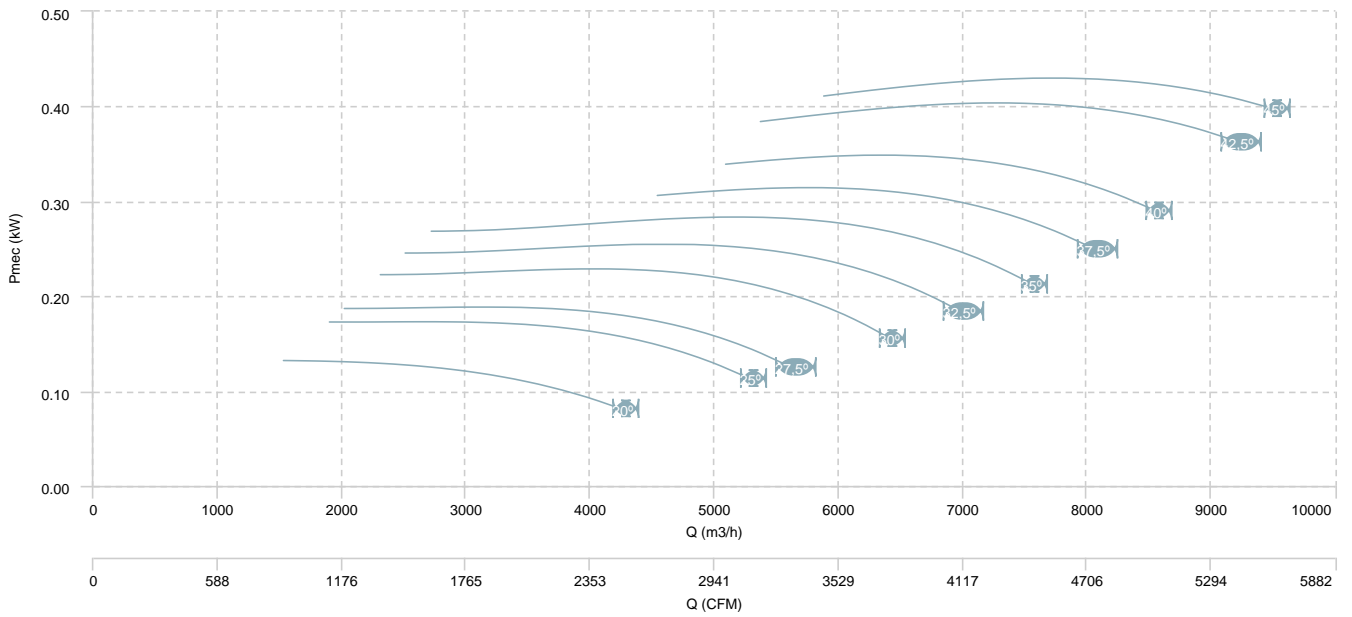

HB 56 M6 (A5:6)

AIR FLOW - PRESSURE

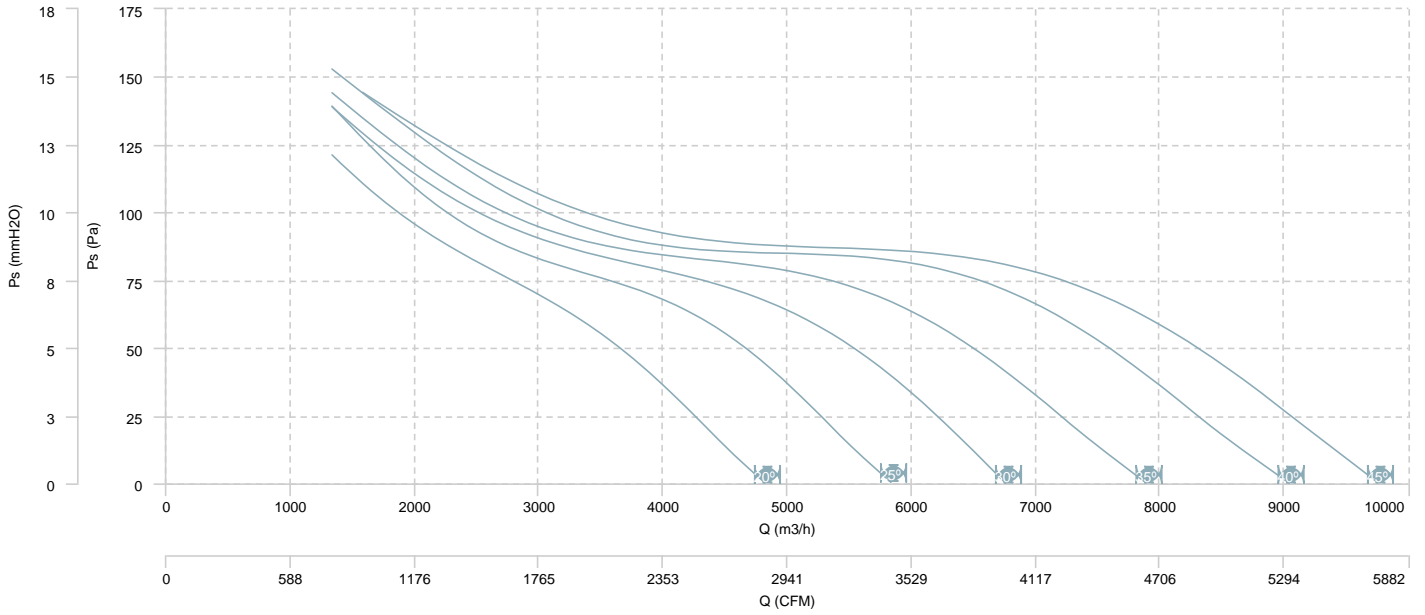

AIR FLOW - MECHANICAL POWER

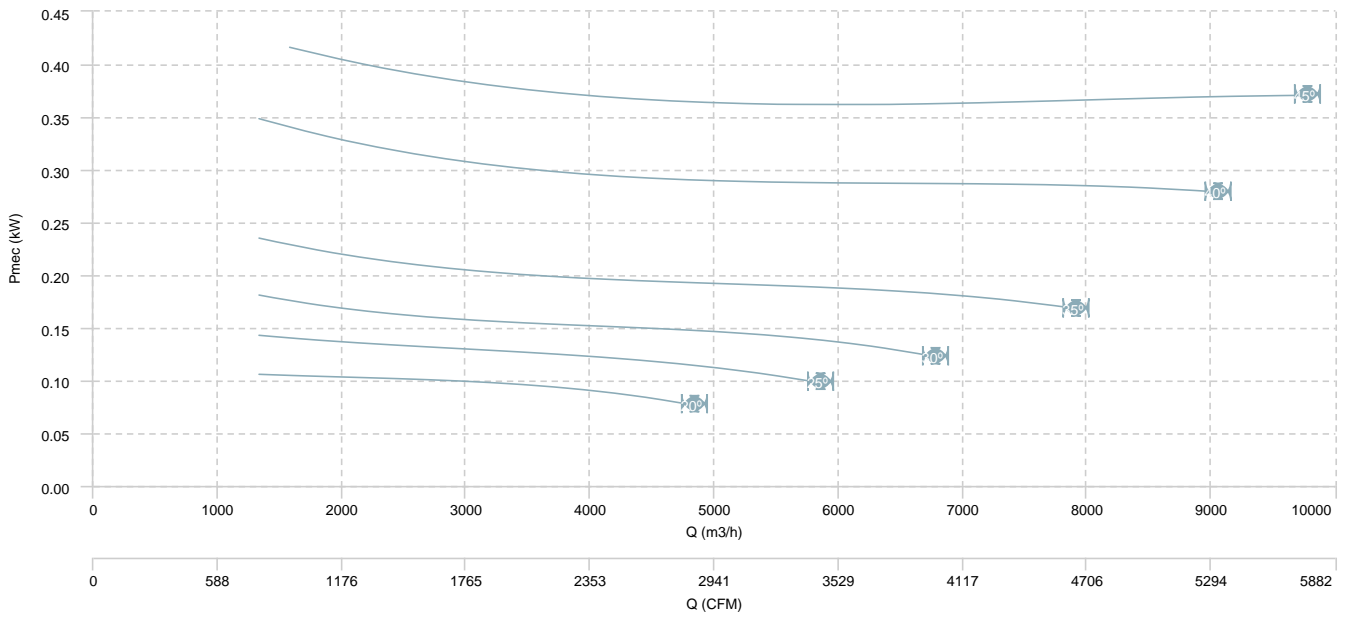

HB 63 M4 (A2:6)

AIR FLOW - PRESSURE

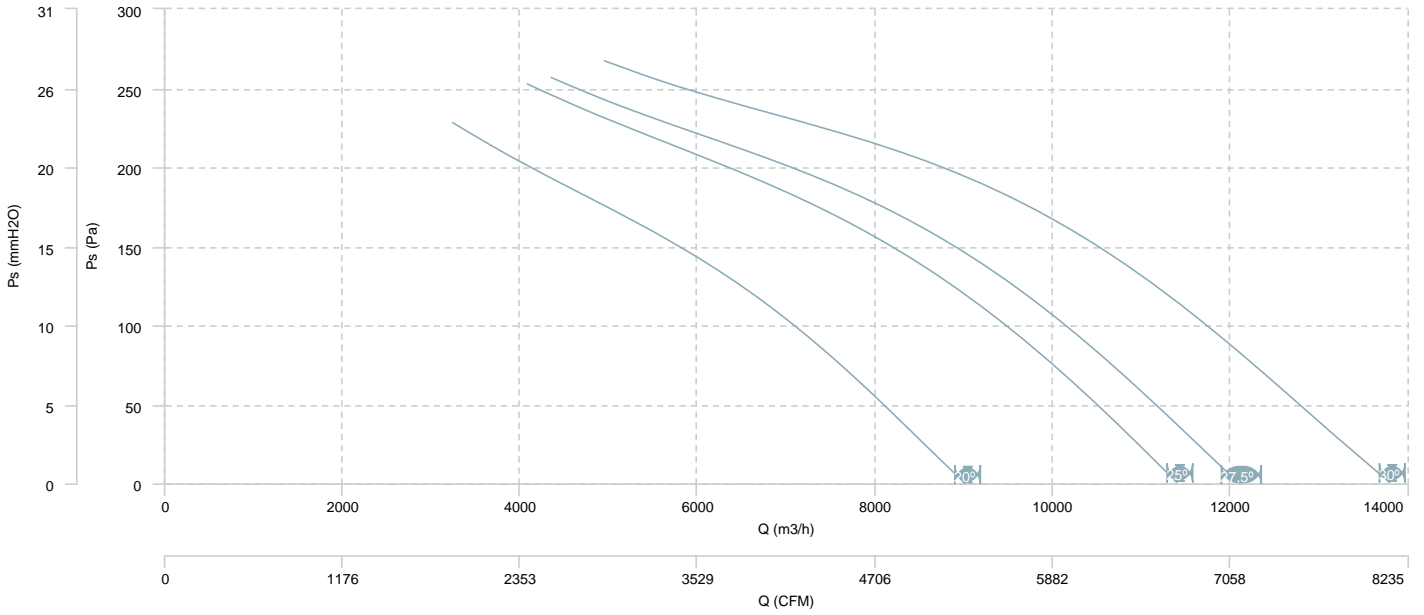

AIR FLOW - MECHANICAL POWER

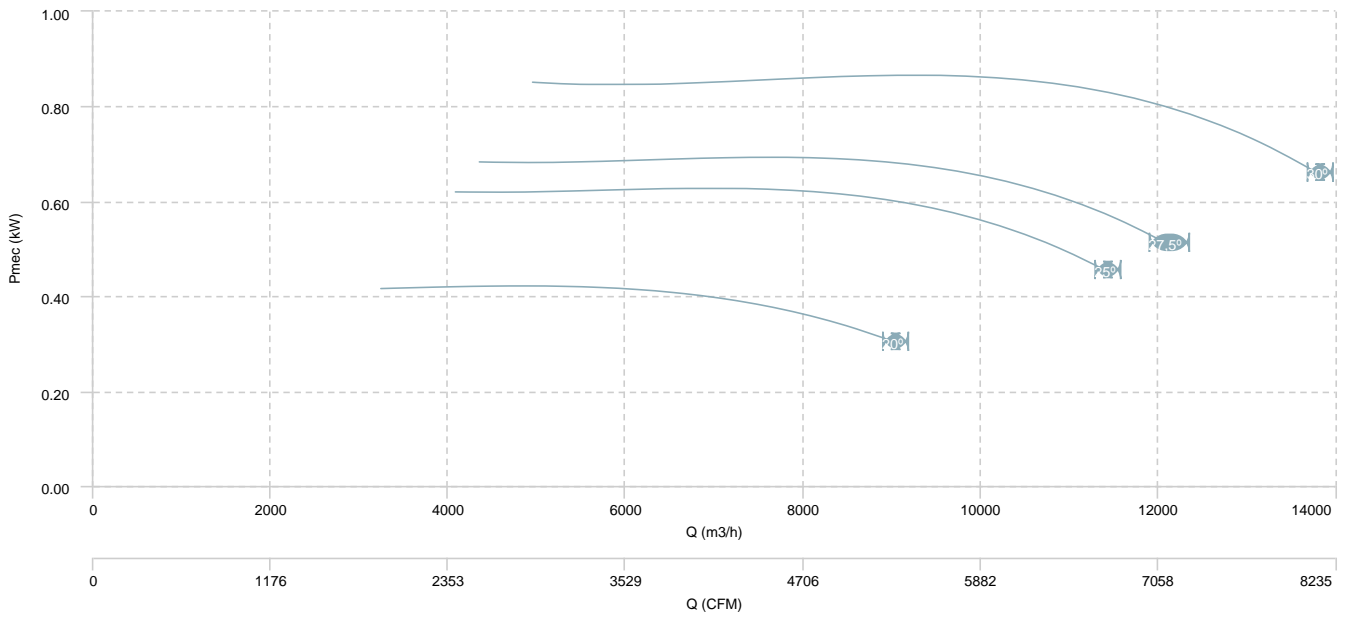

HB 63 M4 (A2:9)

AIR FLOW - PRESSURE

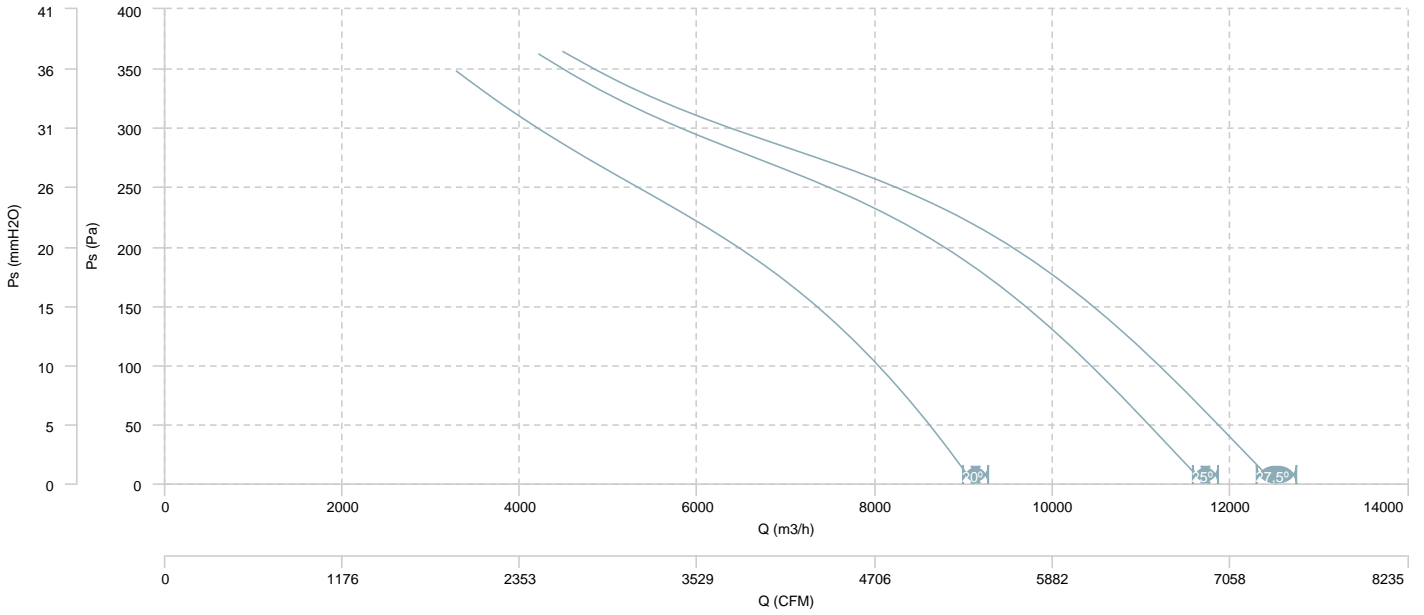

AIR FLOW - MECHANICAL POWER

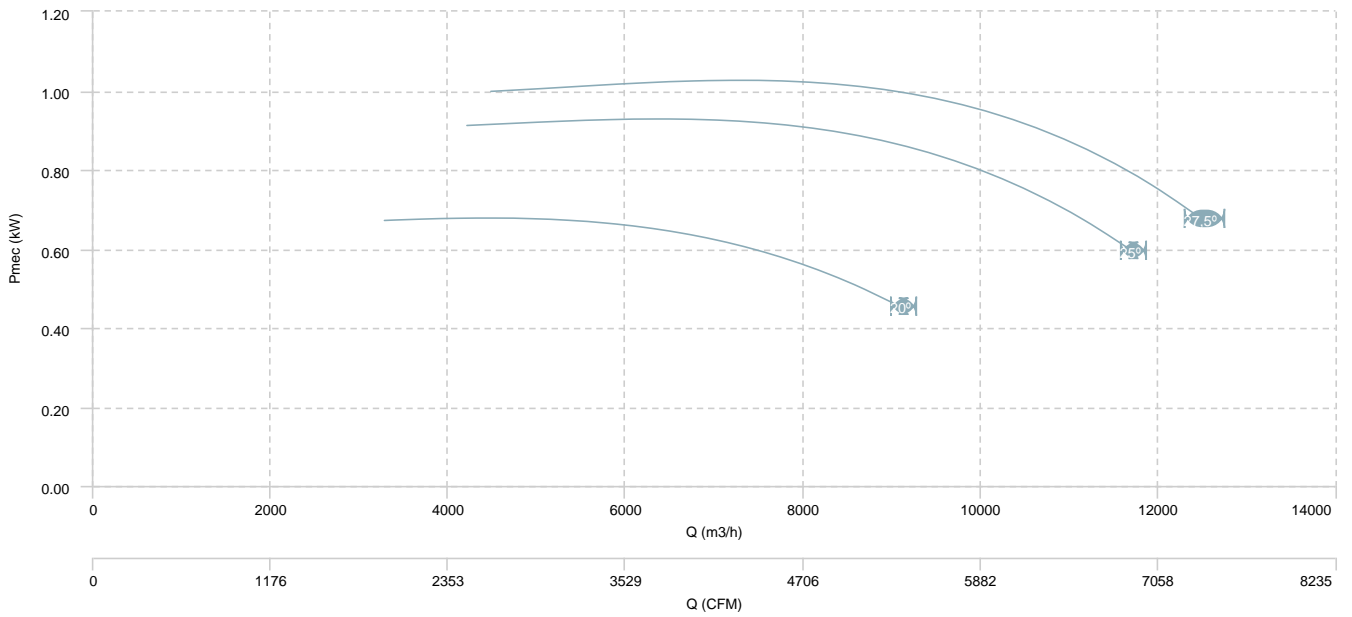

HB 63 M4 (A5:6)

AIR FLOW - PRESSURE

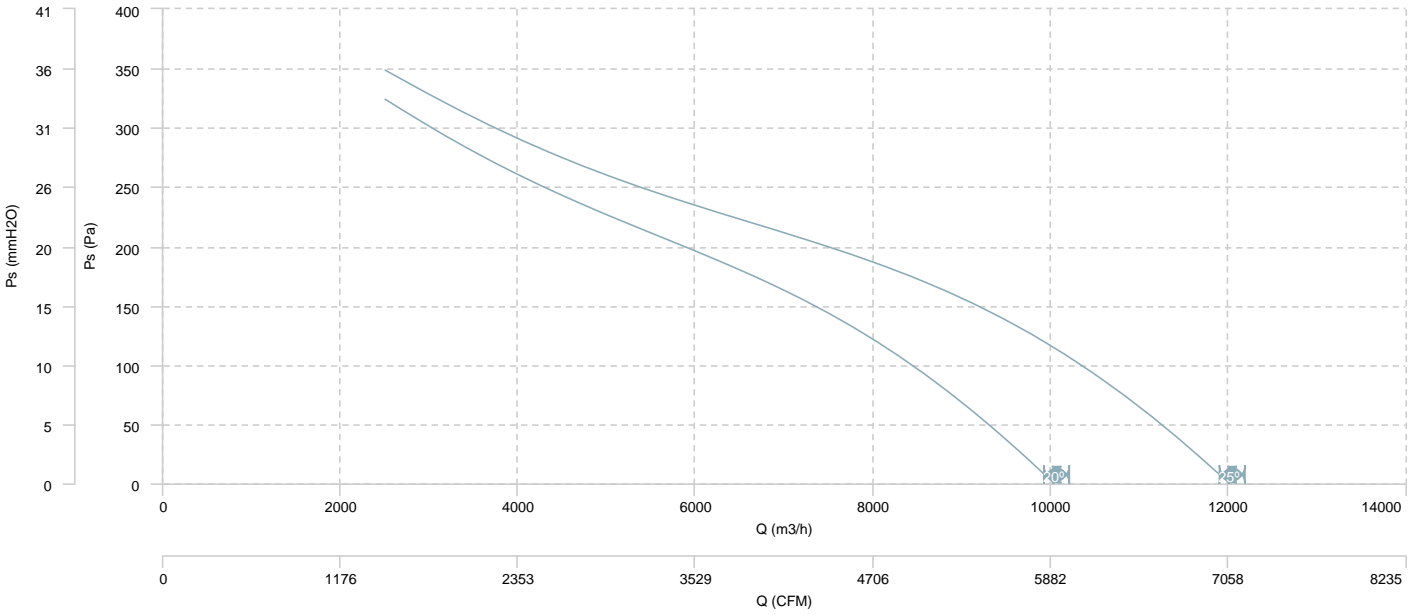

AIR FLOW - MECHANICAL POWER

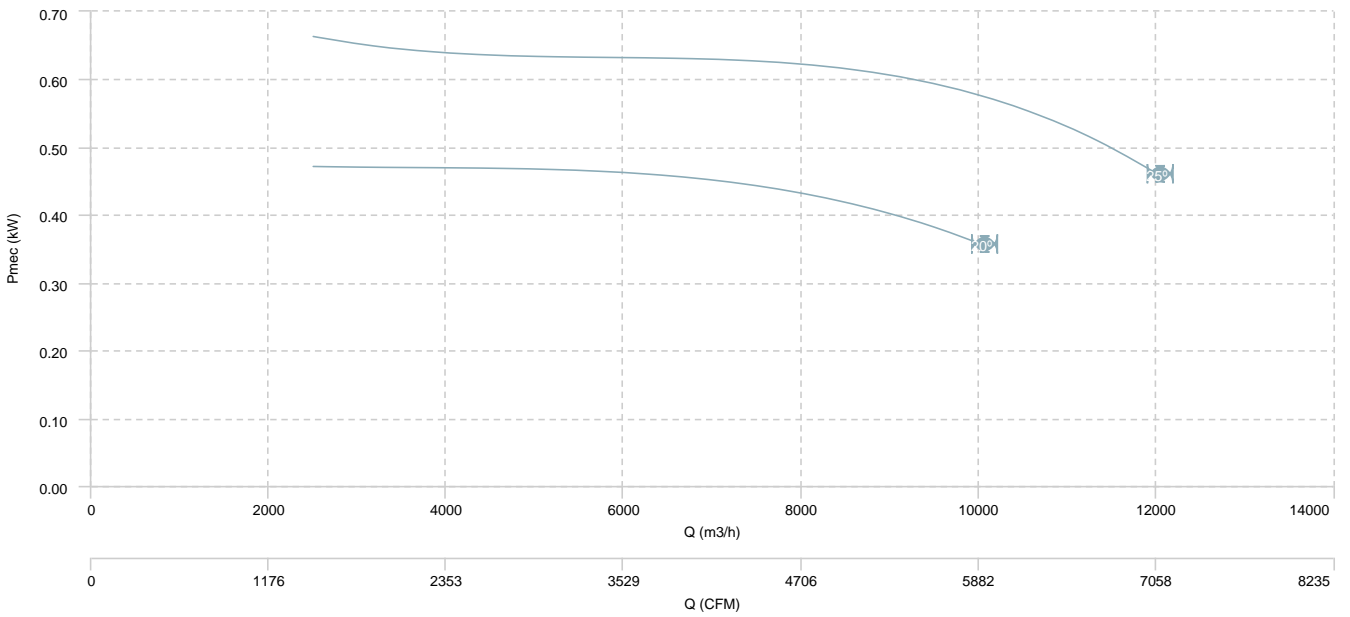

HB 63 M6 (A2:6)

AIR FLOW - PRESSURE

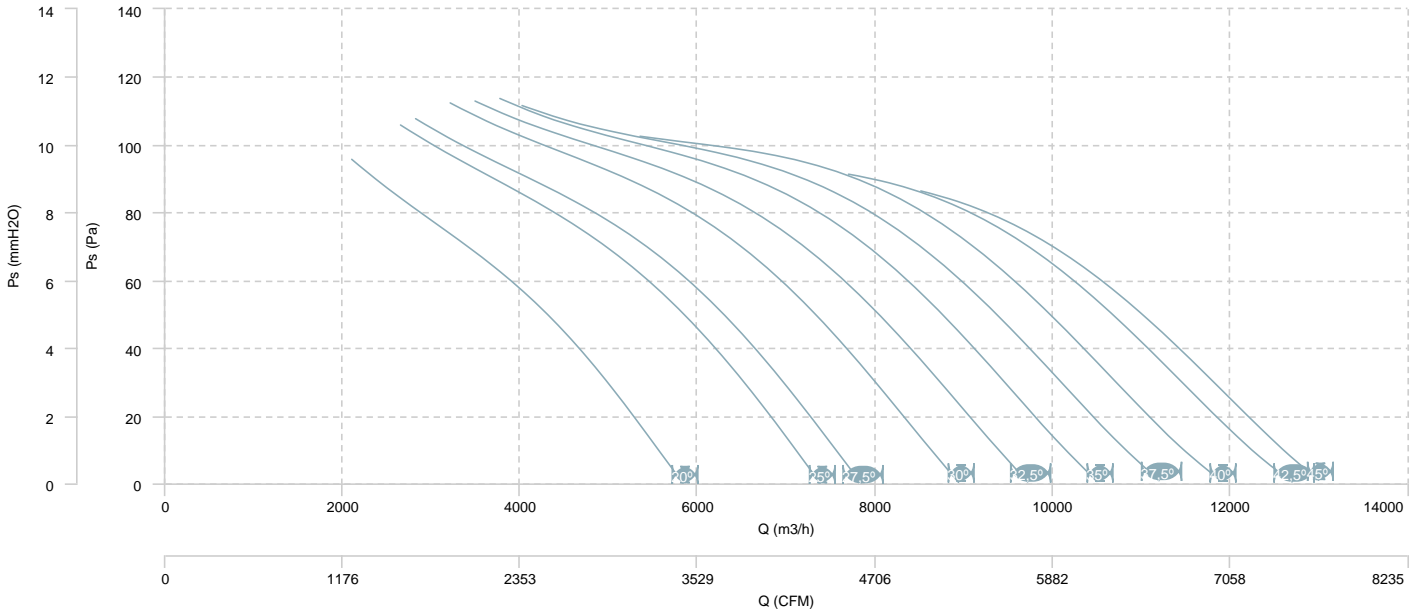

AIR FLOW - MECHANICAL POWER

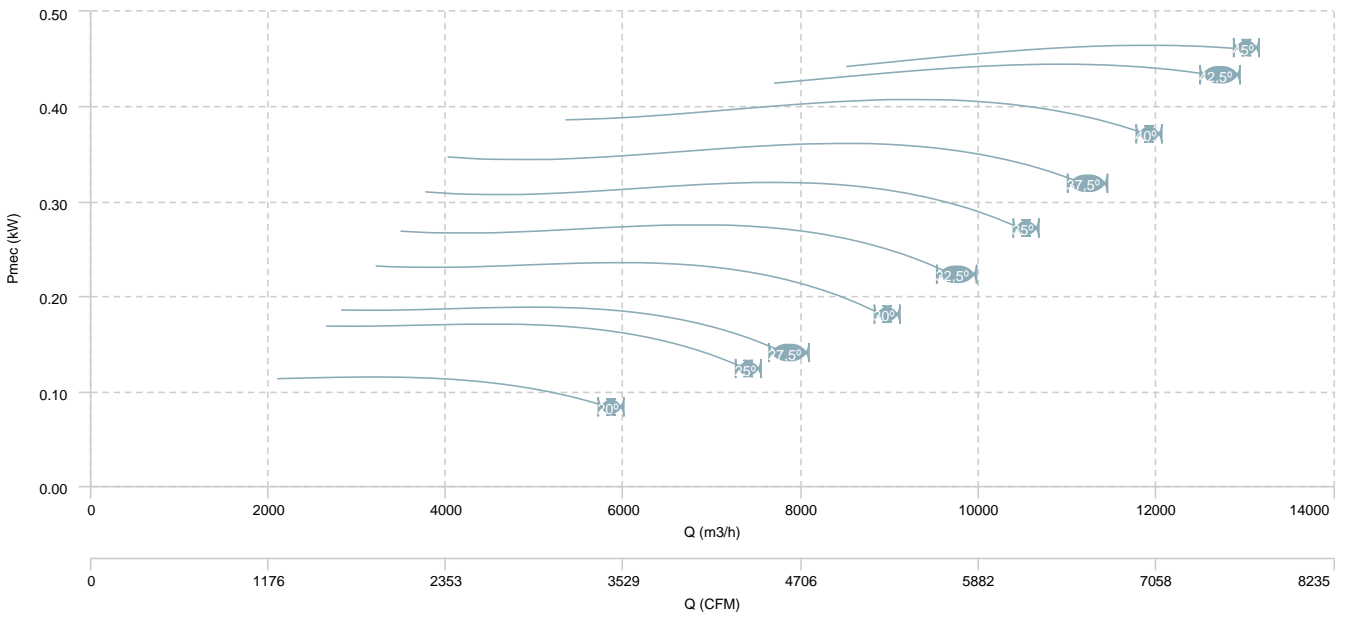

HB 63 M6 (A2:9)

AIR FLOW - PRESSURE

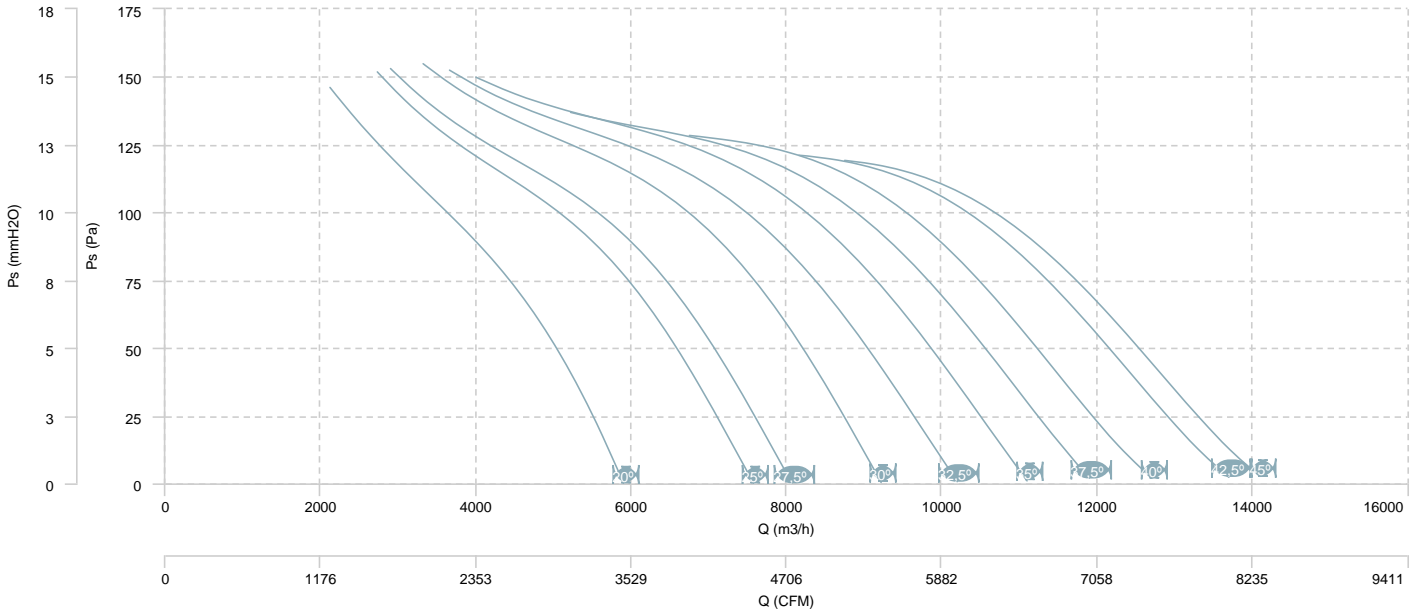

AIR FLOW - MECHANICAL POWER

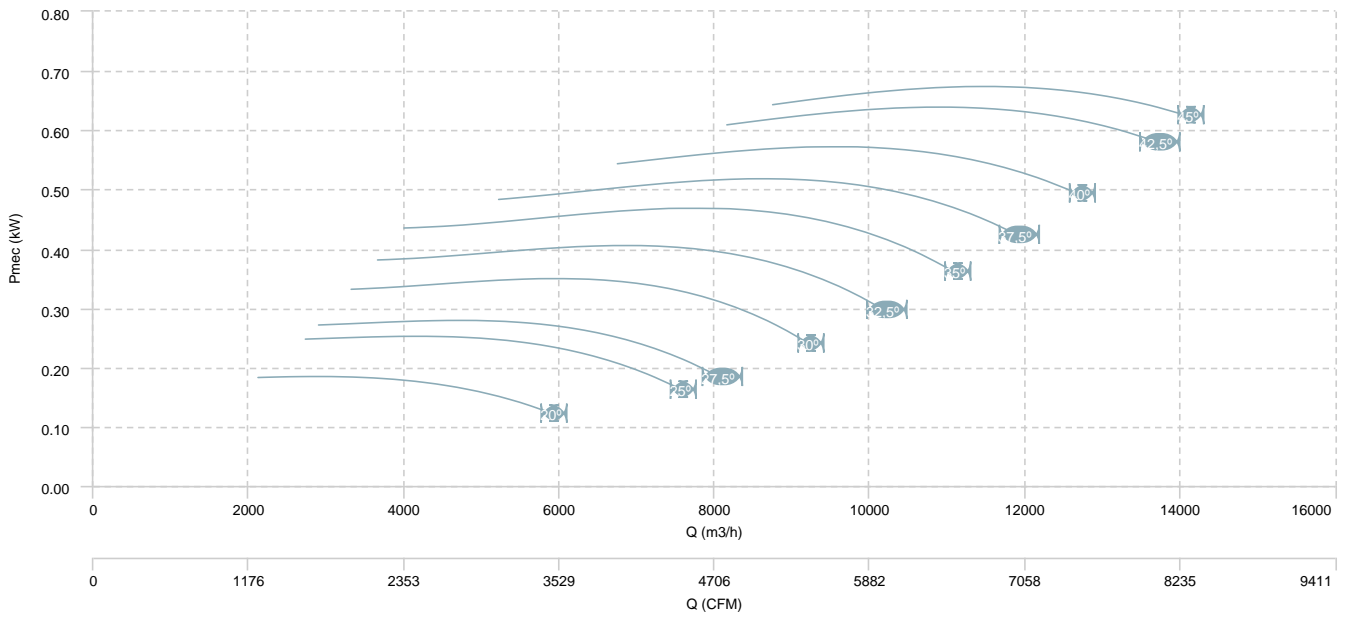

HB 63 M6 (A5:6)

AIR FLOW - PRESSURE

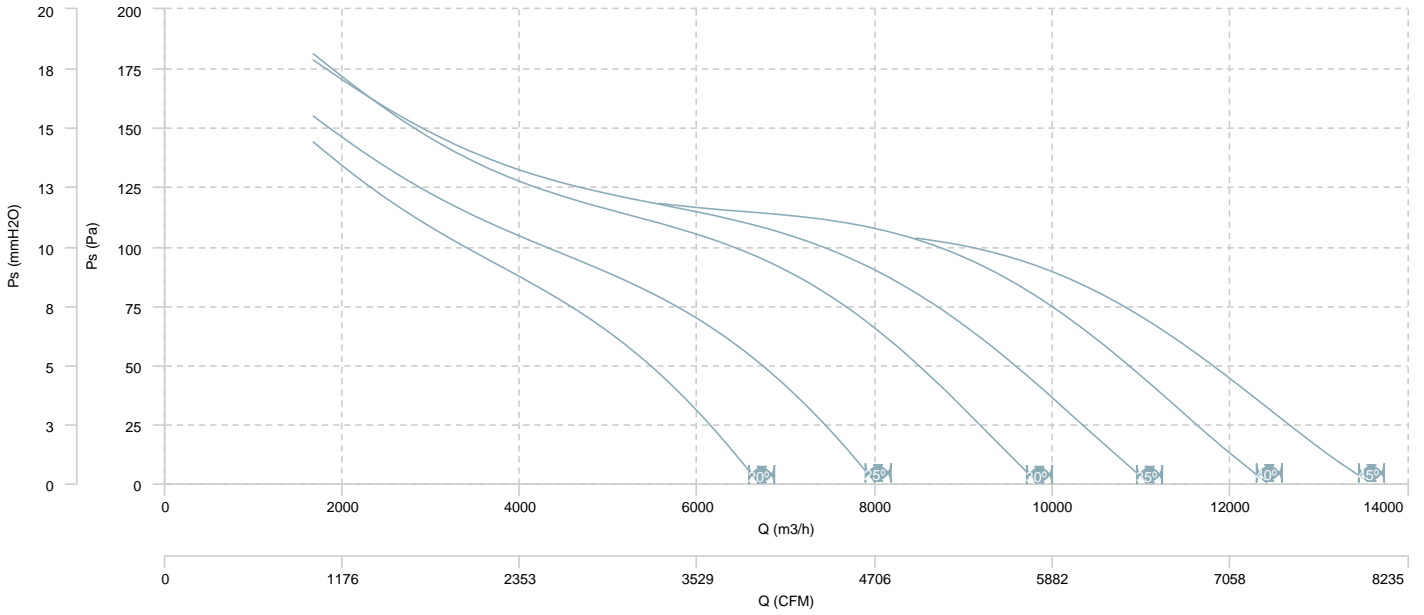

AIR FLOW - MECHANICAL POWER

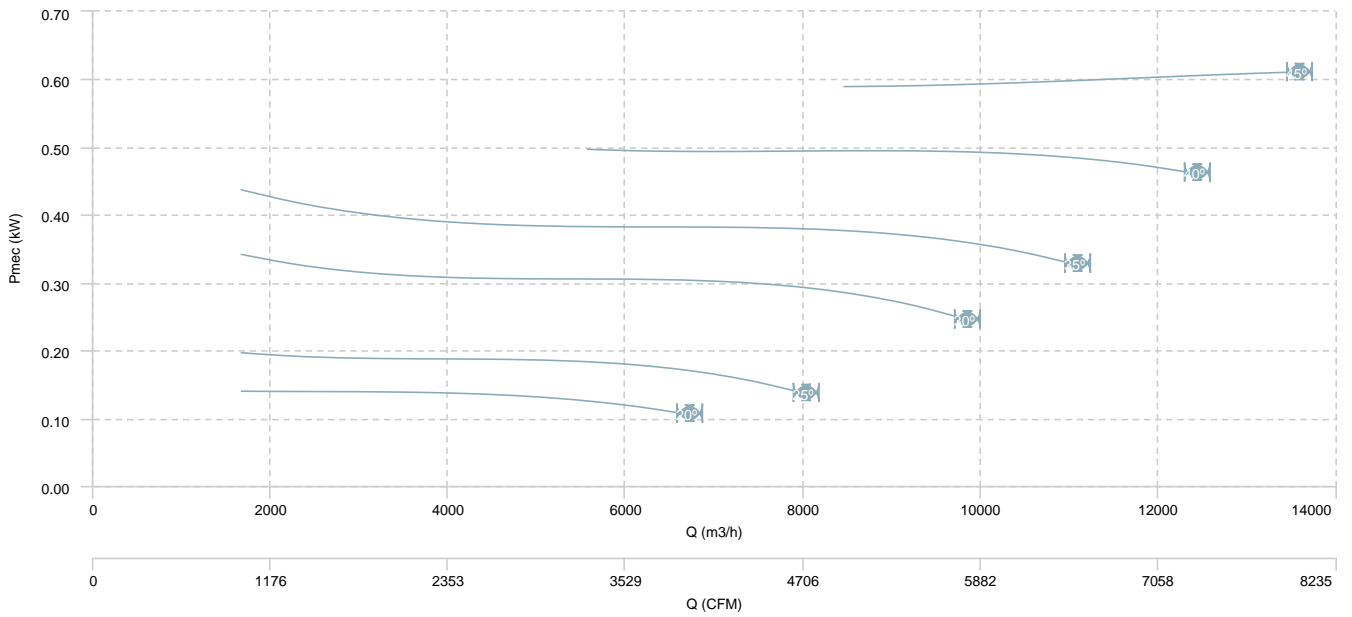

HB 71 M4 (A5:6)

AIR FLOW - PRESSURE

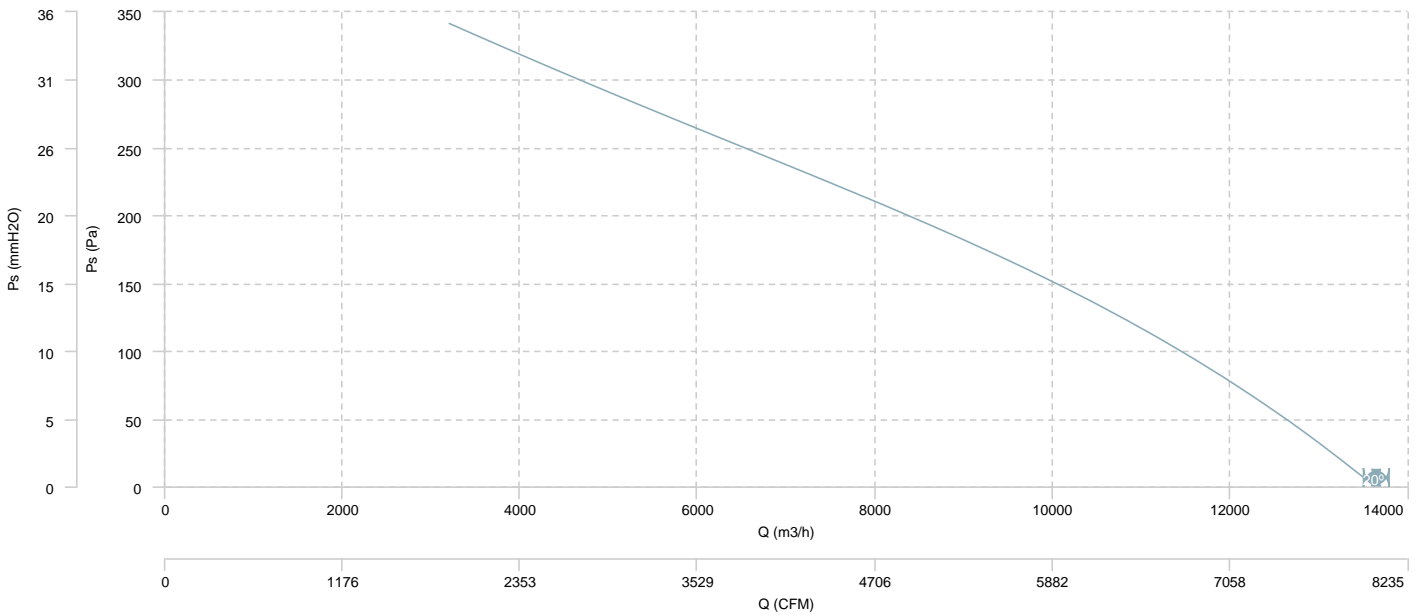

AIR FLOW - MECHANICAL POWER

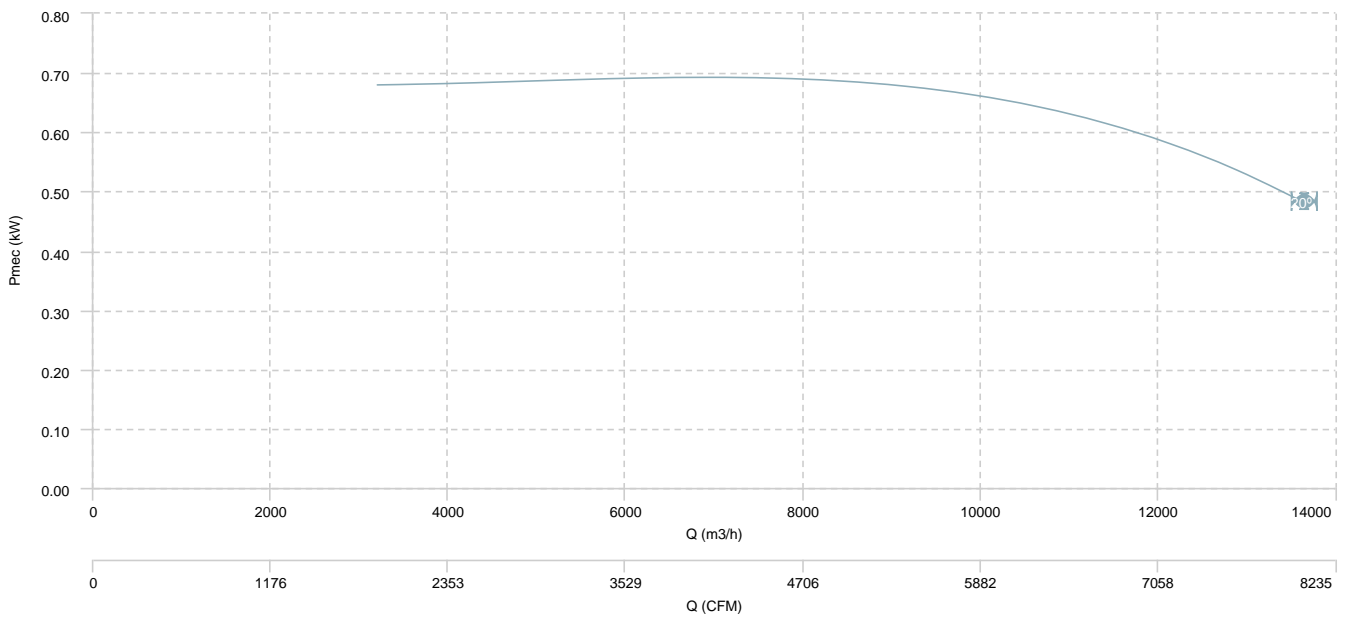

HB 71 M4 (A2:9)

AIR FLOW - PRESSURE

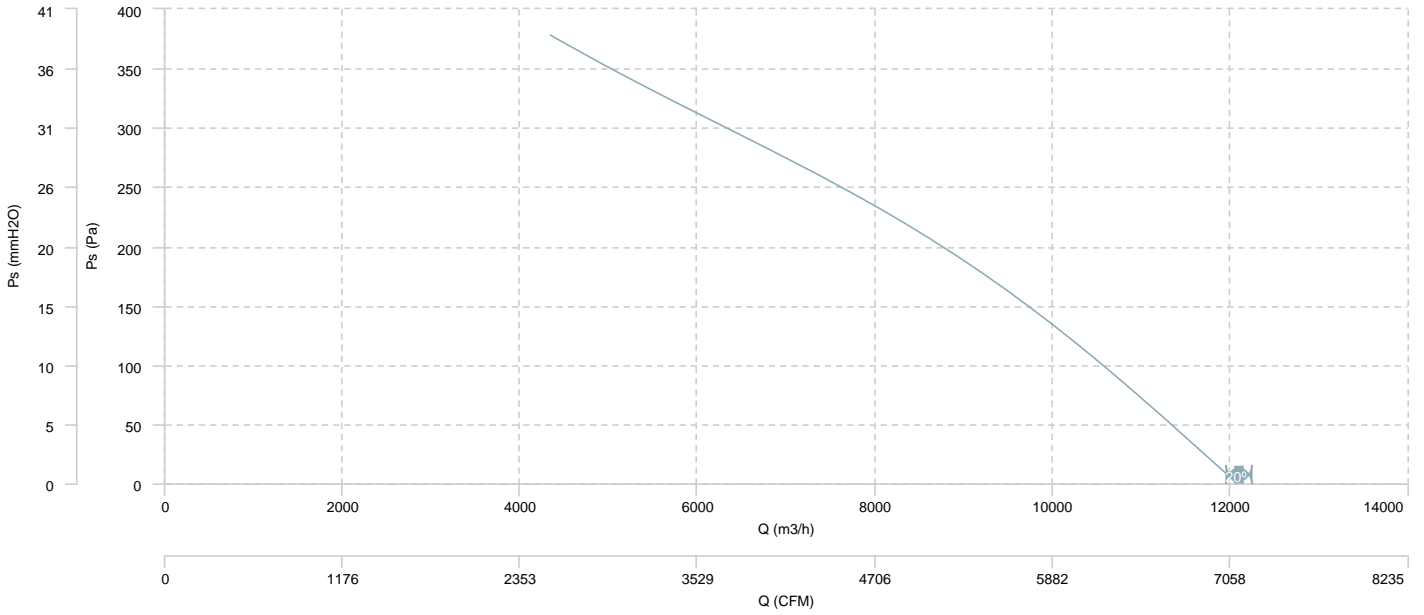

AIR FLOW - MECHANICAL POWER

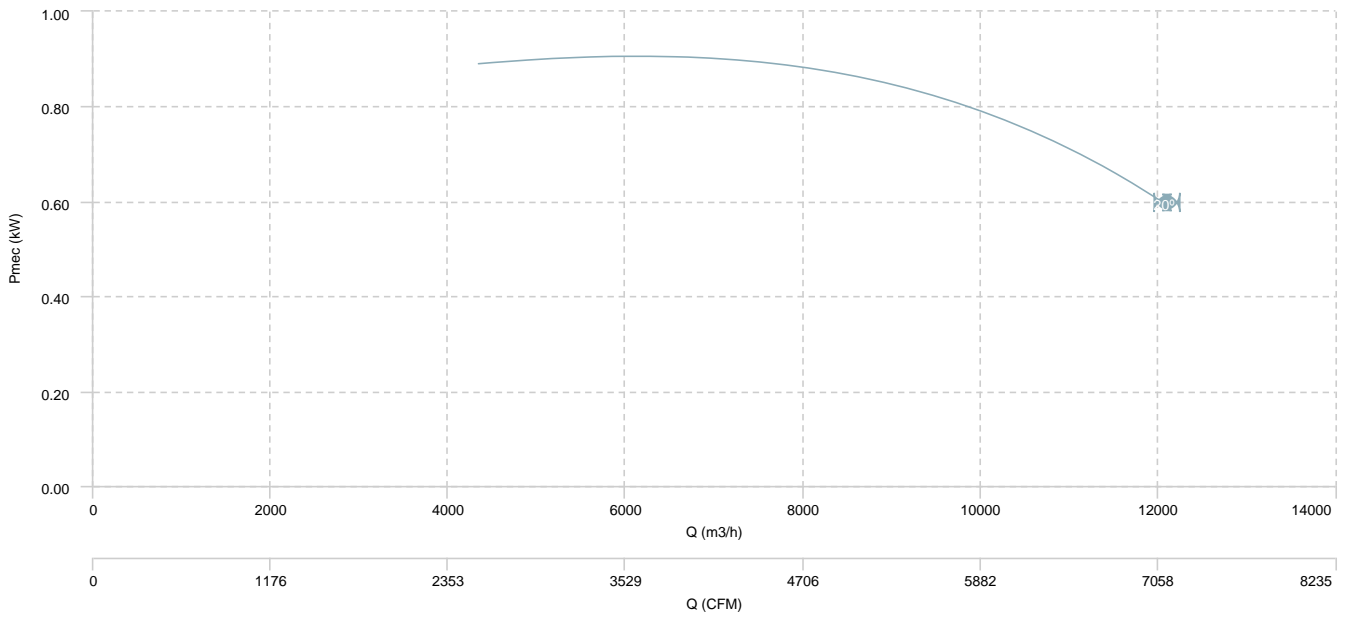

HB 71 M4 (A2:6)

AIR FLOW - PRESSURE

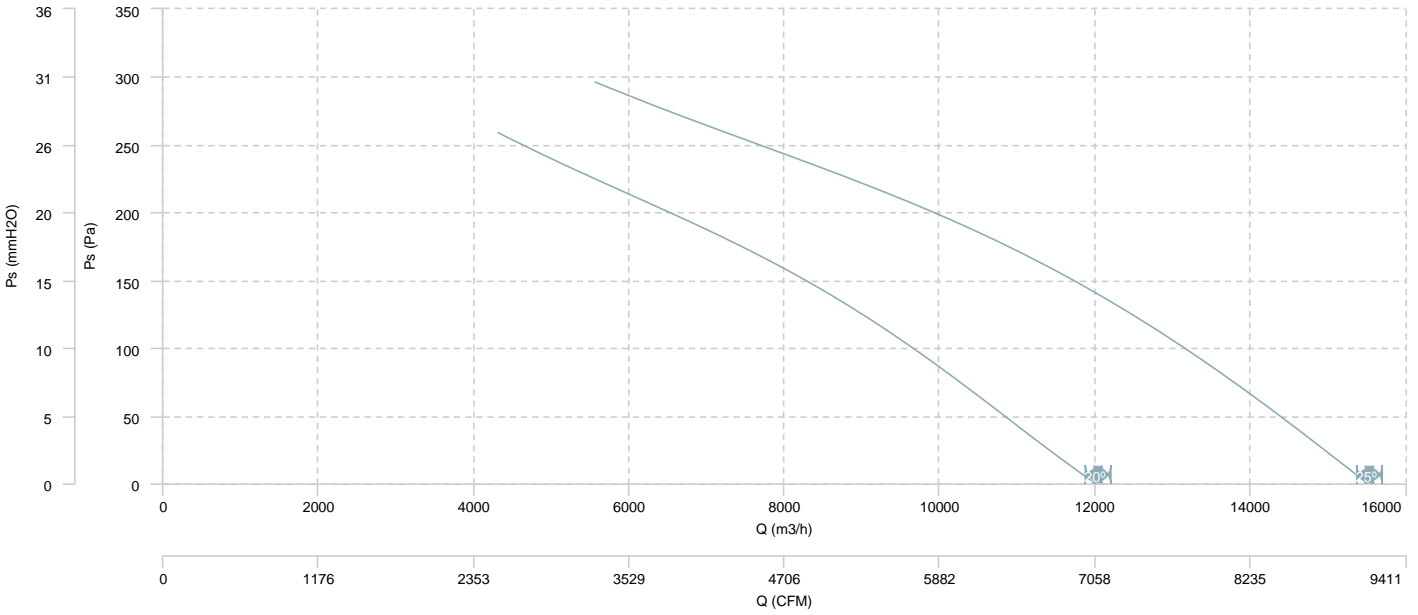

AIR FLOW - MECHANICAL POWER

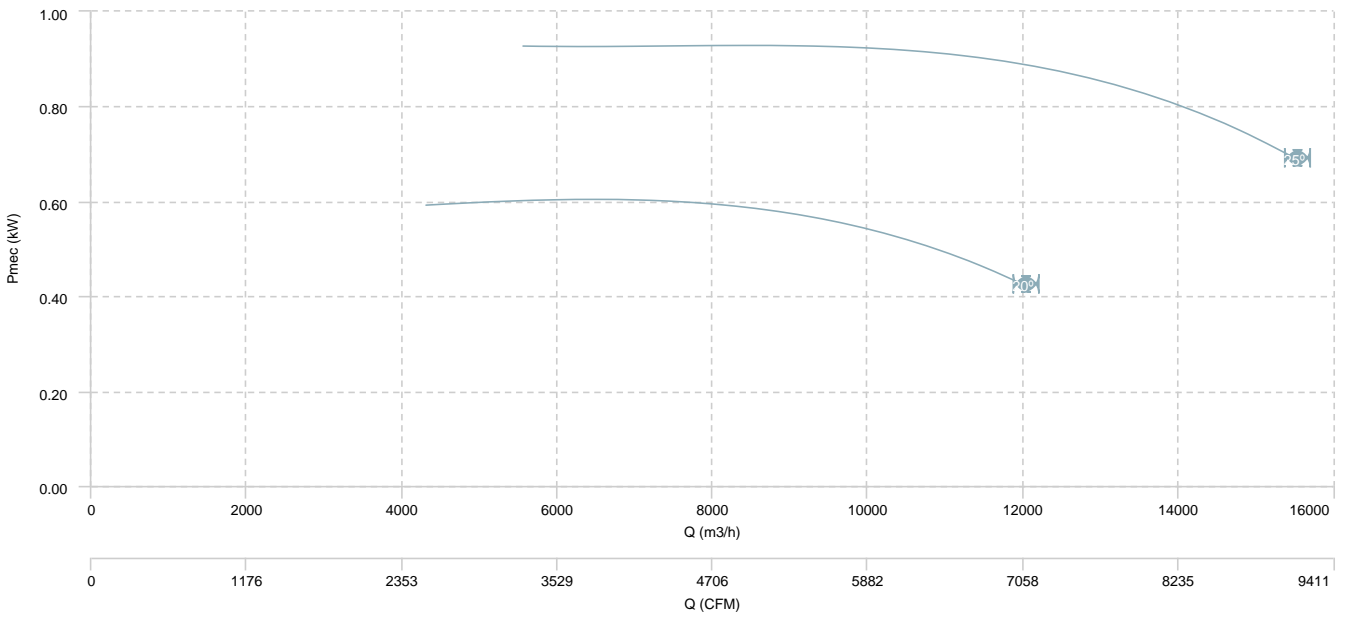

HB 71 M6 (A2:6)

AIR FLOW - PRESSURE

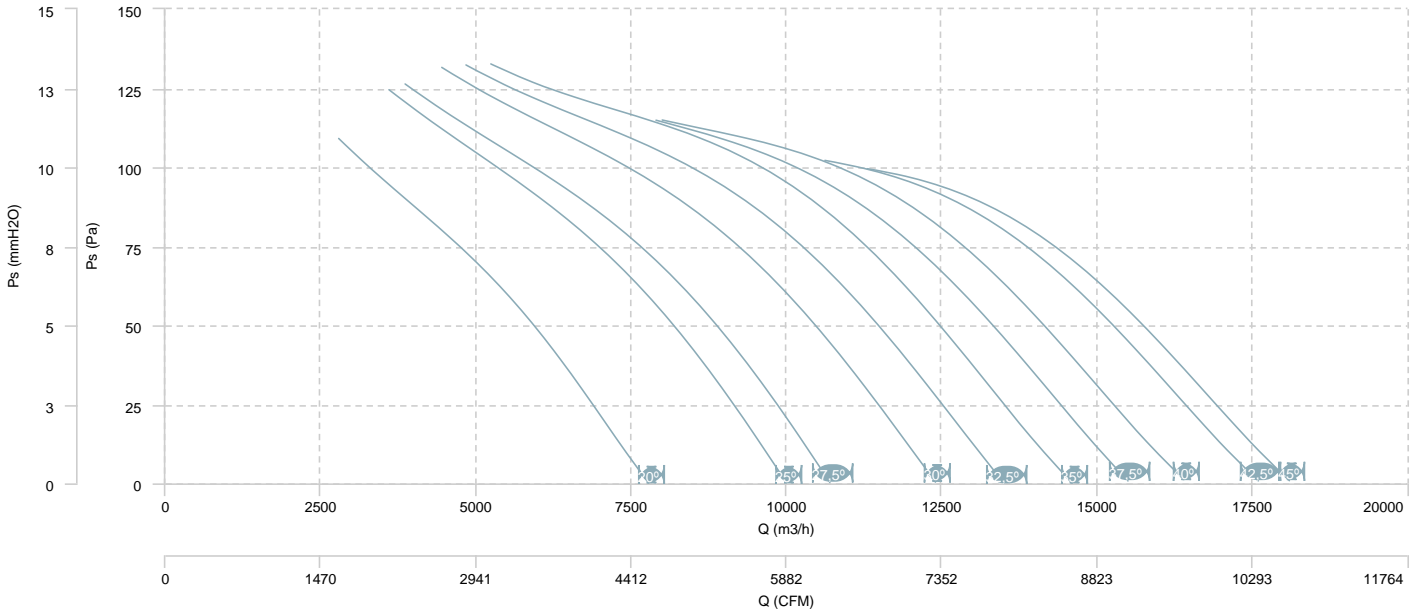

AIR FLOW - MECHANICAL POWER

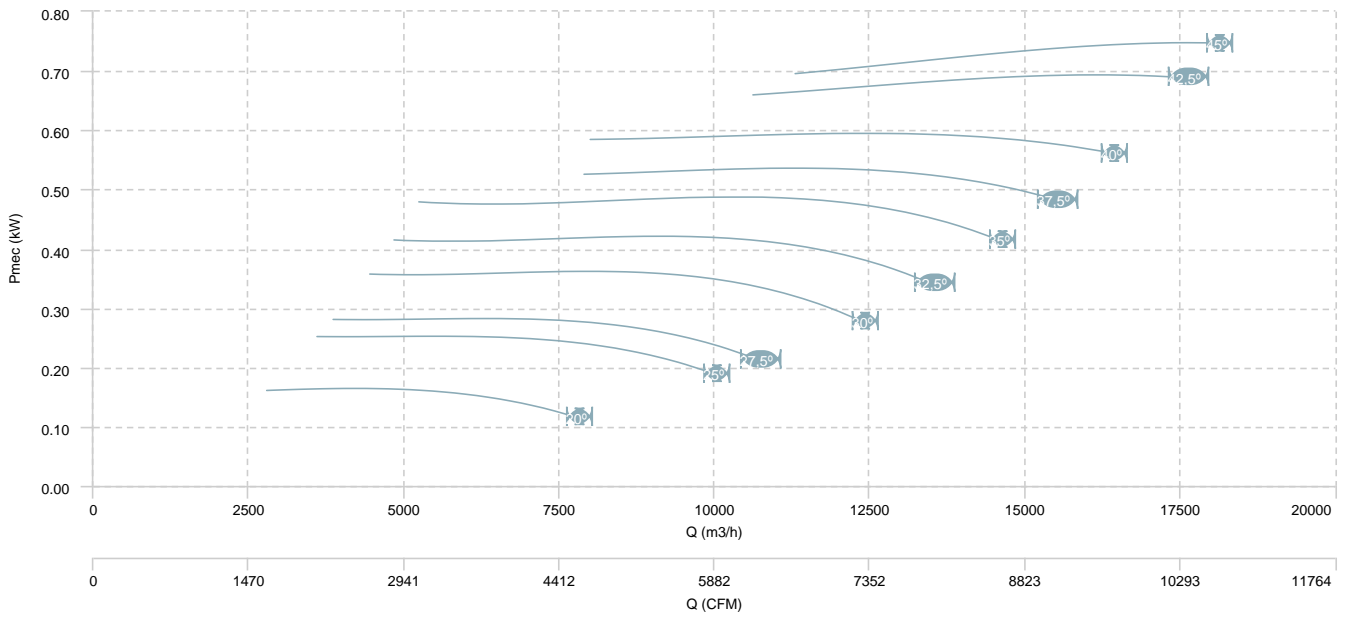

HB 71 M6 (A2:9)

AIR FLOW - PRESSURE

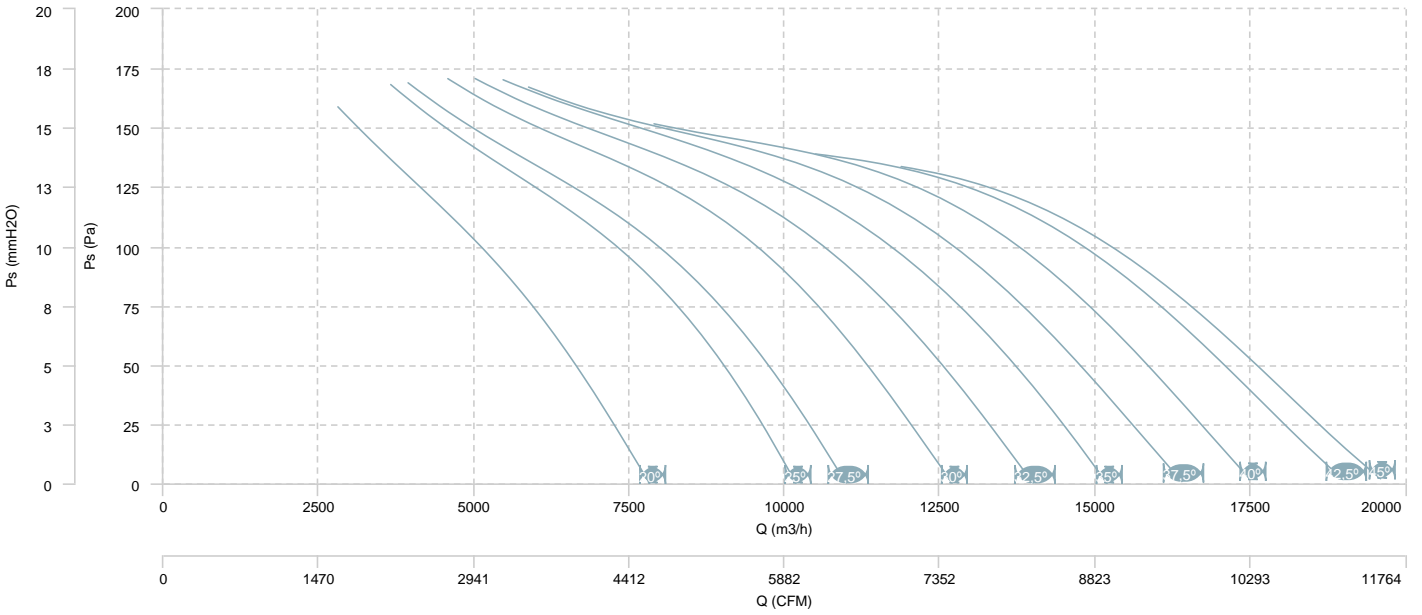

AIR FLOW - MECHANICAL POWER

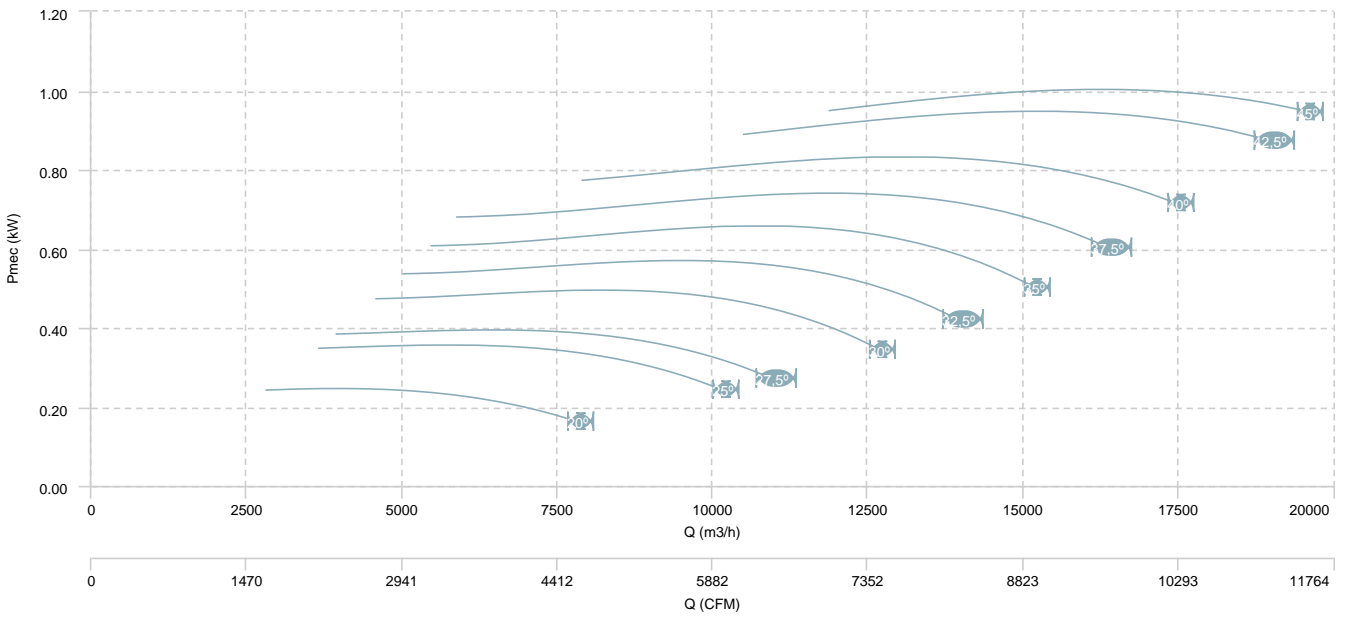

HB 71 M6 (A5:6)

AIR FLOW - PRESSURE

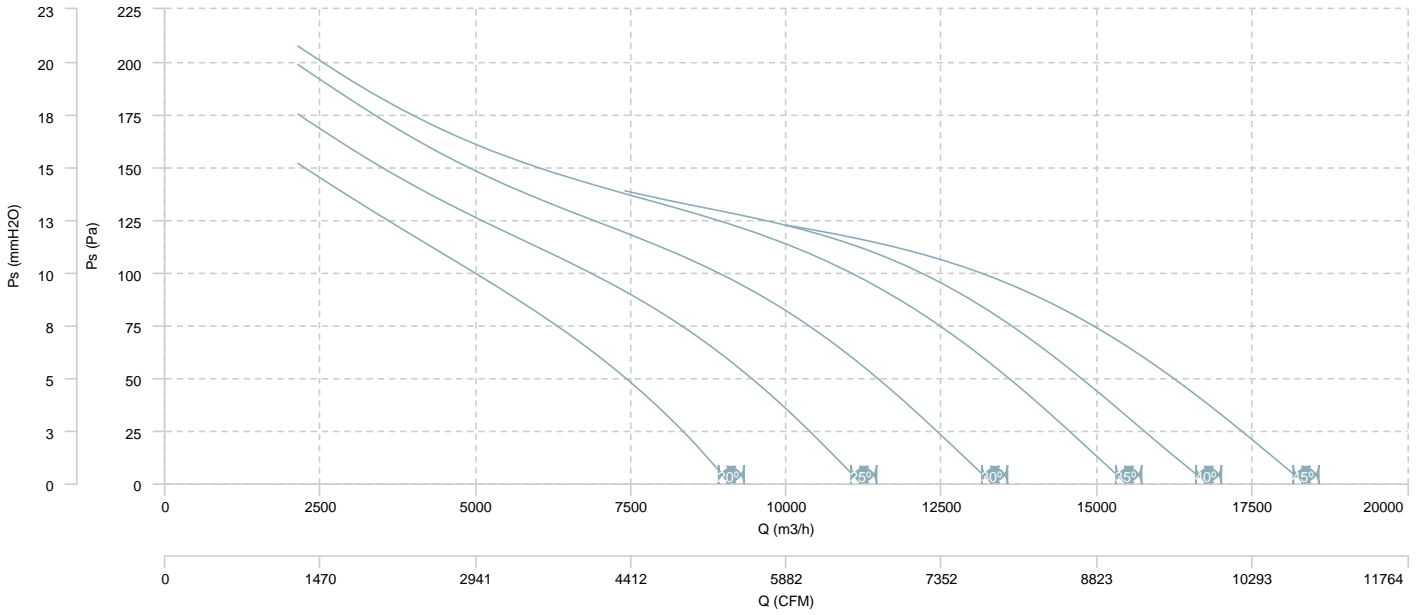

AIR FLOW - MECHANICAL POWER

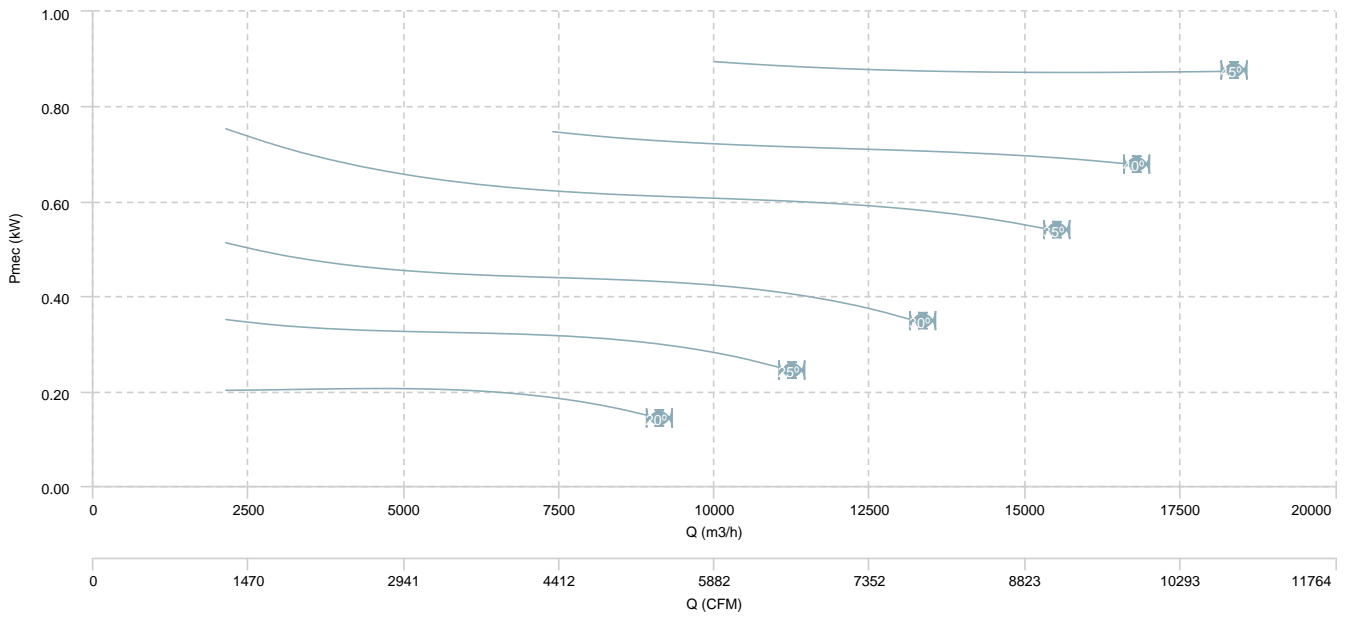

HB 35 T4 (A0:6)

AIR FLOW - PRESSURE

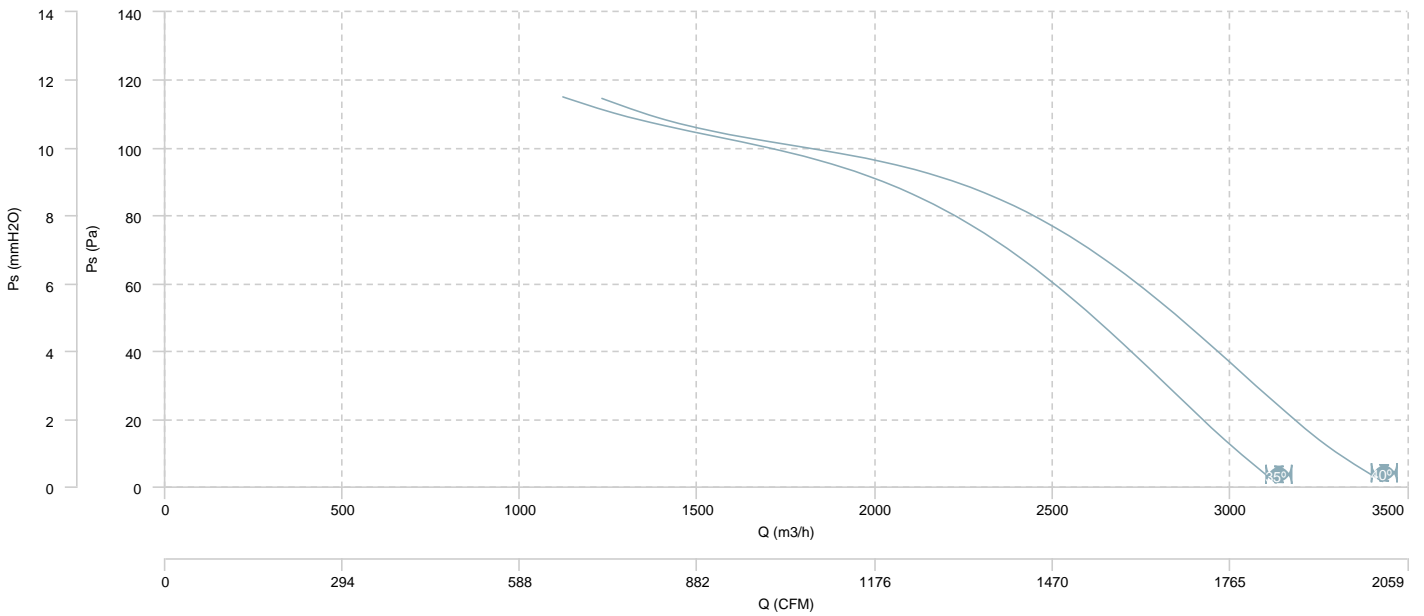

AIR FLOW - MECHANICAL POWER

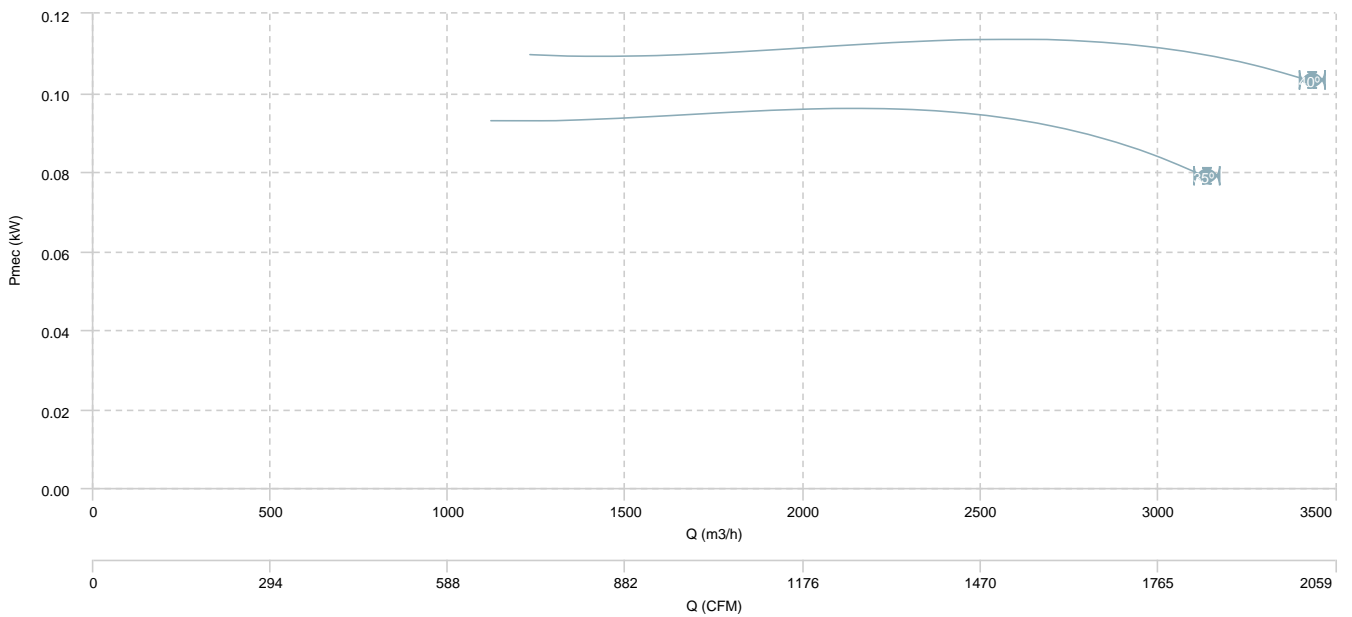

HB 35 T6 (A0:6)

AIR FLOW - PRESSURE

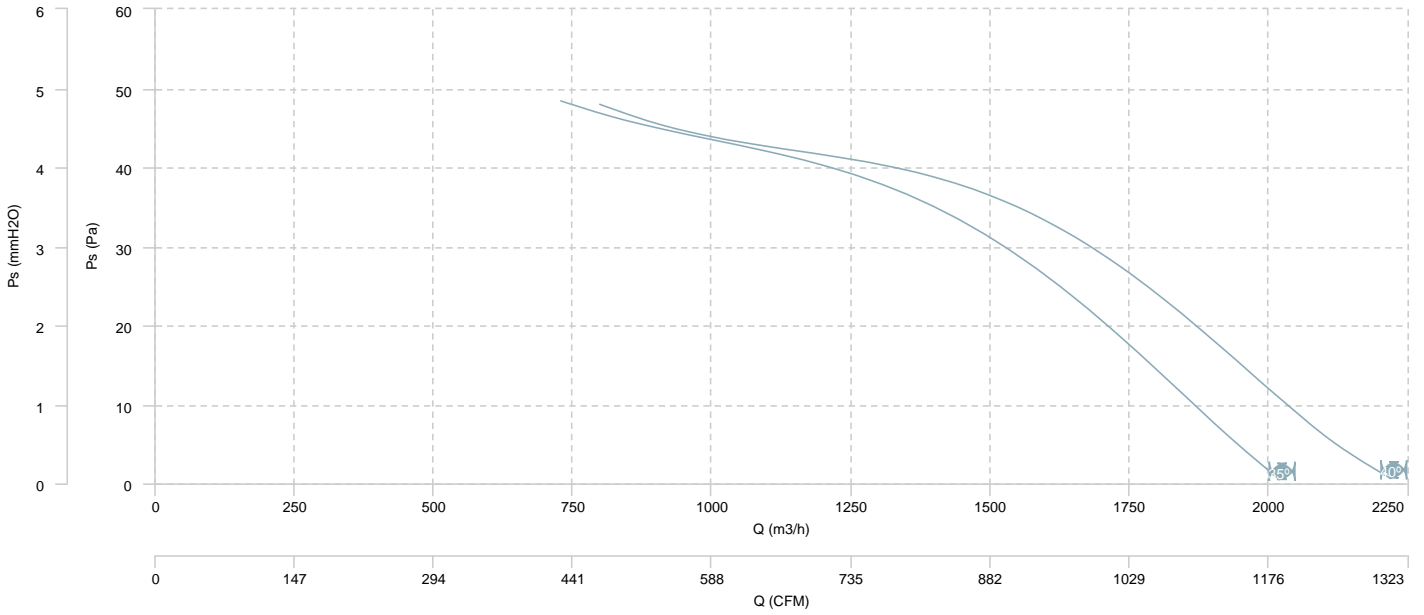

AIR FLOW - MECHANICAL POWER

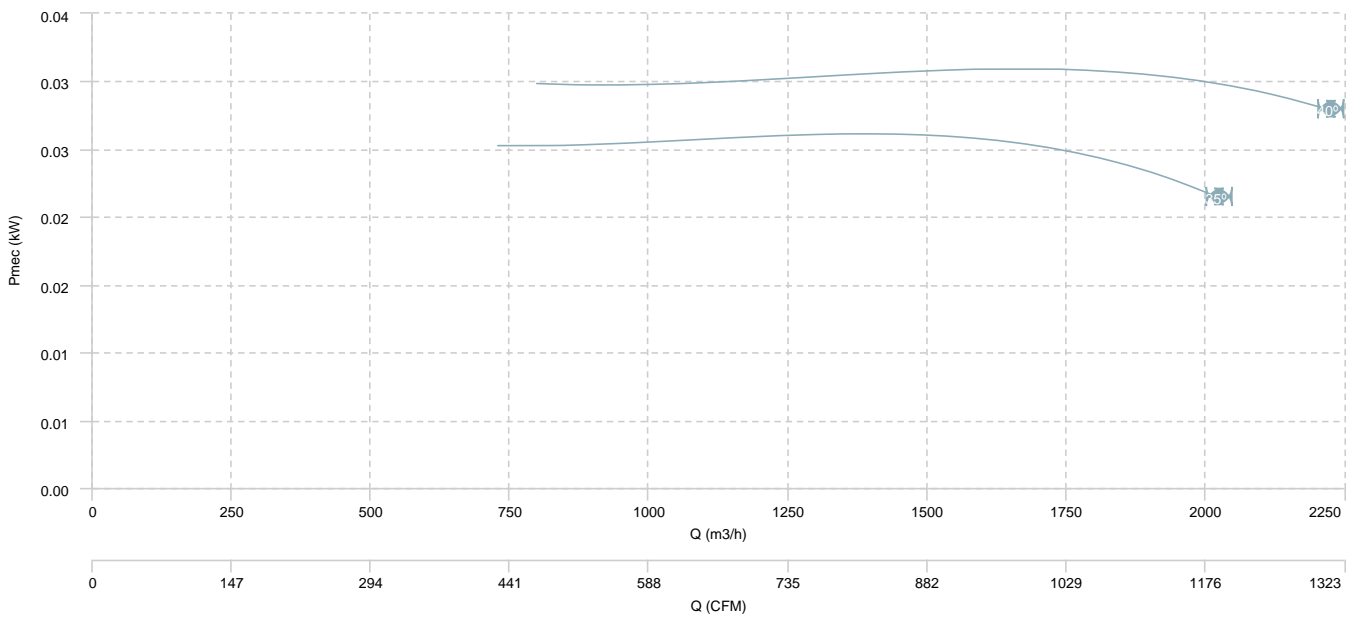

HB 35 T4/T8 (A0:6)

AIR FLOW - PRESSURE (4 poles)

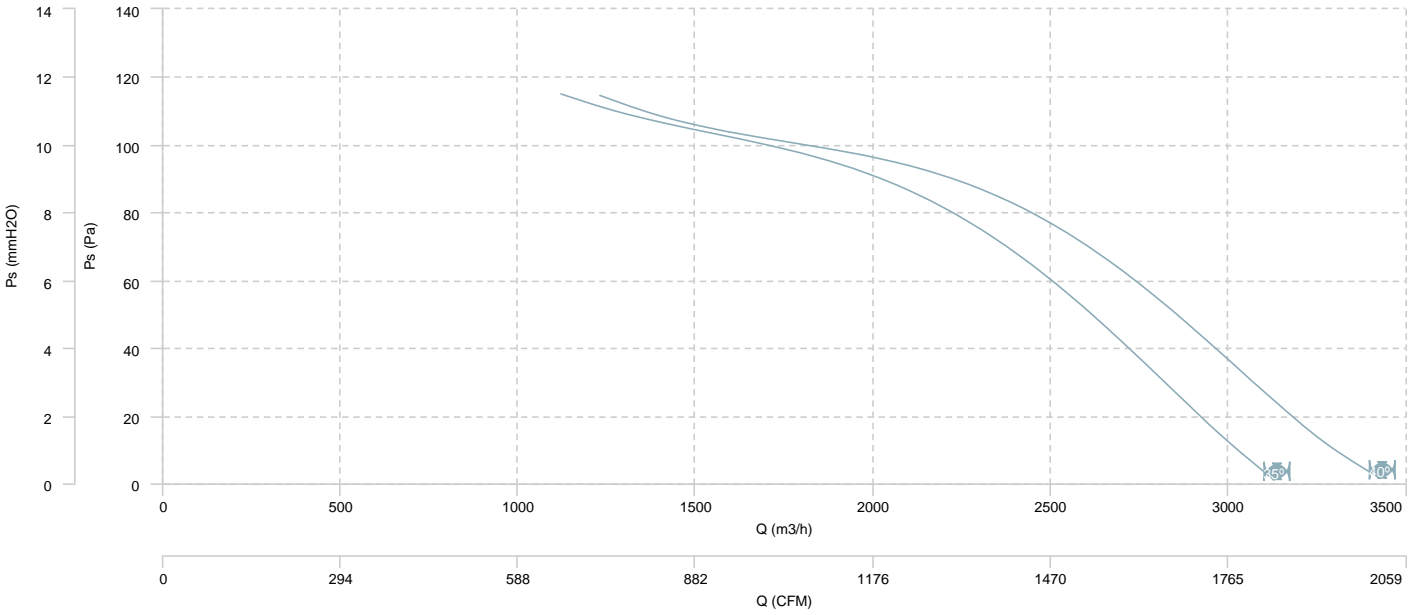

AIR FLOW - MECHANICAL POWER (4 poles)

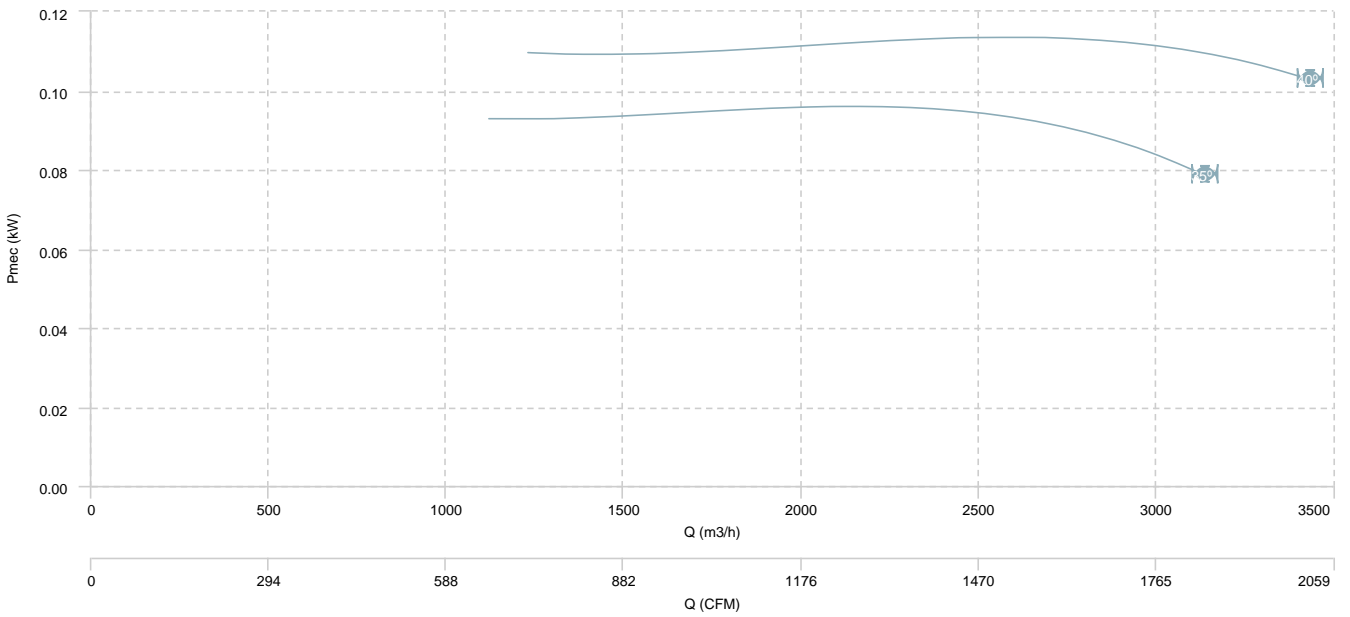

HB 35 T4/T8 (A0:6)

AIR FLOW - PRESSURE (8 poles)

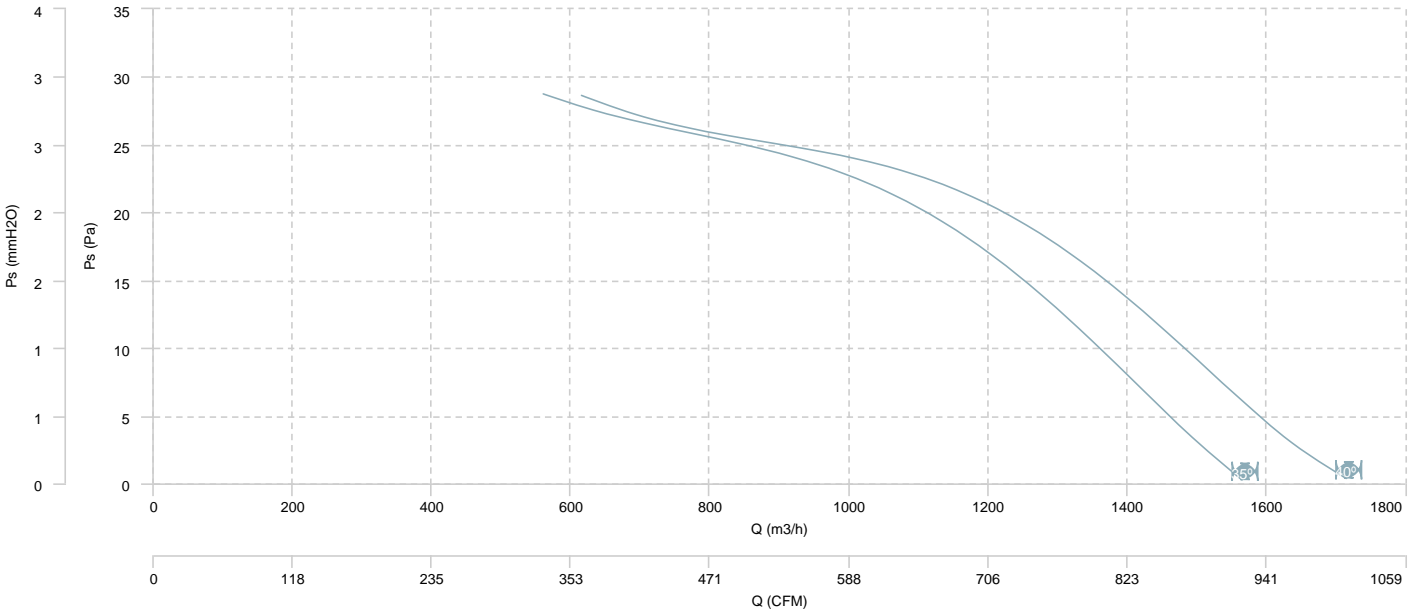

AIR FLOW - MECHANICAL POWER (8 poles)

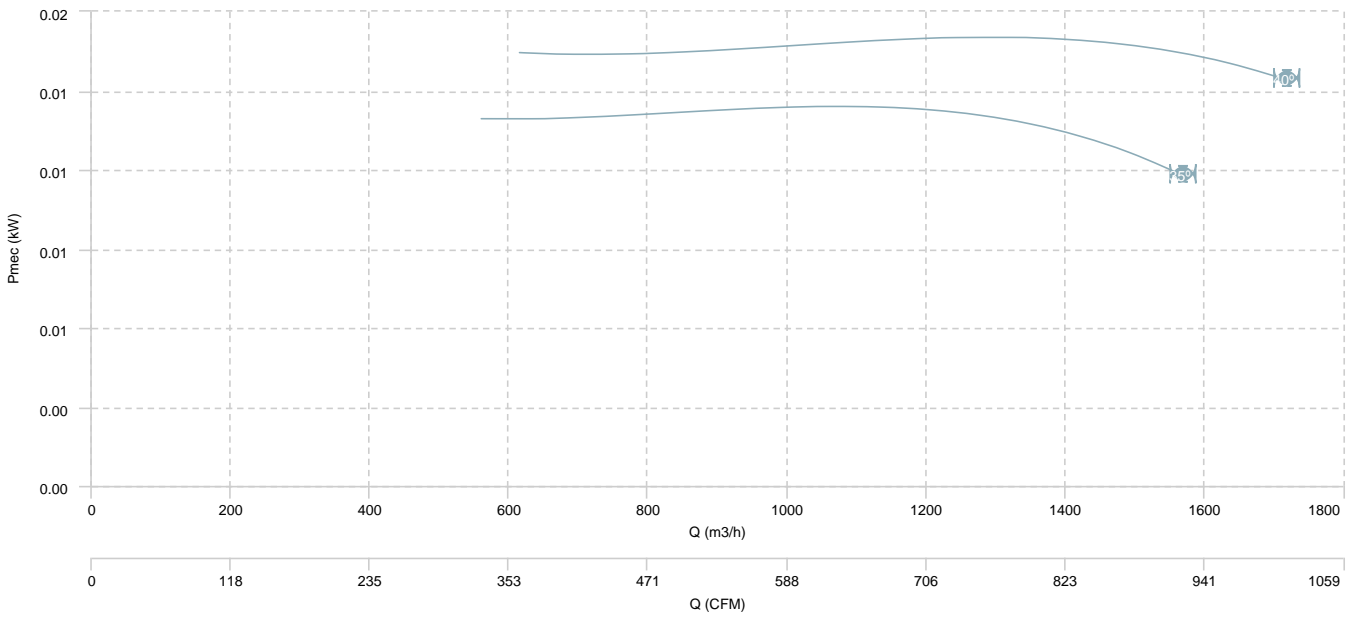

HB 40 T4 (A0:6)

AIR FLOW - PRESSURE

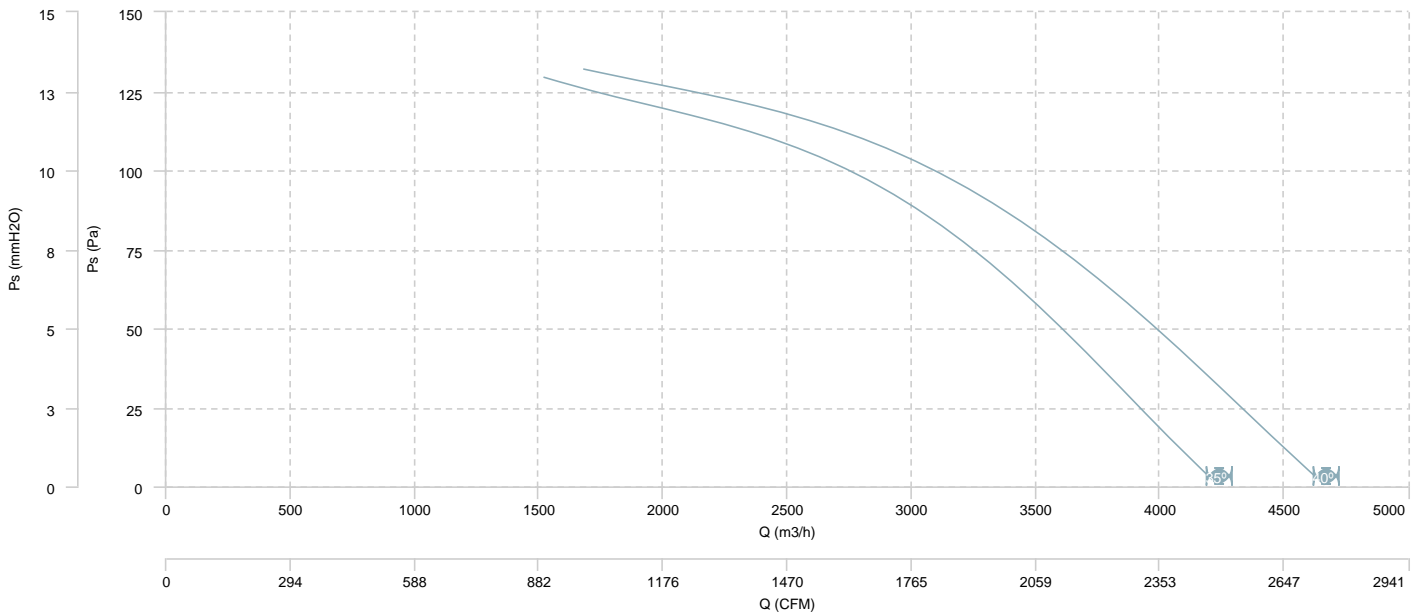

AIR FLOW - MECHANICAL POWER

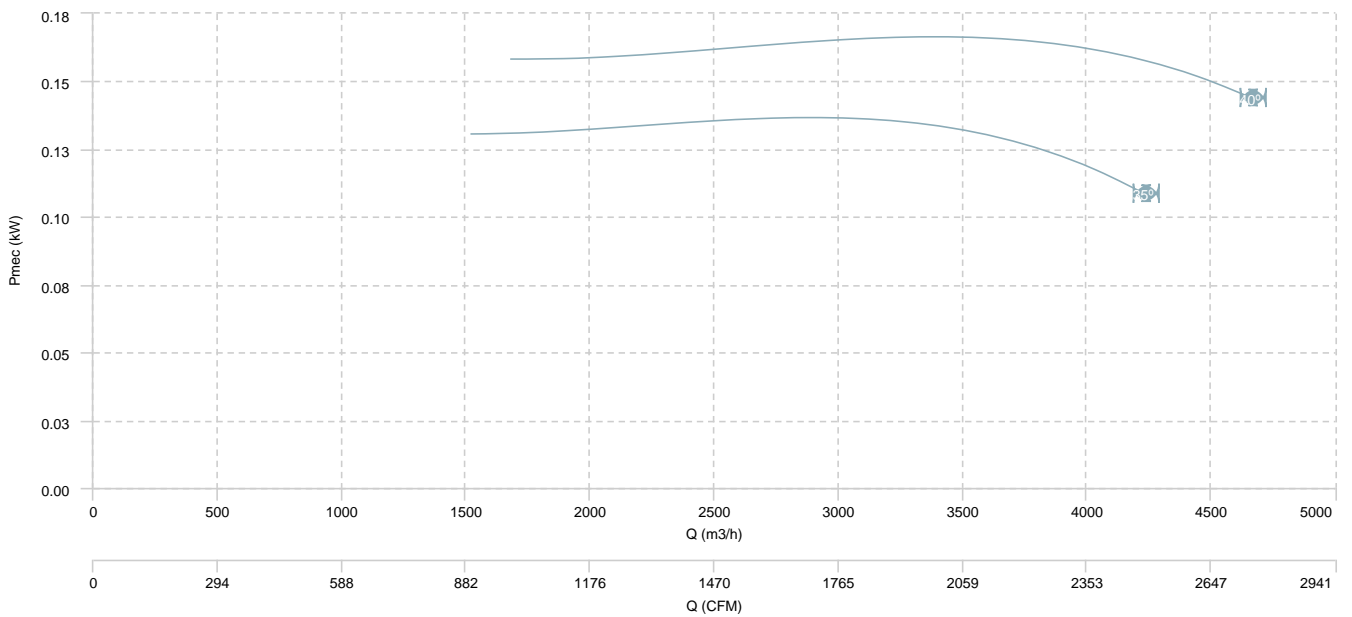

HB 40 T6 (A0:6)

AIR FLOW - PRESSURE

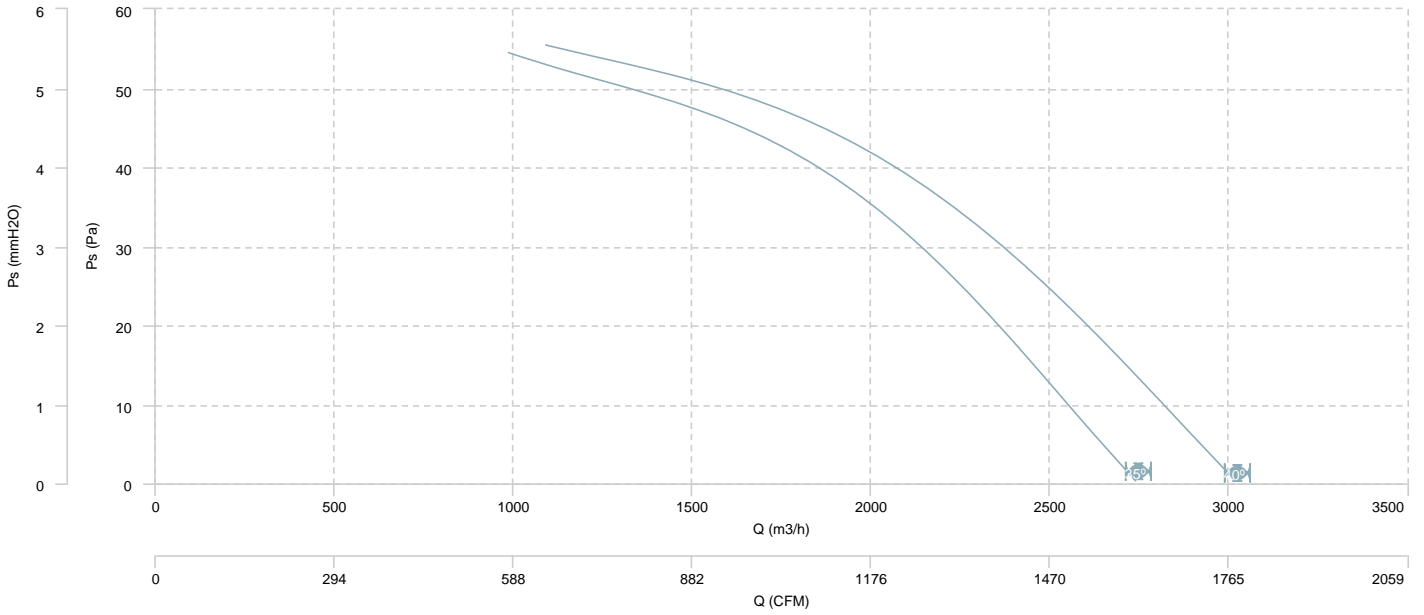

AIR FLOW - MECHANICAL POWER

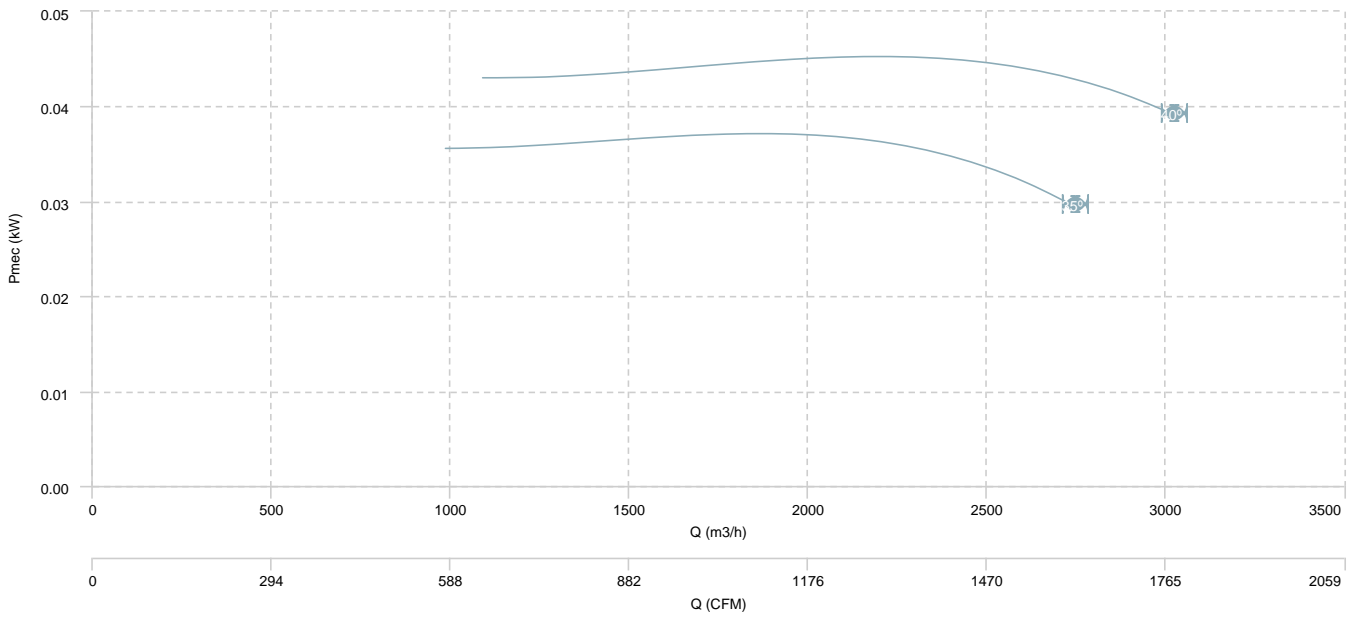

HB 40 T4/T8 (A0:6)

AIR FLOW - PRESSURE (4 poles)

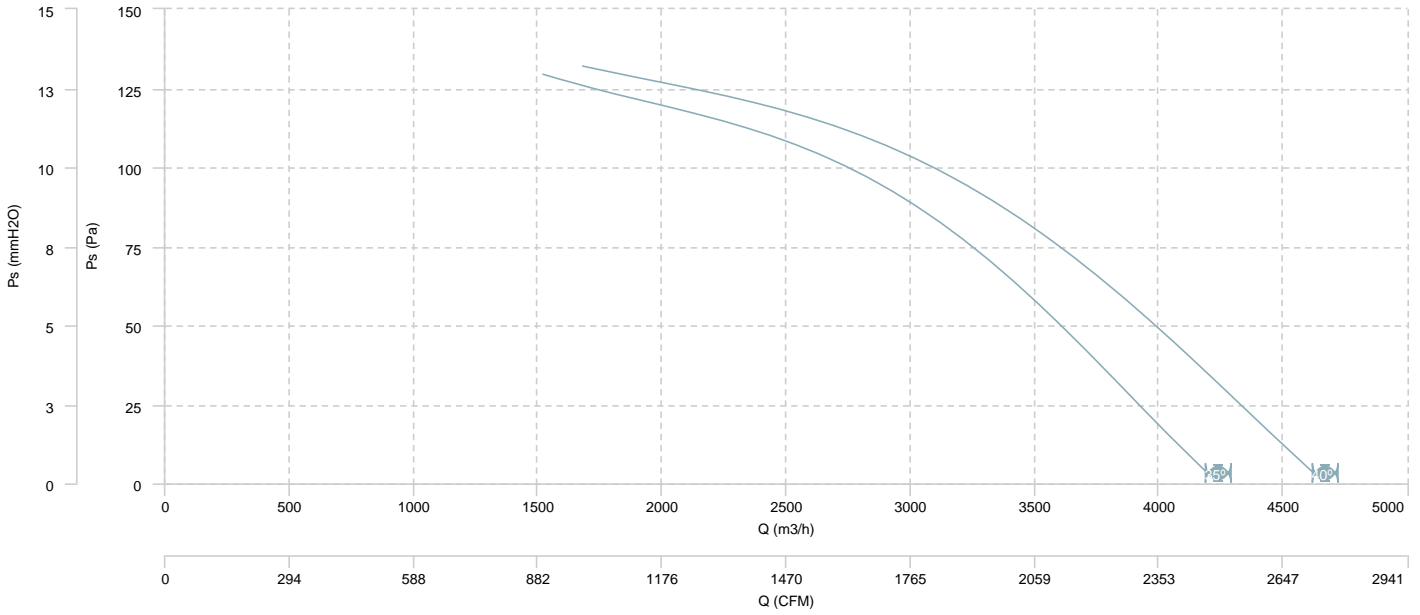

AIR FLOW - MECHANICAL POWER (4 poles)

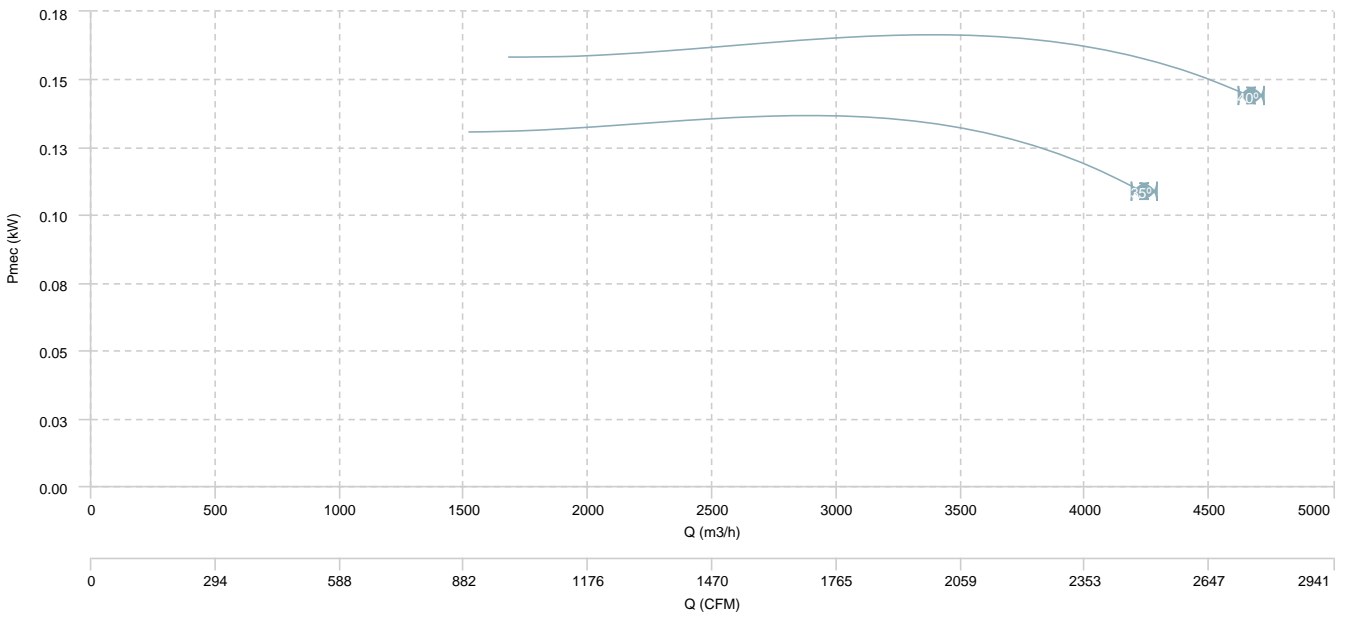

HB 40 T4/T8 (A0:6)

AIR FLOW - PRESSURE (8 poles)

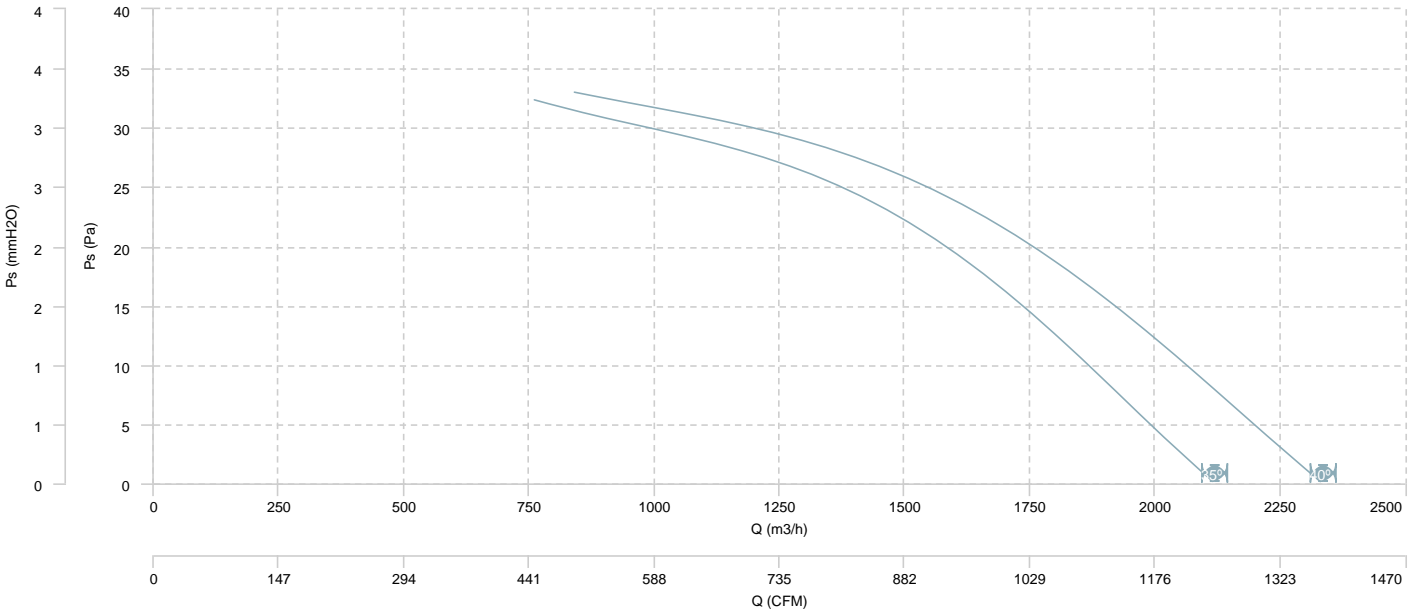

AIR FLOW - MECHANICAL POWER (8 poles)

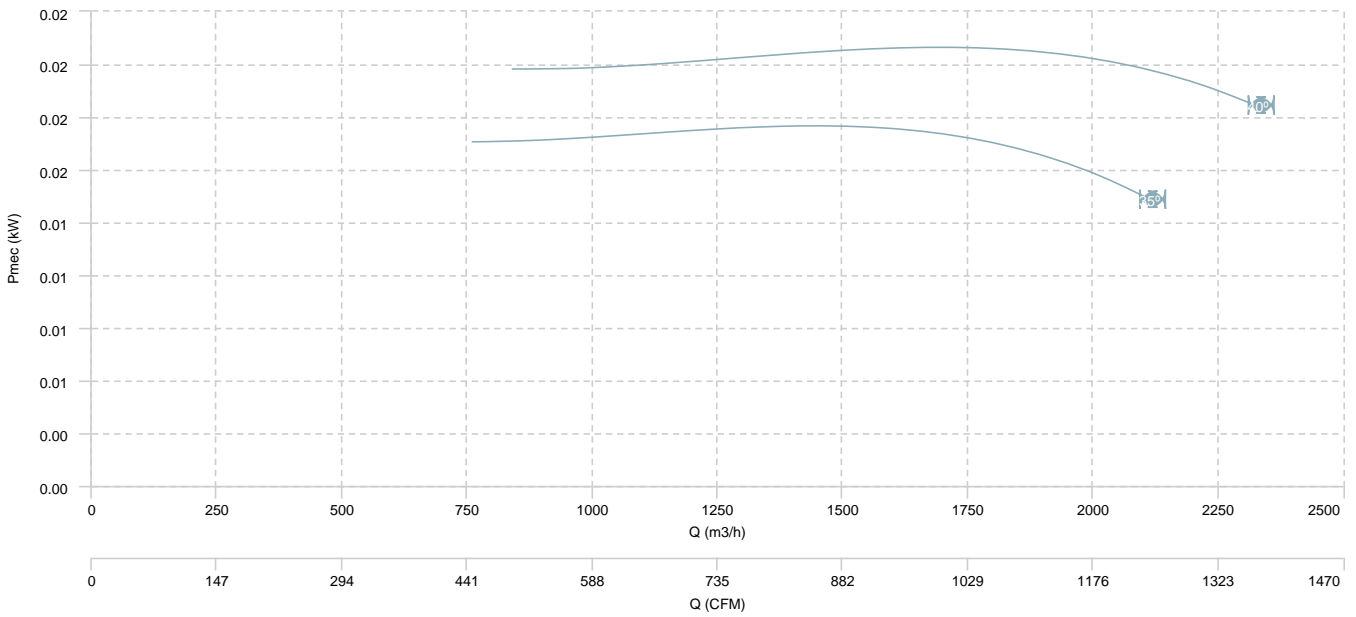

HB 45 T4 (A5:6)

AIR FLOW - PRESSURE

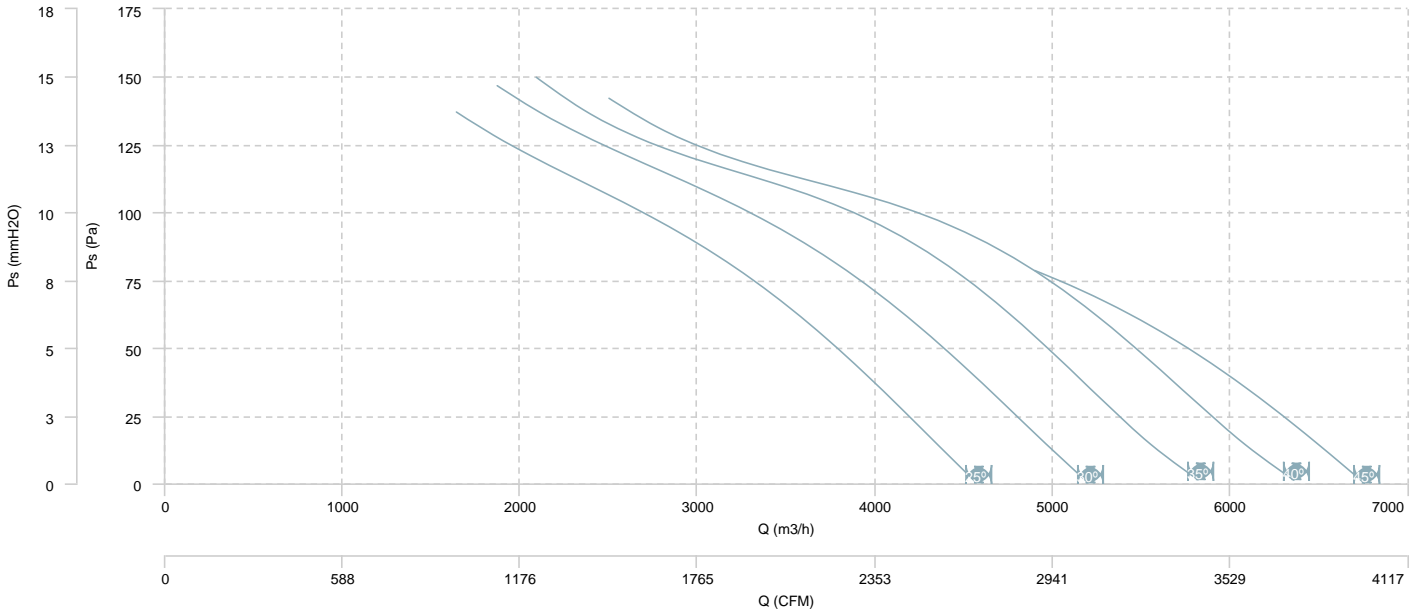

AIR FLOW - MECHANICAL POWER

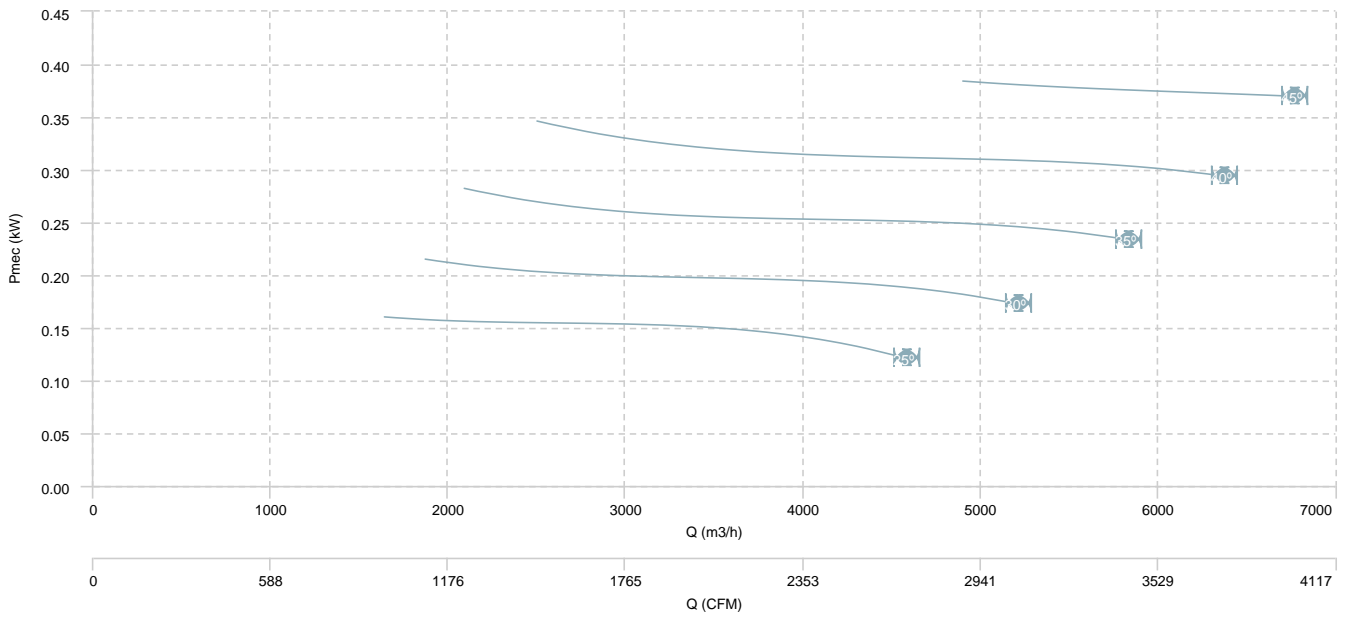

HB 45 T4 (A0:6)

AIR FLOW - PRESSURE

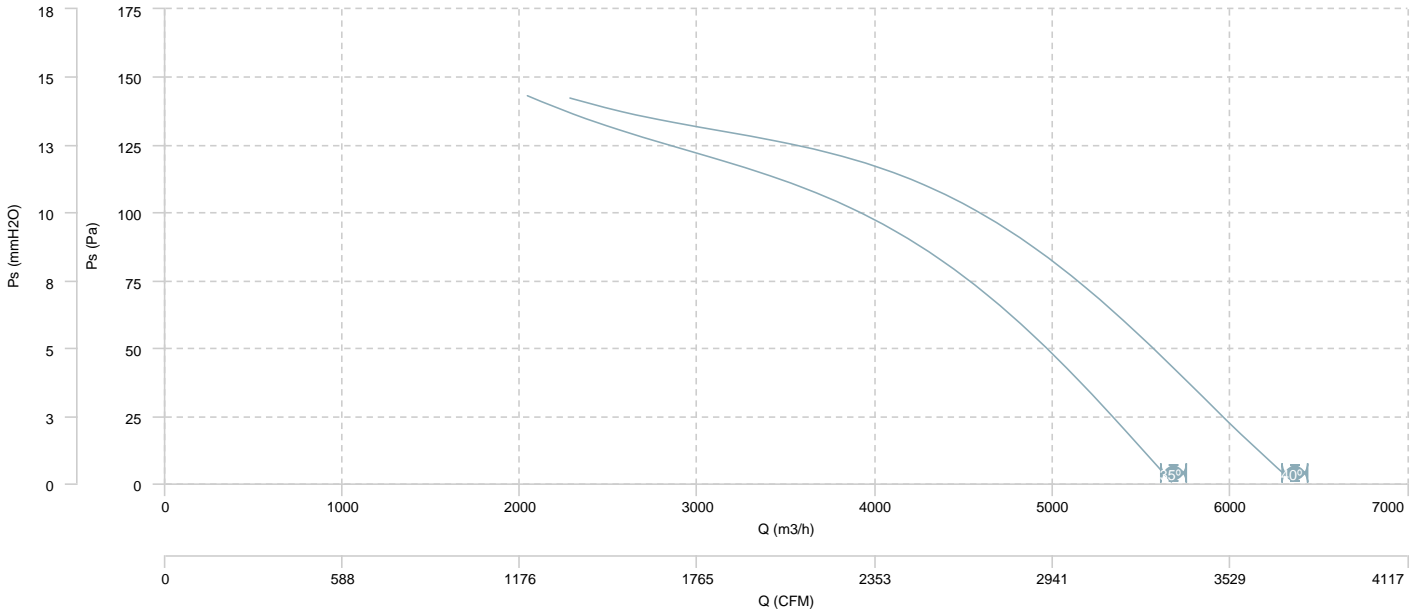

AIR FLOW - MECHANICAL POWER

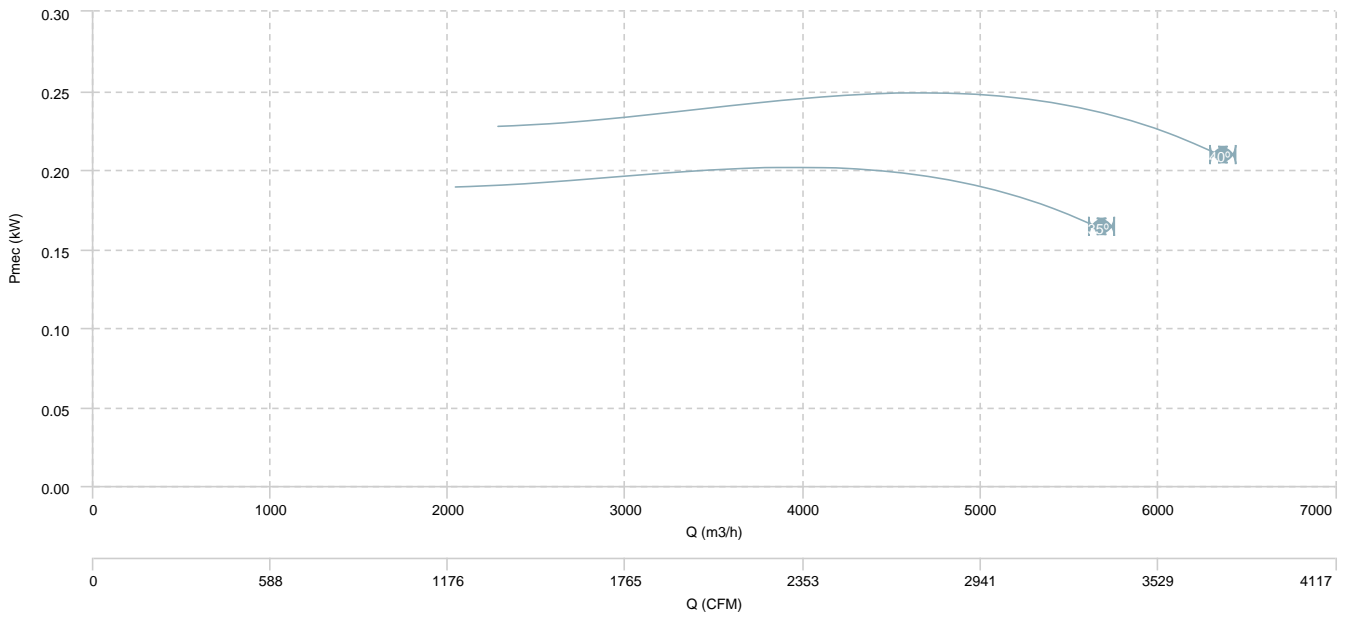

HB 45 T6 (A0:6)

AIR FLOW - PRESSURE

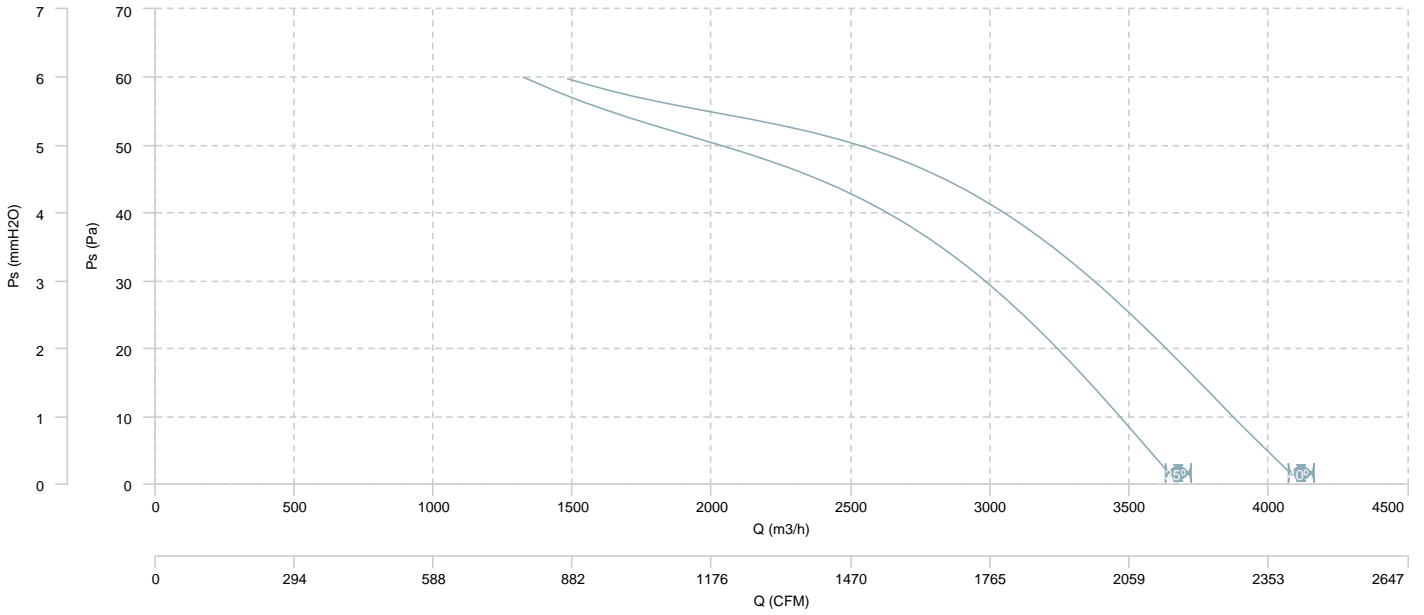

AIR FLOW - MECHANICAL POWER

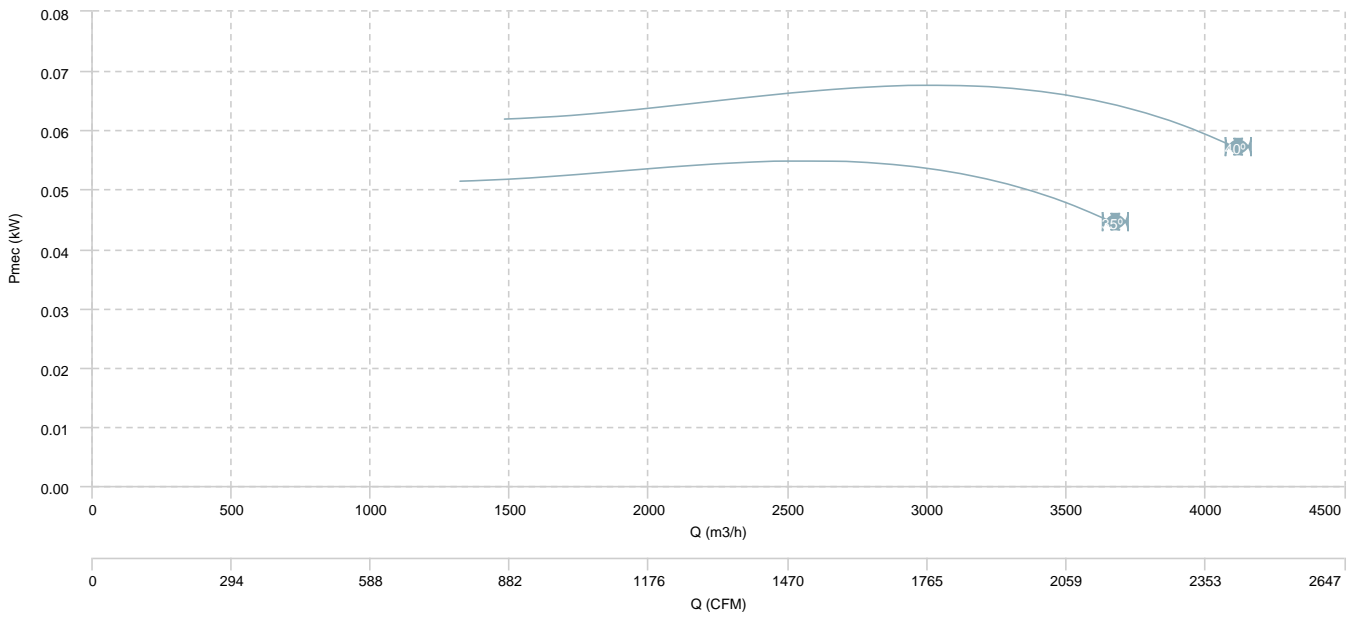

HB 45 T6 (A5:6)

AIR FLOW - PRESSURE

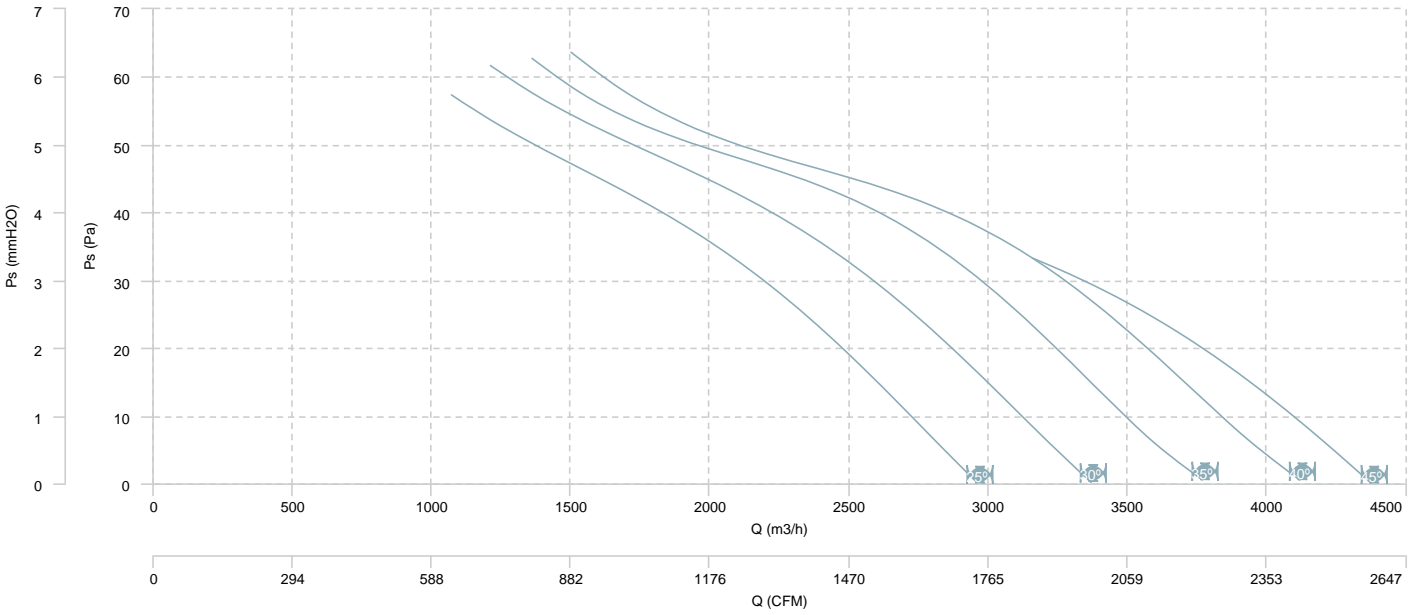

AIR FLOW - MECHANICAL POWER

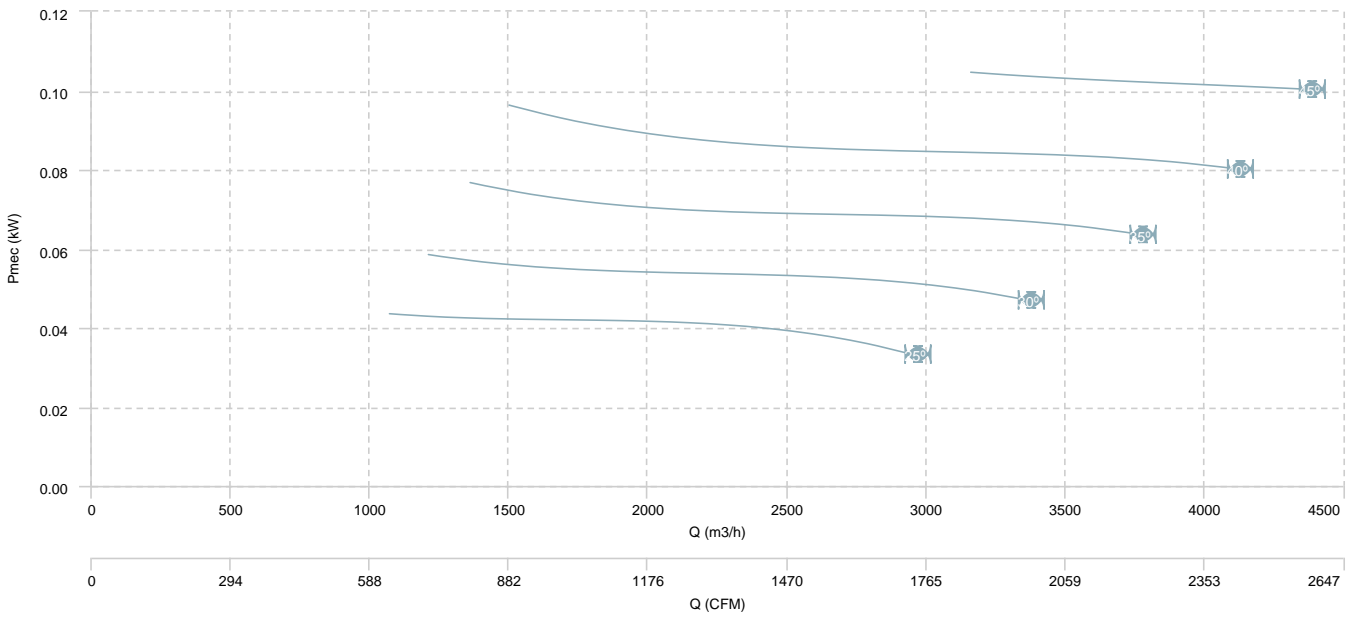

HB 45 T4/T8 (A0:6)

AIR FLOW - PRESSURE (4 poles)

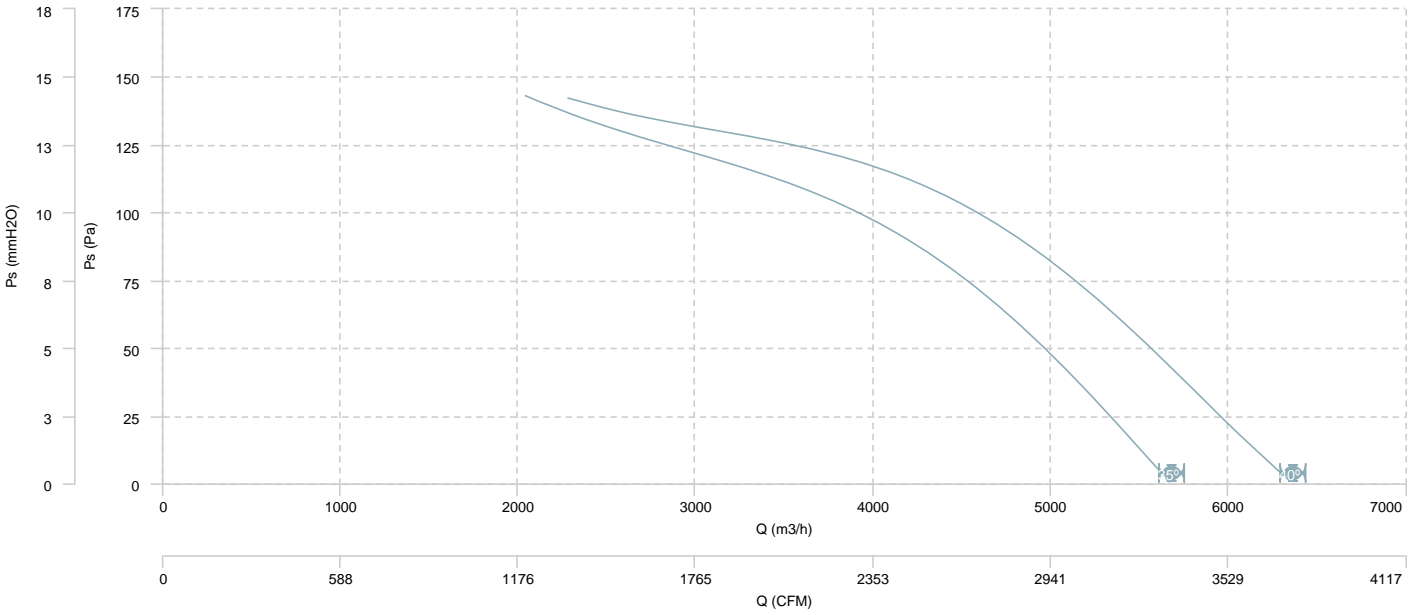

AIR FLOW - MECHANICAL POWER (4 poles)

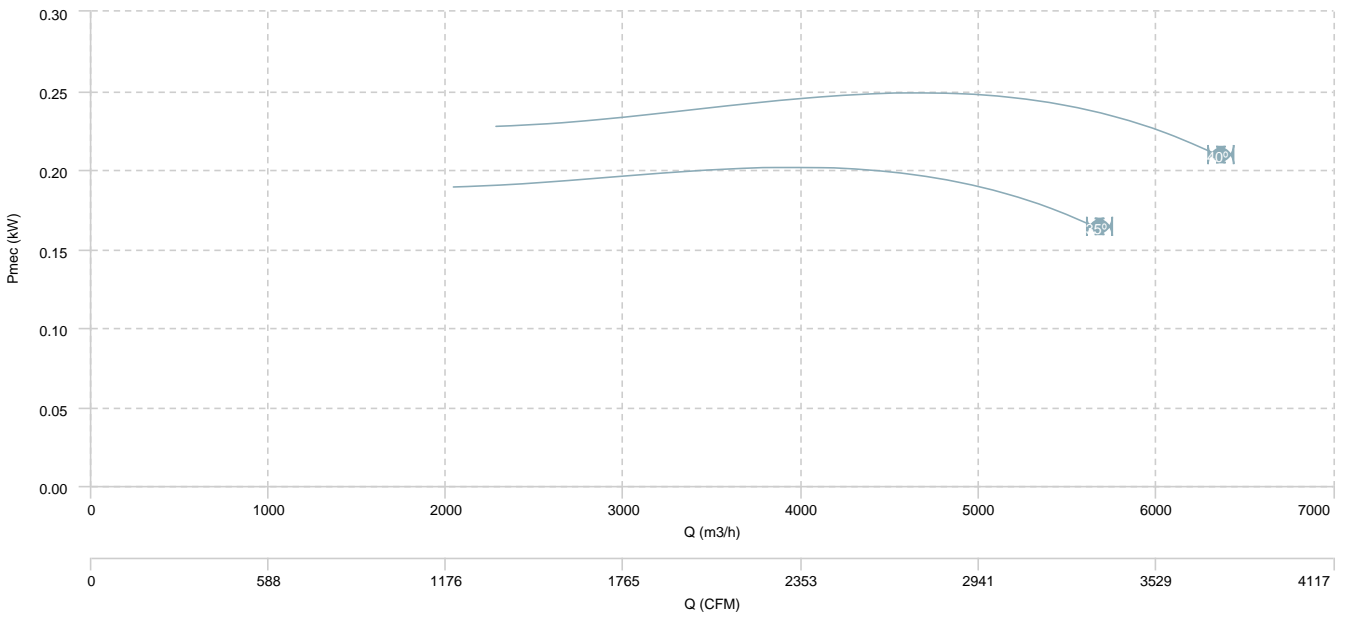

HB 45 T4/T8 (A0:6)

AIR FLOW - PRESSURE (8 poles)

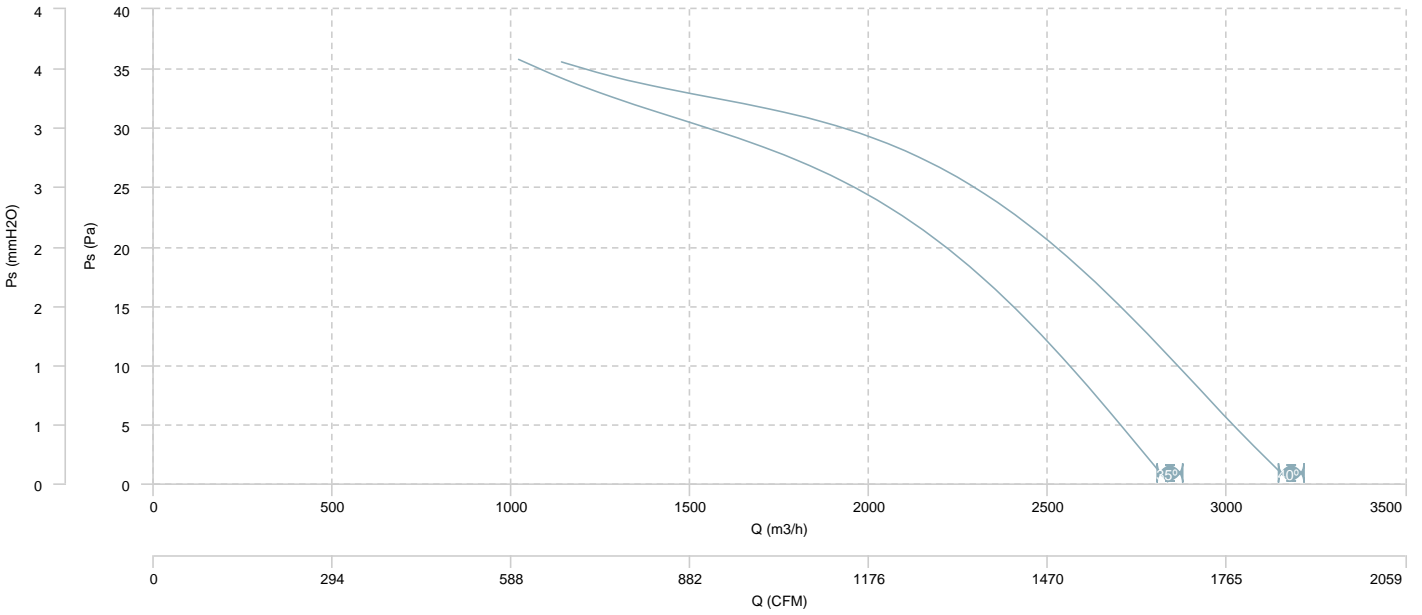

AIR FLOW - MECHANICAL POWER (8 poles)

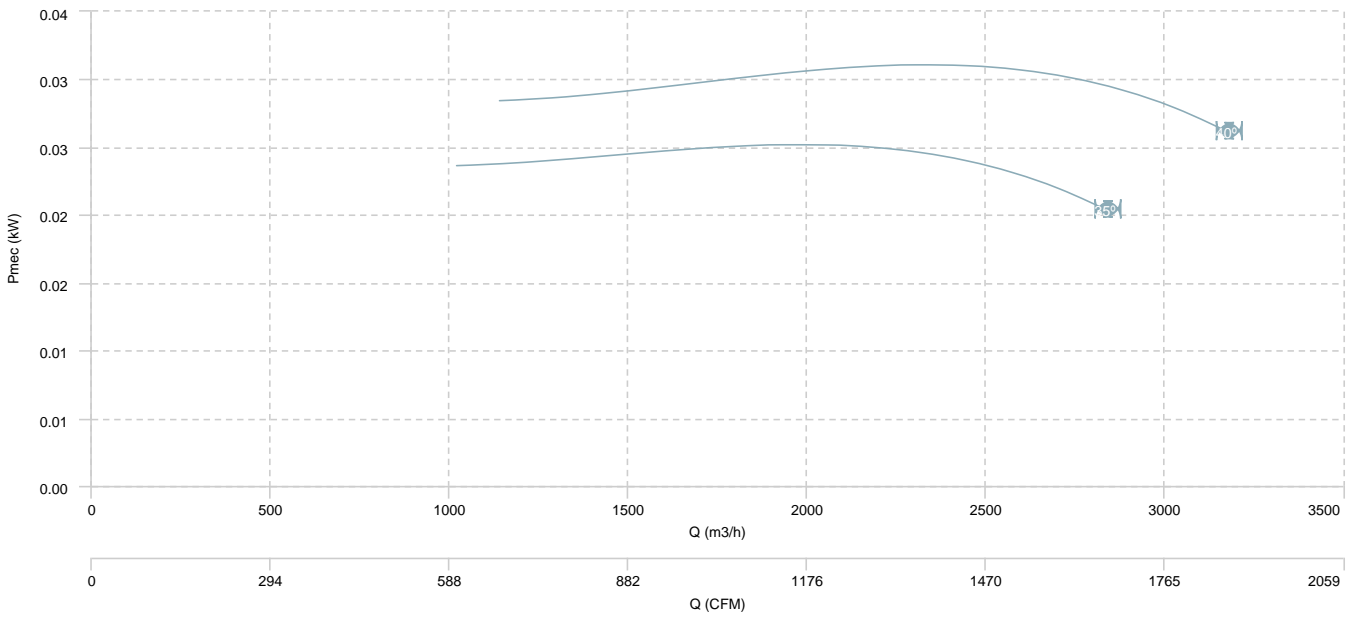

HB 45 T4/T8 (A5:6)

AIR FLOW - PRESSURE (4 poles)

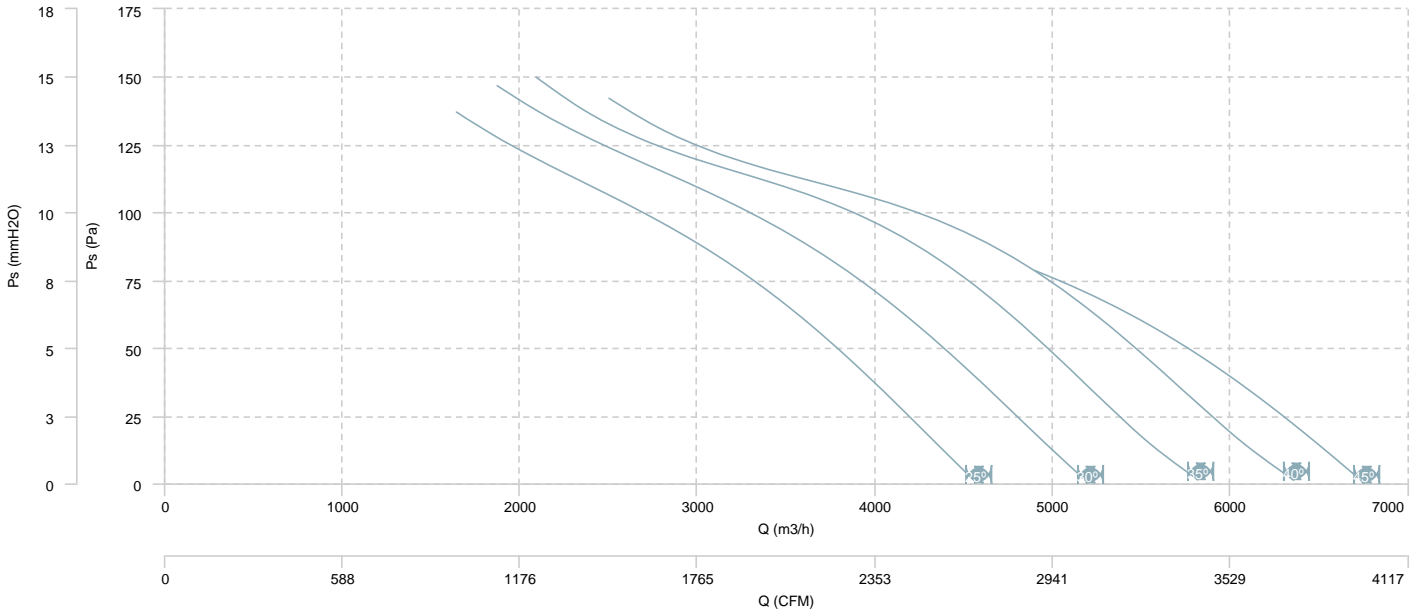

AIR FLOW - MECHANICAL POWER (4 poles)

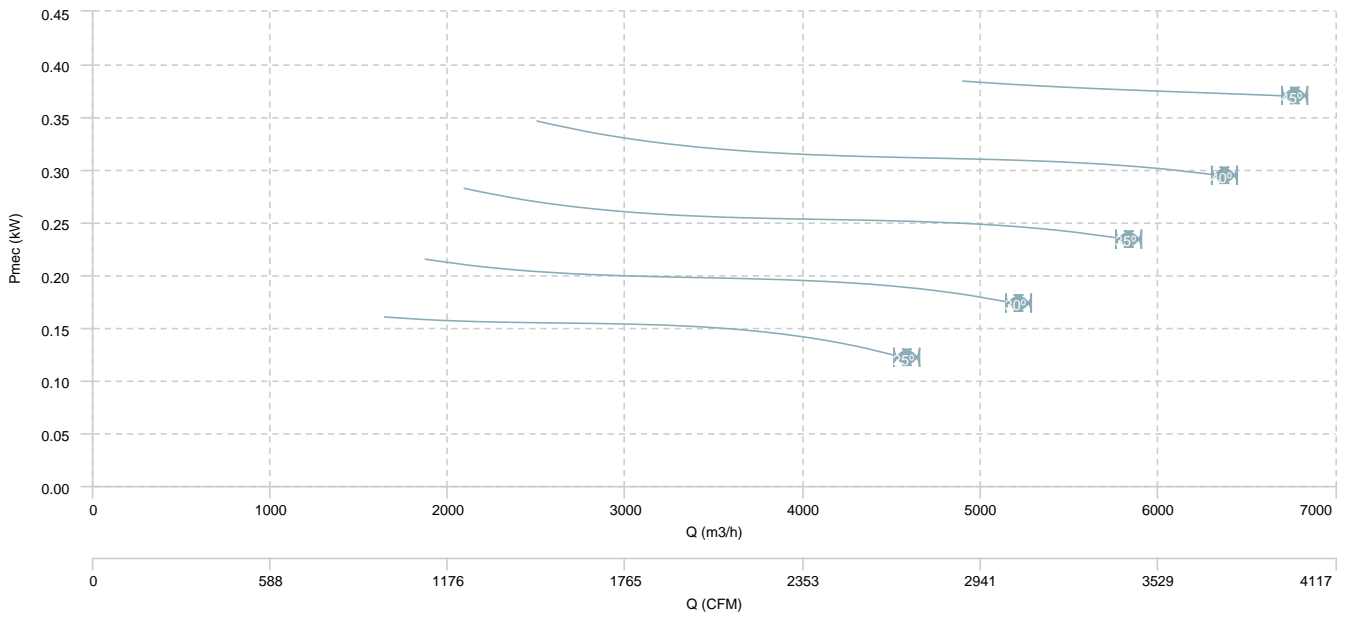

HB 45 T4/T8 (A5:6)

AIR FLOW - PRESSURE (8 poles)

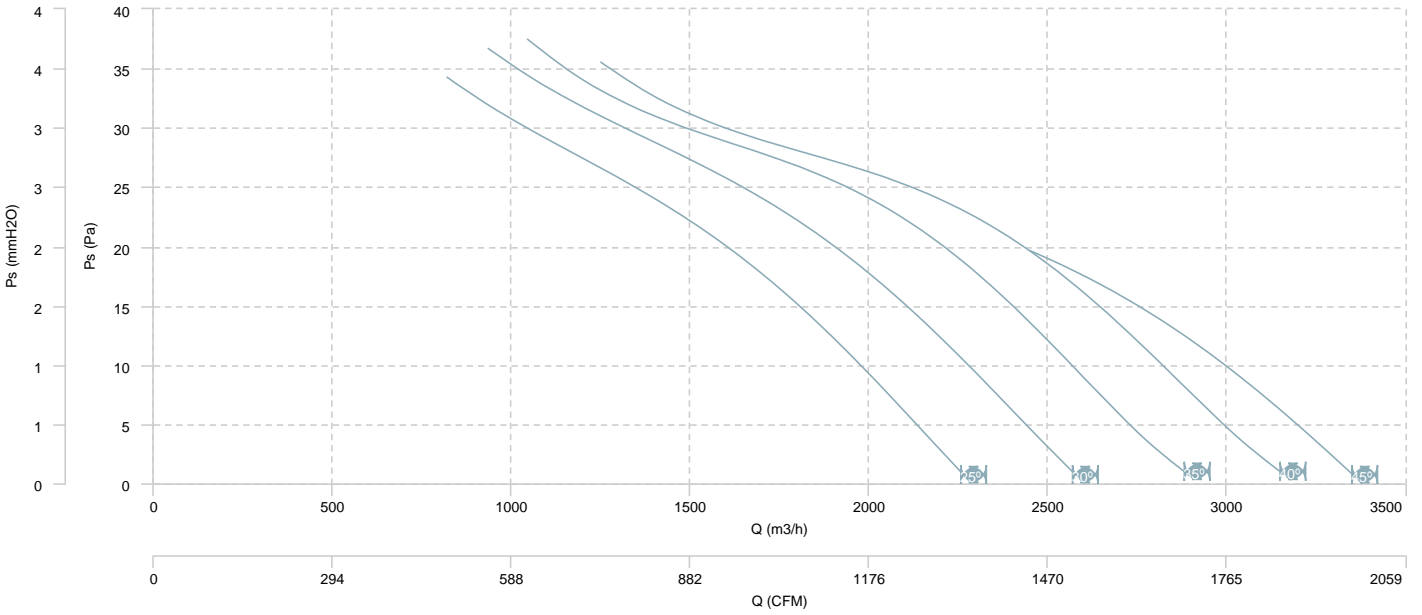

AIR FLOW - MECHANICAL POWER (8 poles)

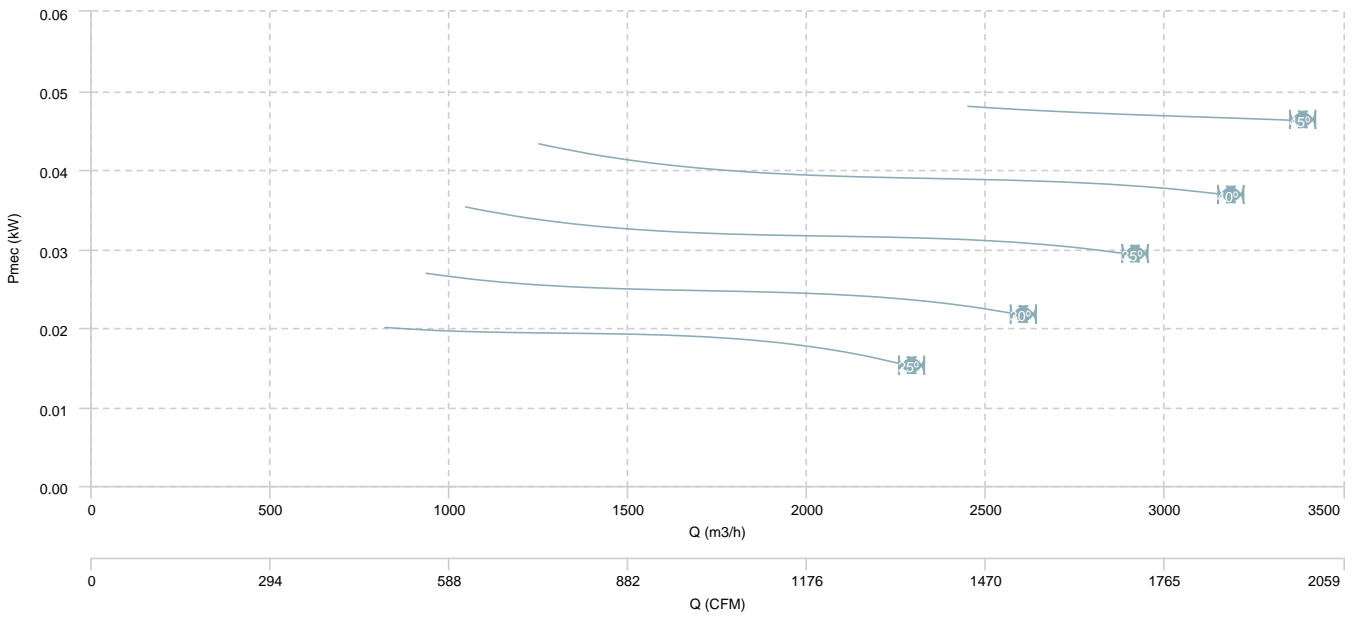

HB 50 T4 (A5:6)

AIR FLOW - PRESSURE

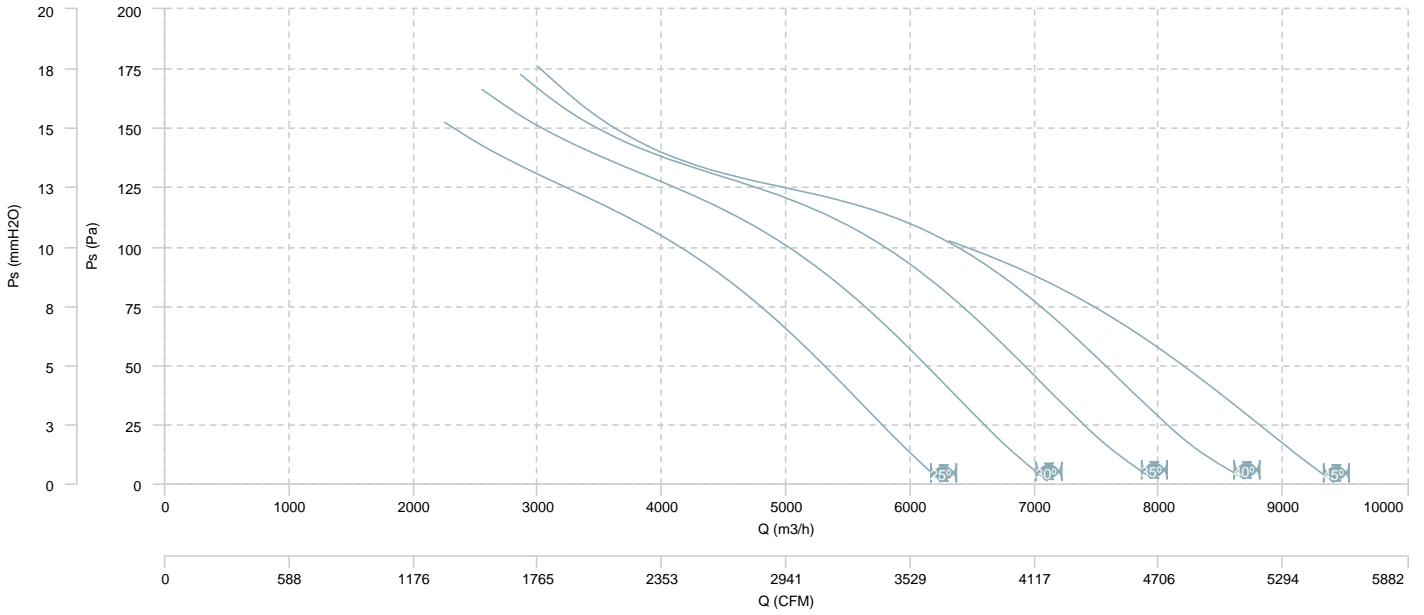

AIR FLOW - MECHANICAL POWER

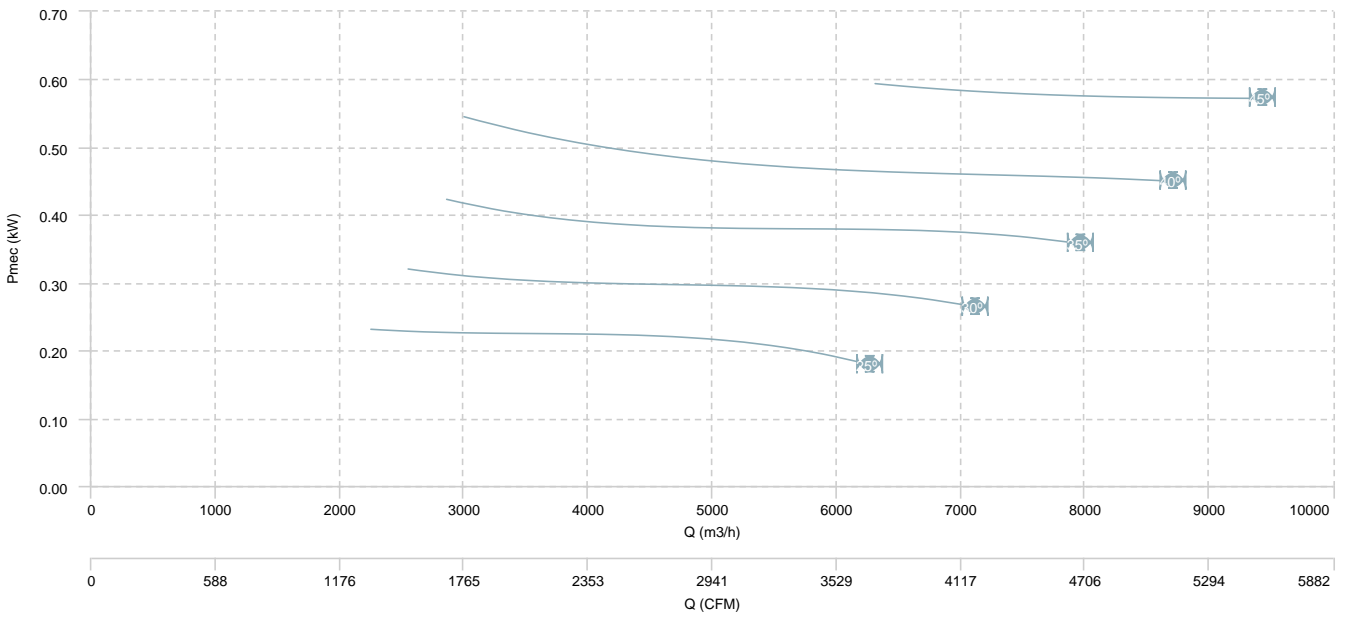

HB 50 T4 (A0:6)

AIR FLOW - PRESSURE

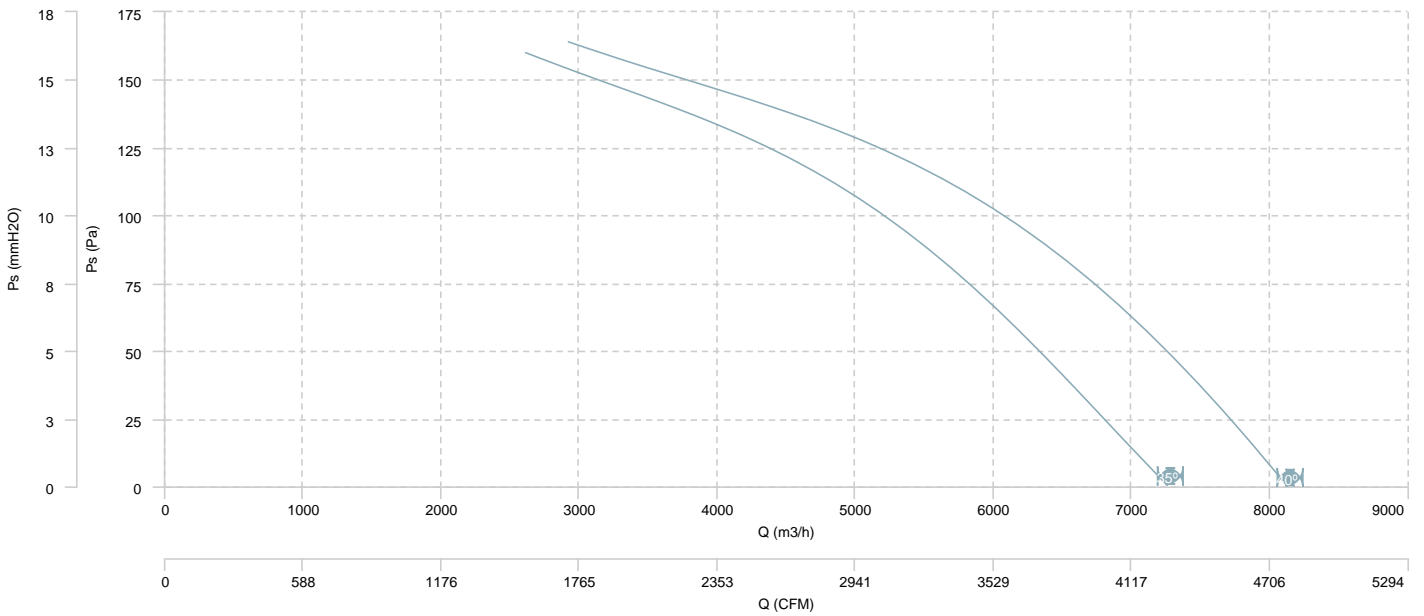

AIR FLOW - MECHANICAL POWER

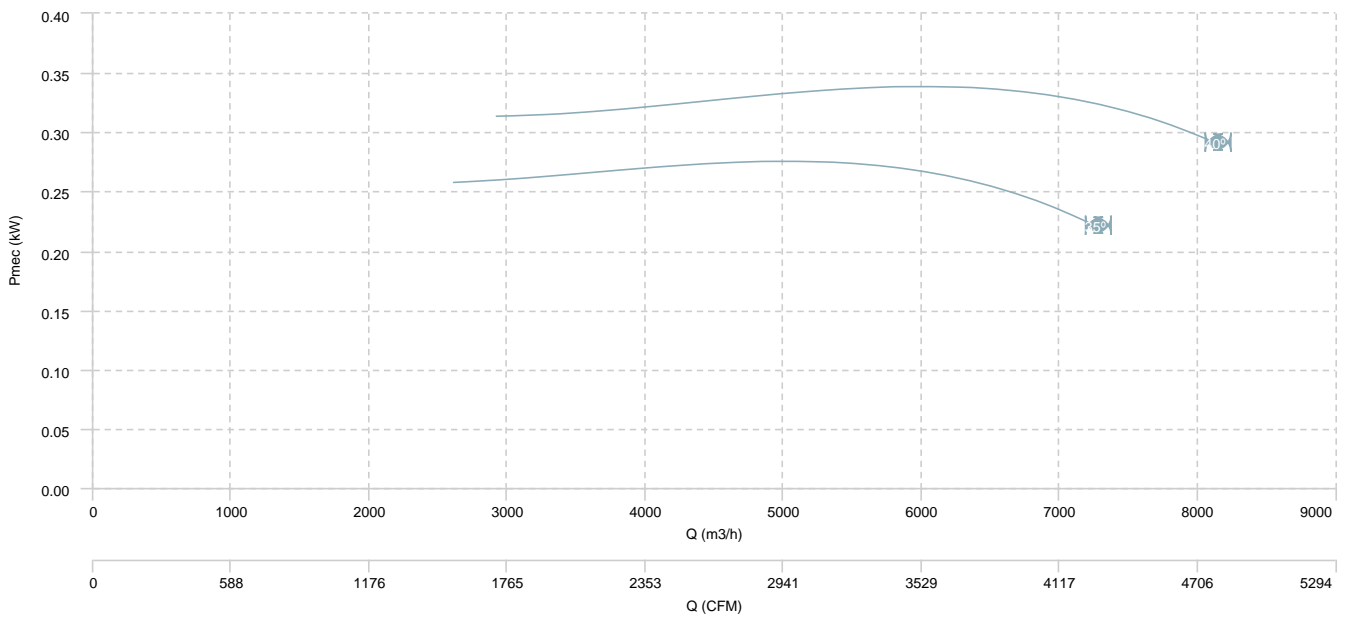

HB 50 T6 (A5:6)

AIR FLOW - PRESSURE

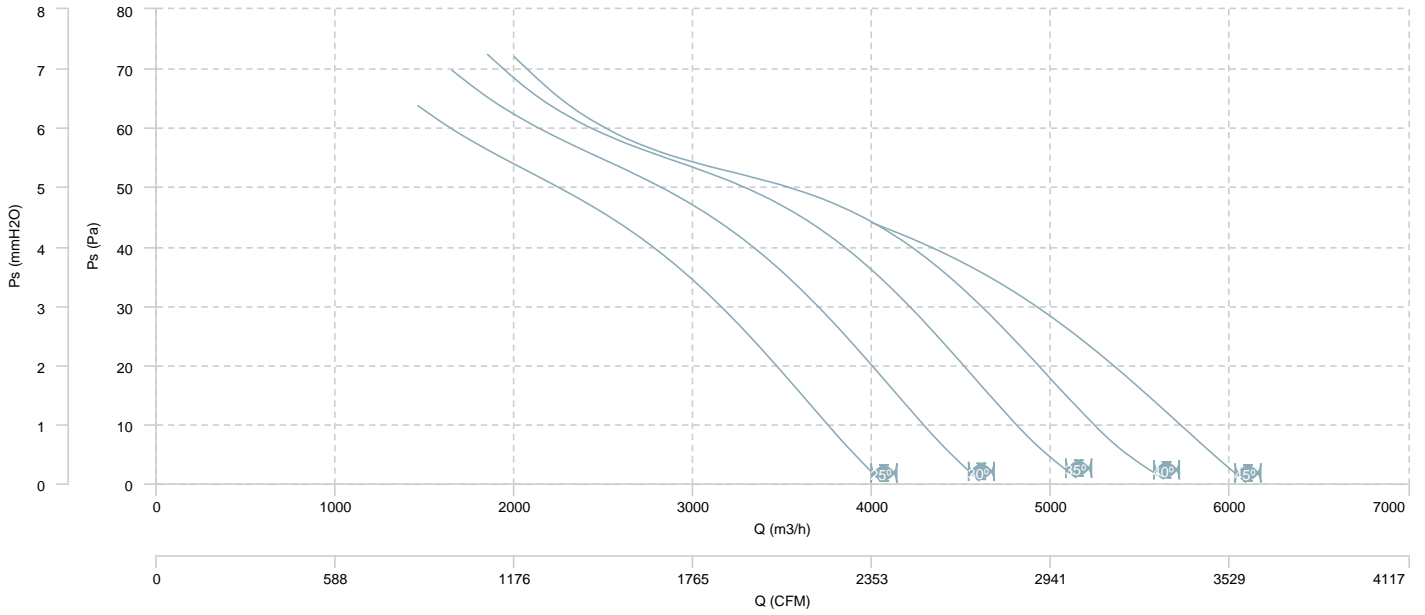

AIR FLOW - MECHANICAL POWER

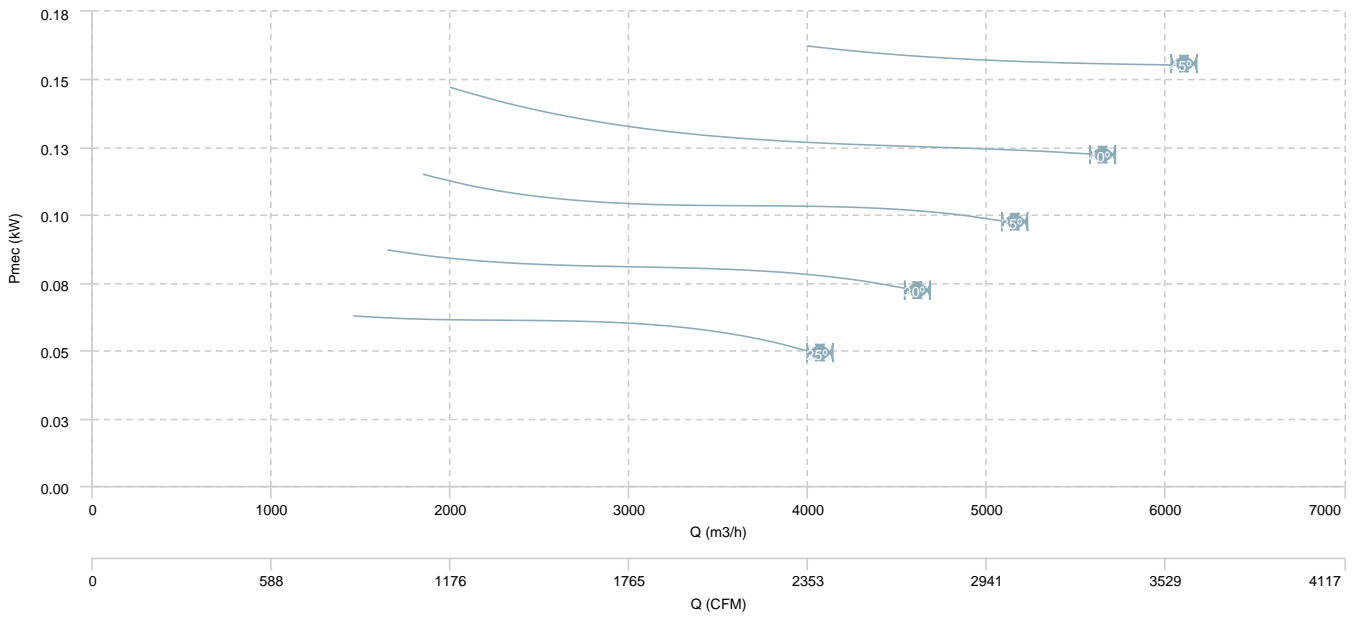

HB 50 T6 (A0:6)

AIR FLOW - PRESSURE

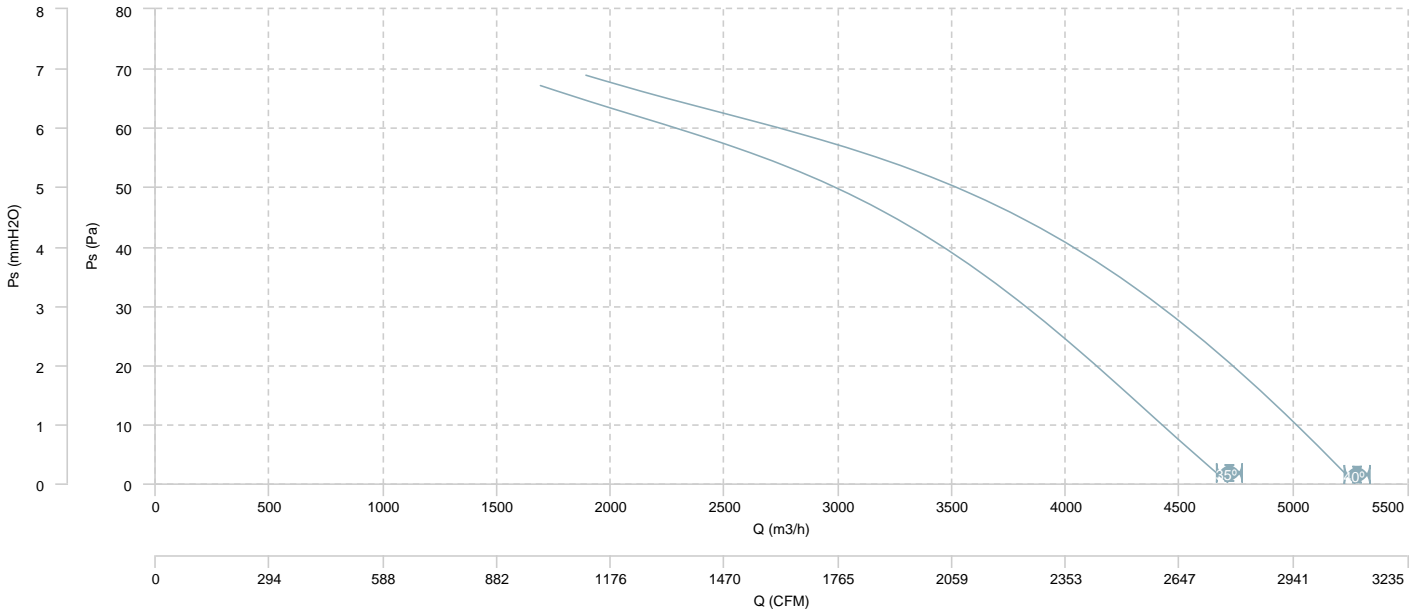

AIR FLOW - MECHANICAL POWER

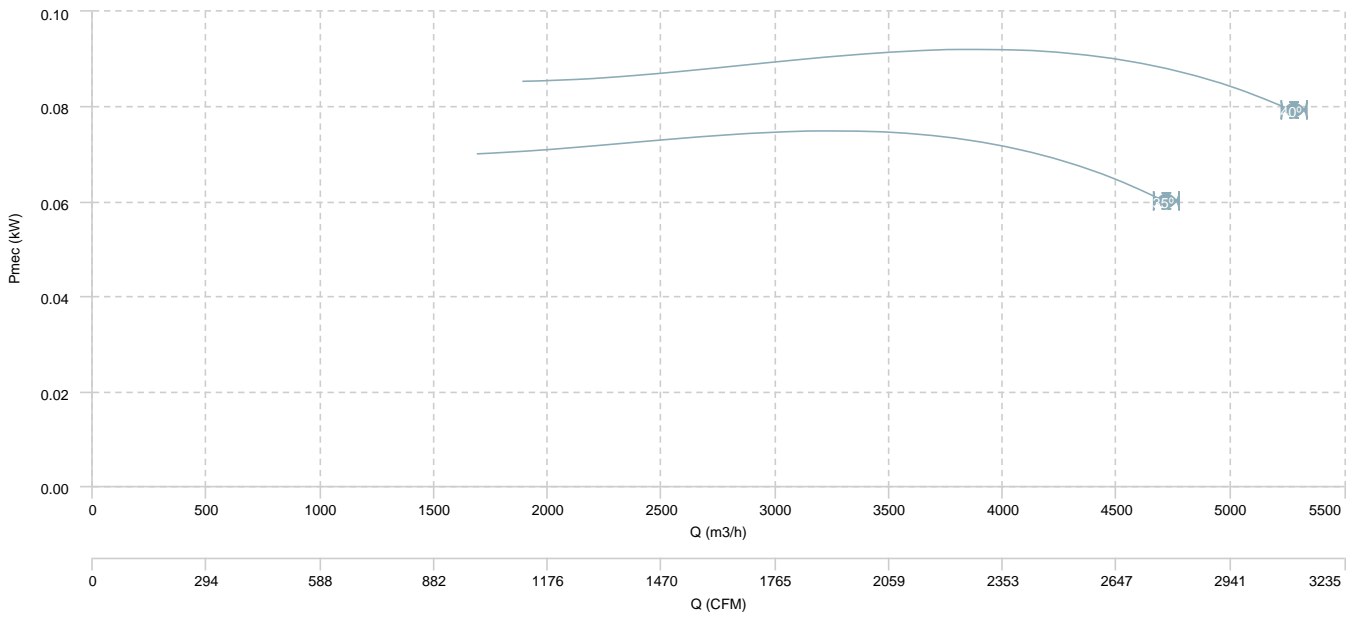

HB 50 T4/T8 (A5:6)

AIR FLOW - PRESSURE (4 poles)

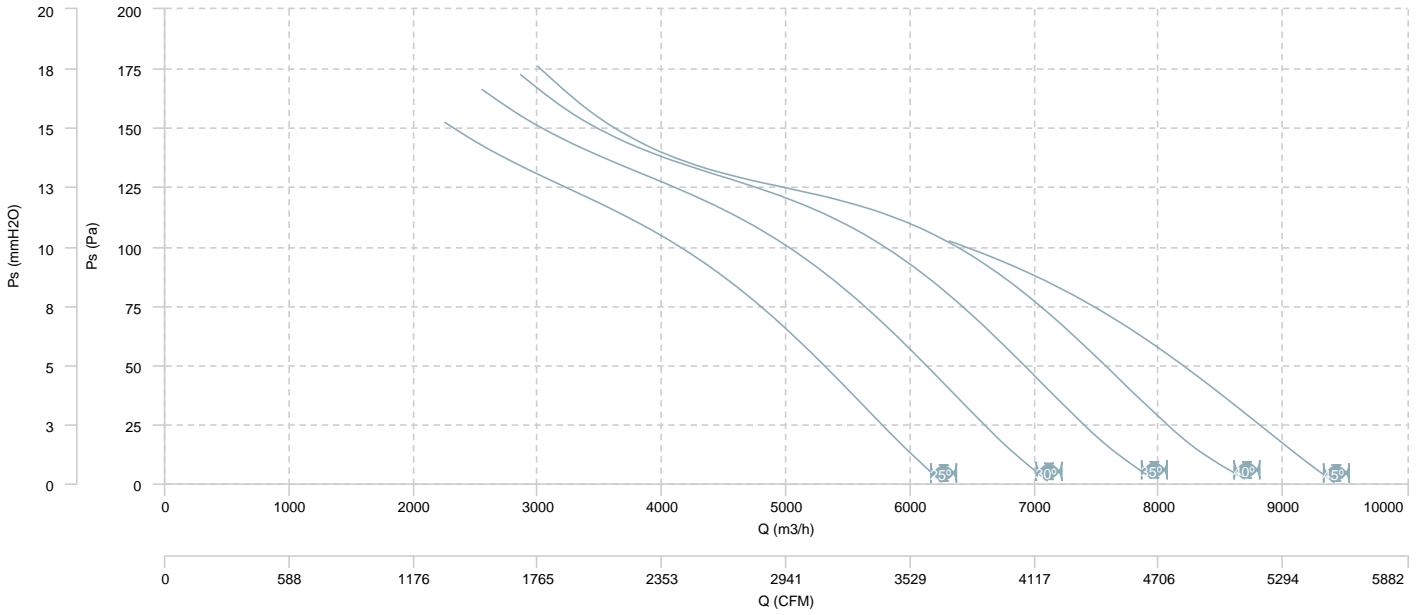

AIR FLOW - MECHANICAL POWER (4 poles)

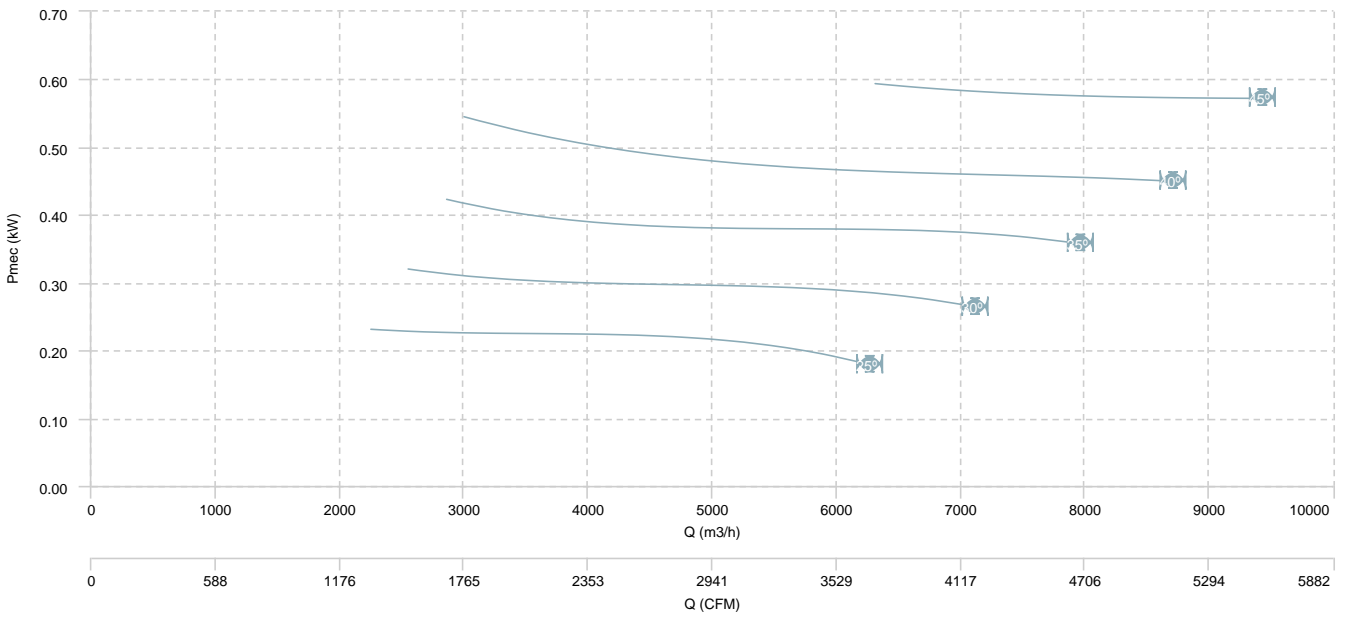

HB 50 T4/T8 (A5:6)

AIR FLOW - PRESSURE (8 poles)

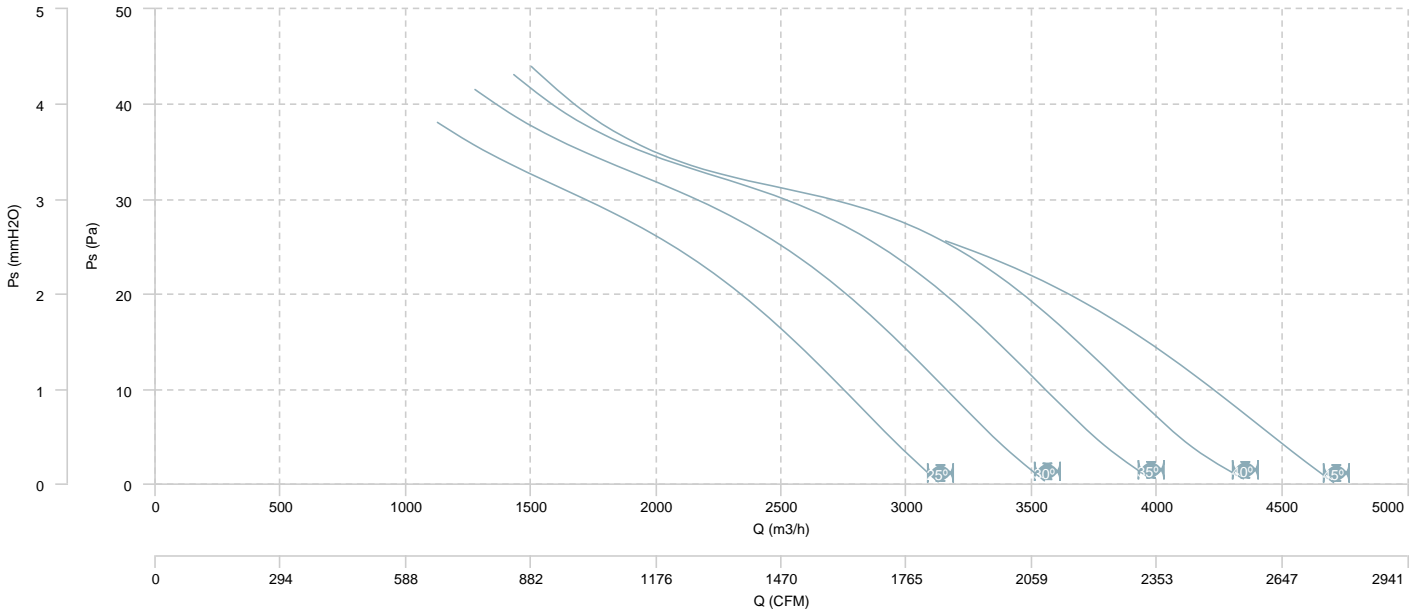

AIR FLOW - MECHANICAL POWER (8 poles)

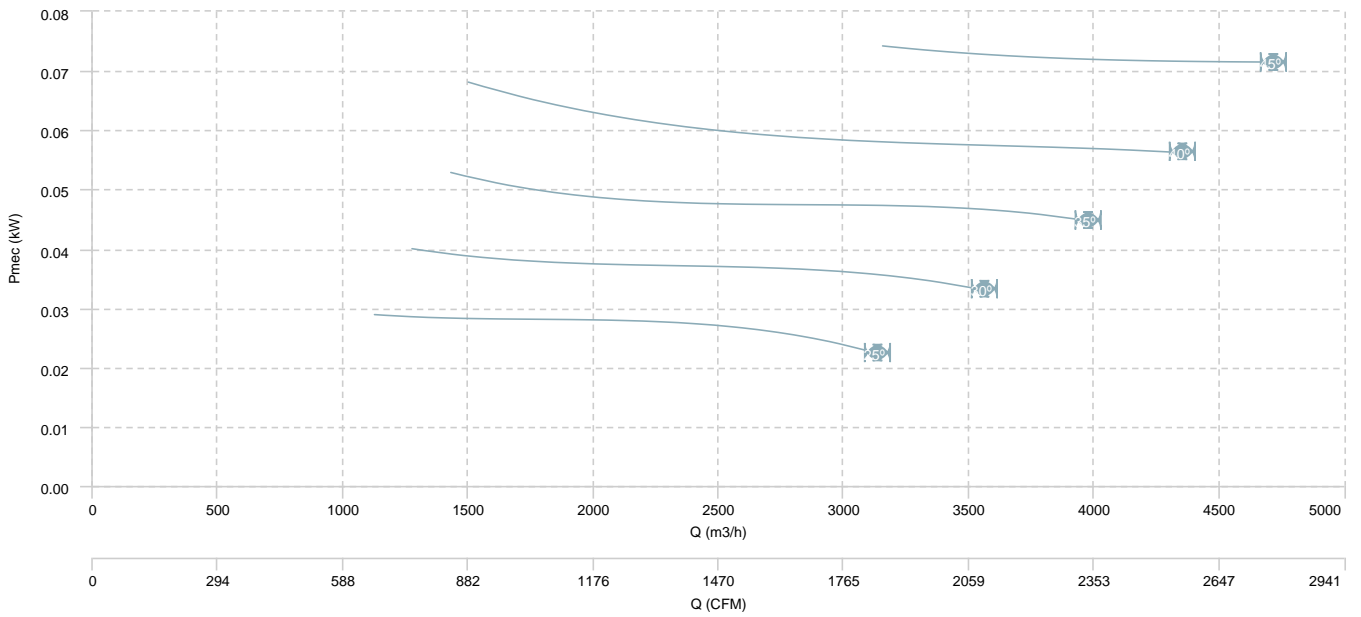

HB 50 T4/T8 (A0:6)

AIR FLOW - PRESSURE (4 poles)

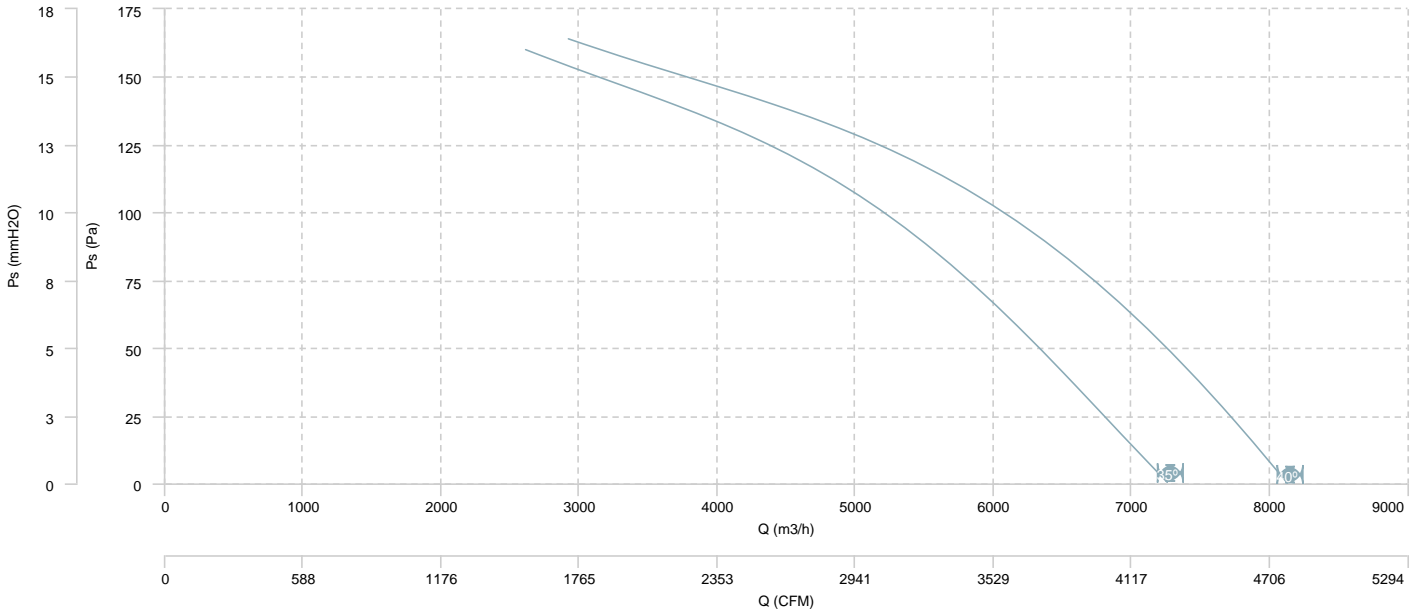

AIR FLOW - MECHANICAL POWER (4 poles)

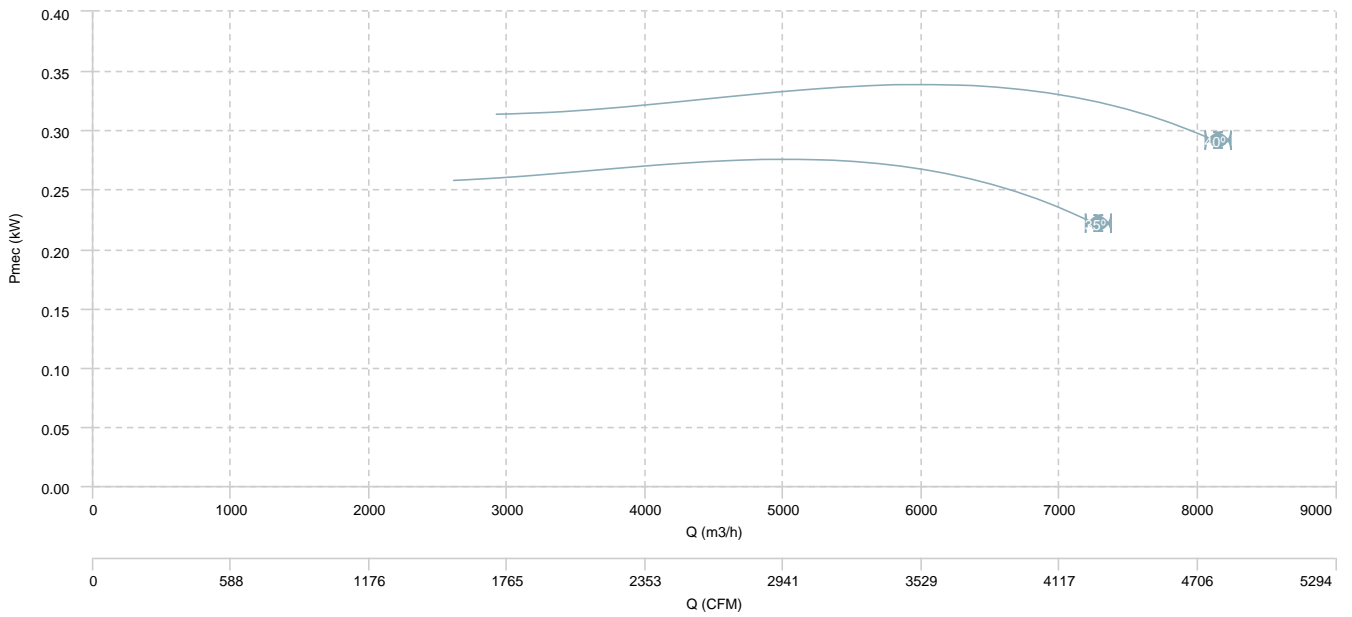

HB 50 T4/T8 (A0:6)

AIR FLOW - PRESSURE (8 poles)

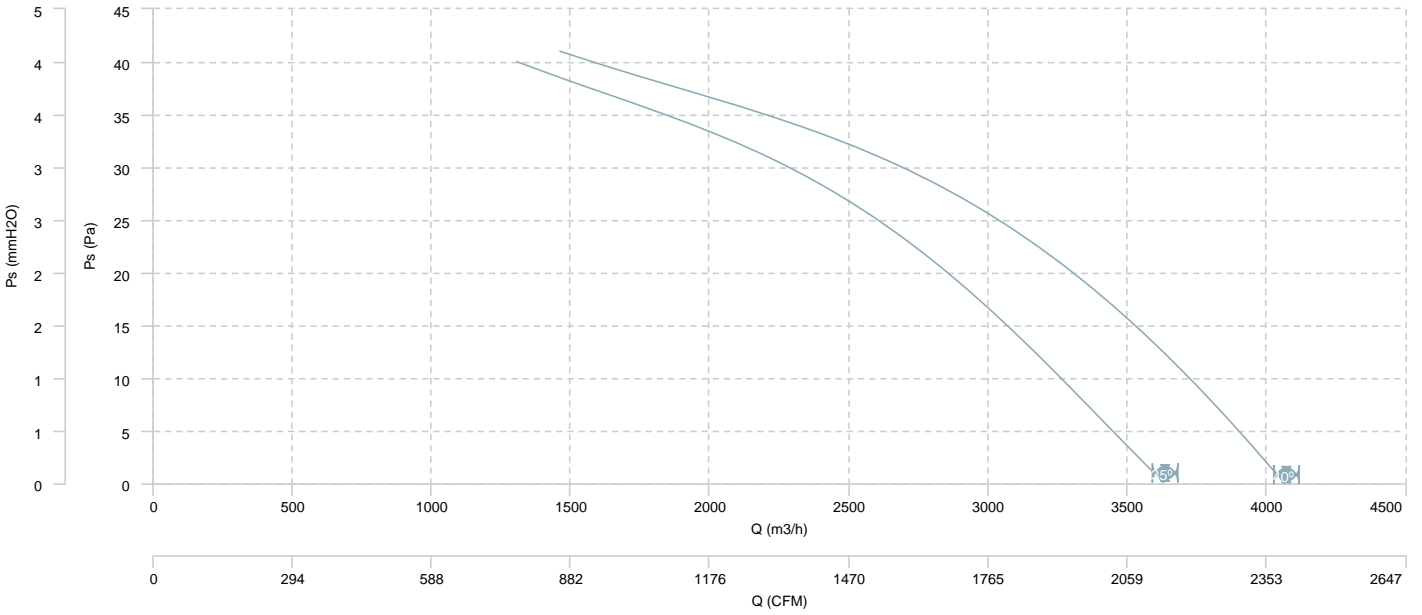

AIR FLOW - MECHANICAL POWER (8 poles)

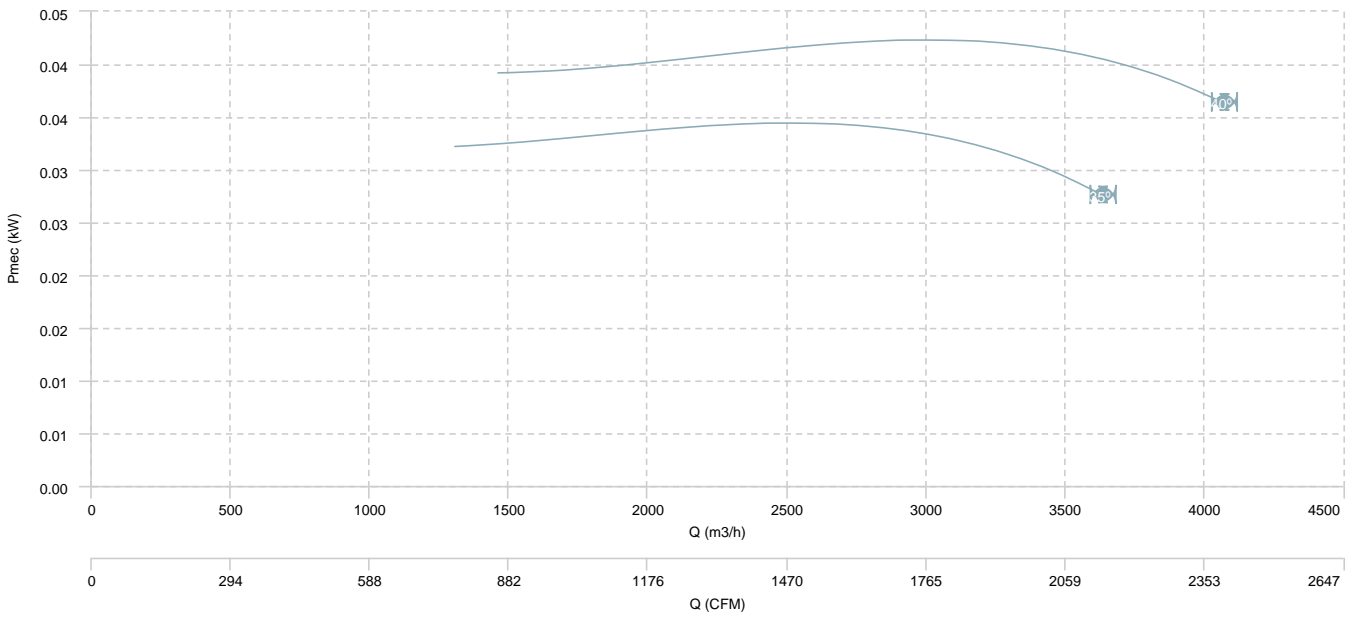

HB 56 T4 (A2:6)

AIR FLOW - PRESSURE

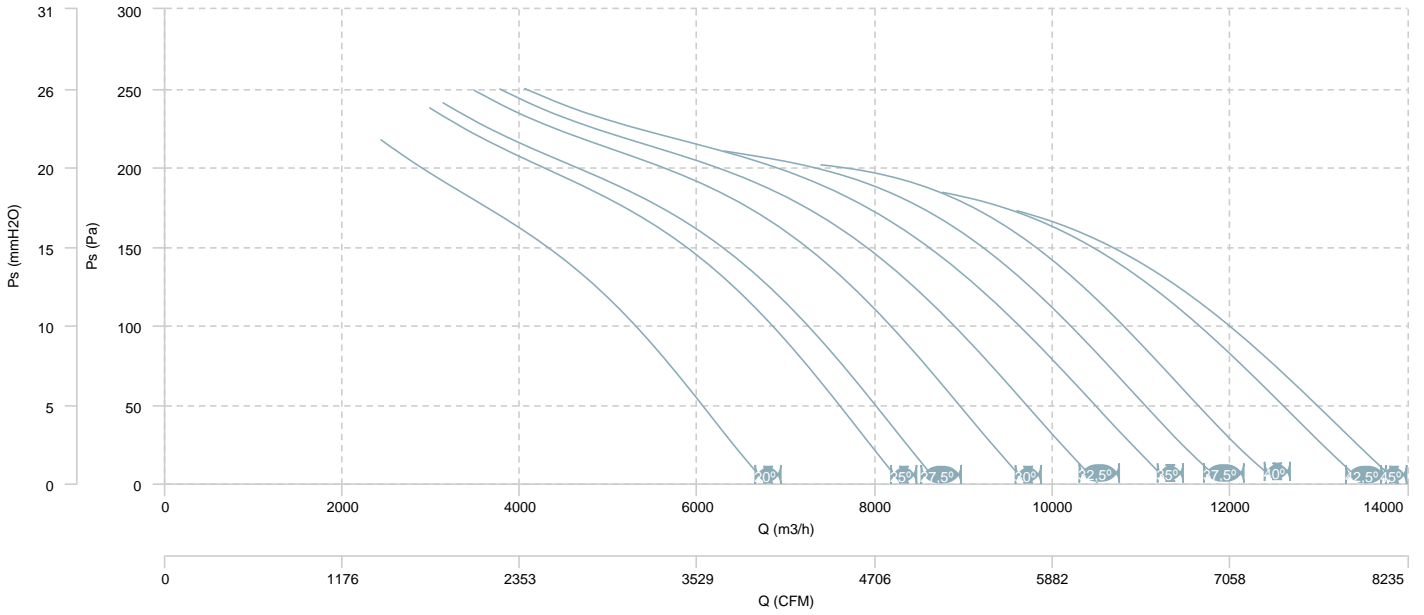

AIR FLOW - MECHANICAL POWER

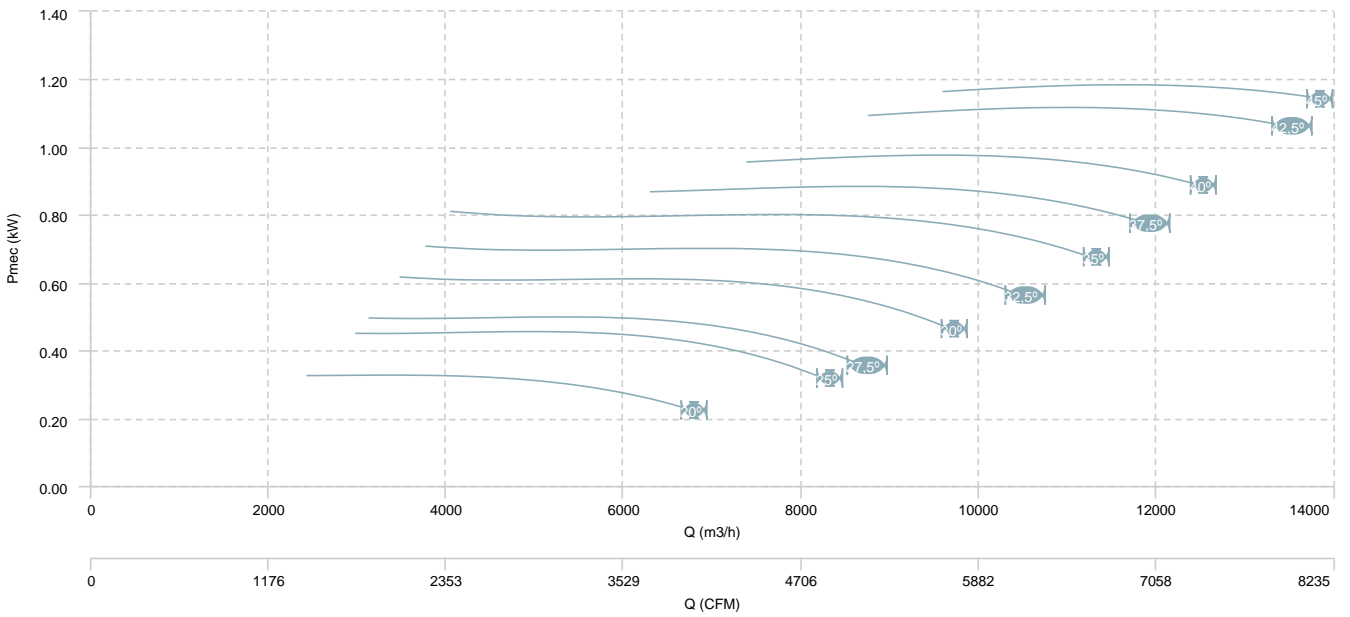

HB 56 T4 (A2:9)

AIR FLOW - PRESSURE

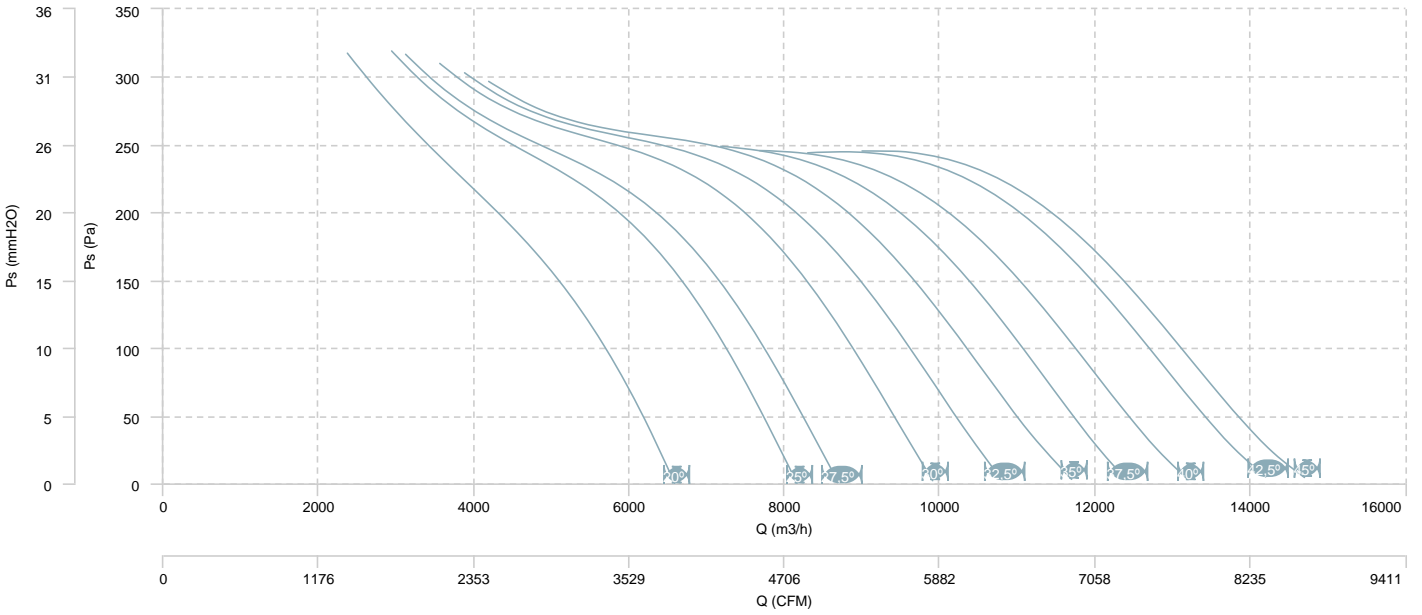

AIR FLOW - MECHANICAL POWER

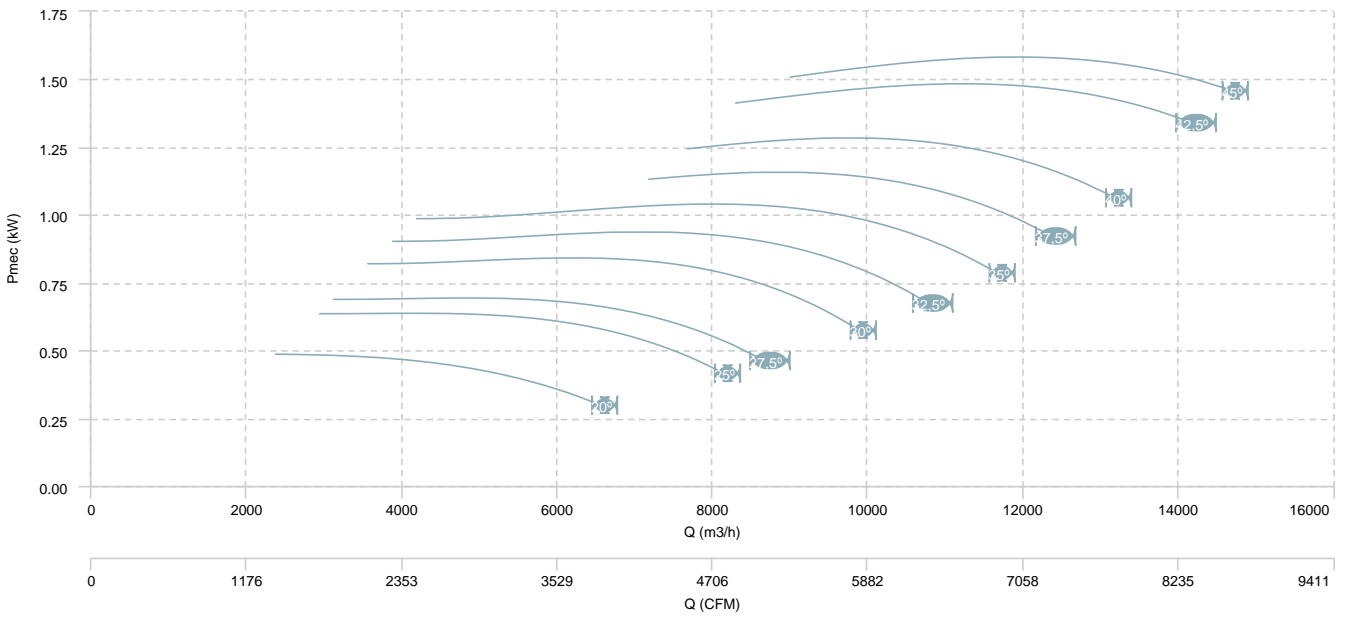

HB 56 T4 (A5:6)

AIR FLOW - PRESSURE

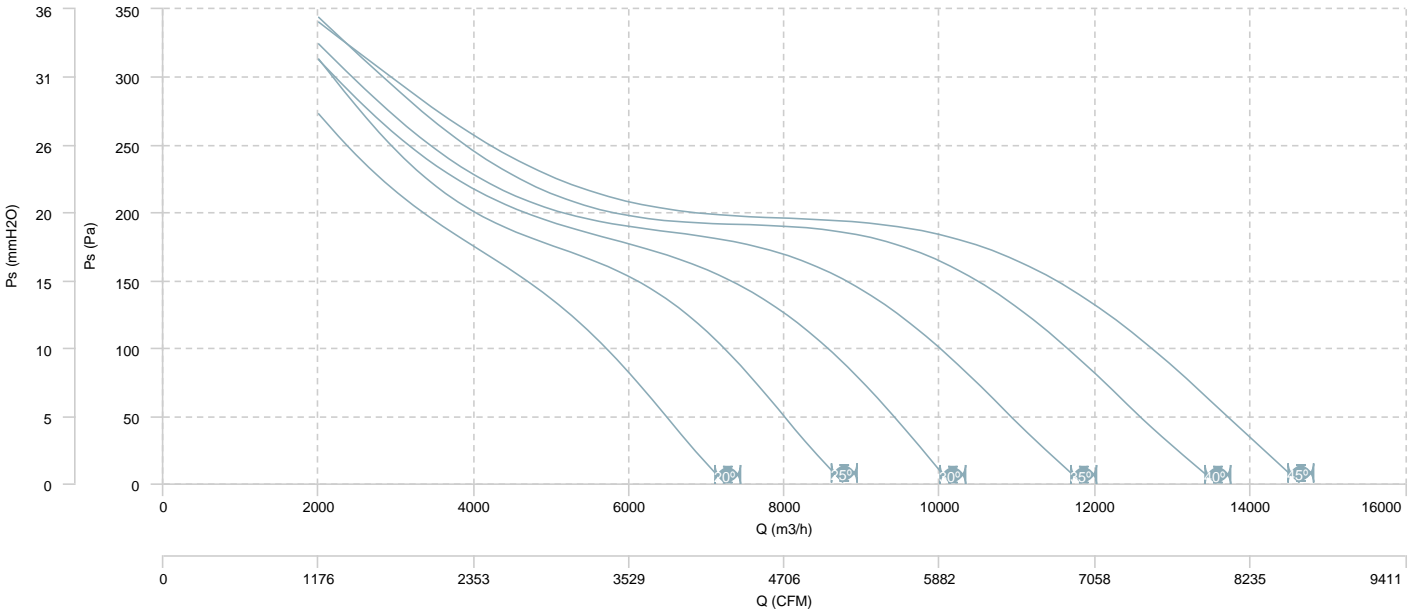

AIR FLOW - MECHANICAL POWER

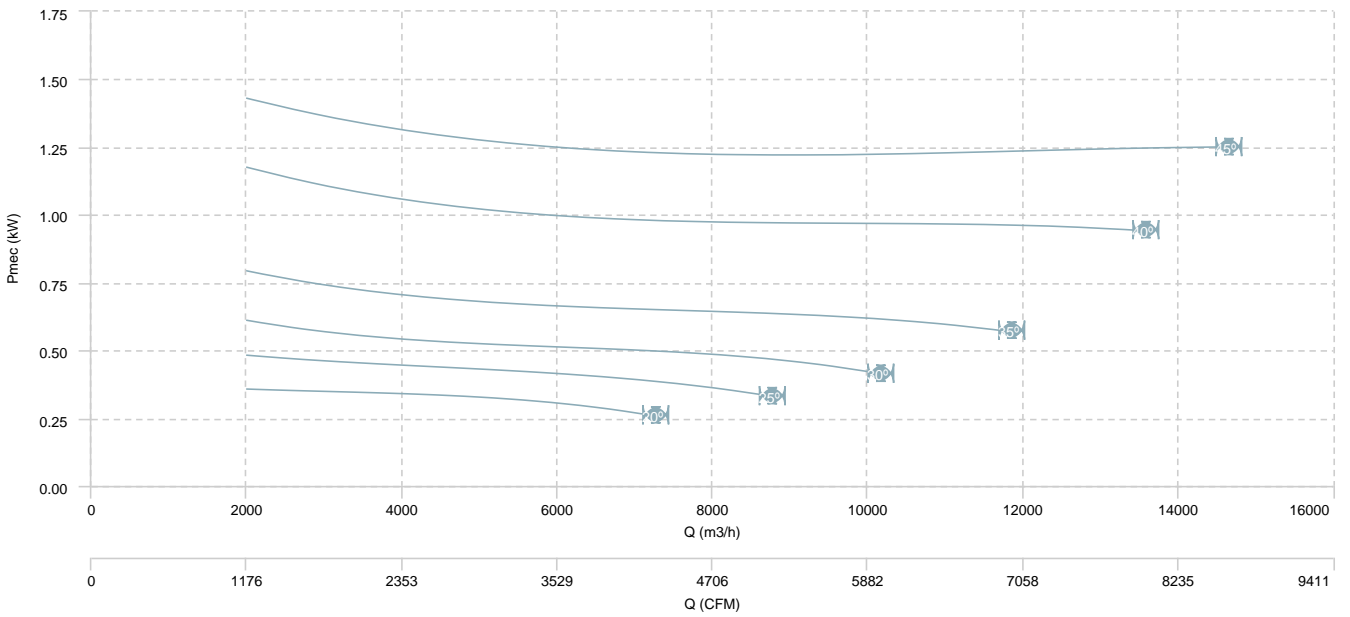

HB 56 T6 (A2:6)

AIR FLOW - PRESSURE

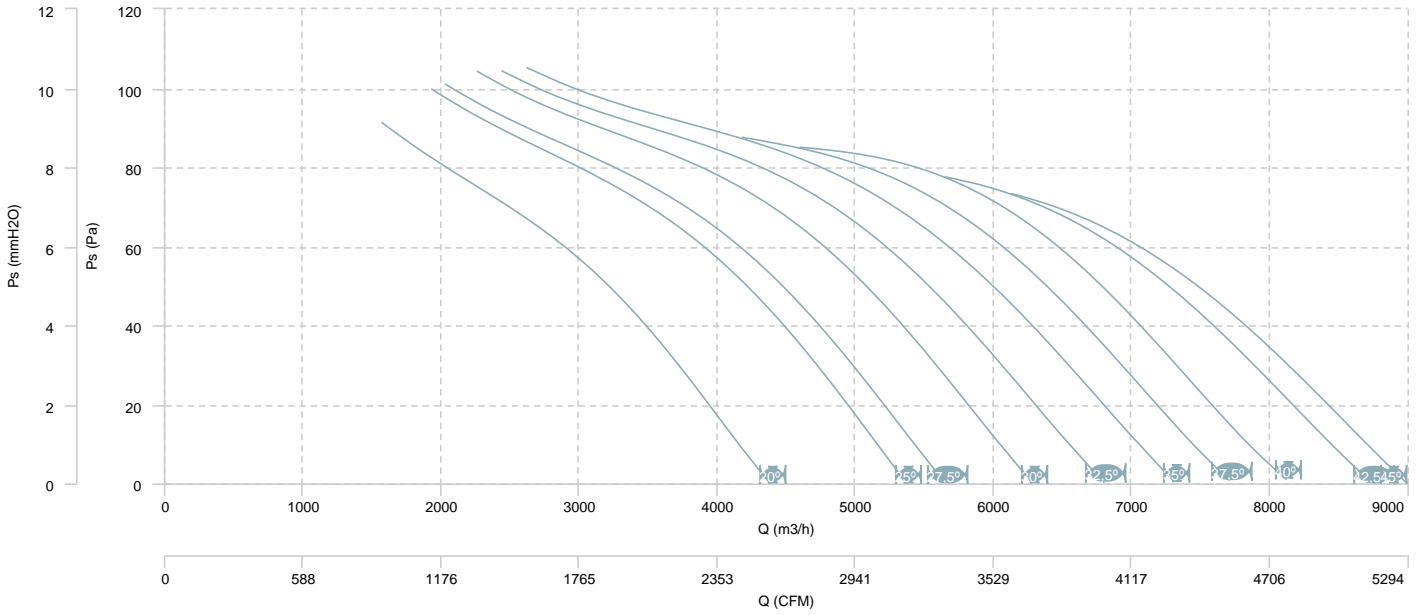

AIR FLOW - MECHANICAL POWER

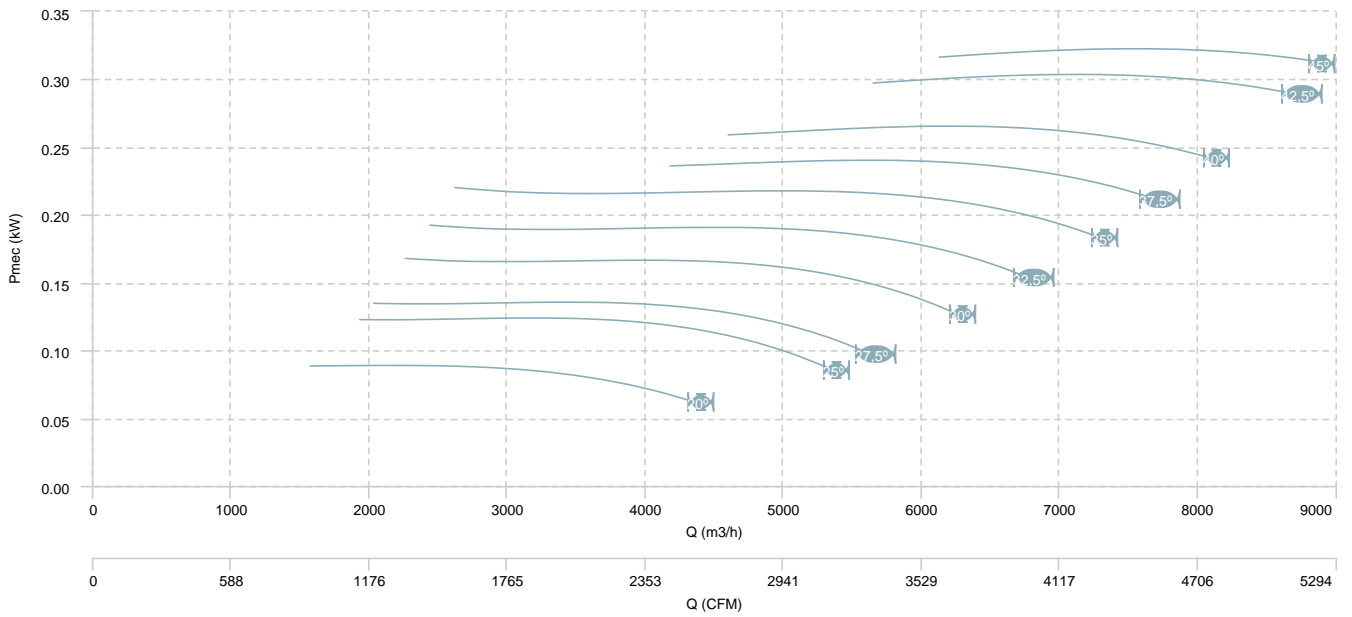

HB 56 T6 (A2:9)

AIR FLOW - PRESSURE

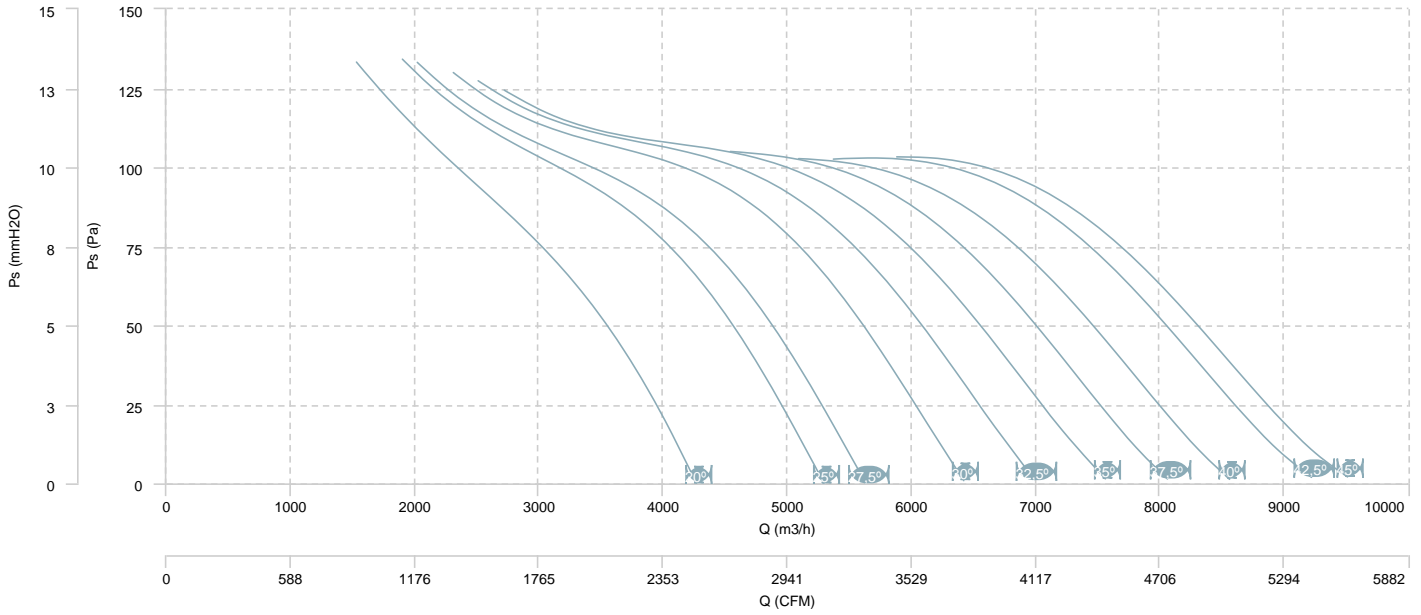

AIR FLOW - MECHANICAL POWER

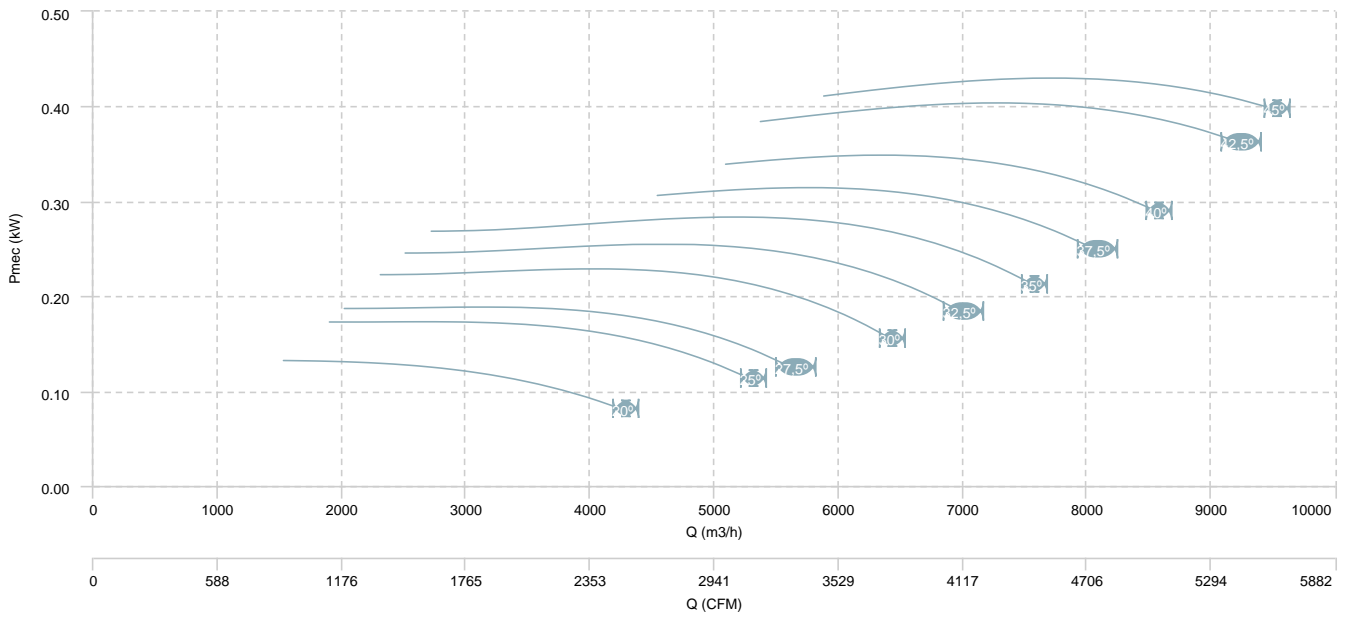

HB 56 T6 (A5:6)

AIR FLOW - PRESSURE

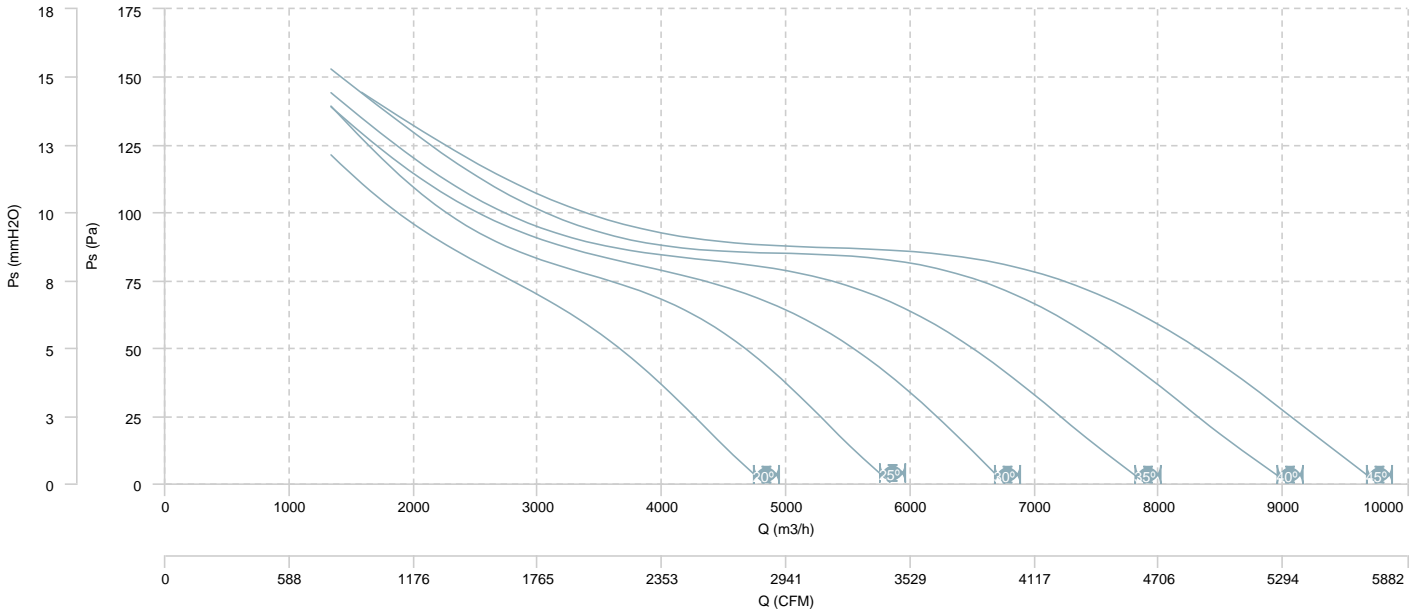

AIR FLOW - MECHANICAL POWER

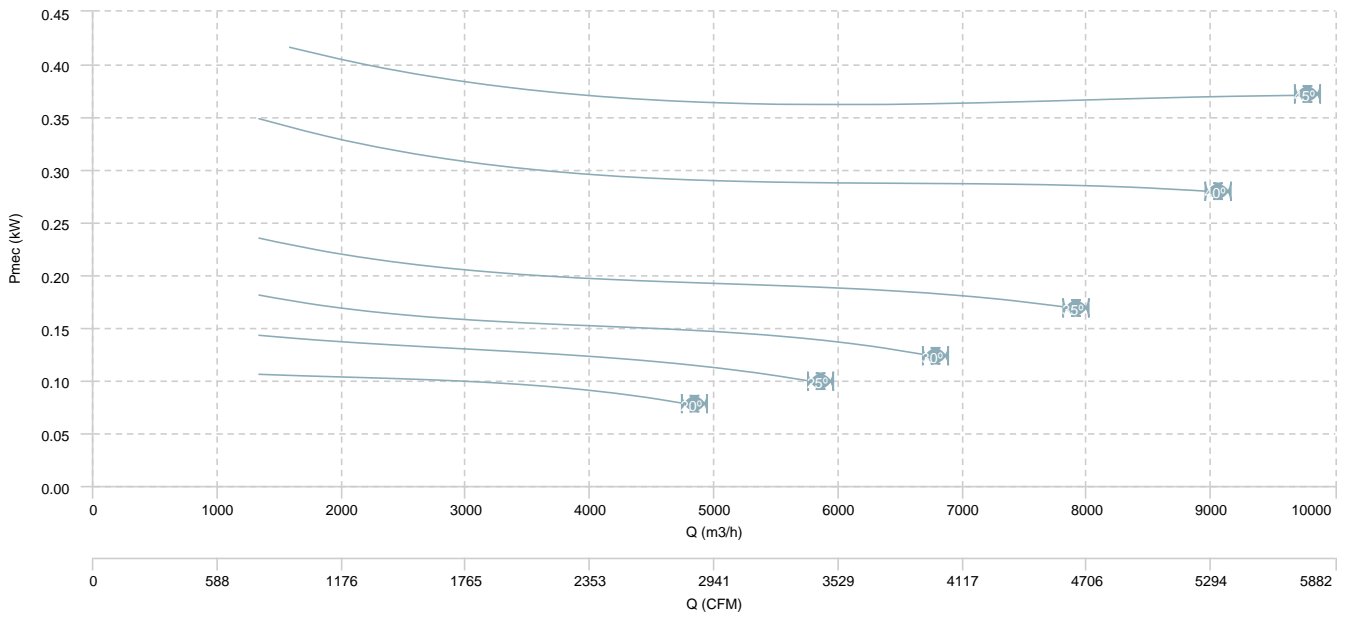

HB 56 T4/T8 (A5:6)

AIR FLOW - PRESSURE (4 poles)

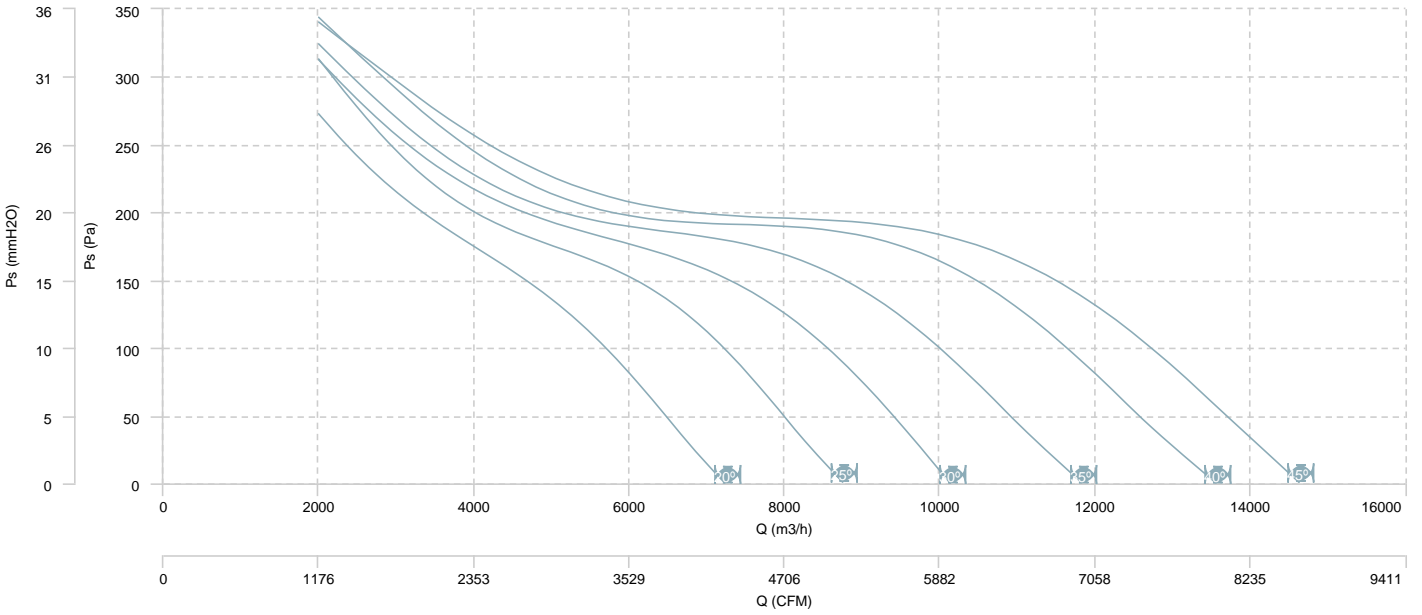

AIR FLOW - MECHANICAL POWER (4 poles)

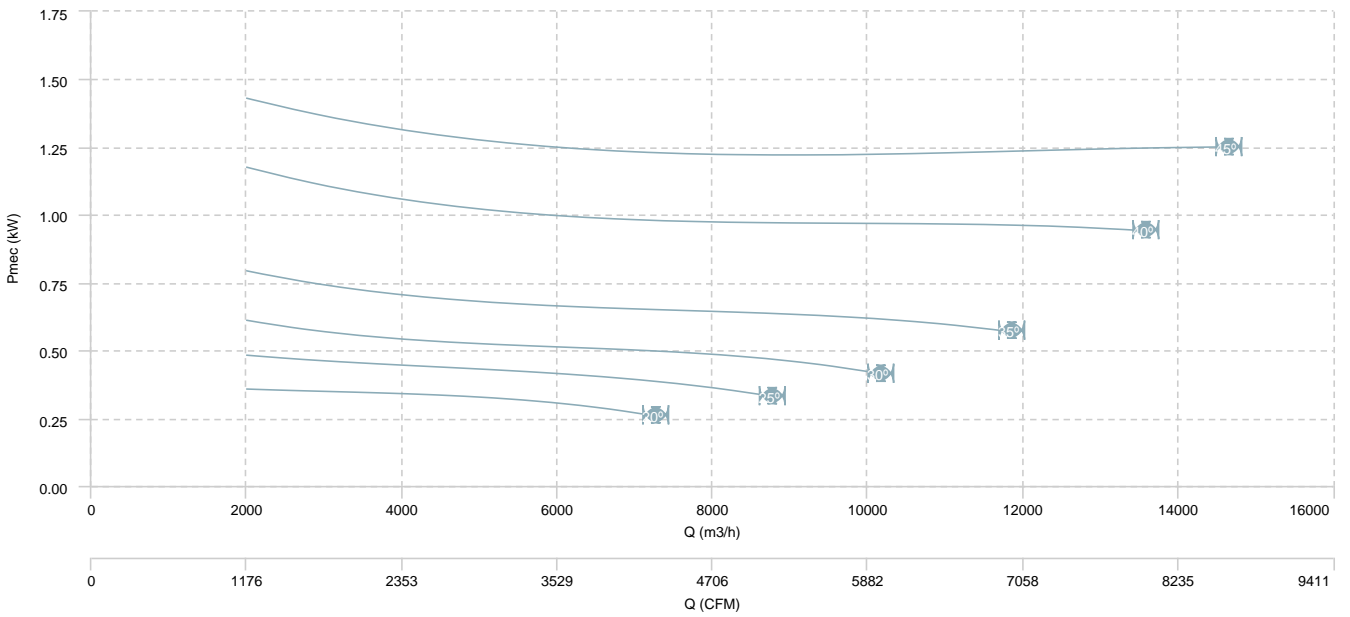

HB 56 T4/T8 (A5:6)

AIR FLOW - PRESSURE (8 poles)

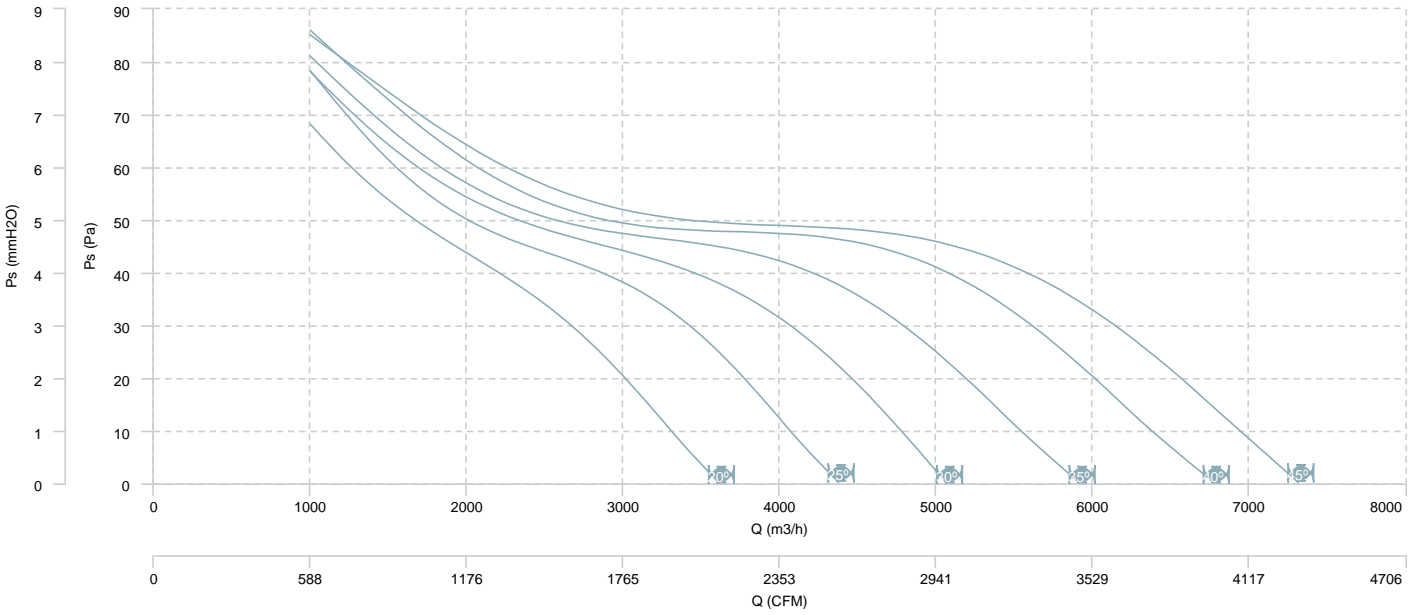

AIR FLOW - MECHANICAL POWER (8 poles)

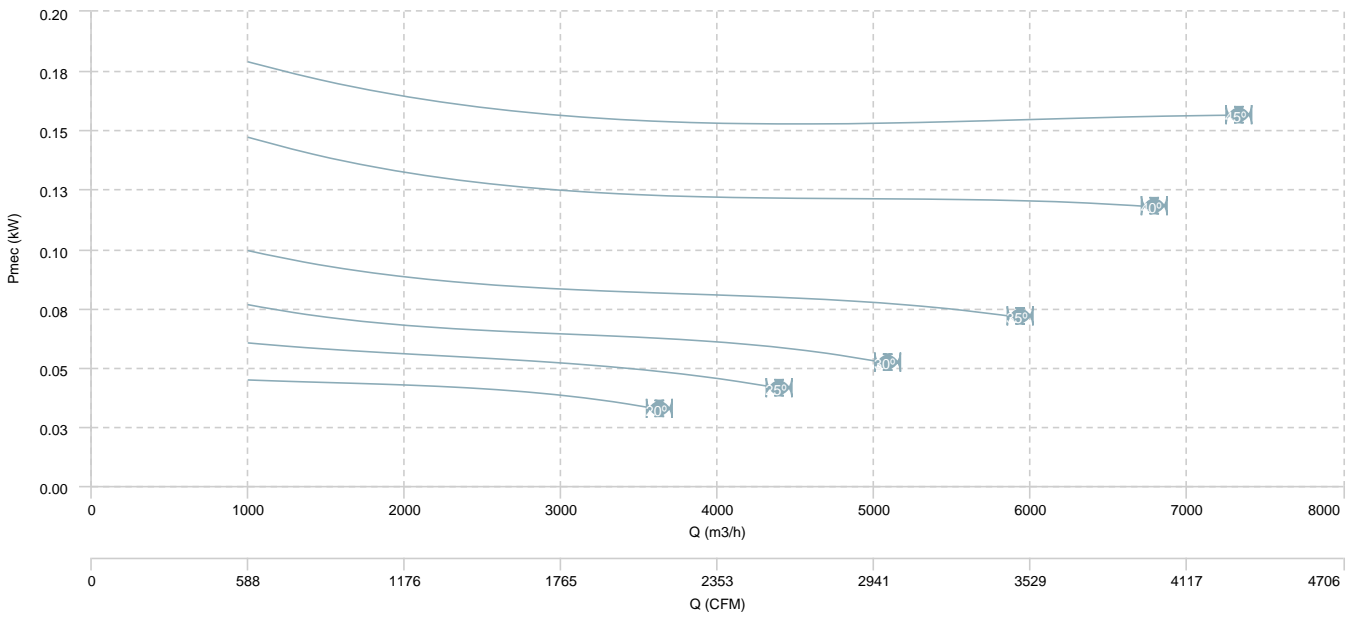

HB 56 T4/T8 (A2:9)

AIR FLOW - PRESSURE (4 poles)

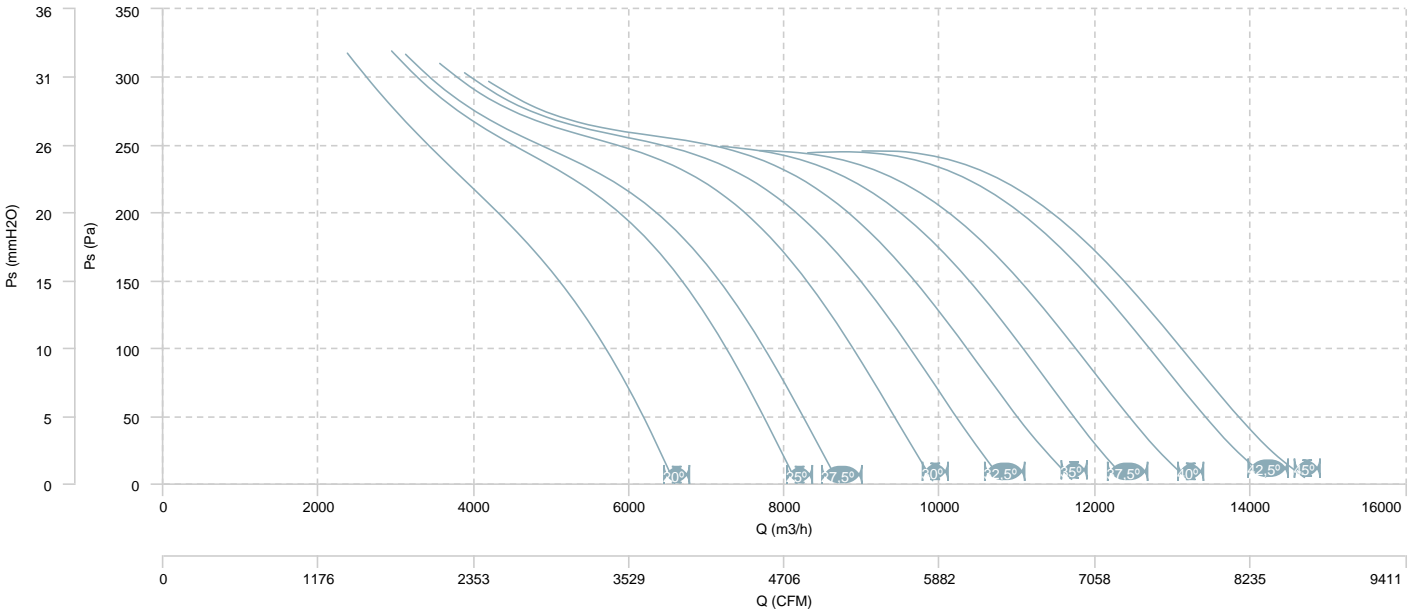

AIR FLOW - MECHANICAL POWER (4 poles)

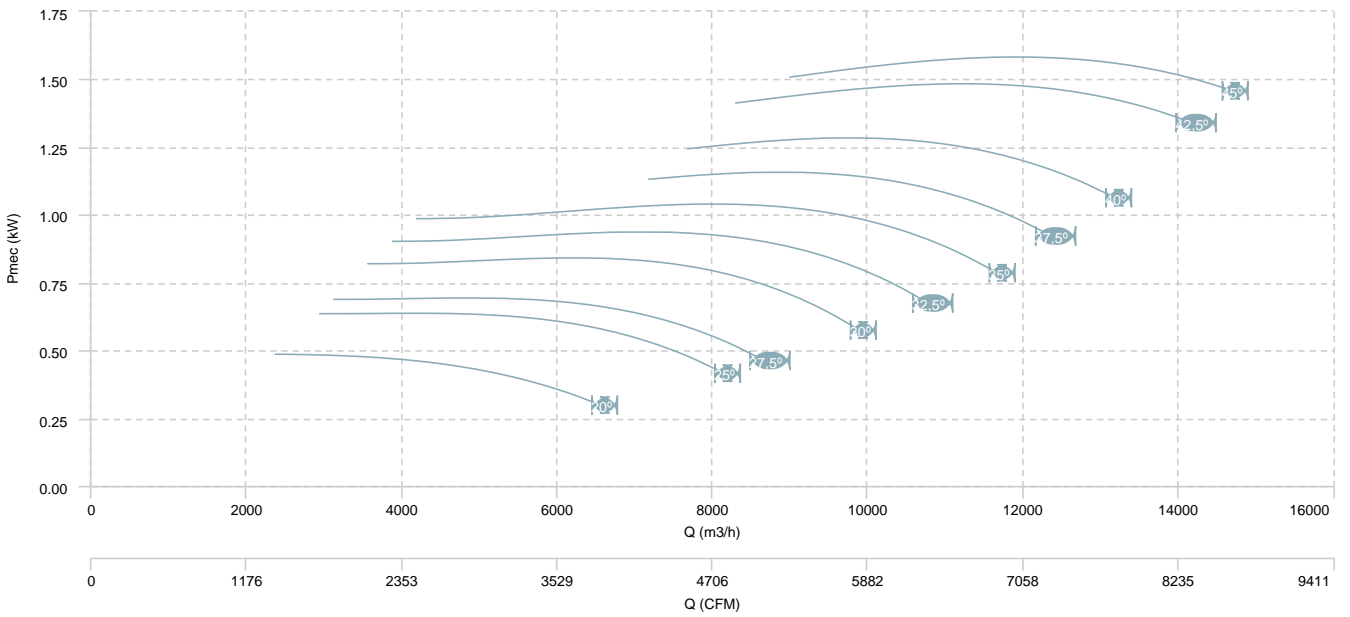

HB 56 T4/T8 (A2:9)

AIR FLOW - PRESSURE (8 poles)

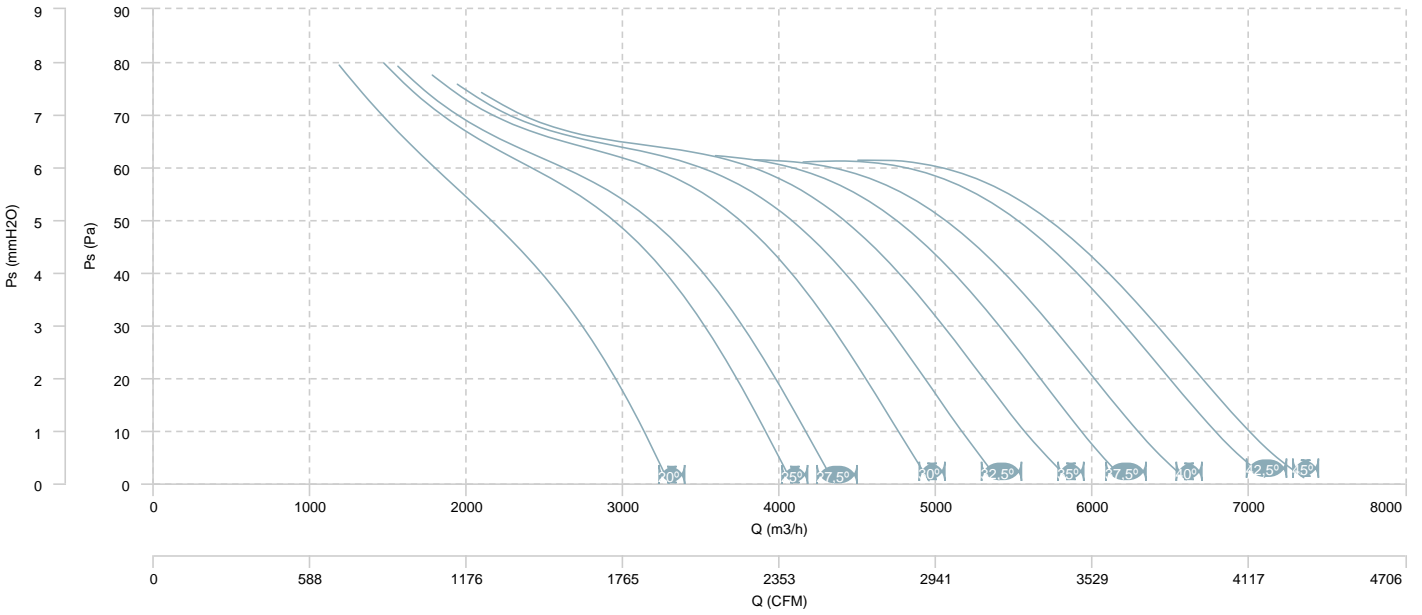

AIR FLOW - MECHANICAL POWER (8 poles)

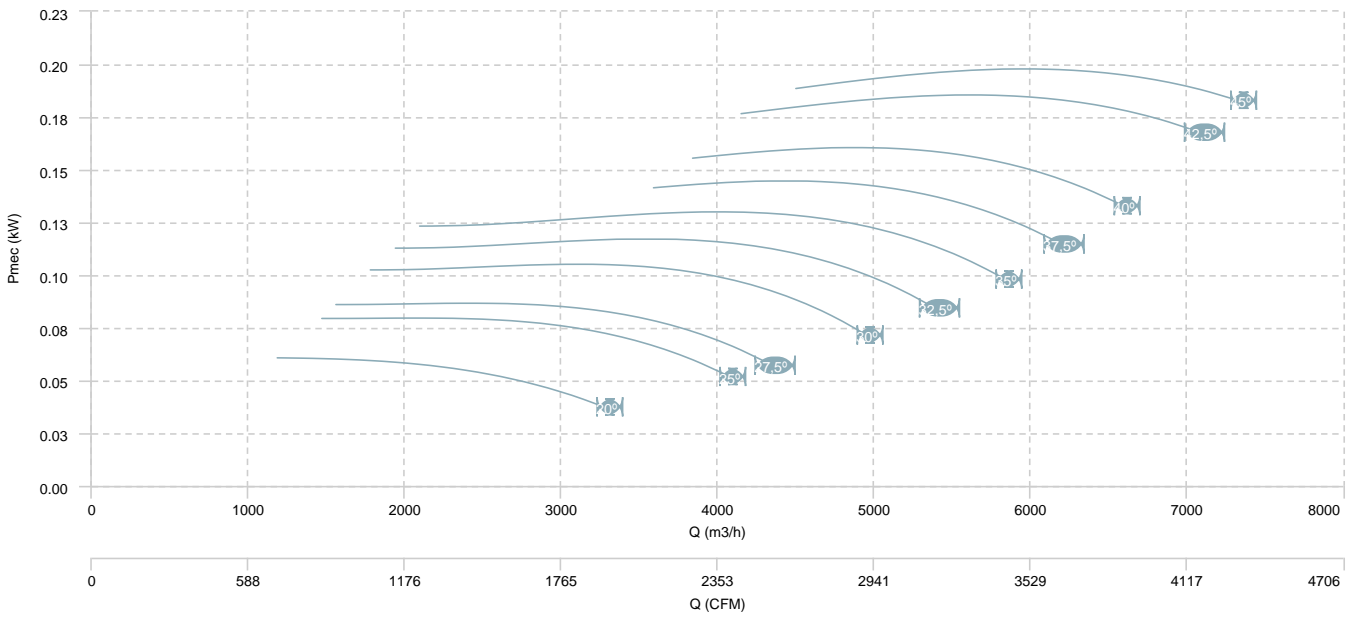

HB 56 T4/T8 (A2:6)

AIR FLOW - PRESSURE (4 poles)

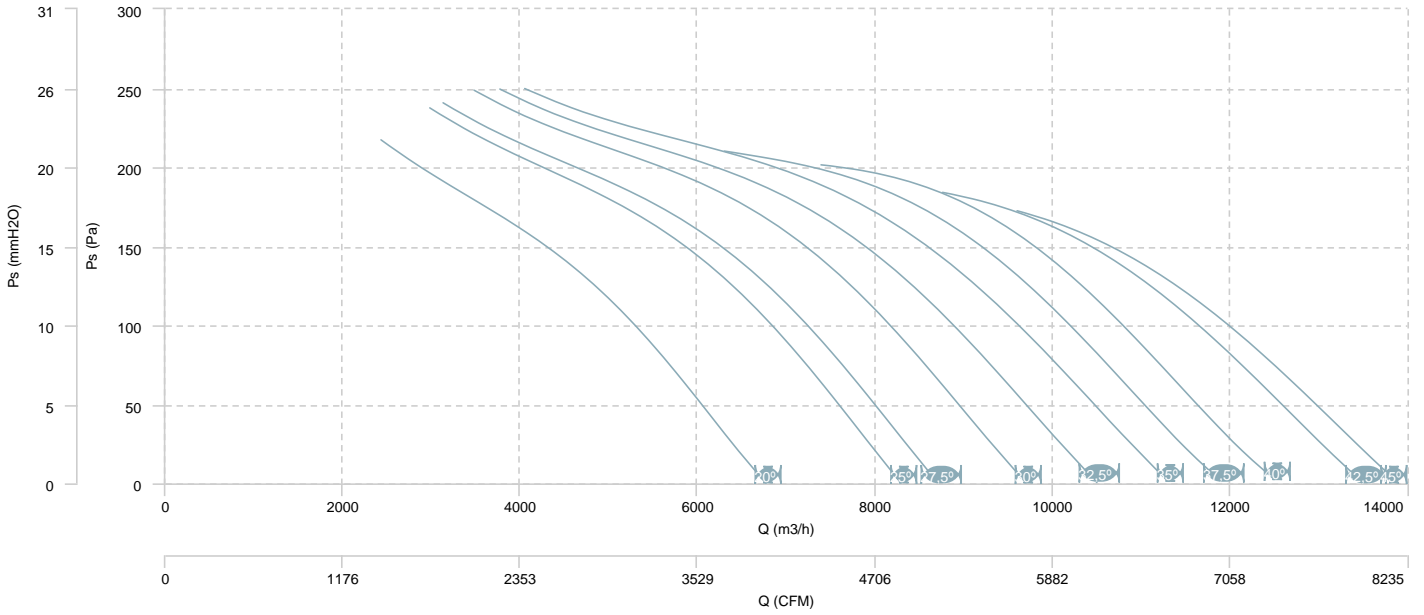

AIR FLOW - MECHANICAL POWER (4 poles)

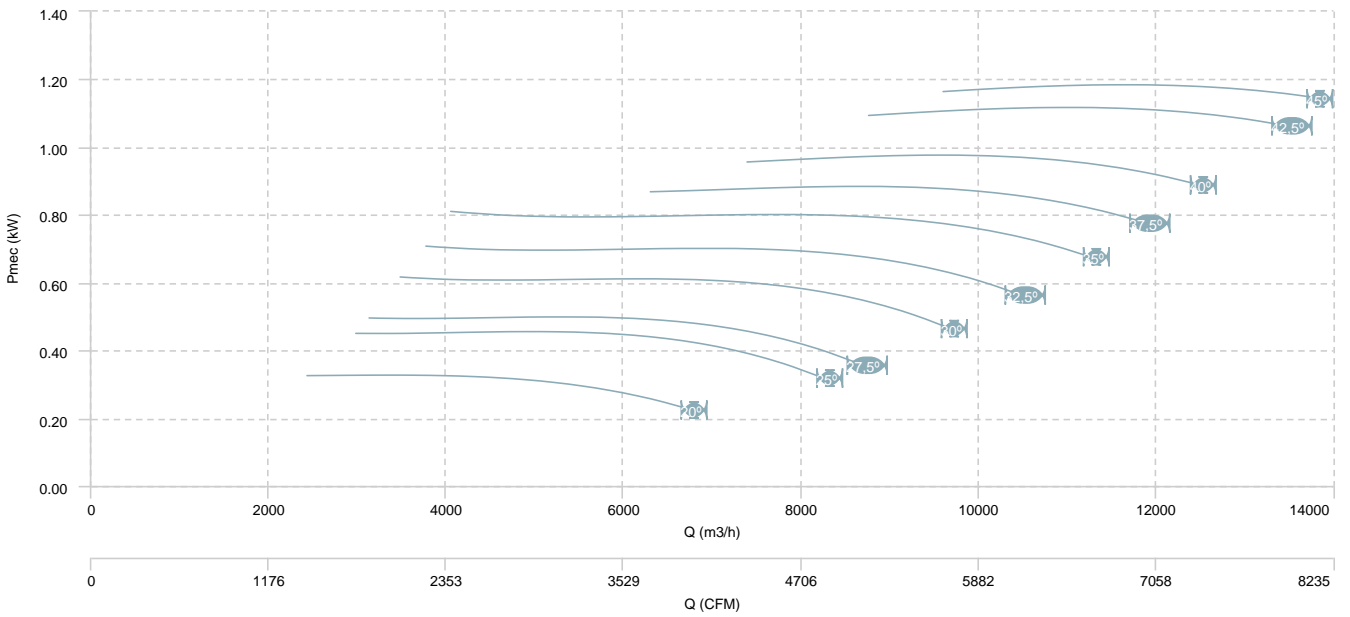

HB 56 T4/T8 (A2:6)

AIR FLOW - PRESSURE (8 poles)

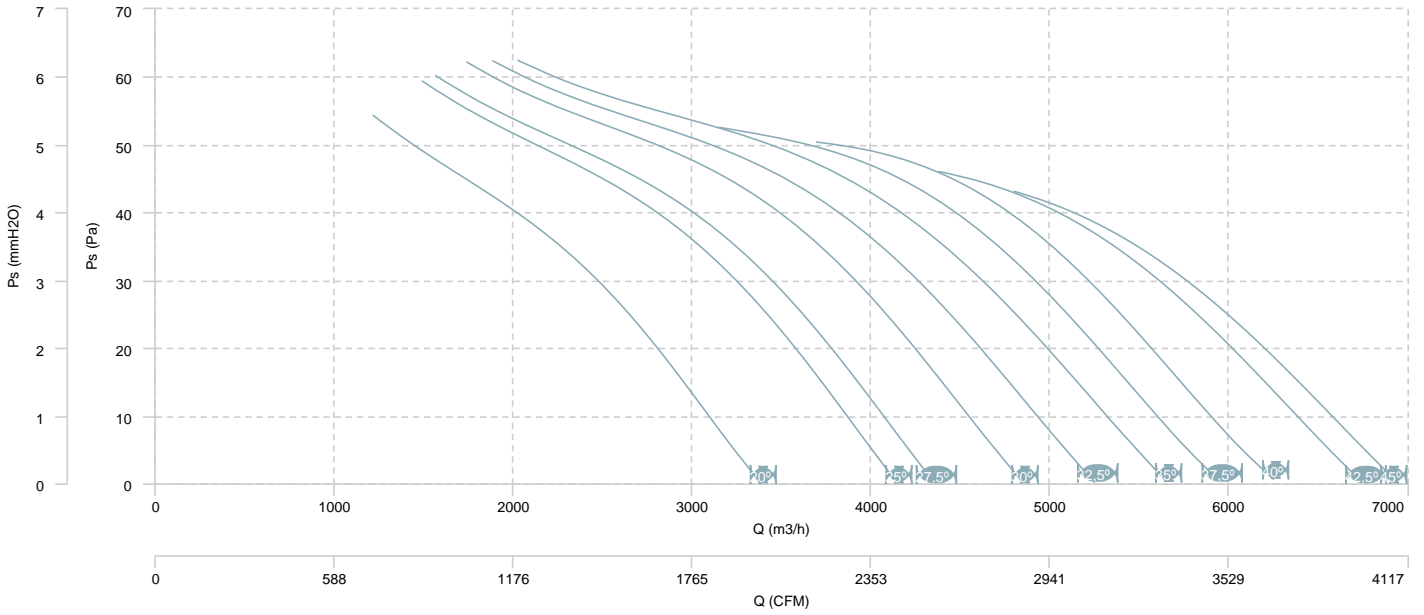

AIR FLOW - MECHANICAL POWER (8 poles)

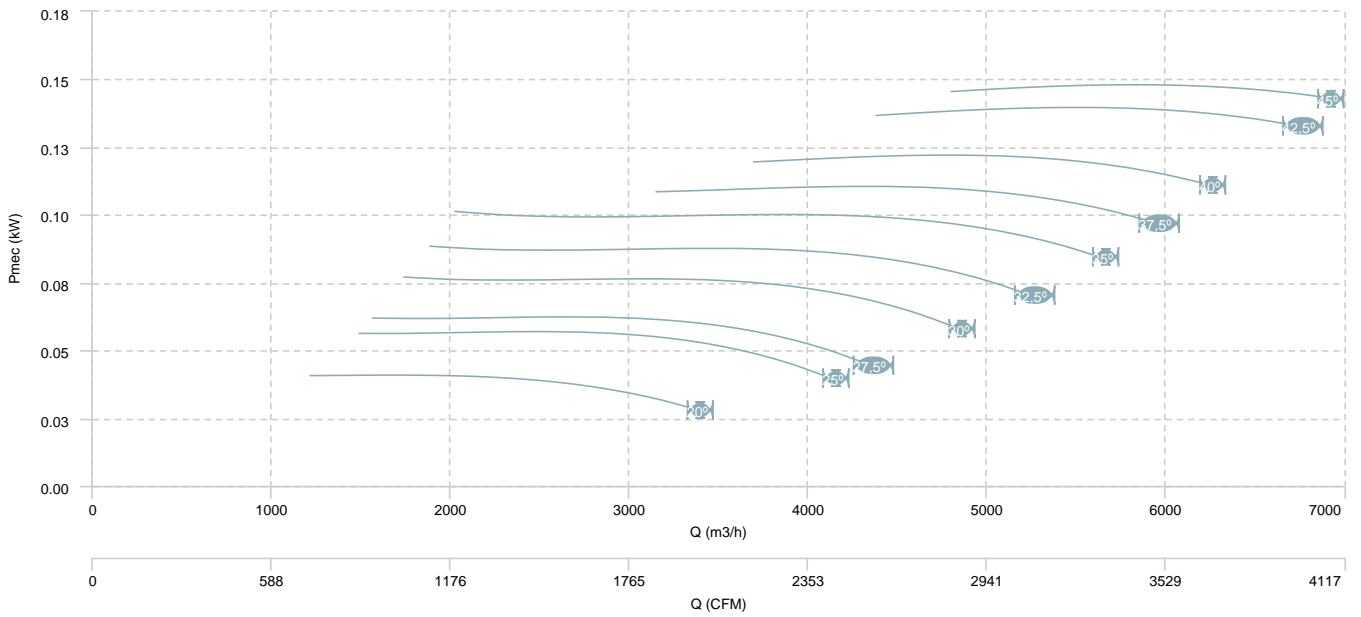

HB 63 T4 (A2:6)

AIR FLOW - PRESSURE

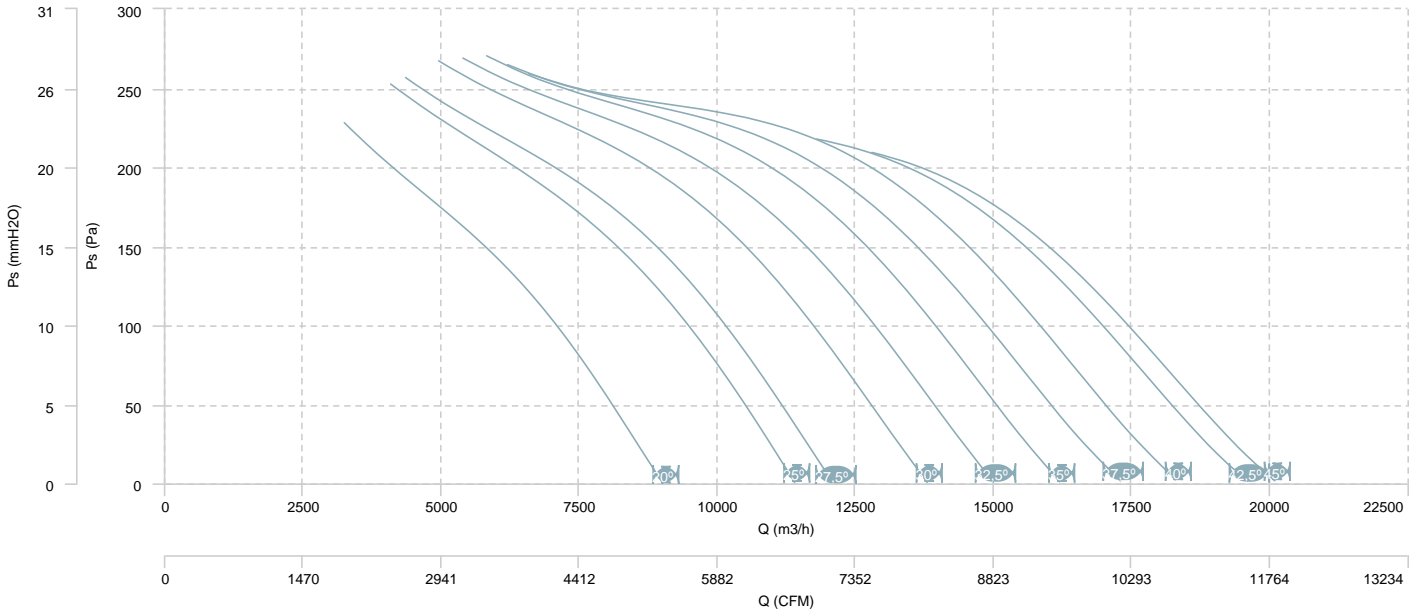

AIR FLOW - MECHANICAL POWER

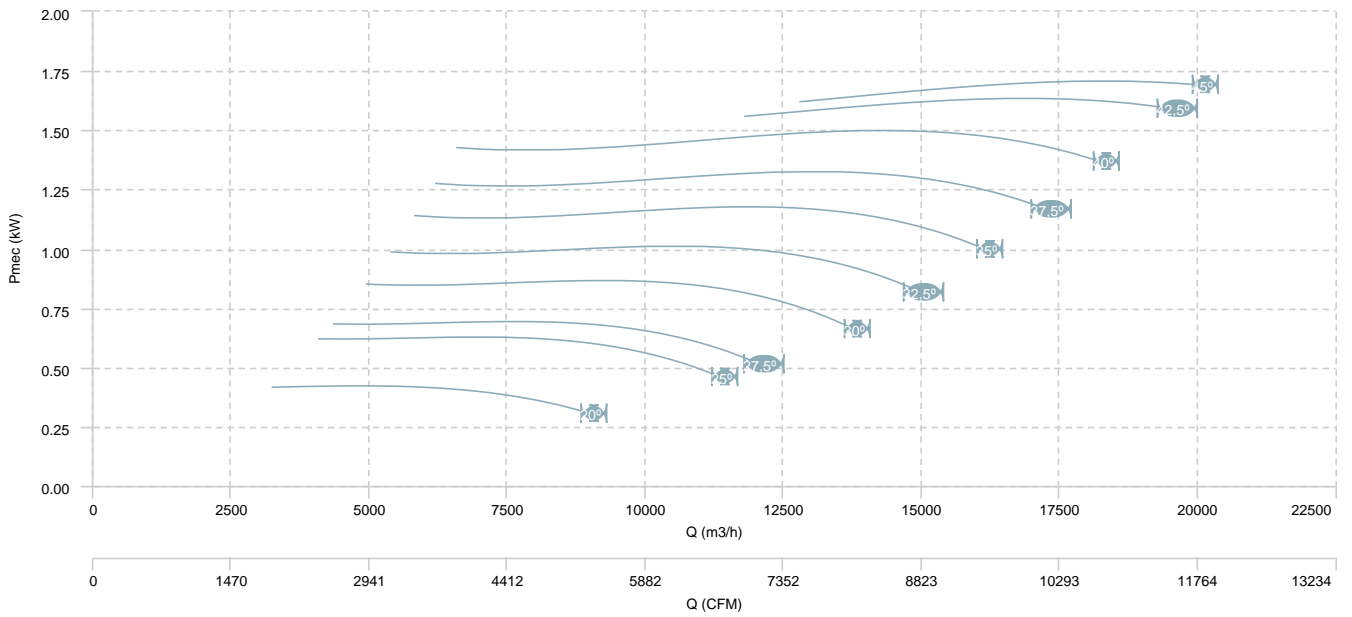

HB 63 T4 (A2:9)

AIR FLOW - PRESSURE

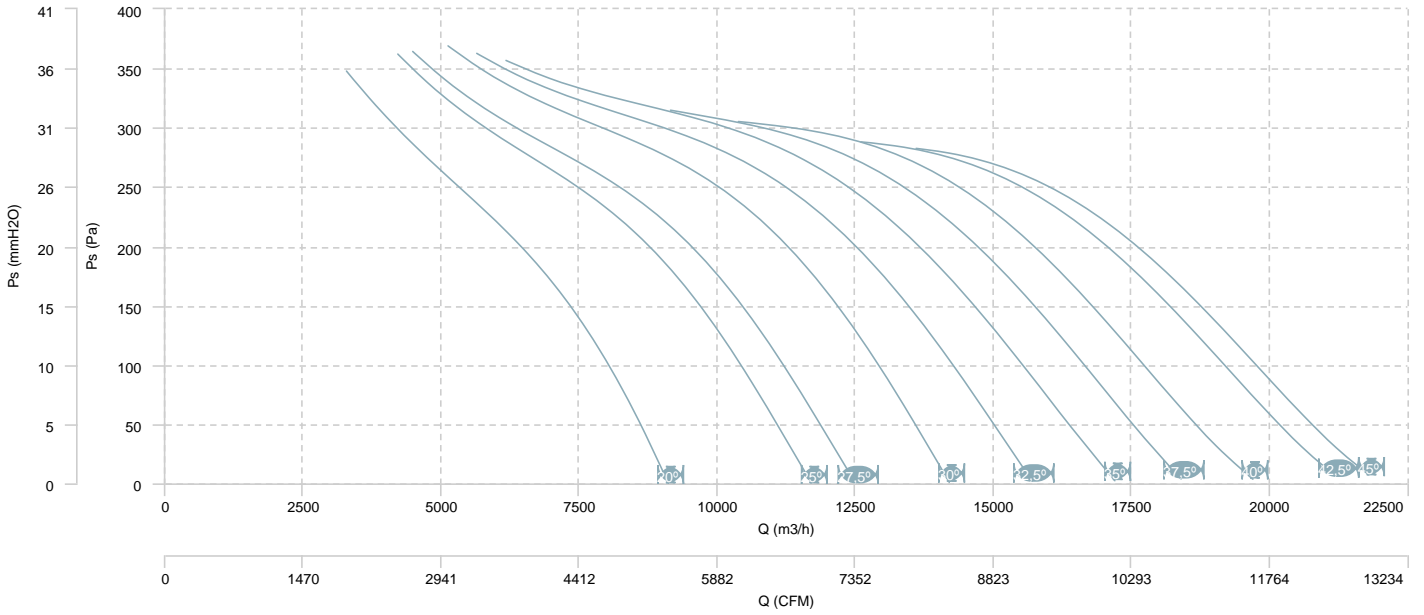

AIR FLOW - MECHANICAL POWER

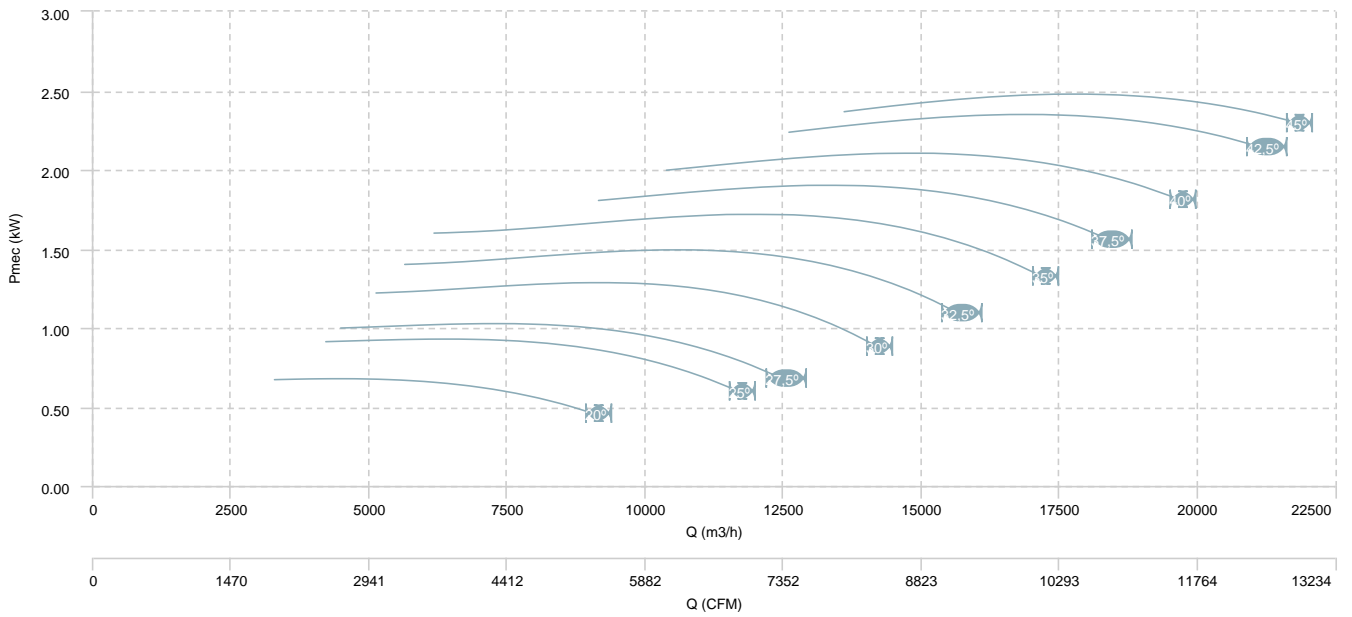

HB 63 T4 (A5:6)

AIR FLOW - PRESSURE

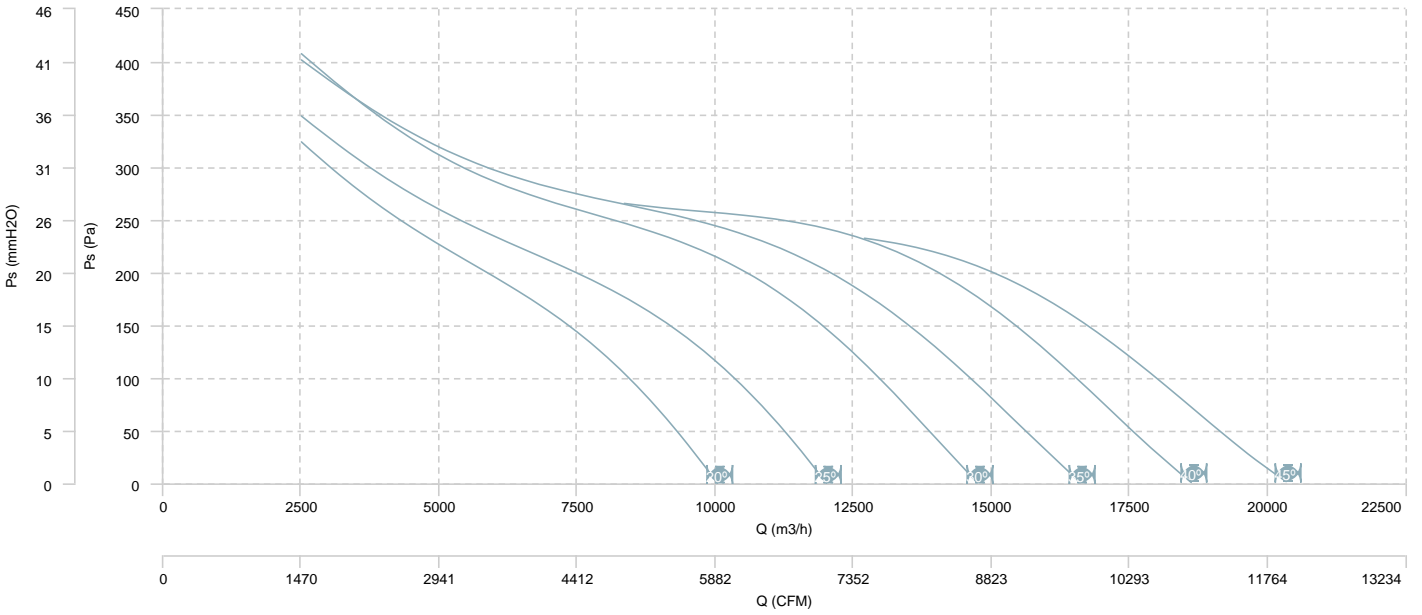

AIR FLOW - MECHANICAL POWER

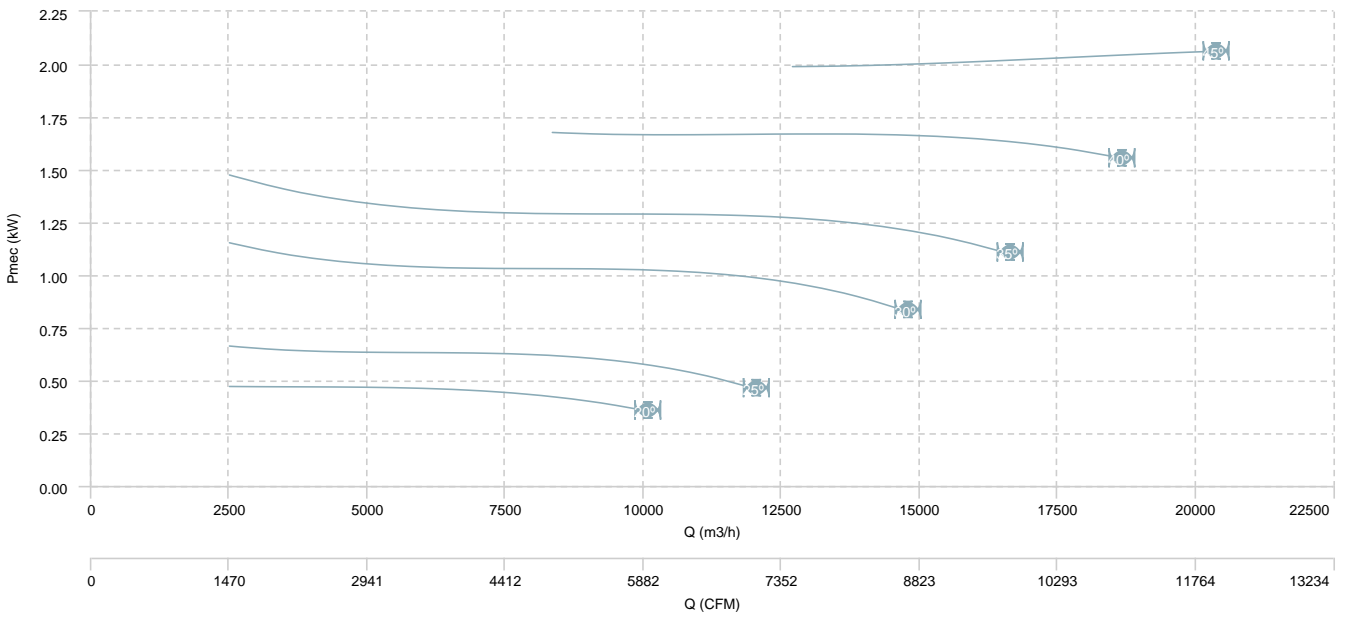

HB 63 T6 (A2:6)

AIR FLOW - PRESSURE

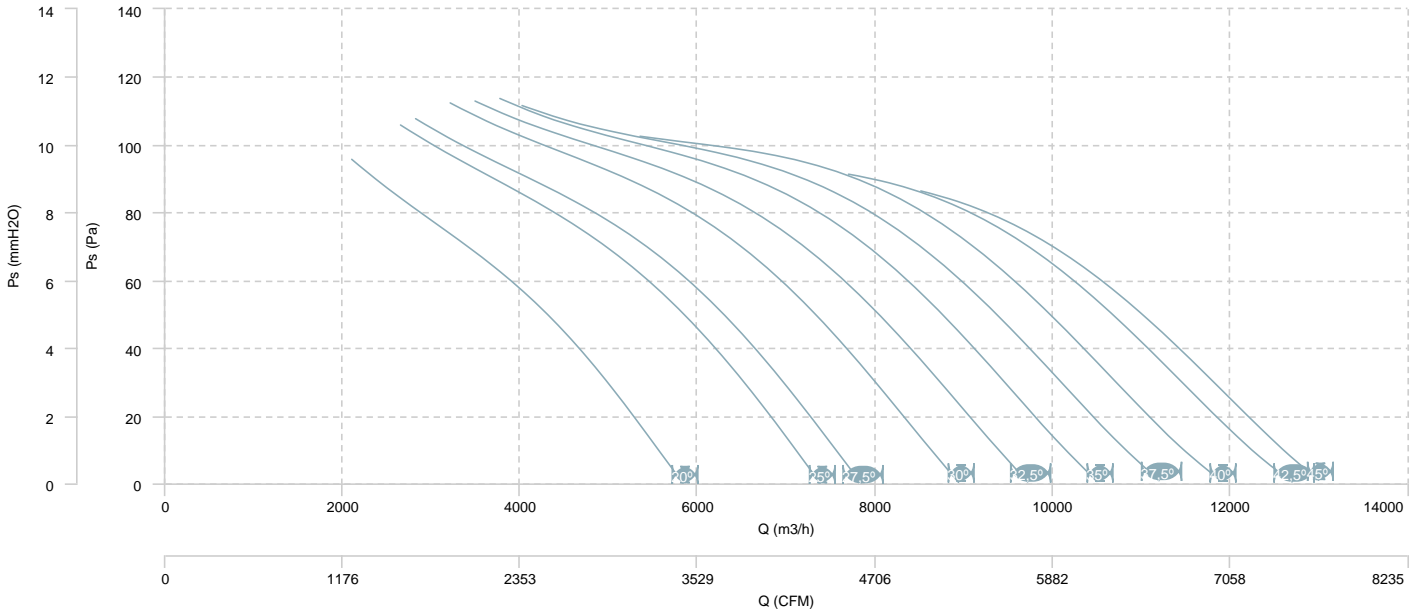

AIR FLOW - MECHANICAL POWER

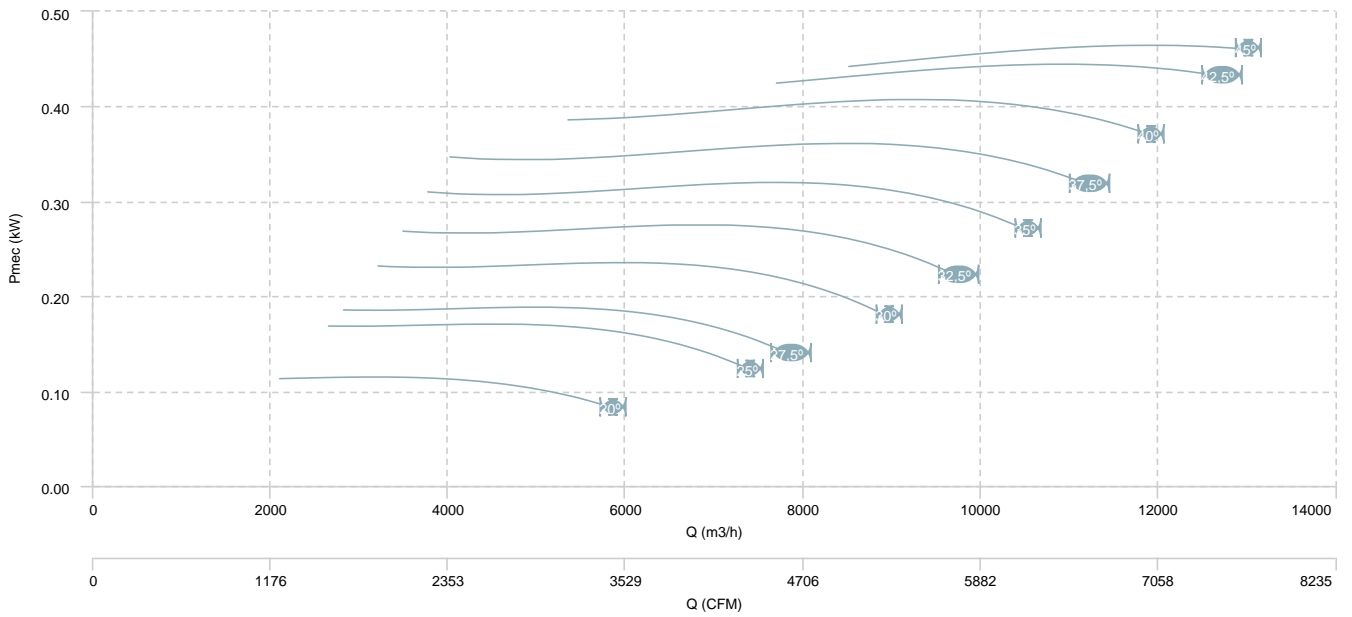

HB 63 T6 (A2:9)

AIR FLOW - PRESSURE

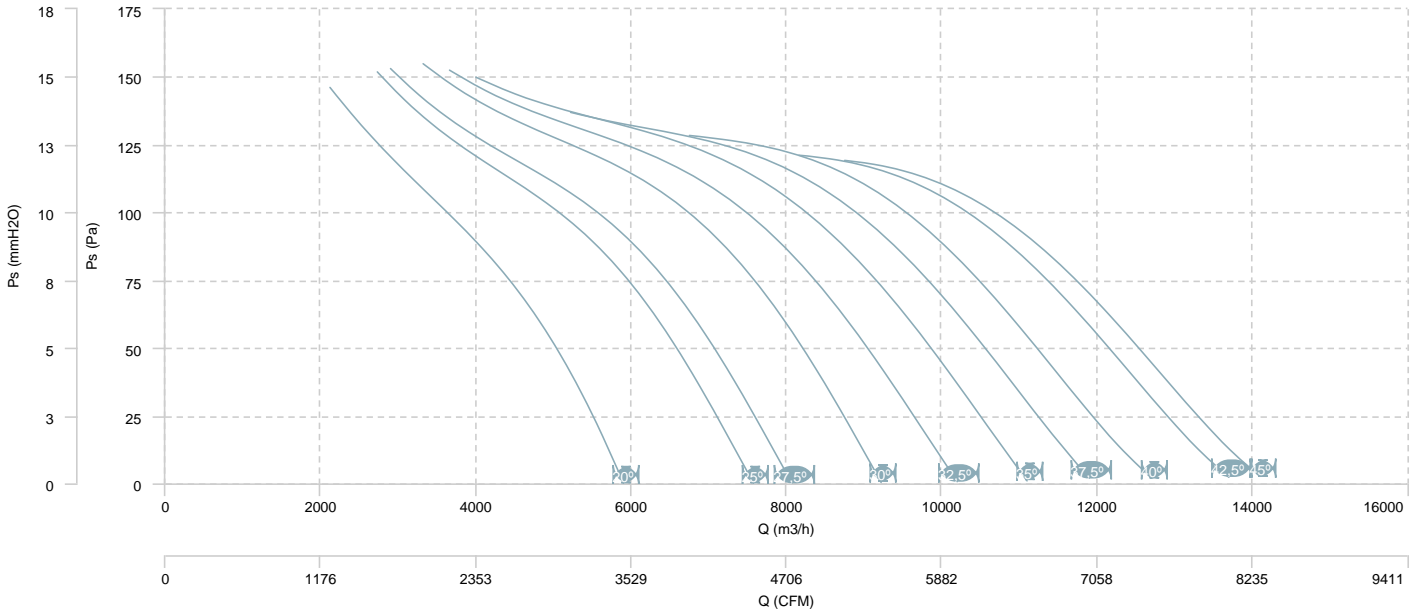

AIR FLOW - MECHANICAL POWER

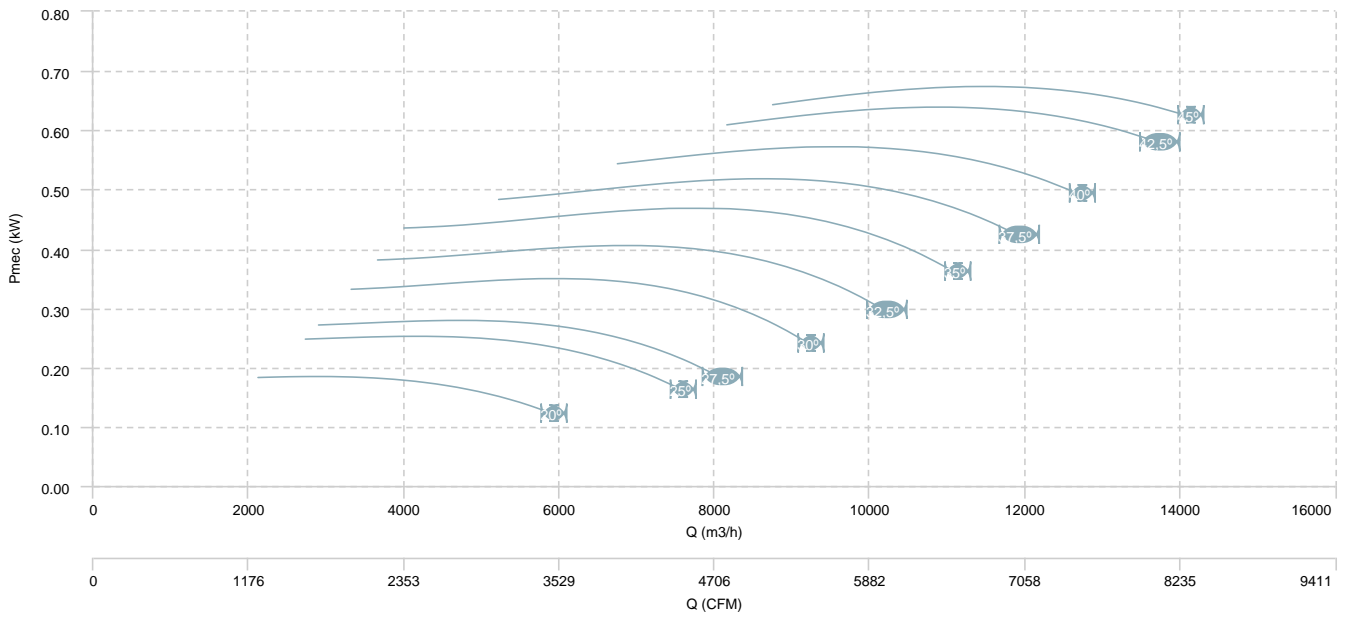

HB 63 T6 (A5:6)

AIR FLOW - PRESSURE

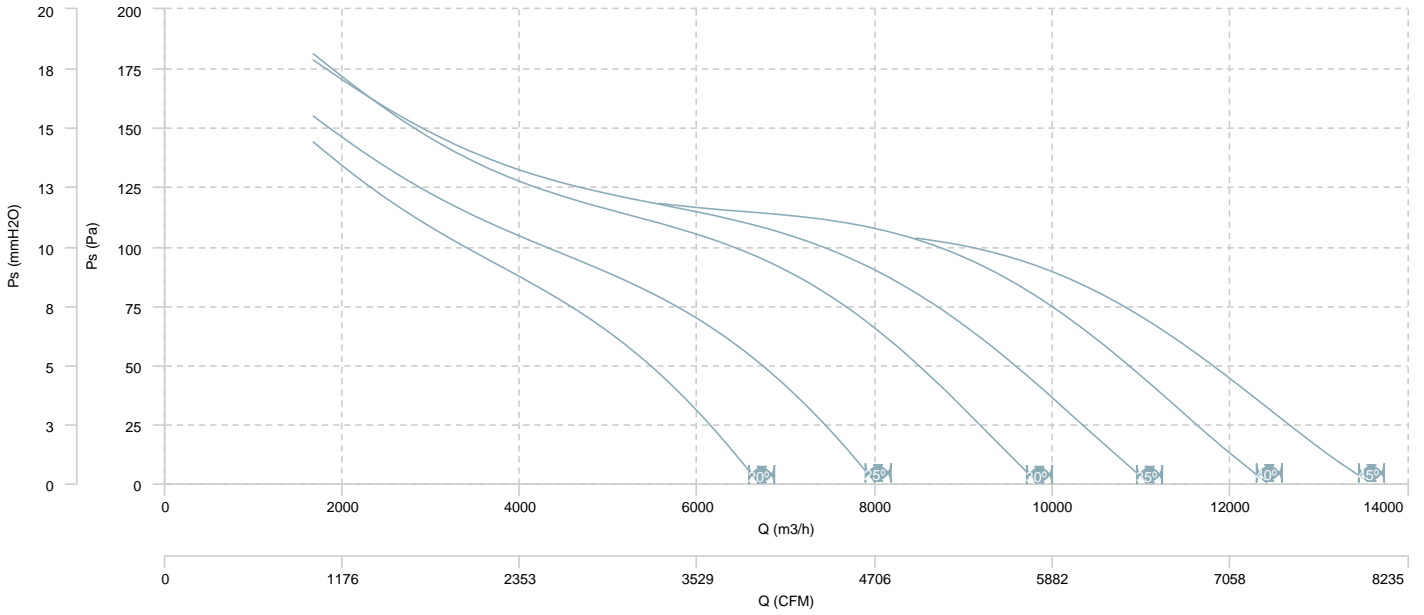

AIR FLOW - MECHANICAL POWER

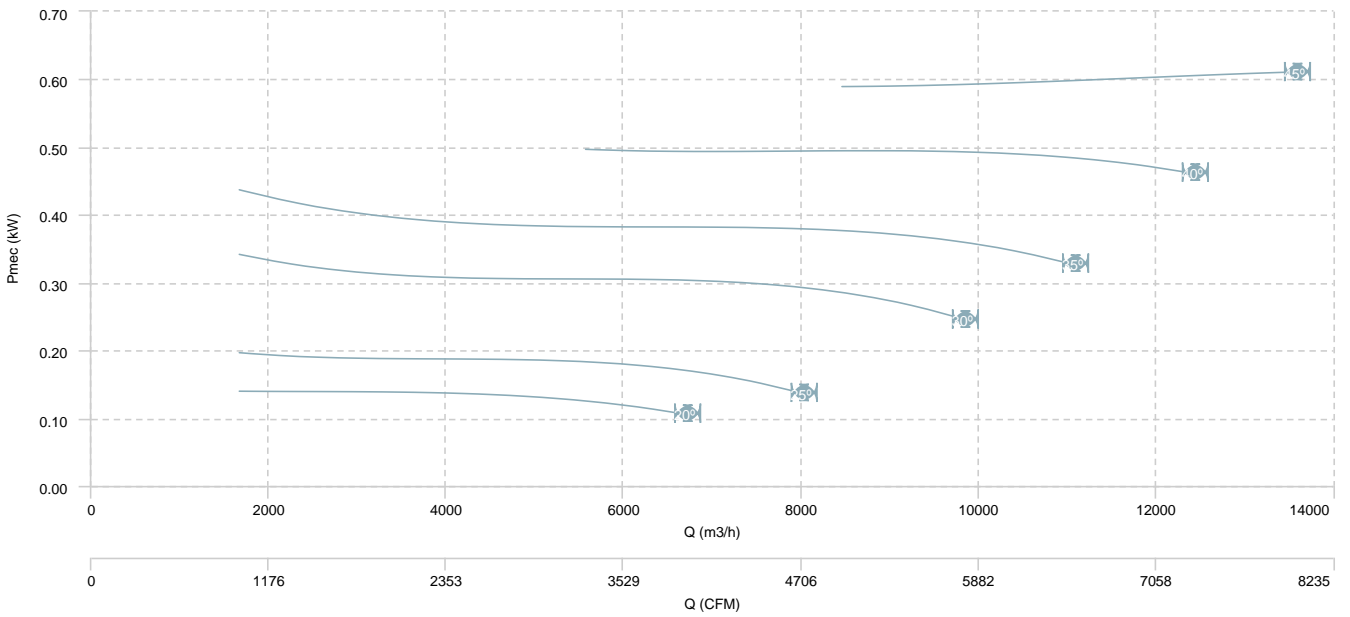

HB 63 T4/T8 (A2:6)

AIR FLOW - PRESSURE (4 poles)

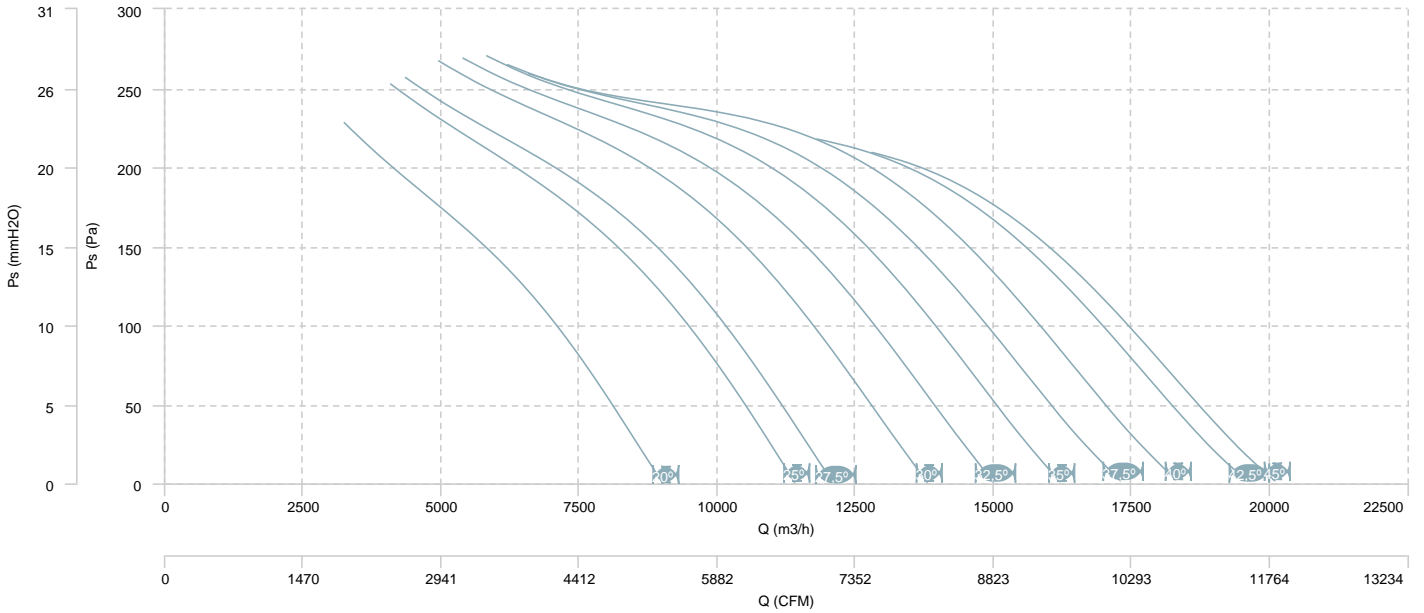

AIR FLOW - MECHANICAL POWER (4 poles)

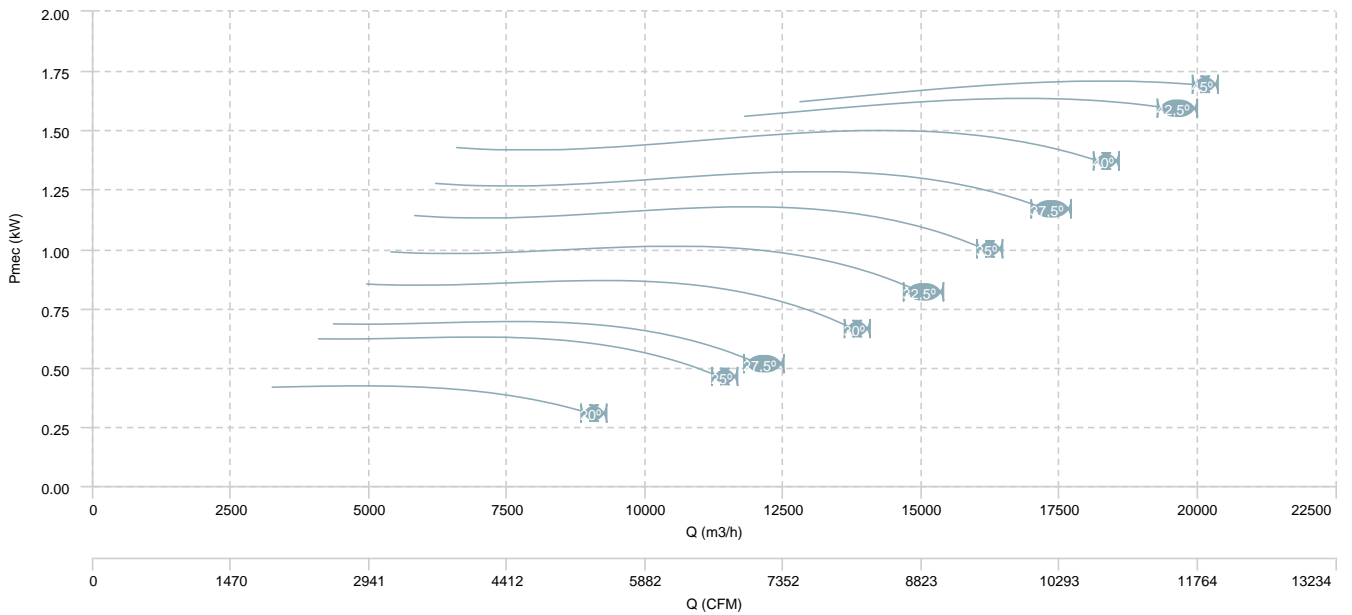

HB 63 T4/T8 (A2:6)

AIR FLOW - PRESSURE (8 poles)

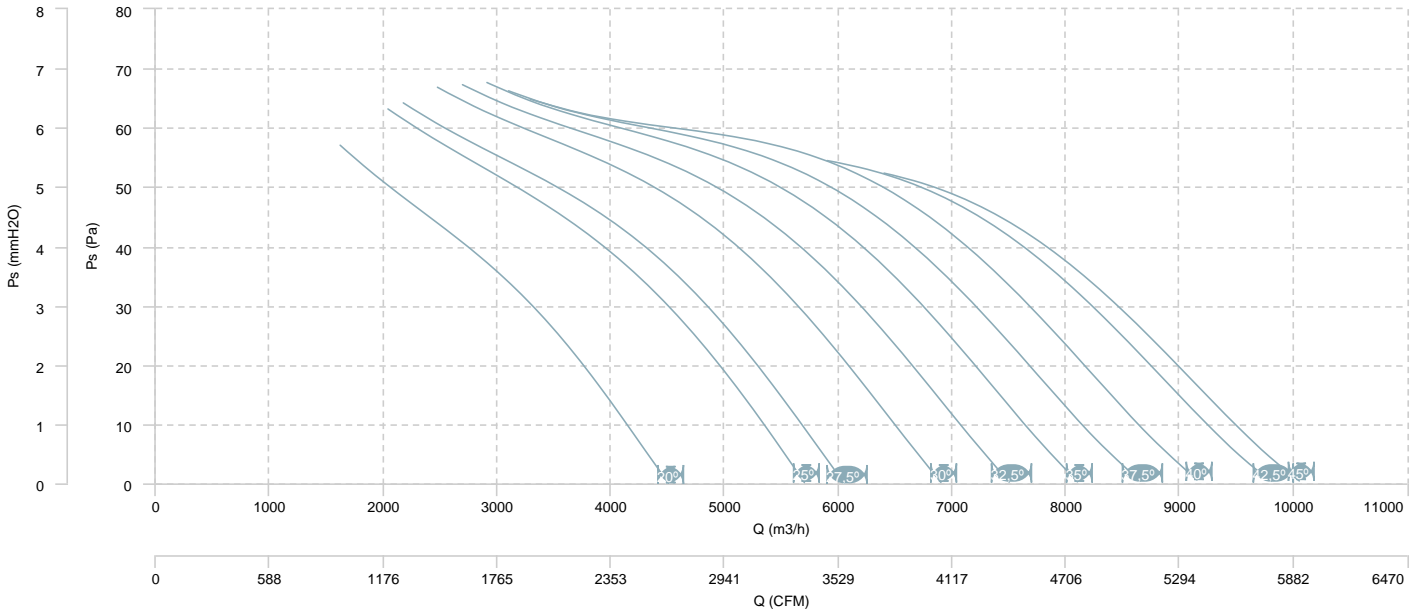

AIR FLOW - MECHANICAL POWER (8 poles)

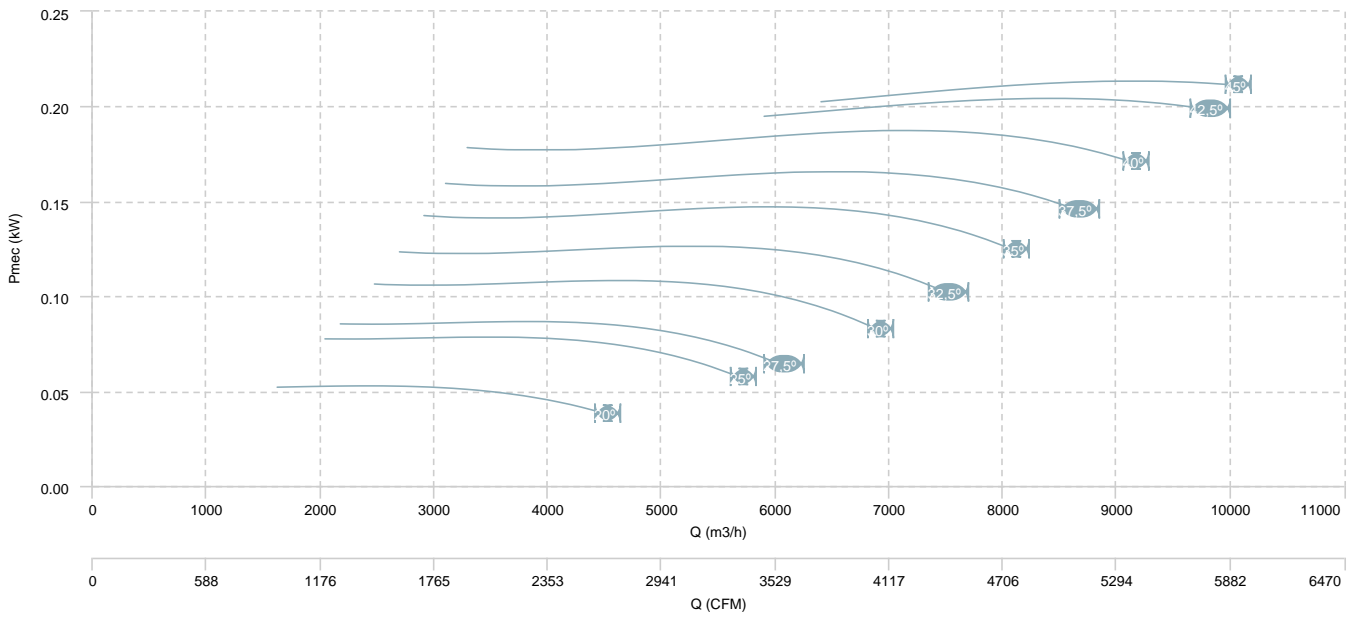

HB 63 T4/T8 (A2:9)

AIR FLOW - PRESSURE (4 poles)

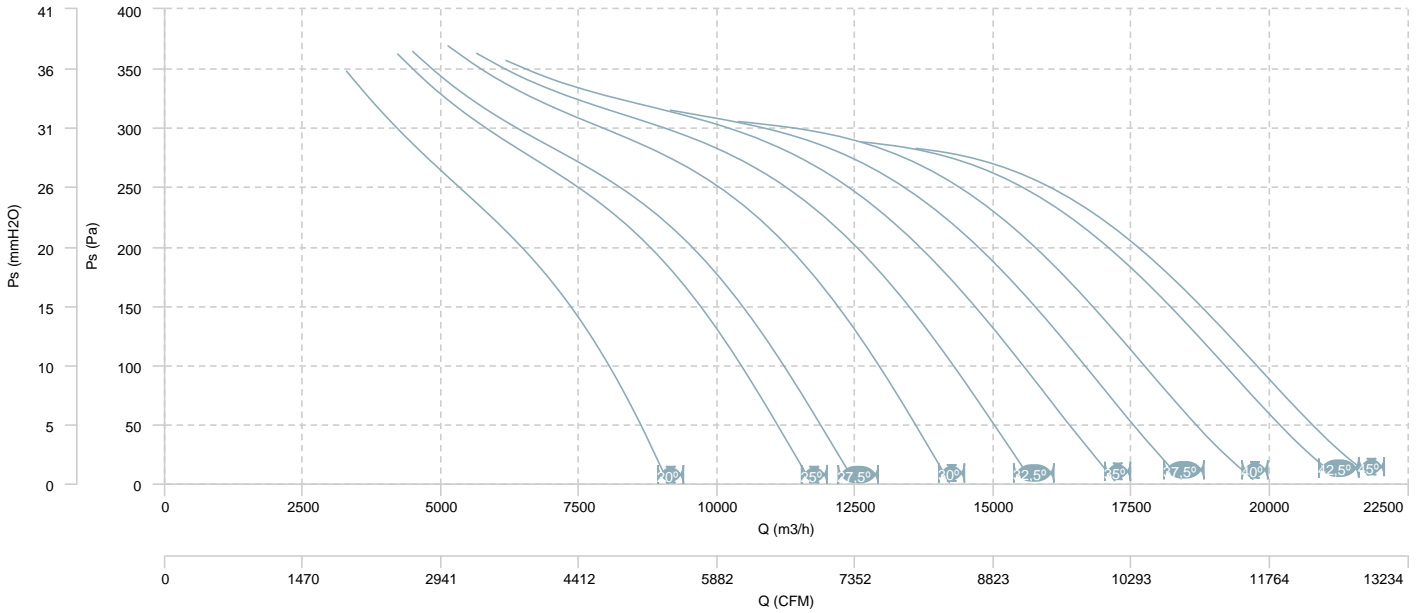

AIR FLOW - MECHANICAL POWER (4 poles)

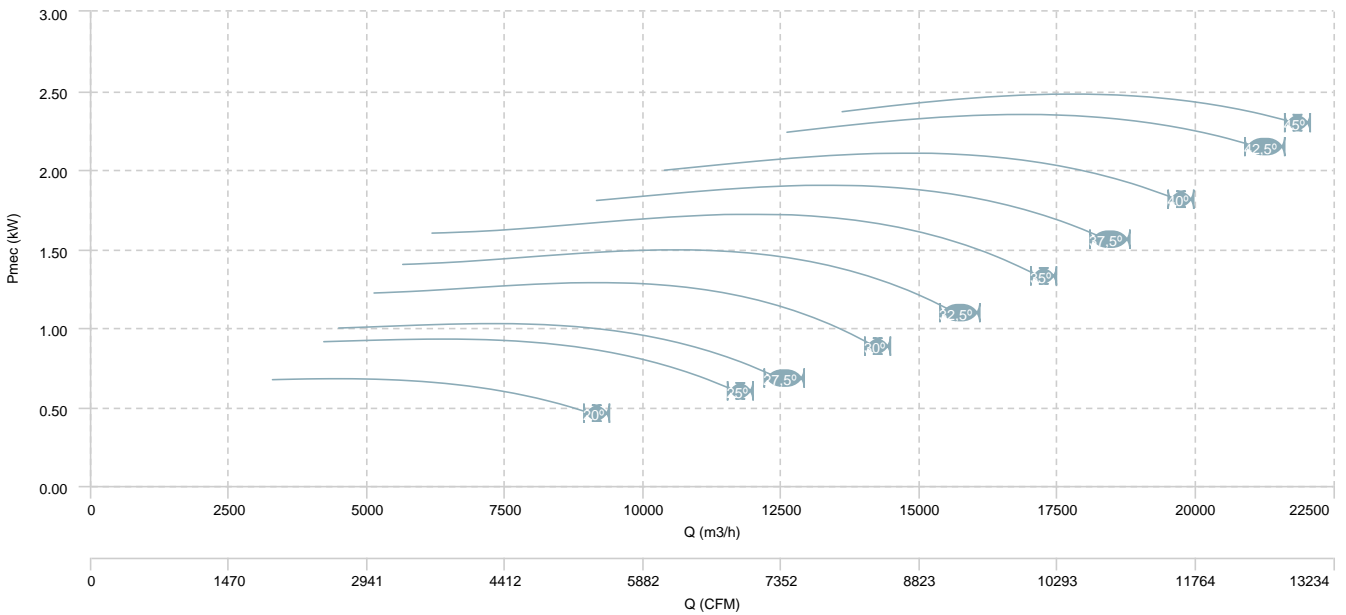

HB 63 T4/T8 (A2:9)

AIR FLOW - PRESSURE (8 poles)

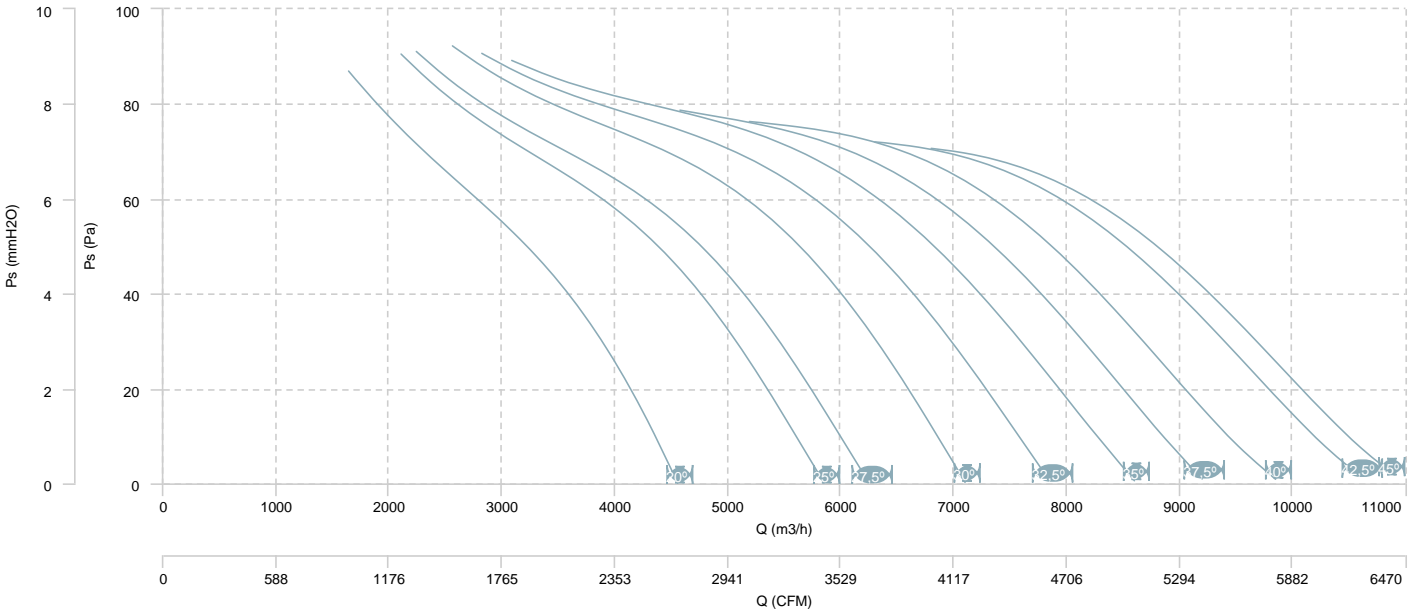

AIR FLOW - MECHANICAL POWER (8 poles)

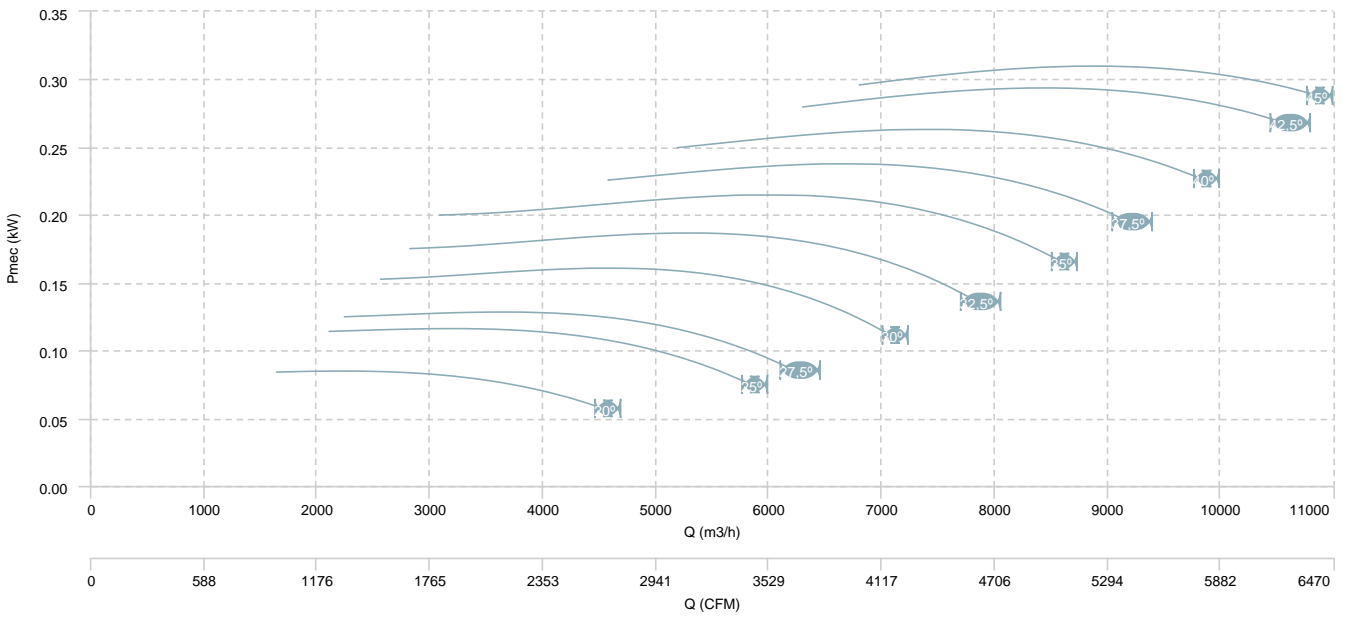

HB 63 T4/T8 (A5:6)

AIR FLOW - PRESSURE (4 poles)

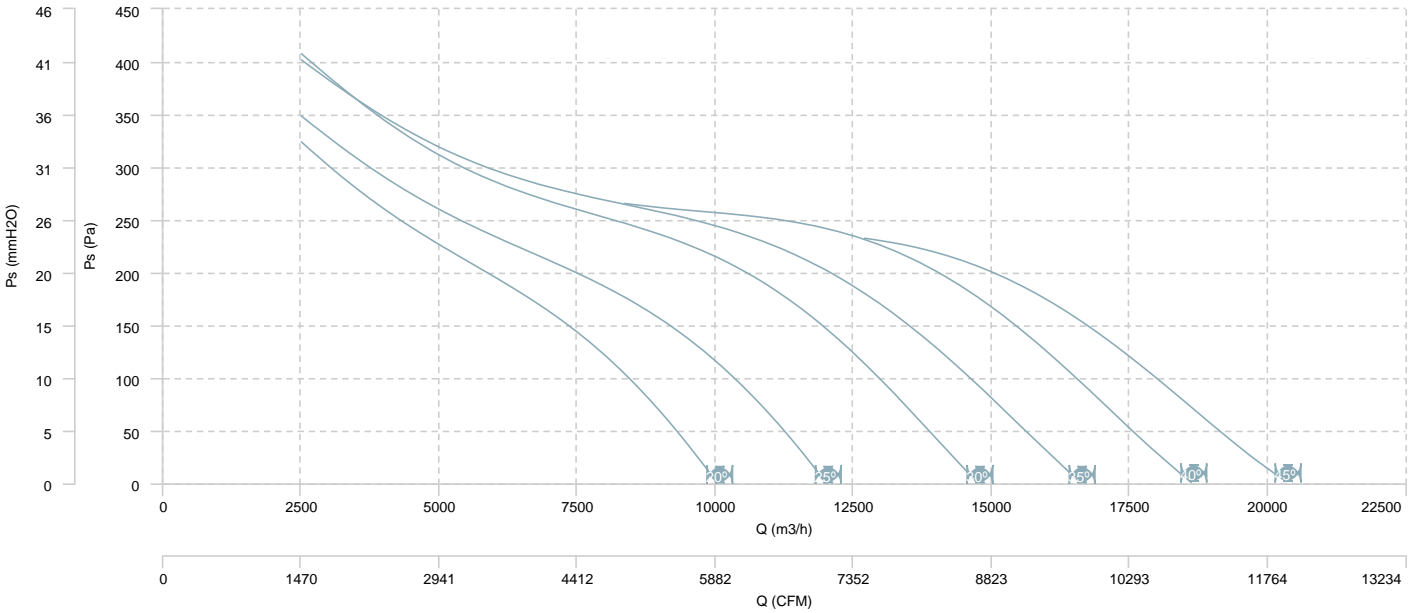

AIR FLOW - MECHANICAL POWER (4 poles)

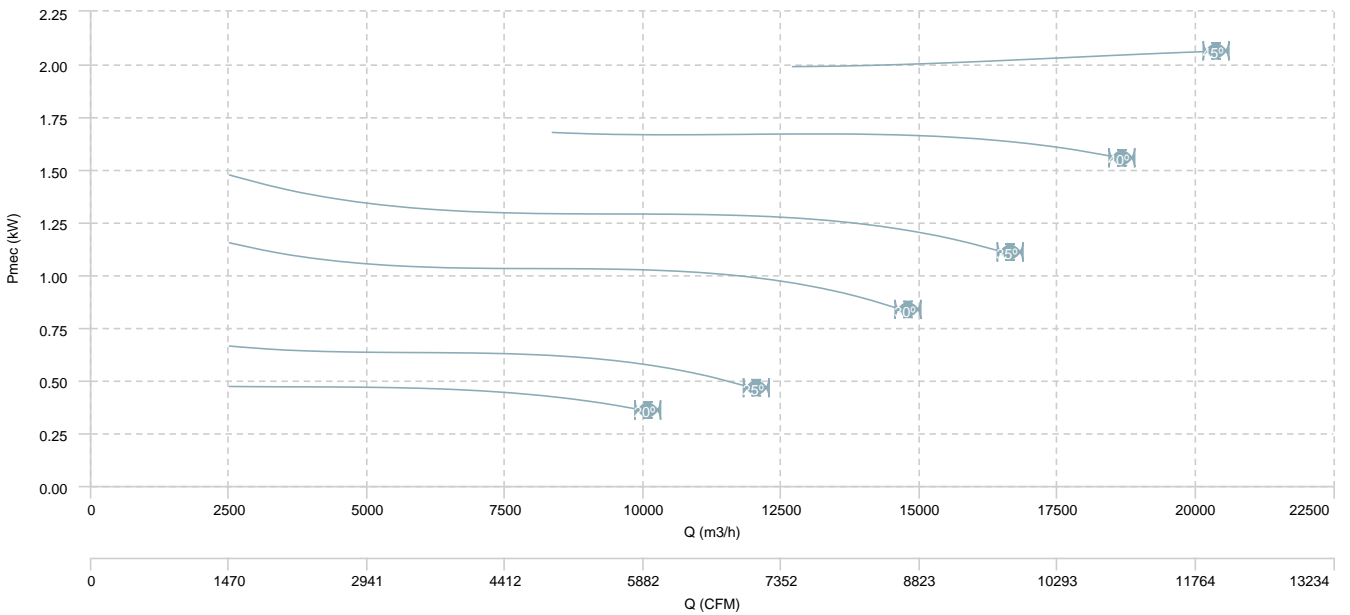

HB 63 T4/T8 (A5:6)

AIR FLOW - PRESSURE (8 poles)

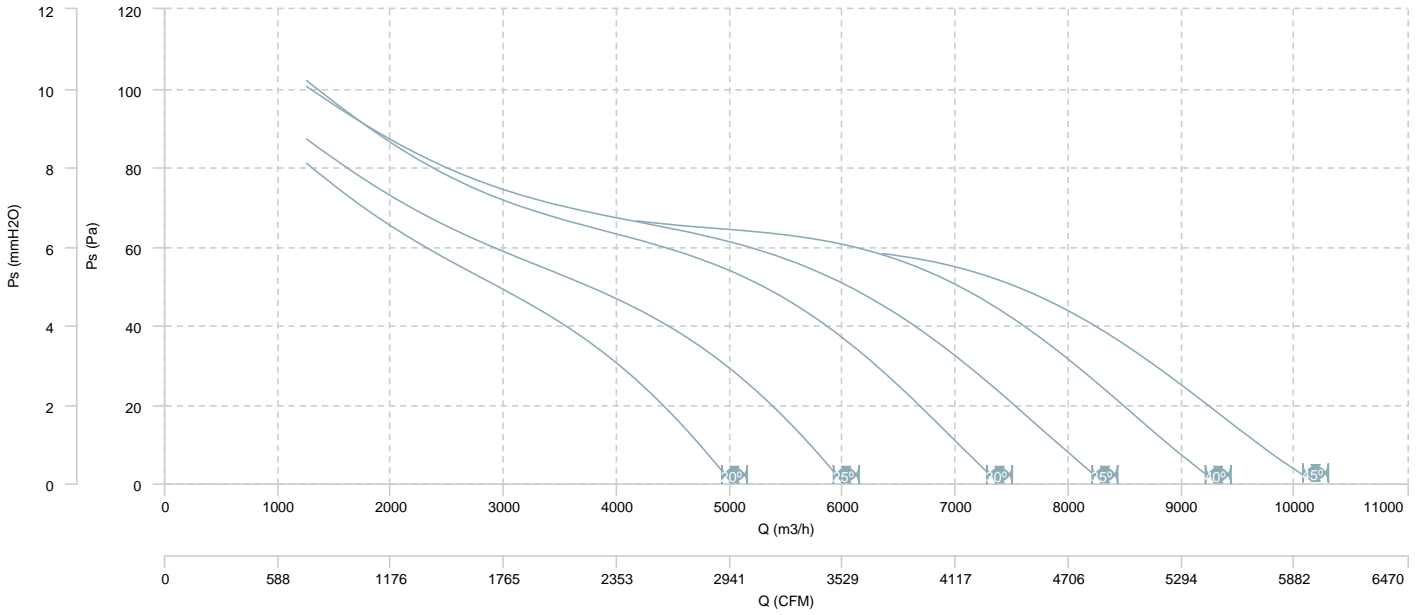

AIR FLOW - MECHANICAL POWER (8 poles)

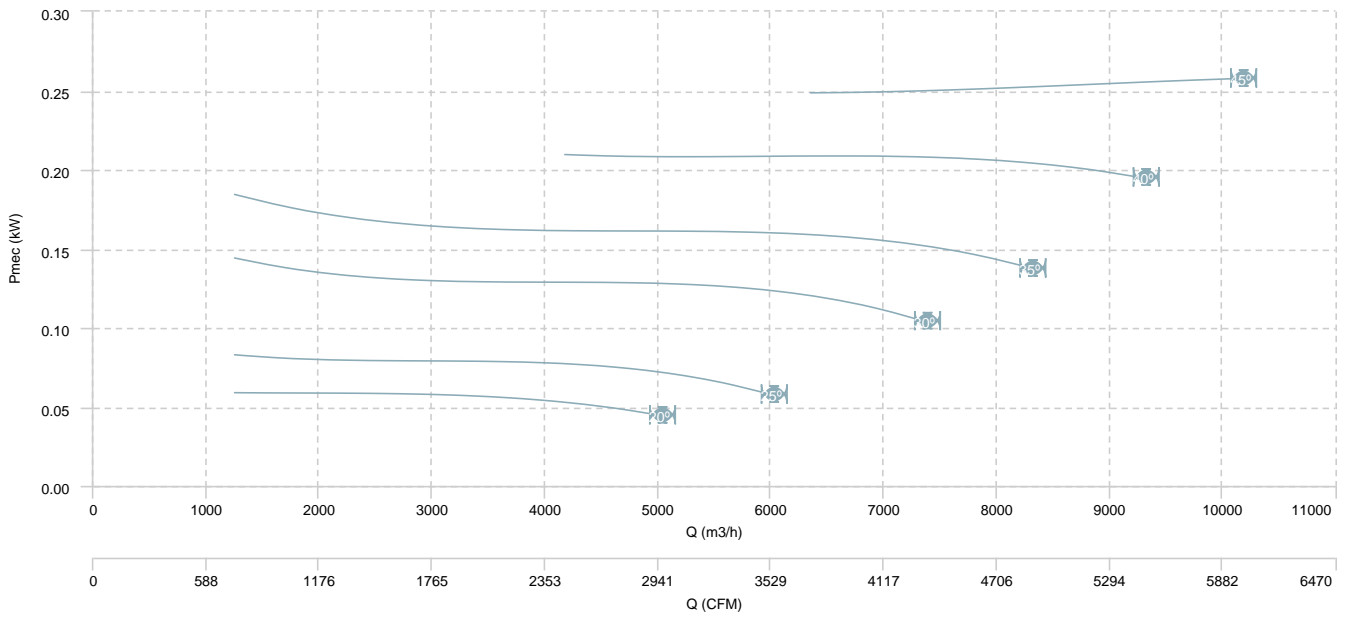

HB 71 T4 (A5:6)

AIR FLOW - PRESSURE

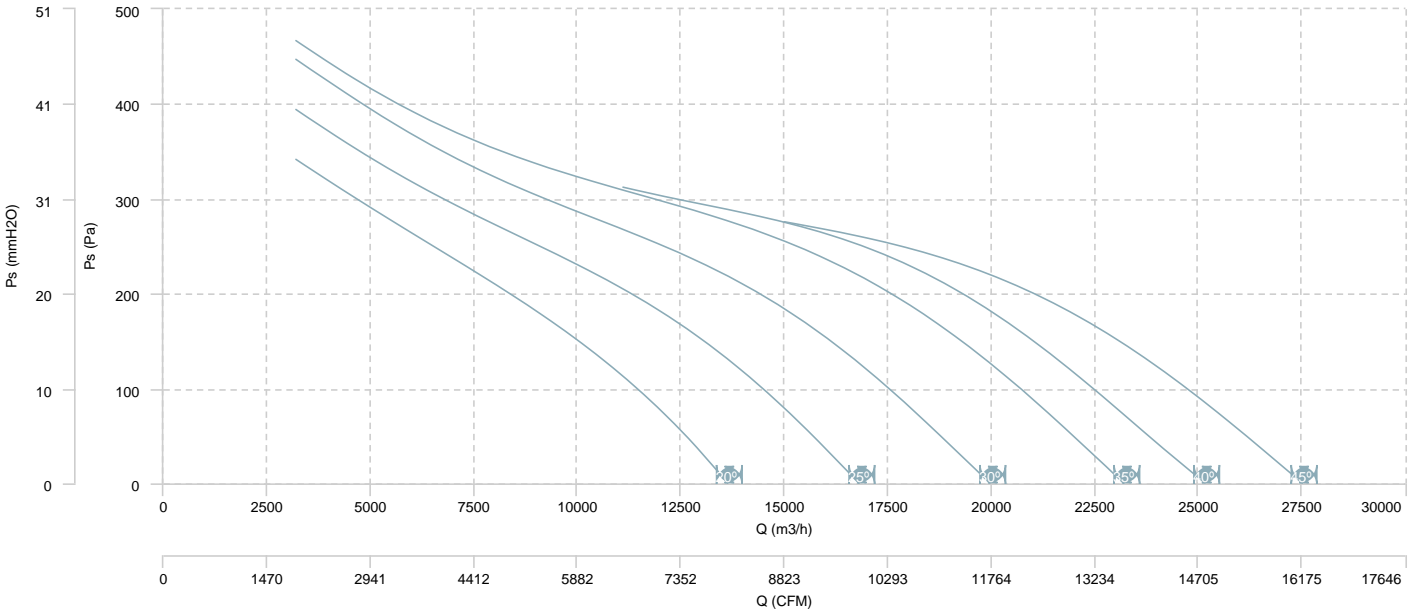

AIR FLOW - MECHANICAL POWER

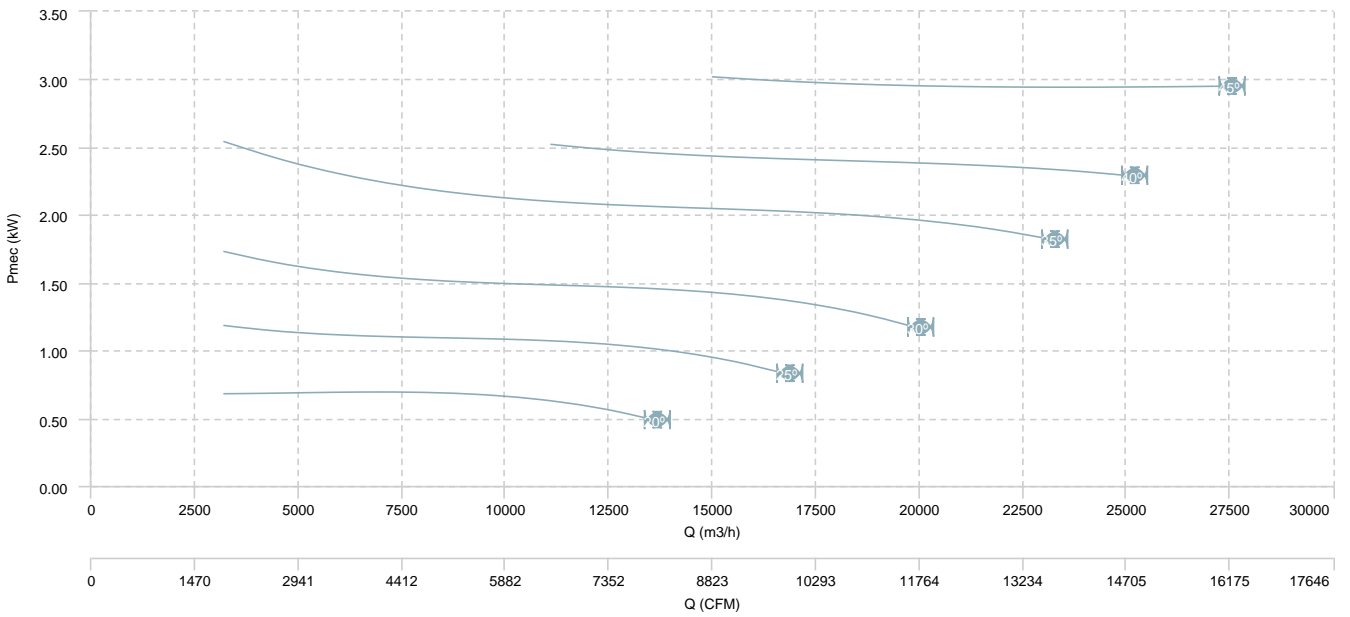

HB 71 T4 (A2:9)

AIR FLOW - PRESSURE

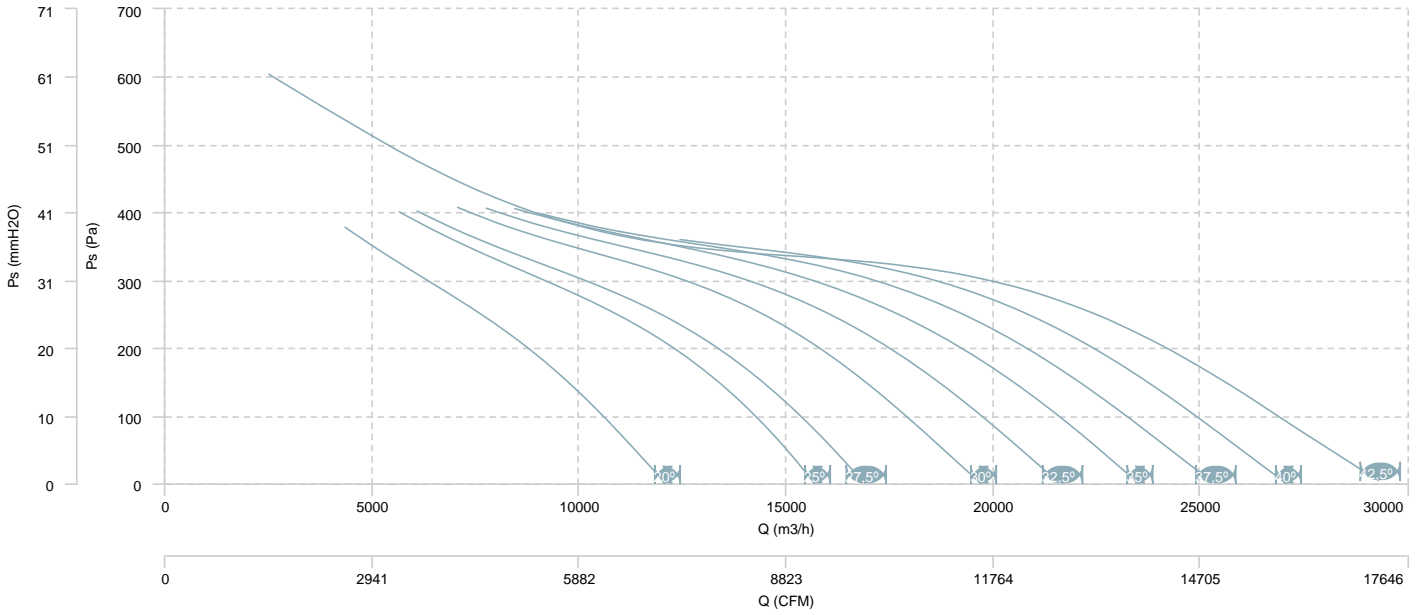

AIR FLOW - MECHANICAL POWER

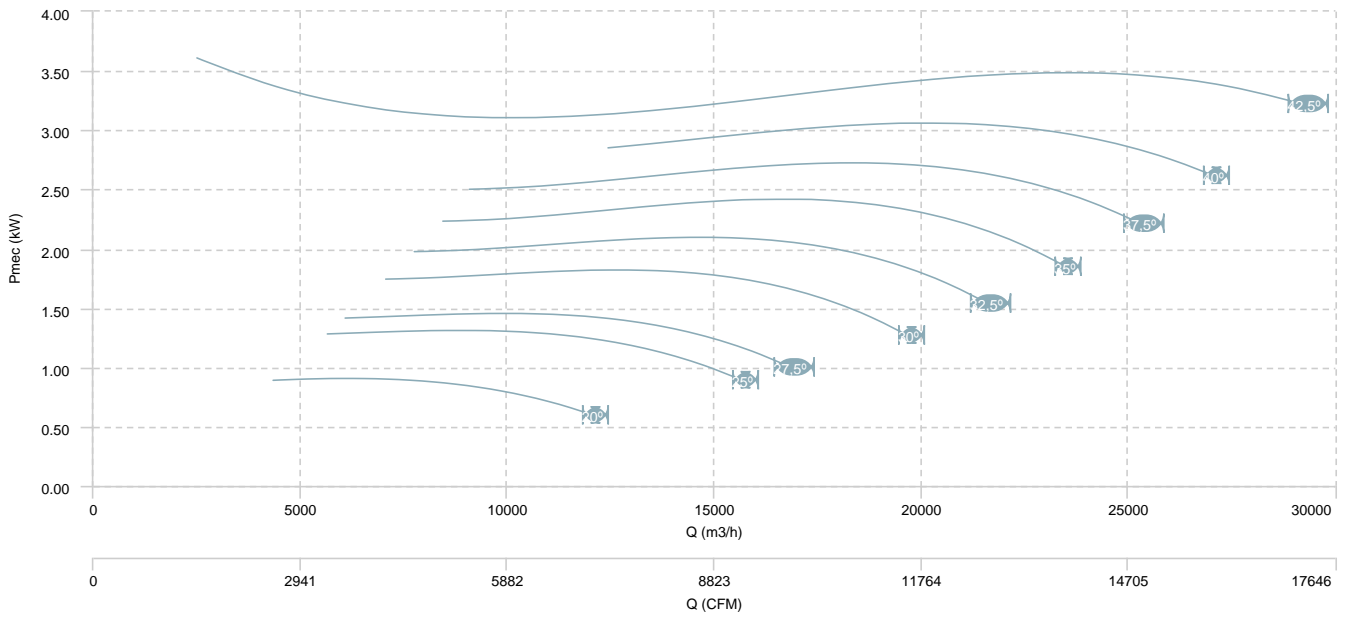

HB 71 T4 (A2:6)

AIR FLOW - PRESSURE

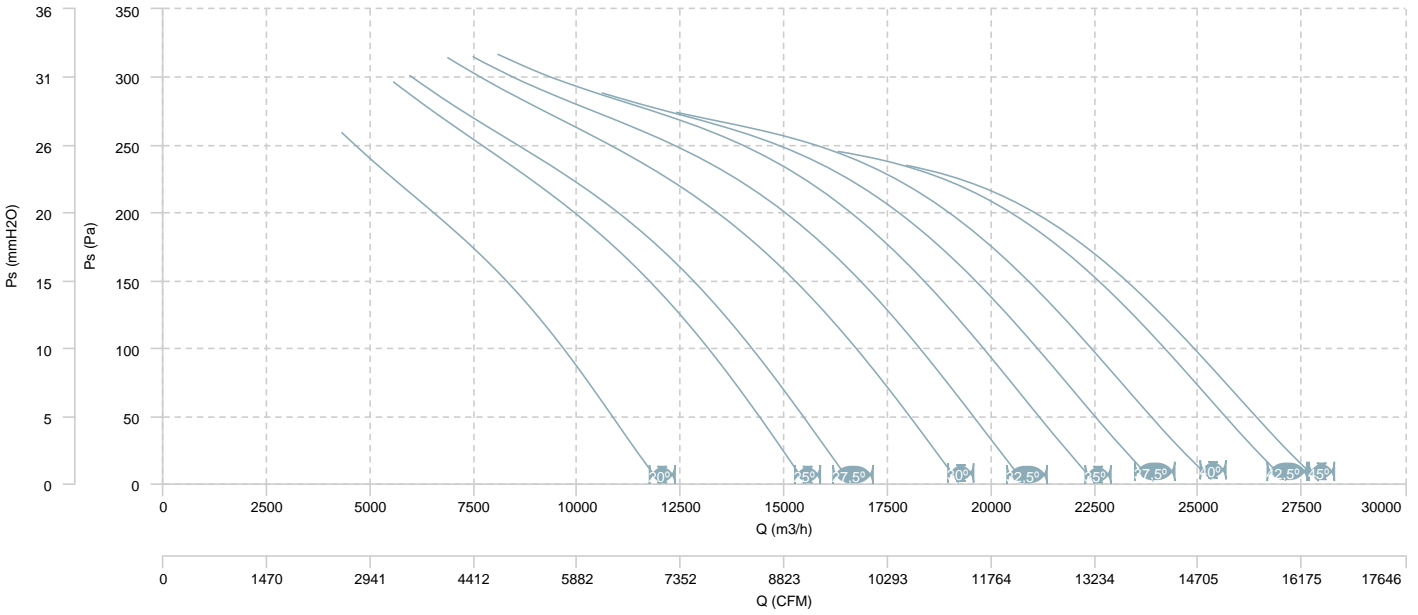

AIR FLOW - MECHANICAL POWER

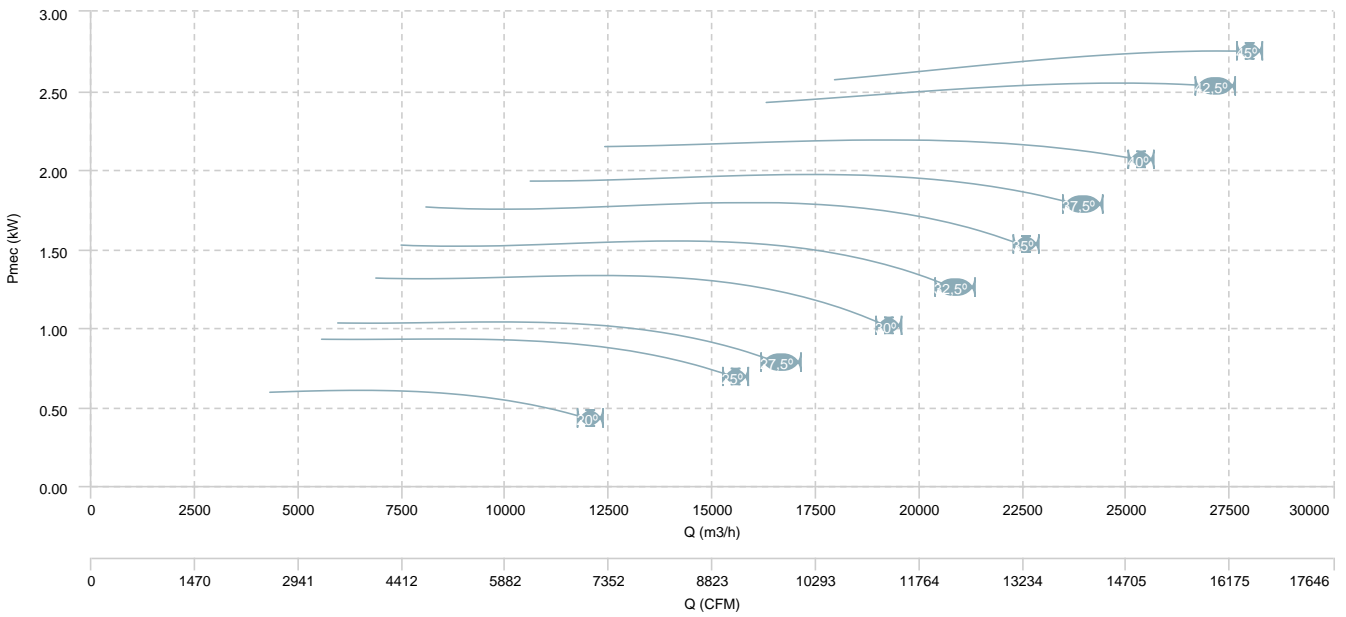

HB 71 T6 (A2:6)

AIR FLOW - PRESSURE

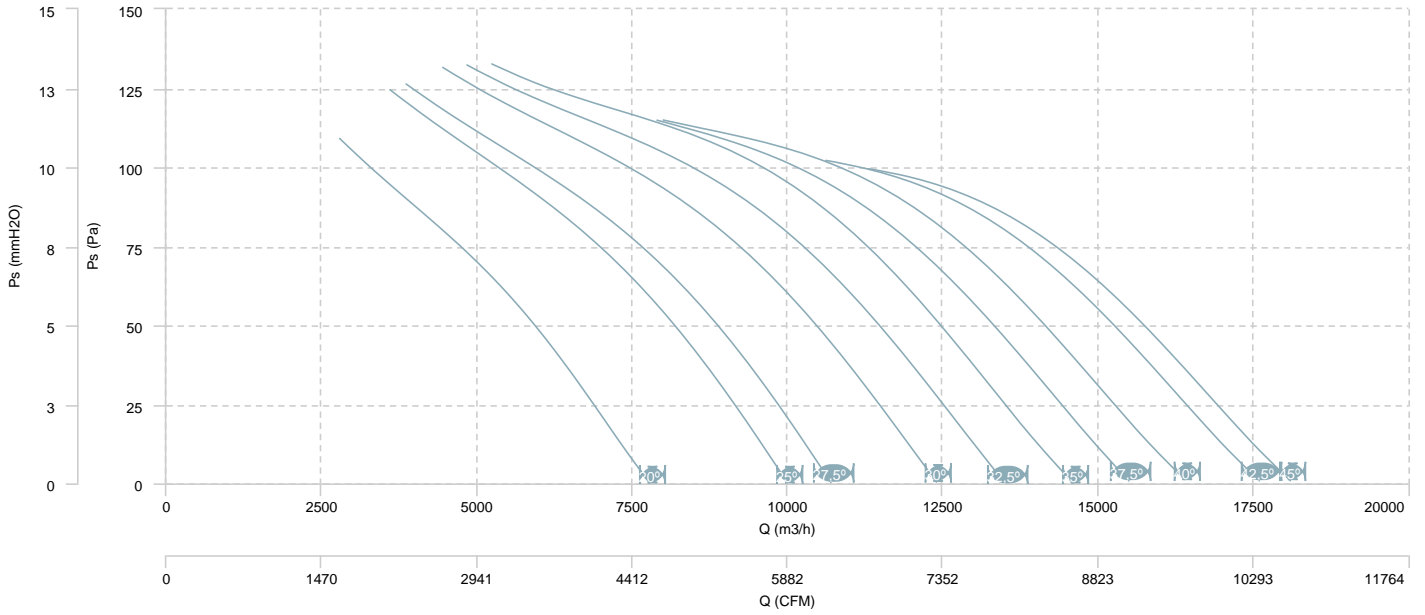

AIR FLOW - MECHANICAL POWER

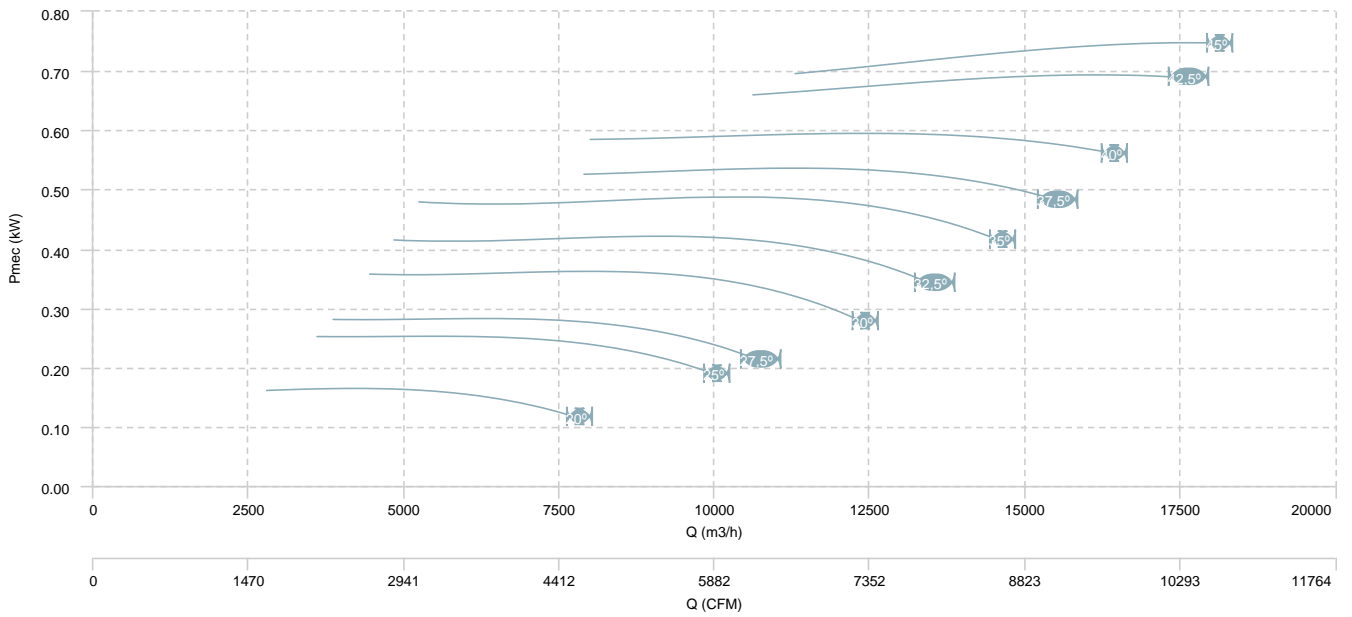

HB 71 T6 (A2:9)

AIR FLOW - PRESSURE

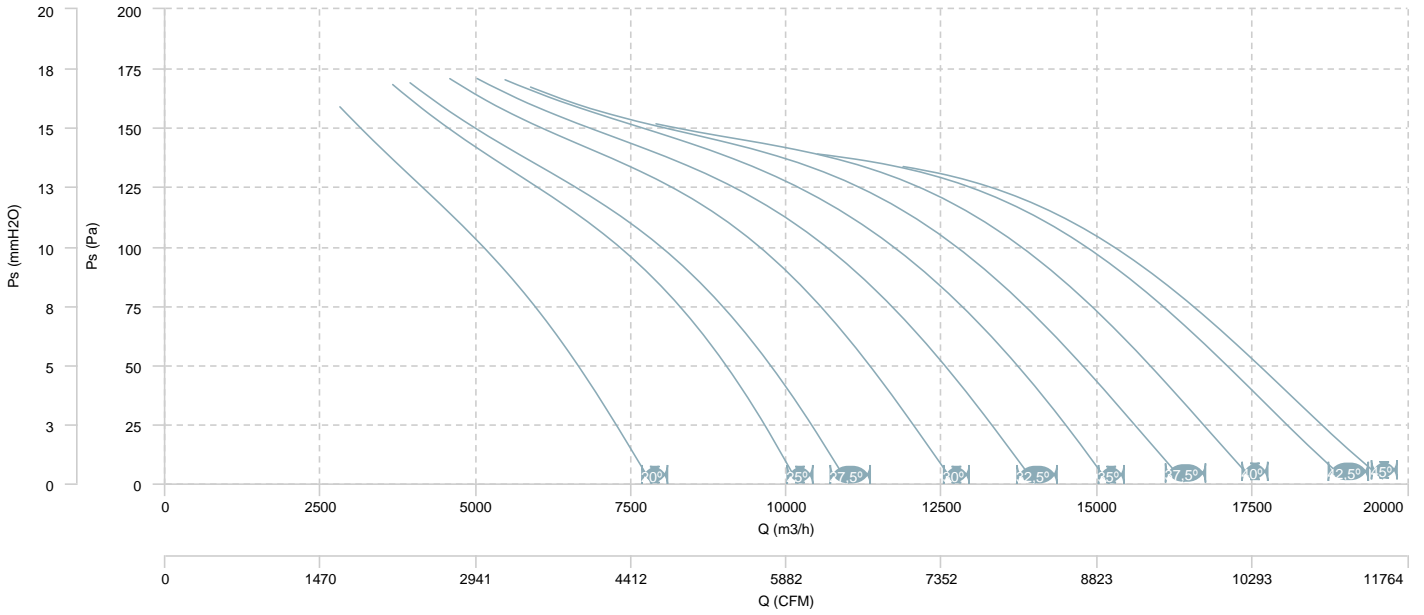

AIR FLOW - MECHANICAL POWER

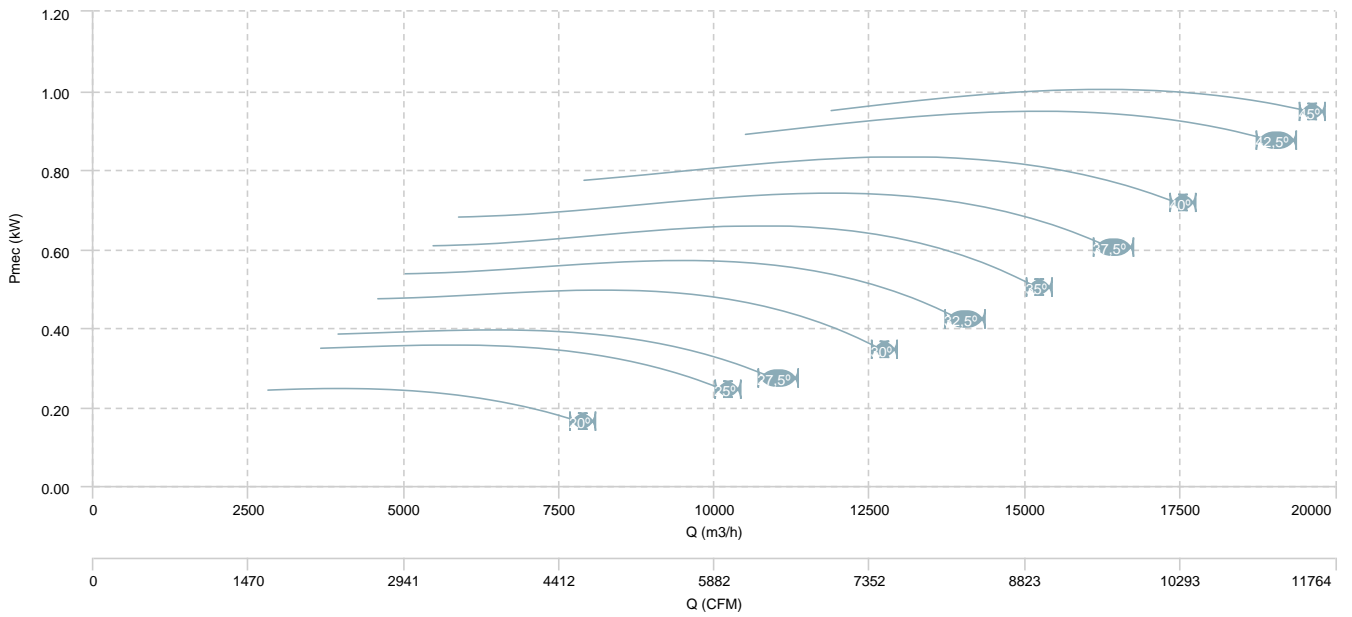

HB 71 T6 (A5:6)

AIR FLOW - PRESSURE

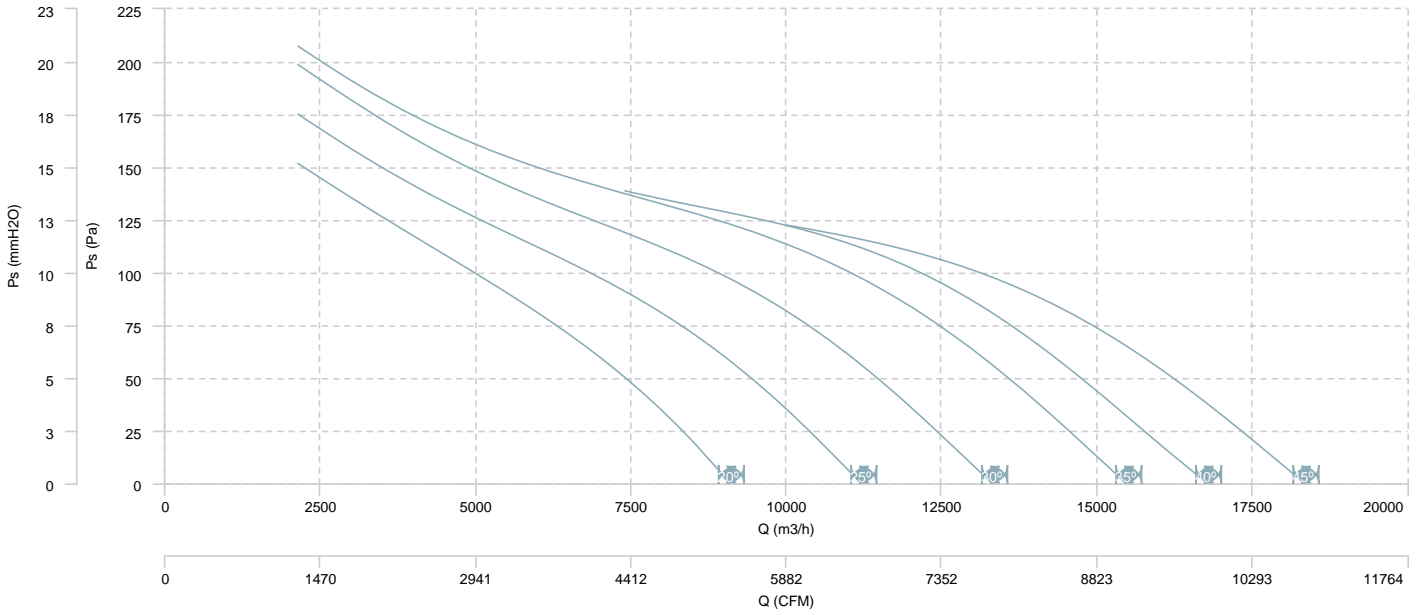

AIR FLOW - MECHANICAL POWER

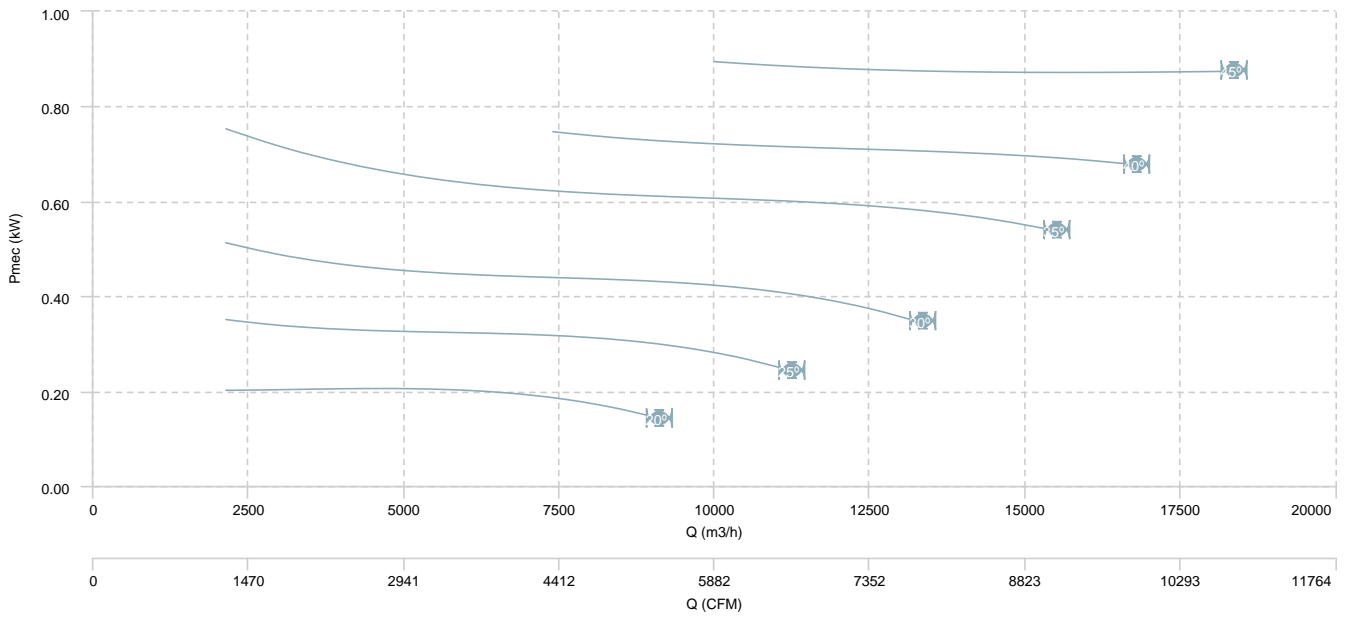

HB 71 T4/T8 (A2:6)

AIR FLOW - PRESSURE (4 poles)

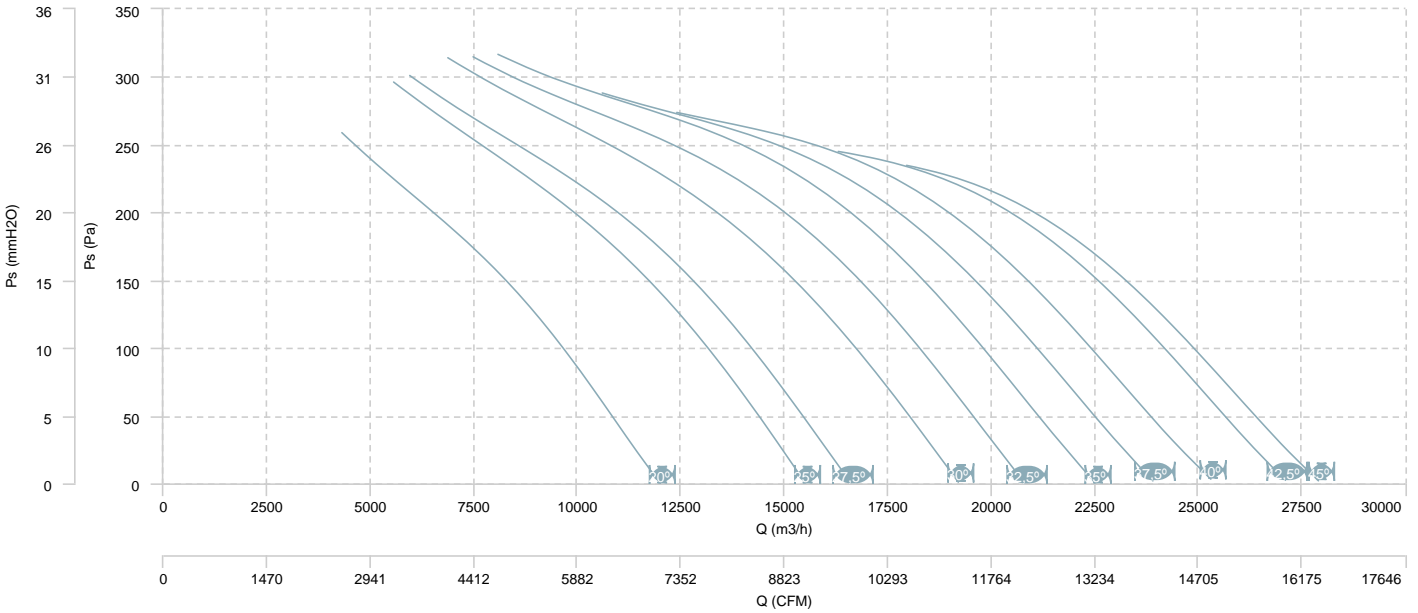

AIR FLOW - MECHANICAL POWER (4 poles)

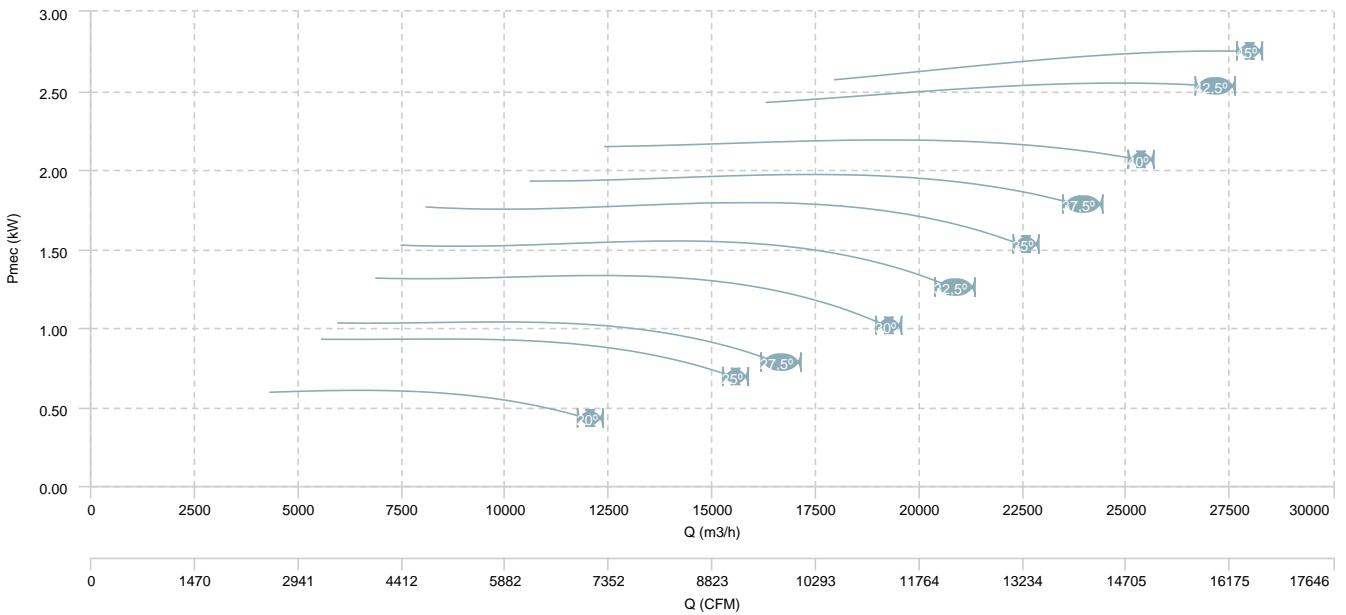

HB 71 T4/T8 (A2:6)

AIR FLOW - PRESSURE (8 poles)

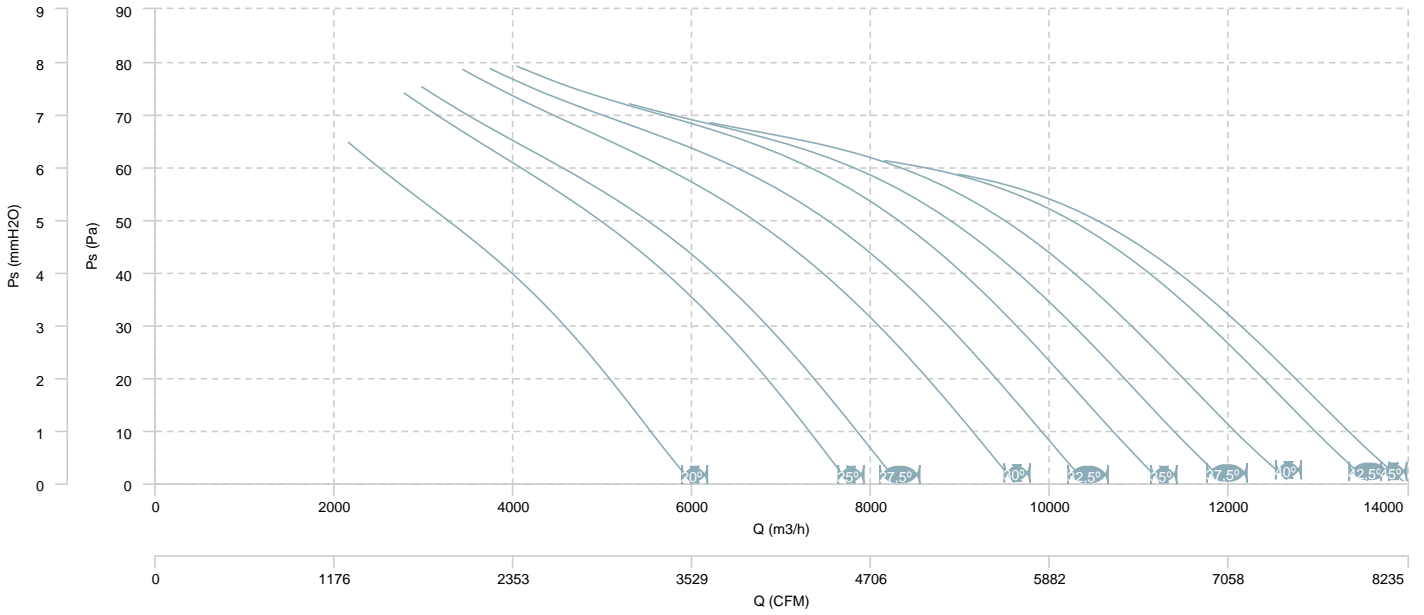

AIR FLOW - MECHANICAL POWER (8 poles)

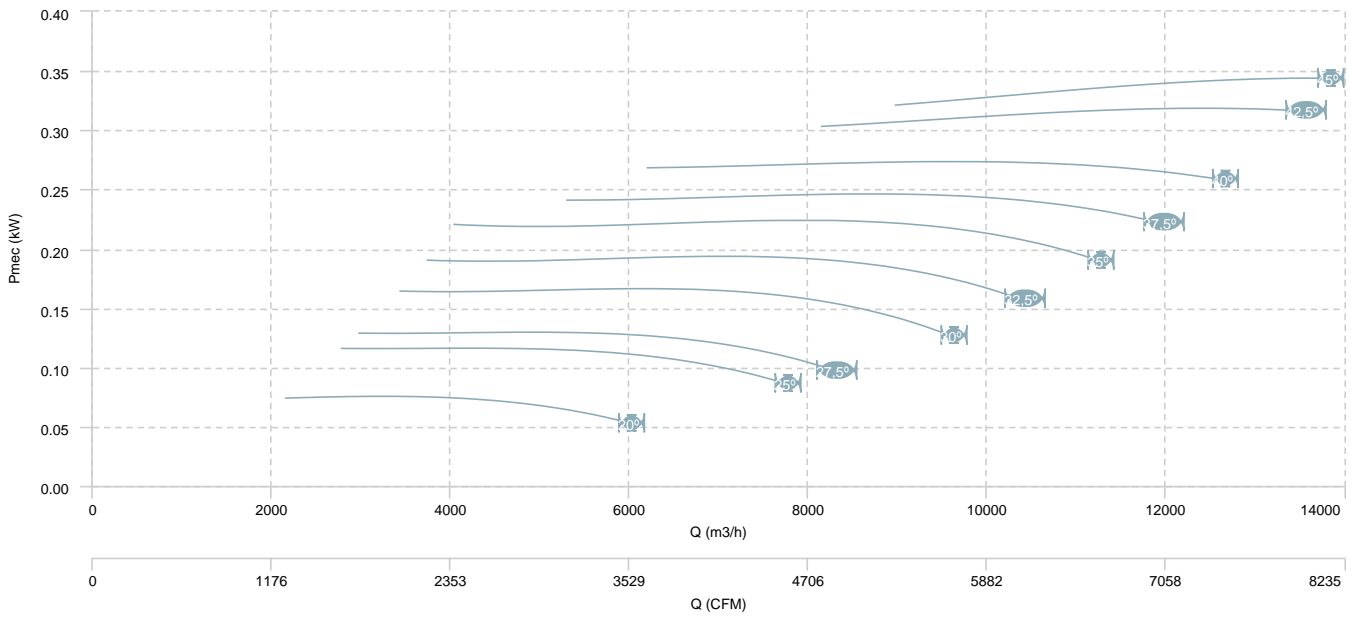

HB 71 T4/T8 (A2:9)

AIR FLOW - PRESSURE (4 poles)

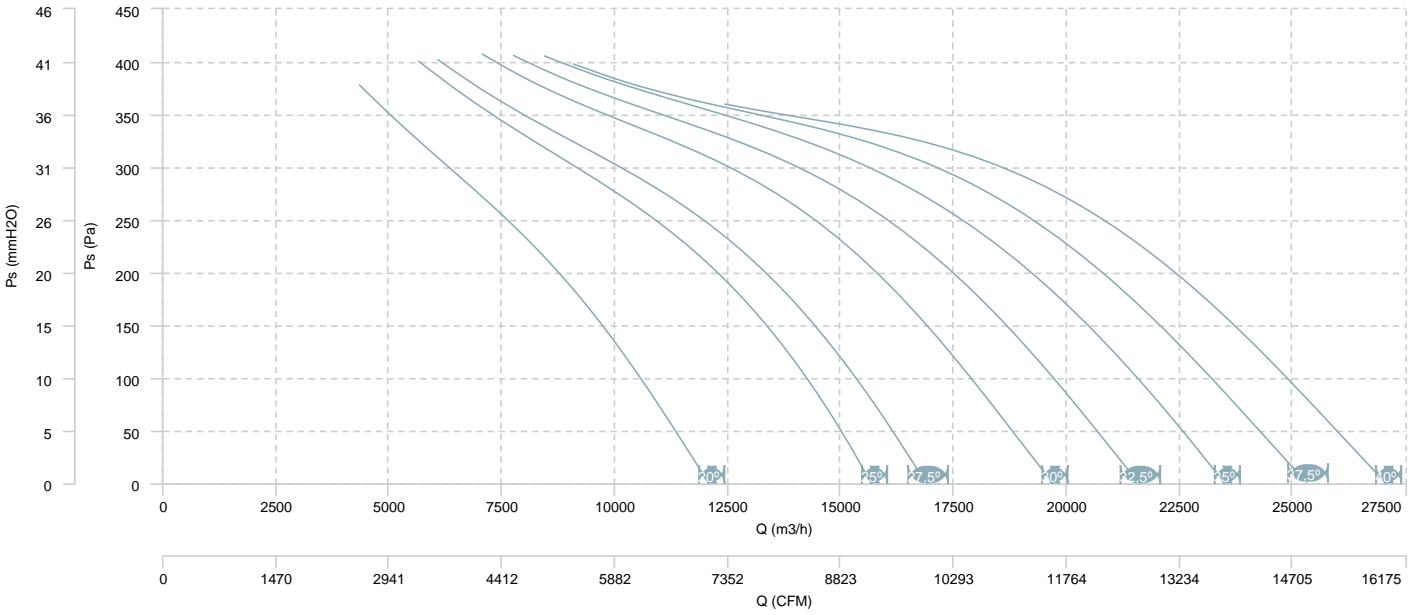

AIR FLOW - MECHANICAL POWER (4 poles)

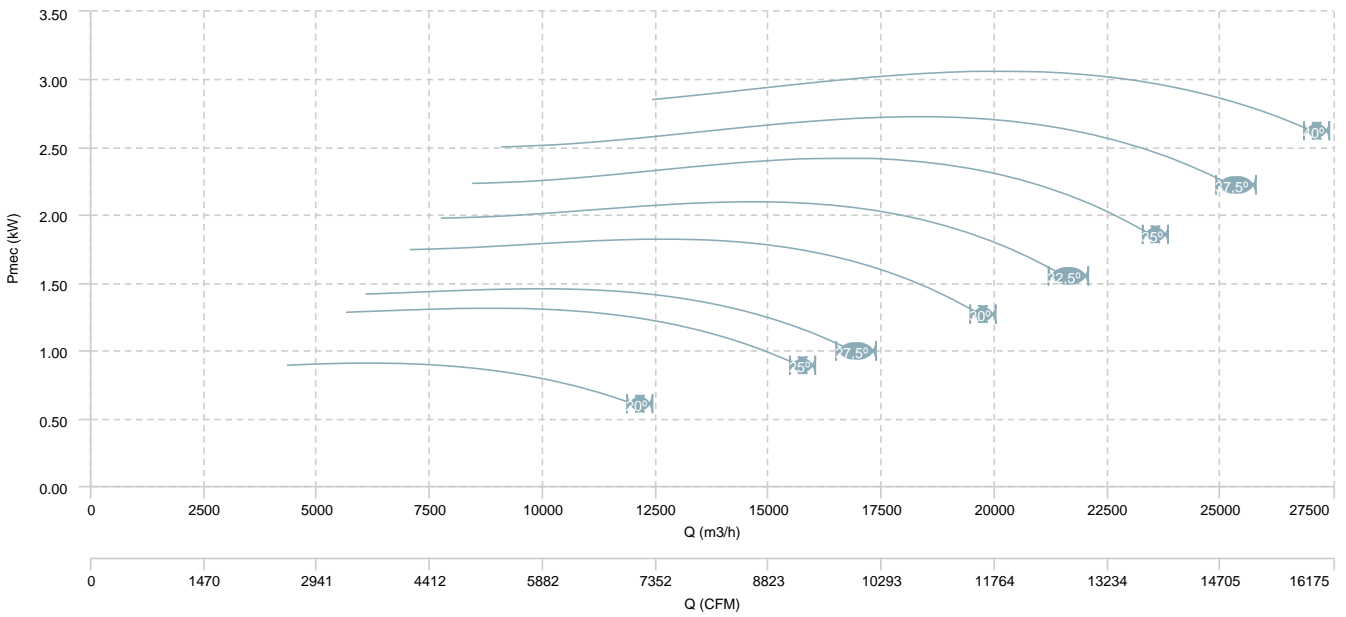

HB 71 T4/T8 (A2:9)

AIR FLOW - PRESSURE (8 poles)

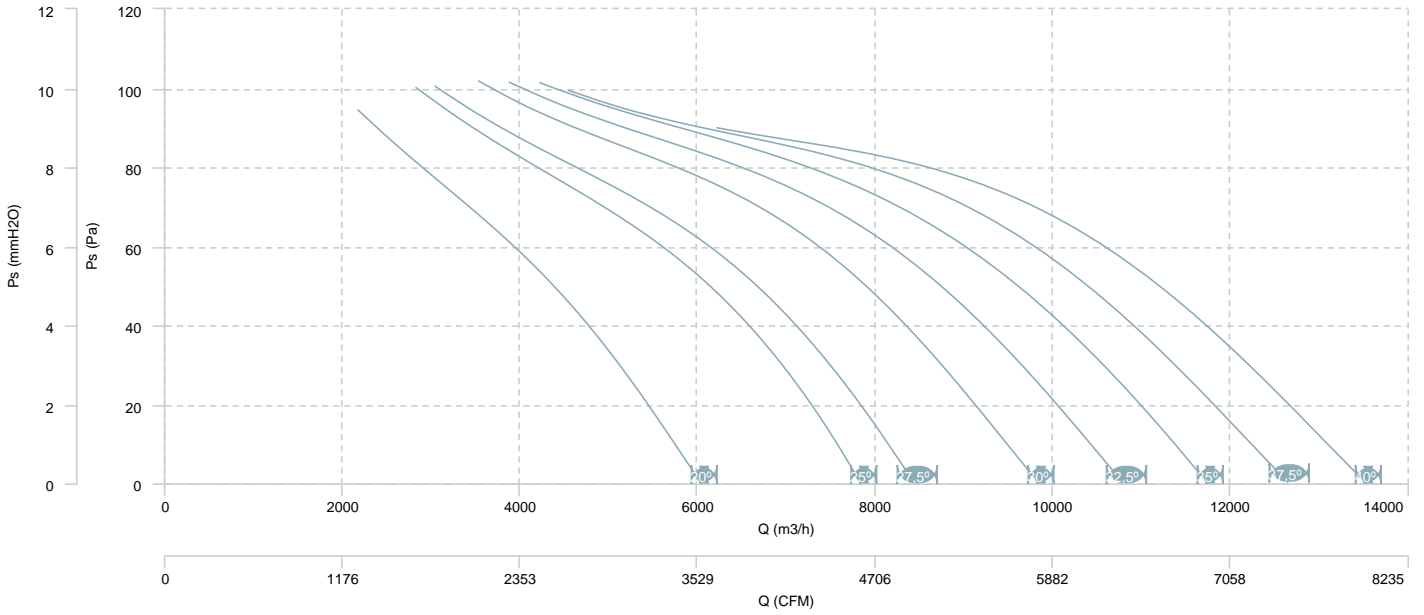

AIR FLOW - MECHANICAL POWER (8 poles)

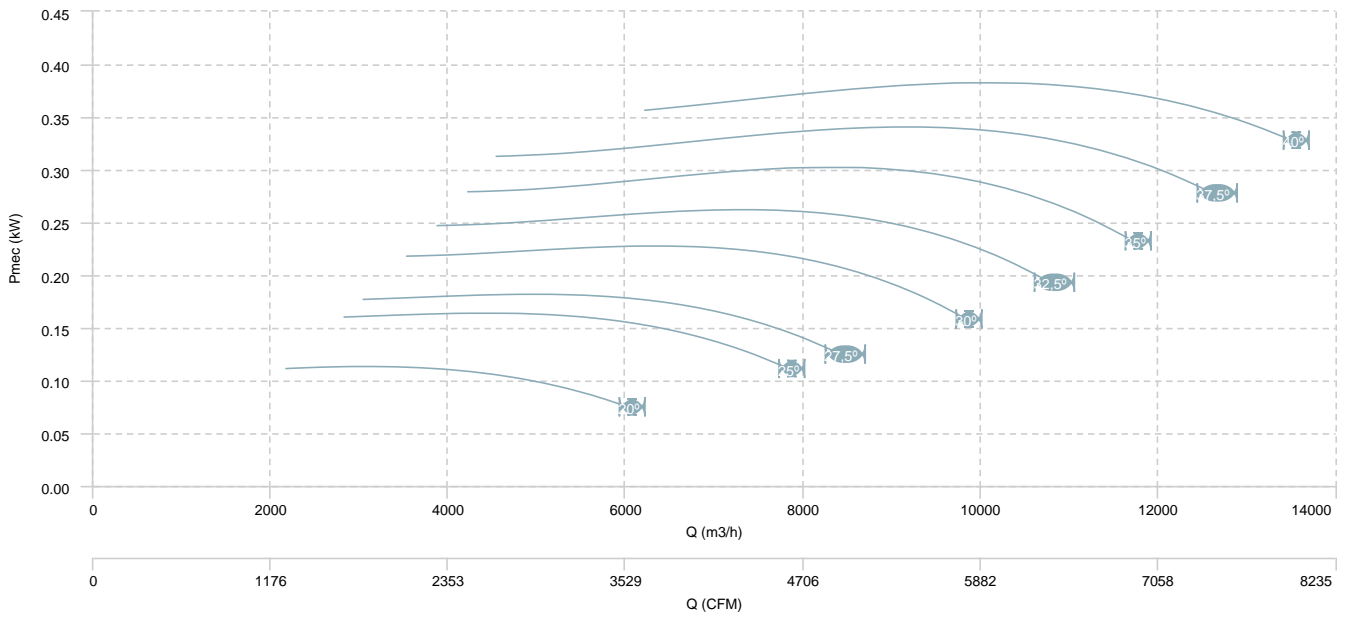

HB 71 T4/T8 (A5:6)

AIR FLOW - PRESSURE (4 poles)

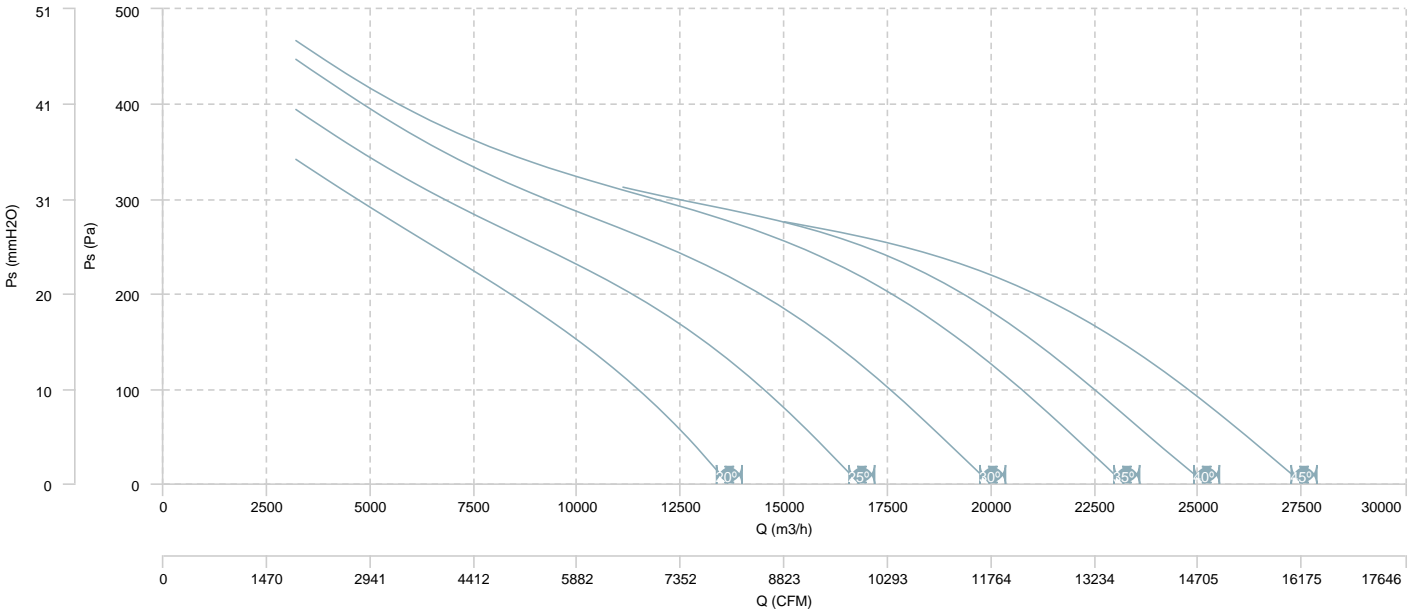

AIR FLOW - MECHANICAL POWER (4 poles)

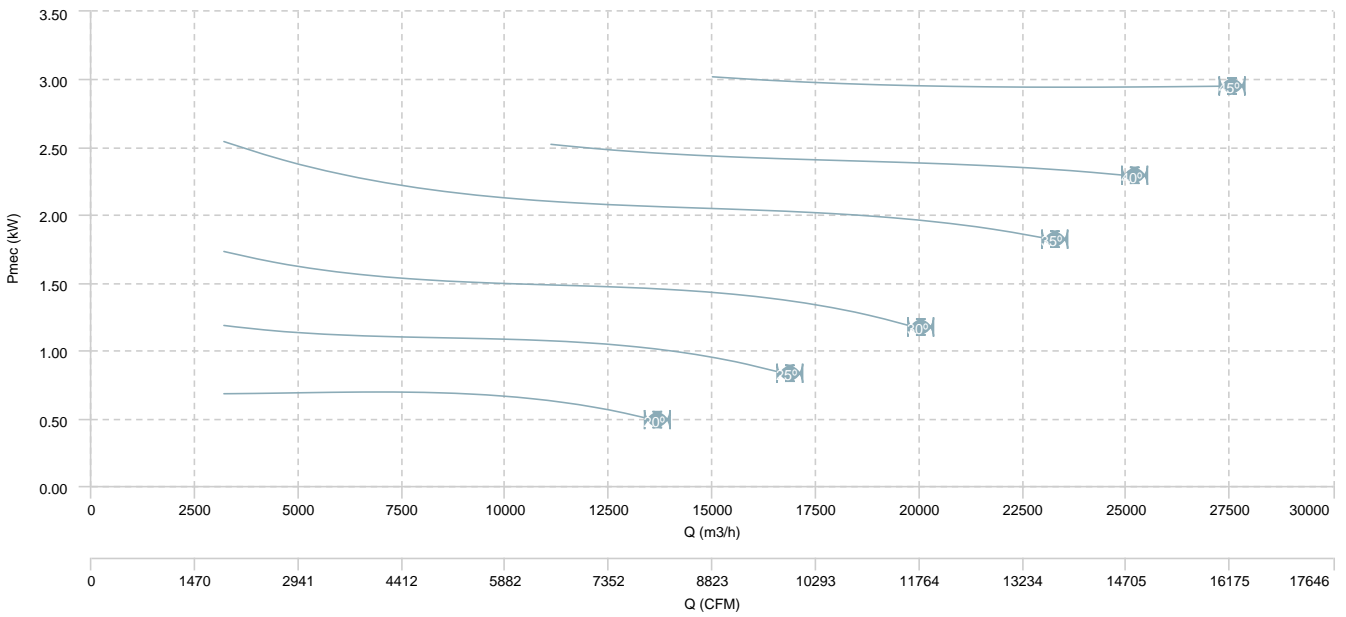

HB 71 T4/T8 (A5:6)

AIR FLOW - PRESSURE (8 poles)

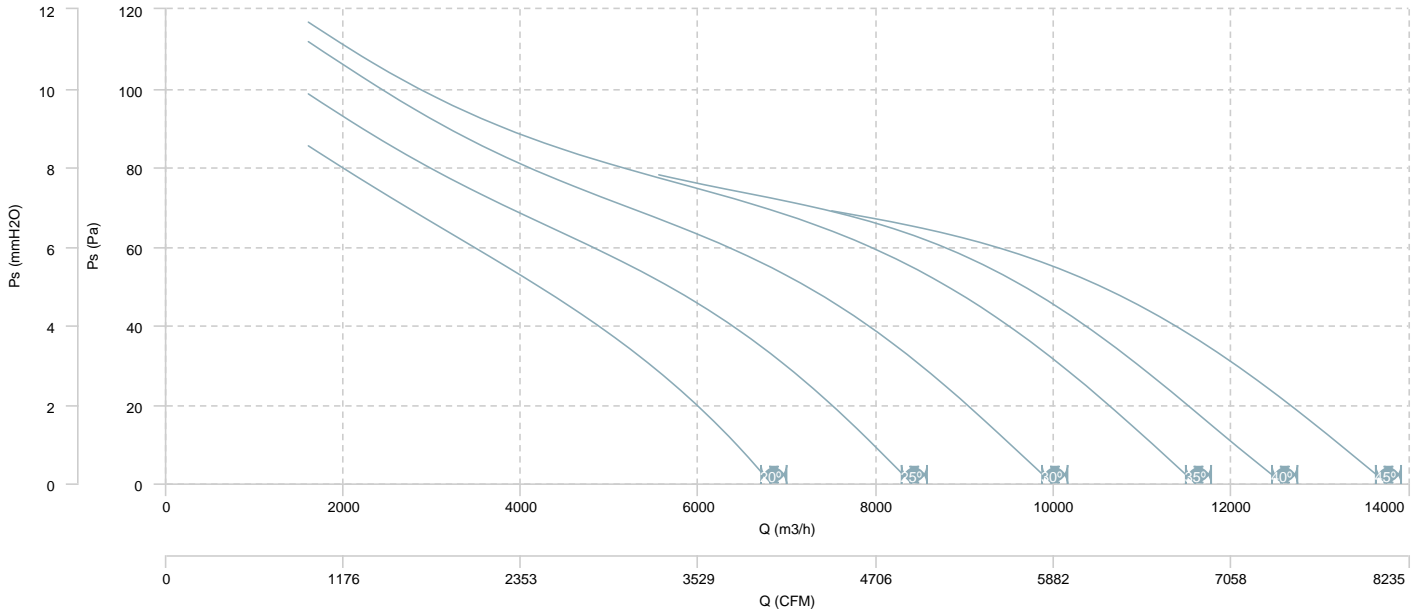

AIR FLOW - MECHANICAL POWER (8 poles)

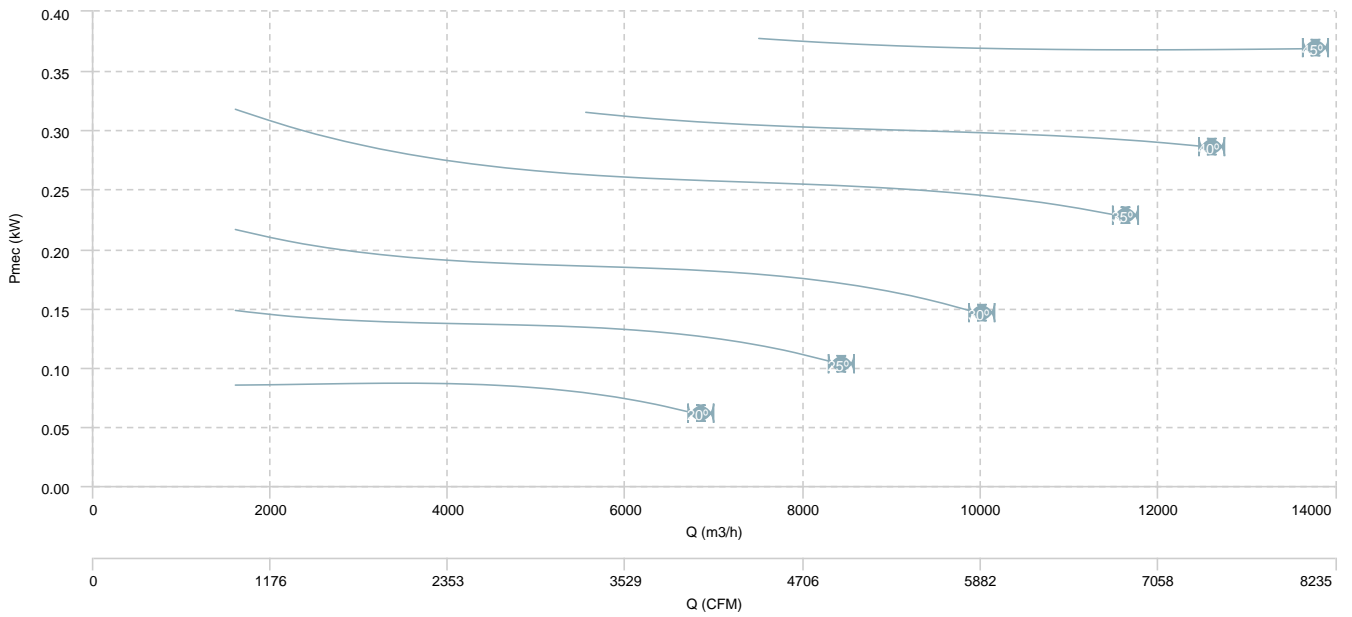

HB 80 T4 (A5:6)

AIR FLOW - PRESSURE

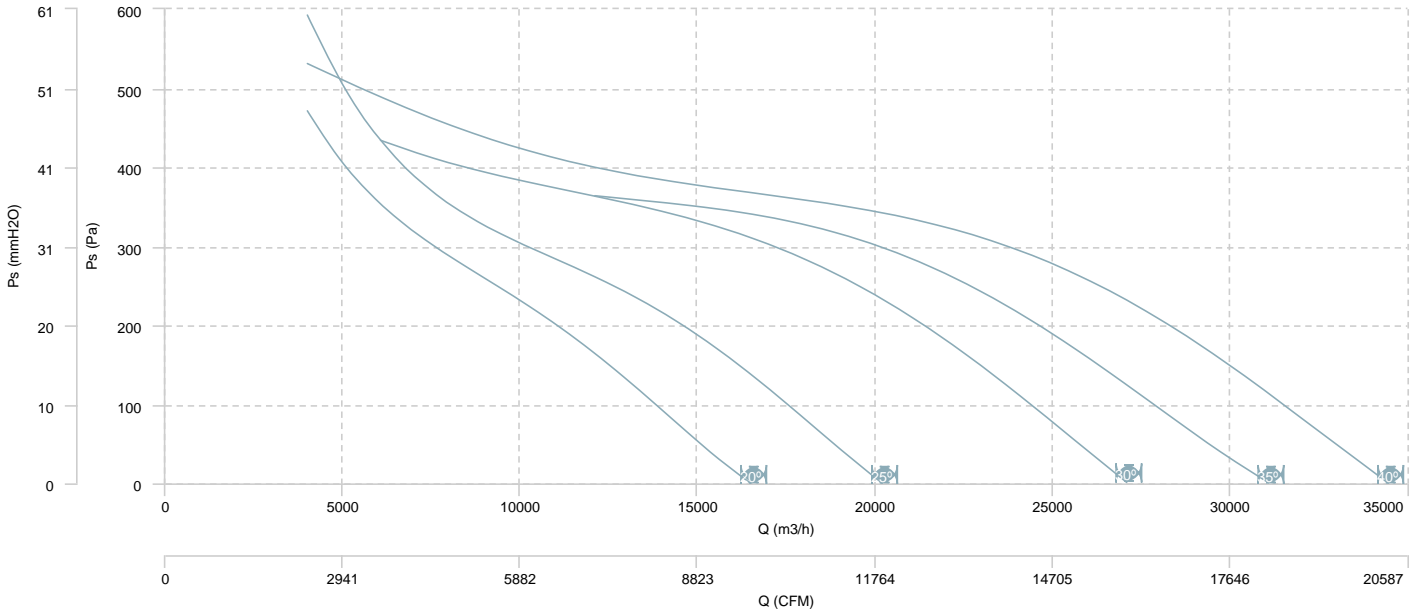

AIR FLOW - MECHANICAL POWER

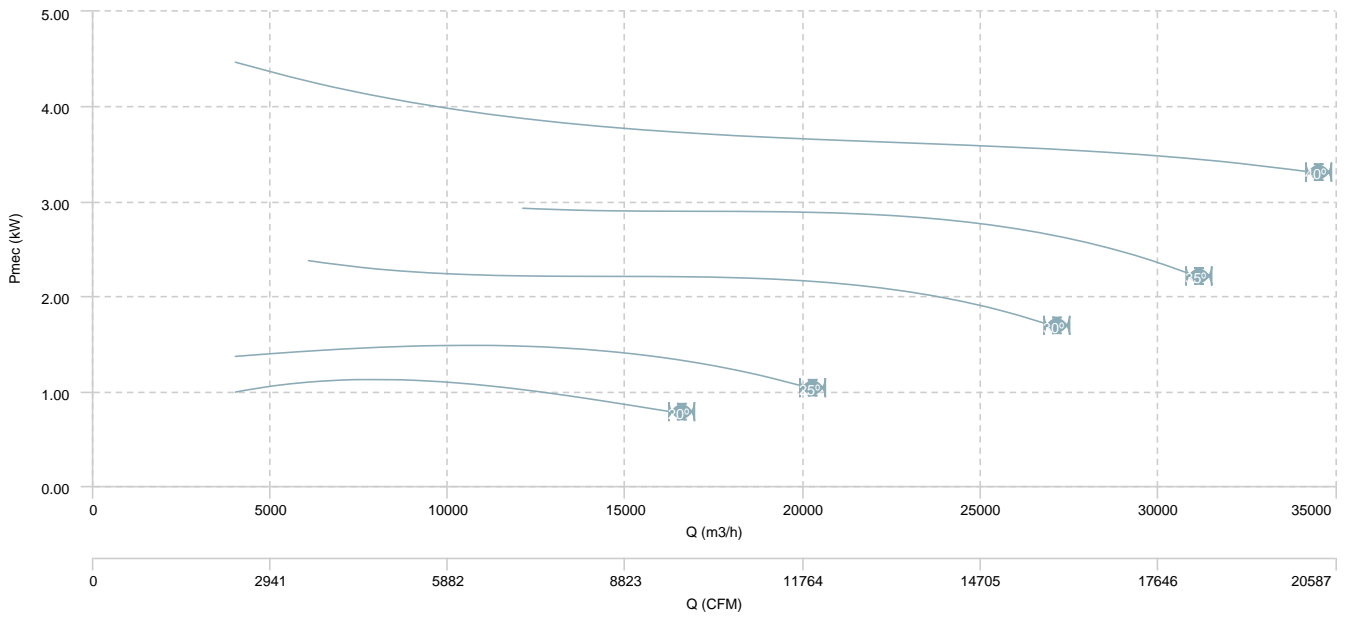

HB 80 T4 (A2:9)

AIR FLOW - PRESSURE

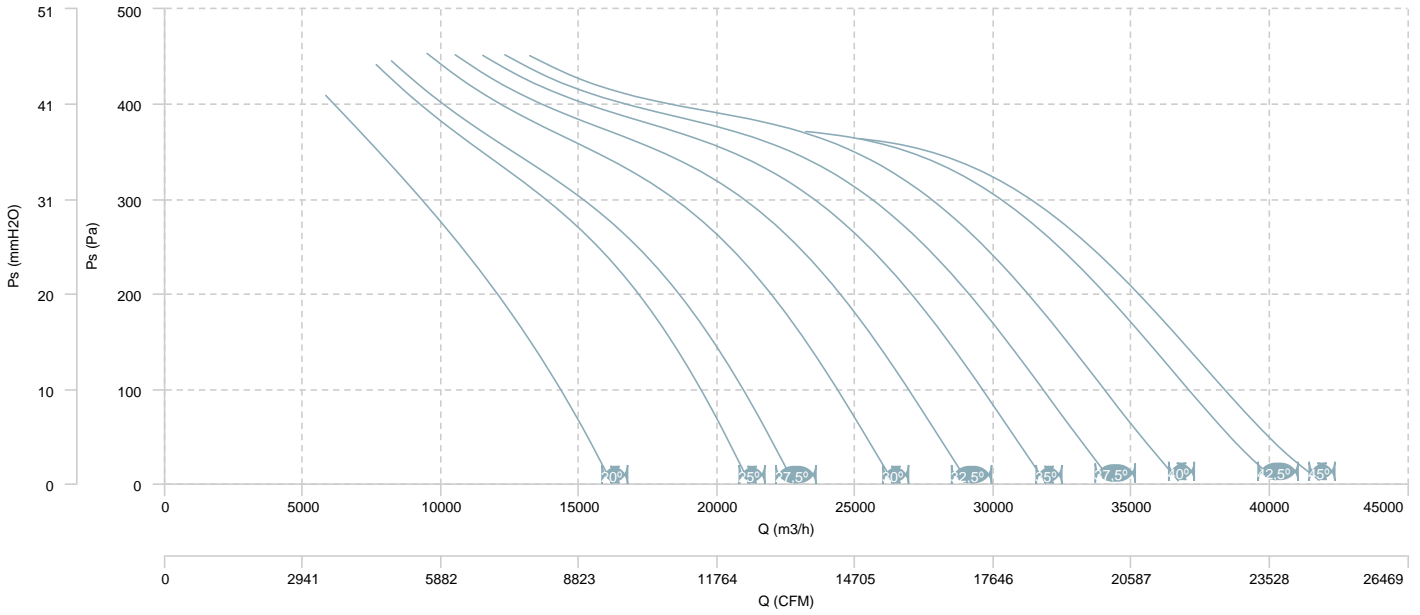

AIR FLOW - MECHANICAL POWER

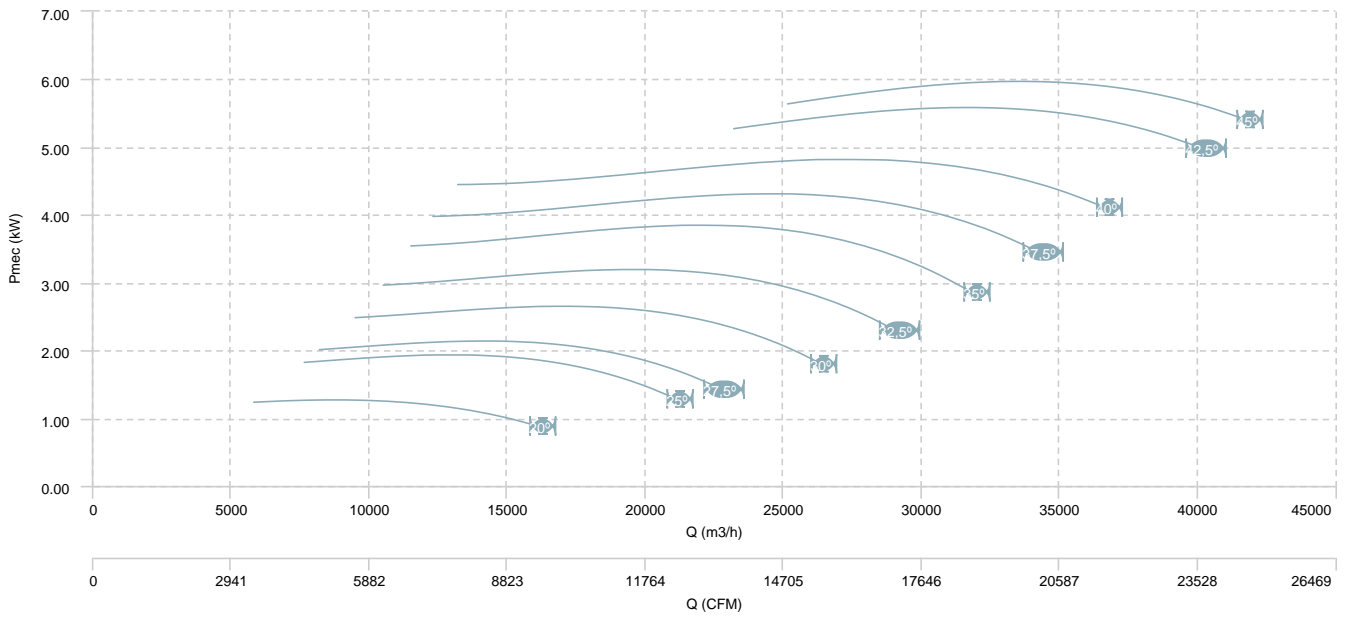

HB 80 T4 (A2:6)

AIR FLOW - PRESSURE

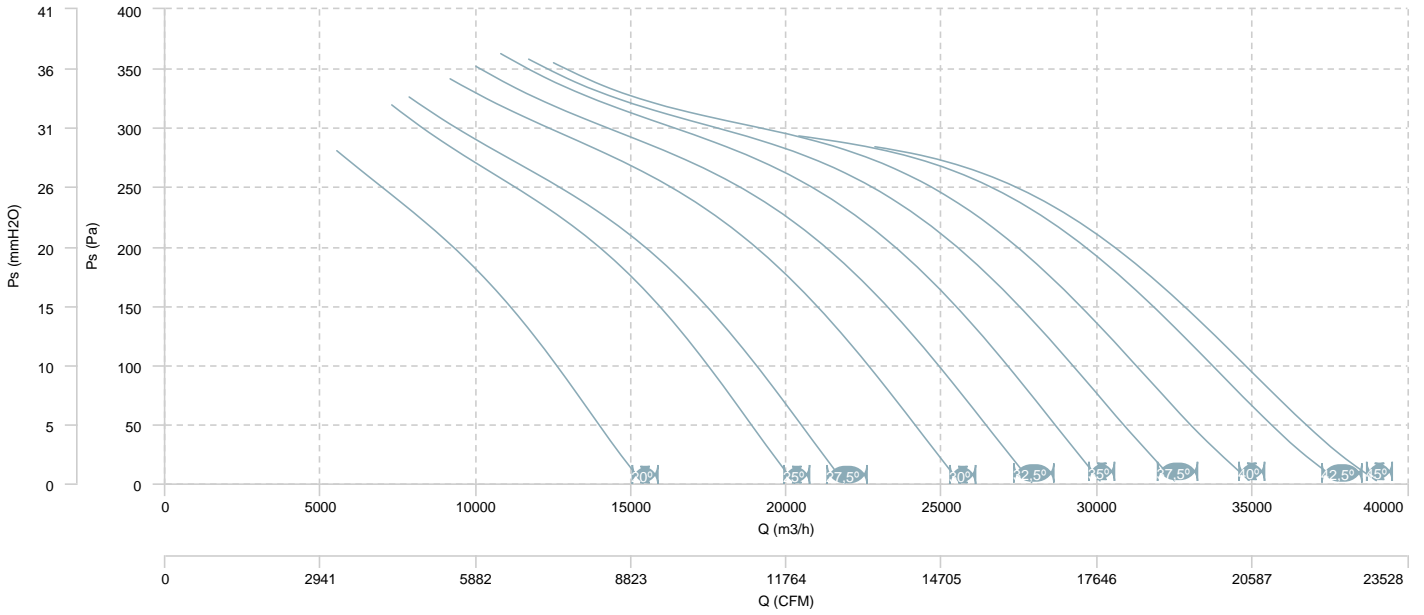

AIR FLOW - MECHANICAL POWER

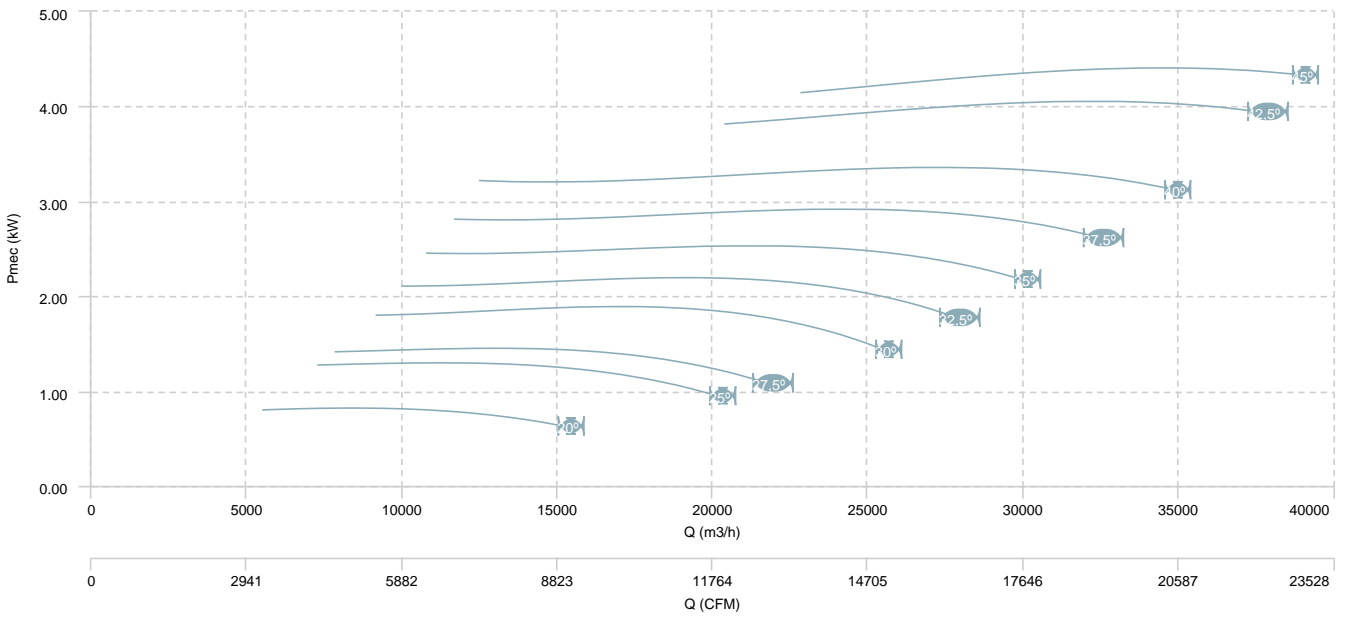

HB 80 T6 (A2:6)

AIR FLOW - PRESSURE

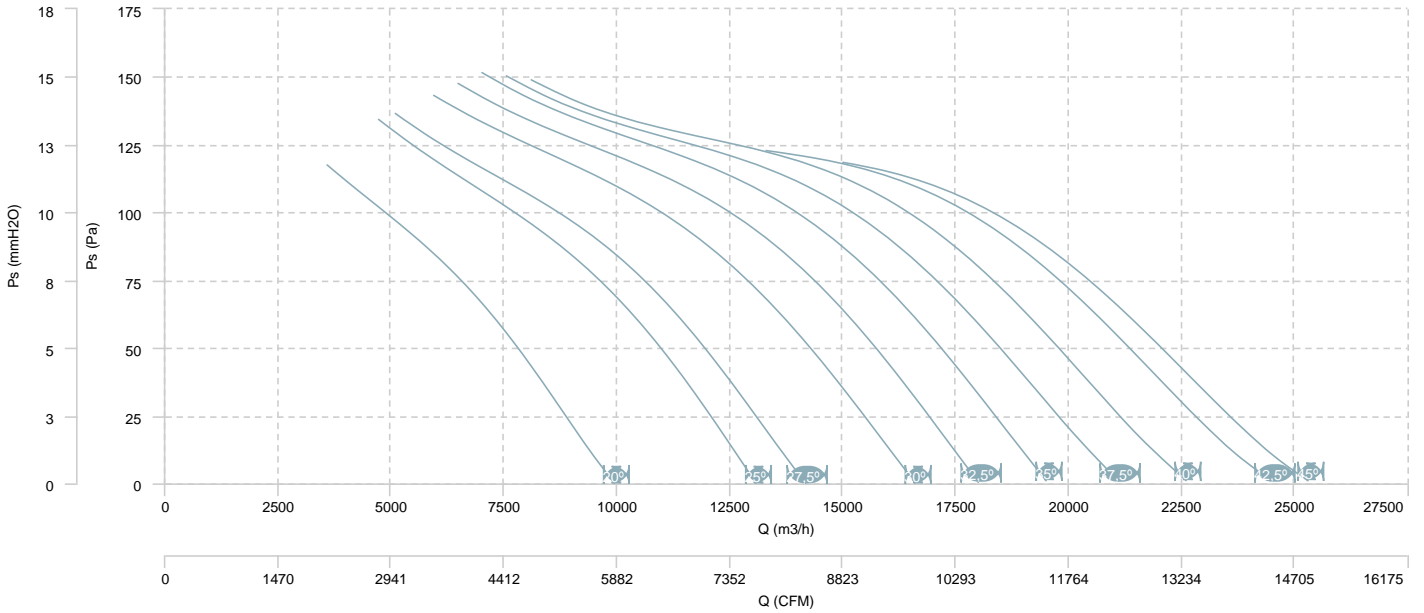

AIR FLOW - MECHANICAL POWER

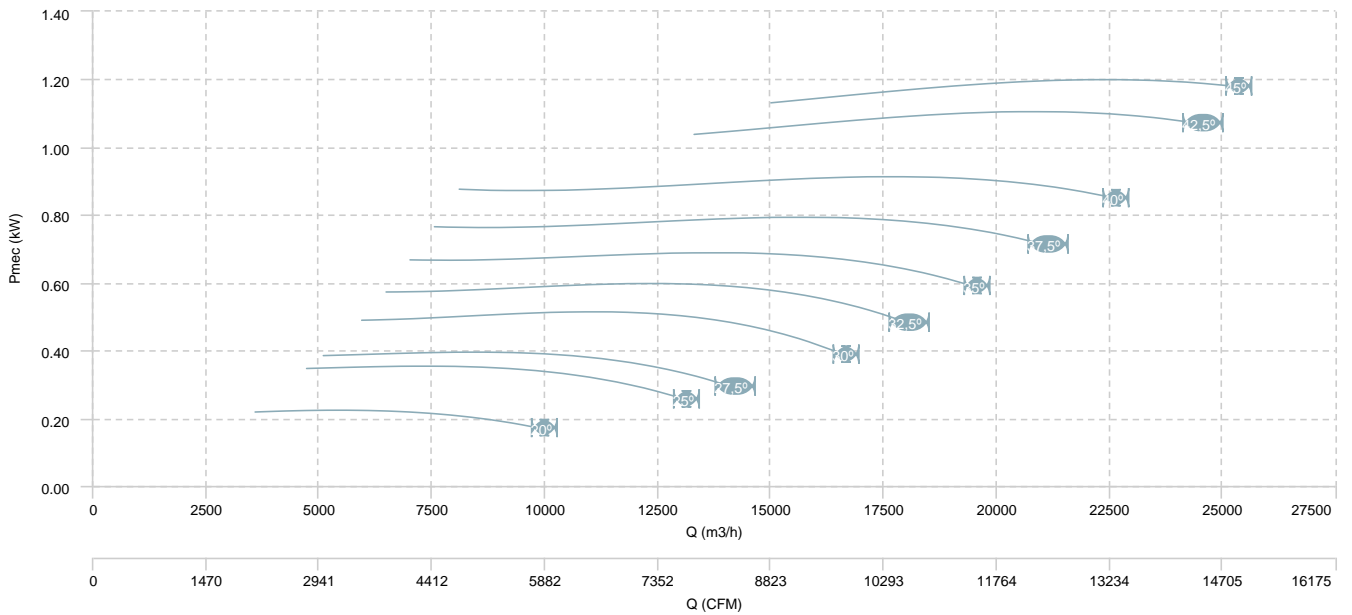

HB 80 T6 (A2:9)

AIR FLOW - PRESSURE

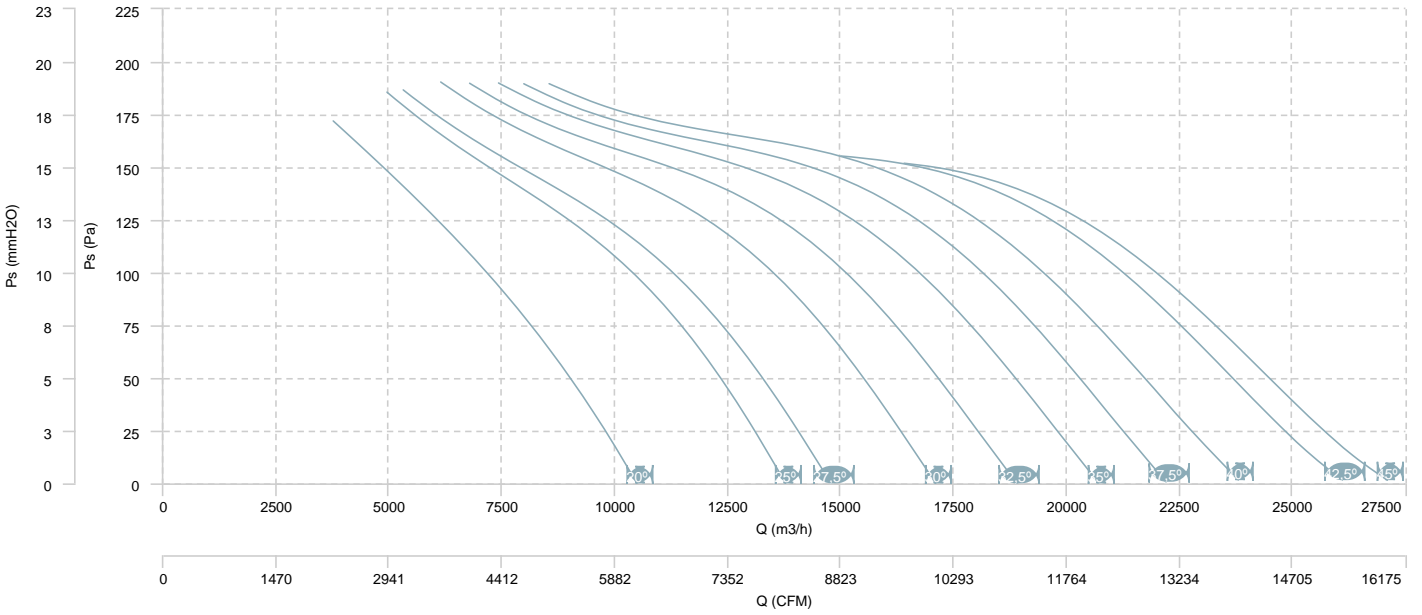

AIR FLOW - MECHANICAL POWER

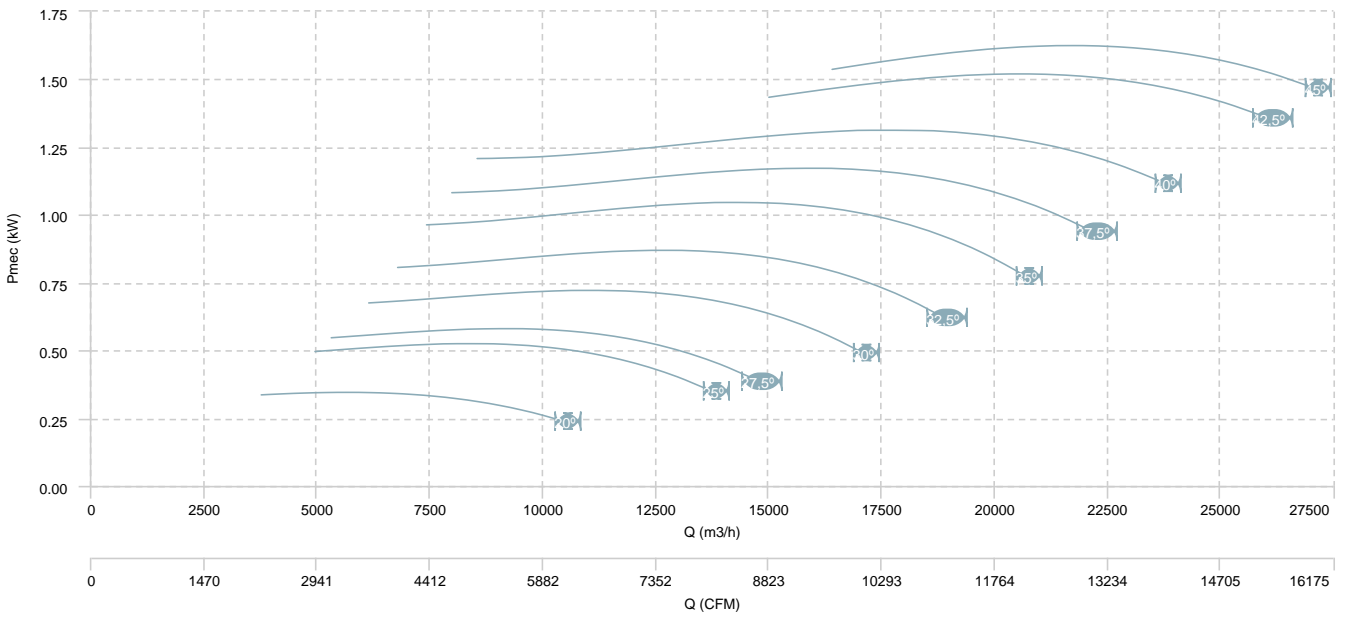

HB 80 T6 (A5:6)

AIR FLOW - PRESSURE

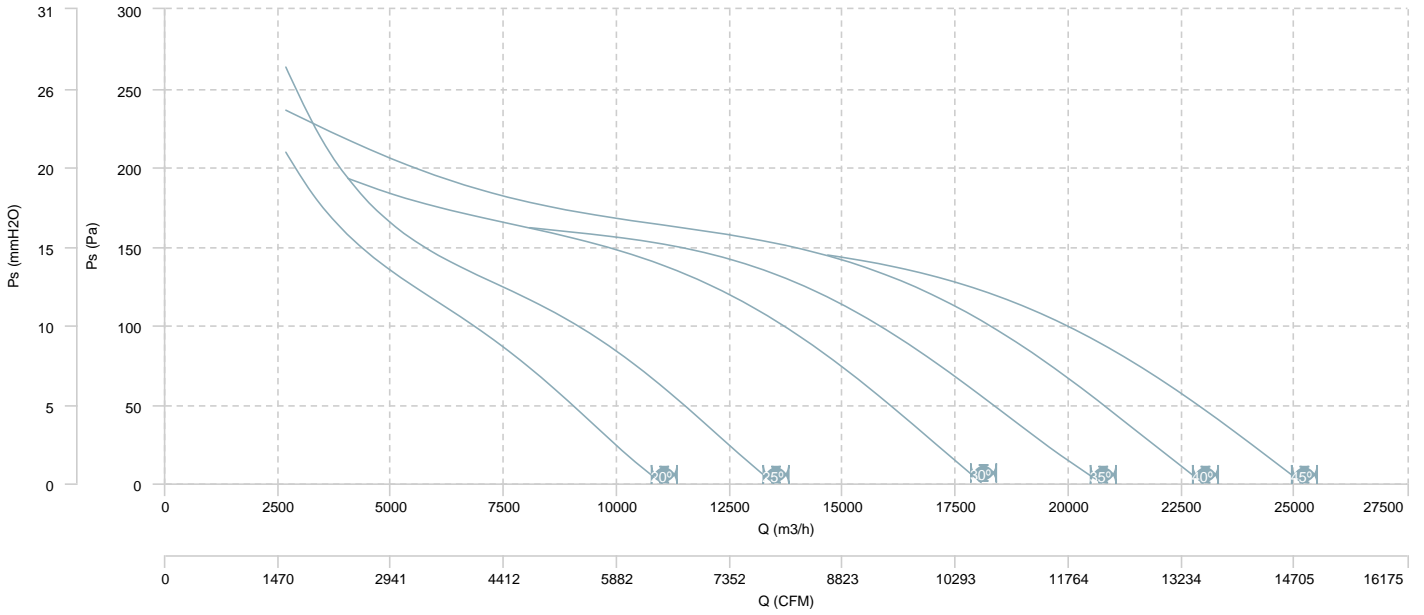

AIR FLOW - MECHANICAL POWER

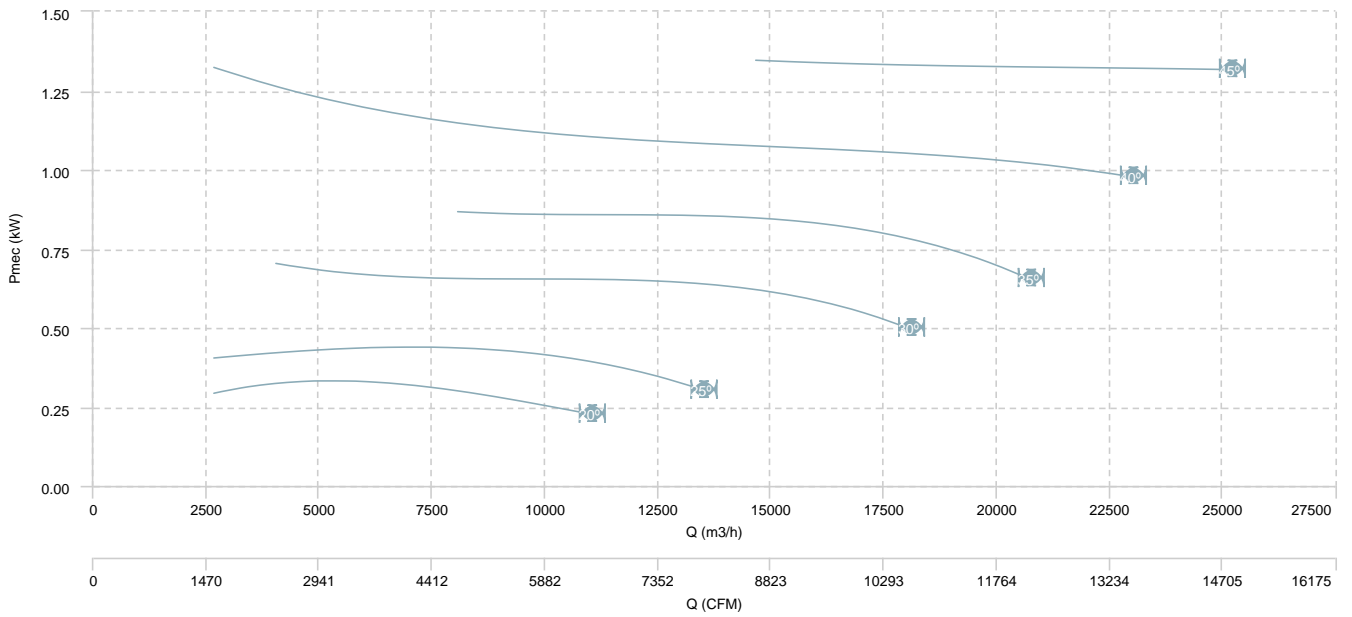

HB 80 T4/T8 (A2:6)

AIR FLOW - PRESSURE (4 poles)

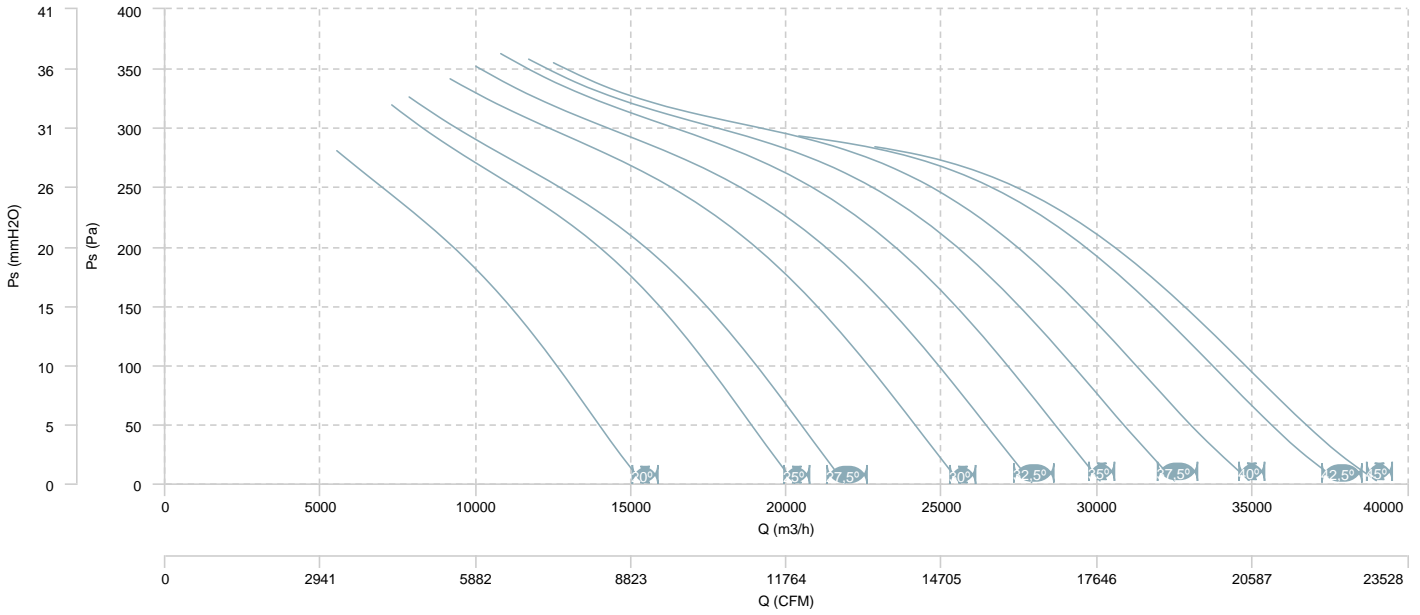

AIR FLOW - MECHANICAL POWER (4 poles)

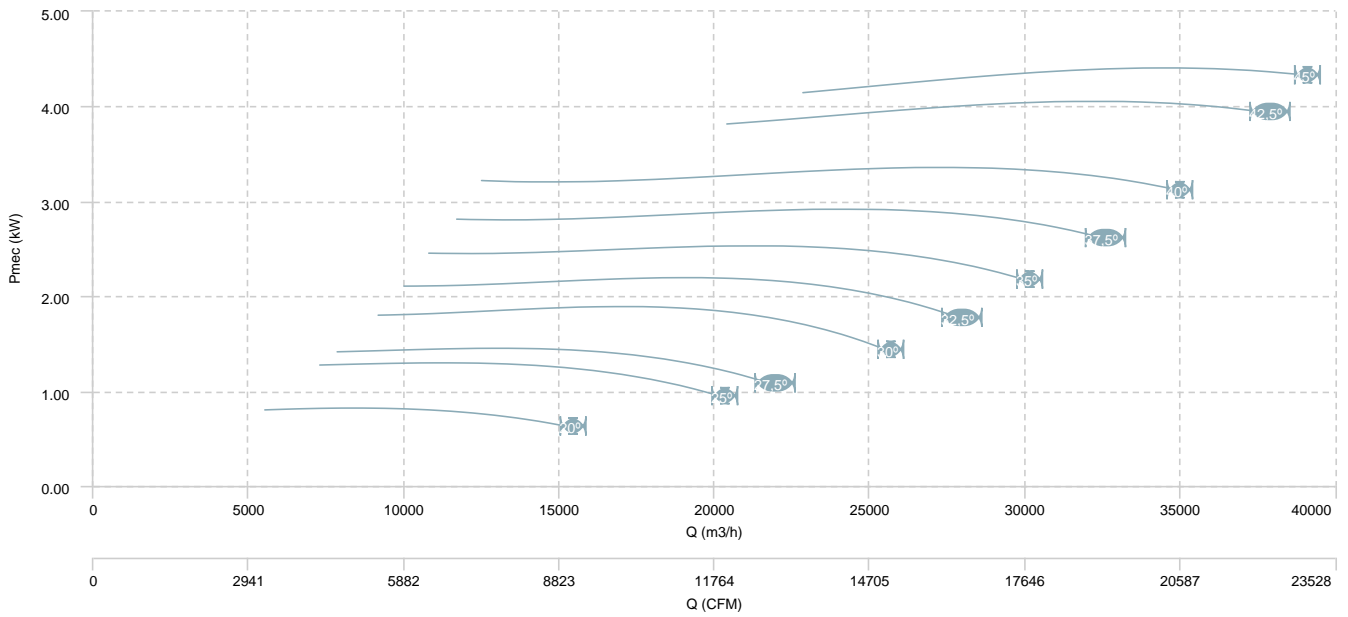

HB 80 T4/T8 (A2:6)

AIR FLOW - PRESSURE (8 poles)

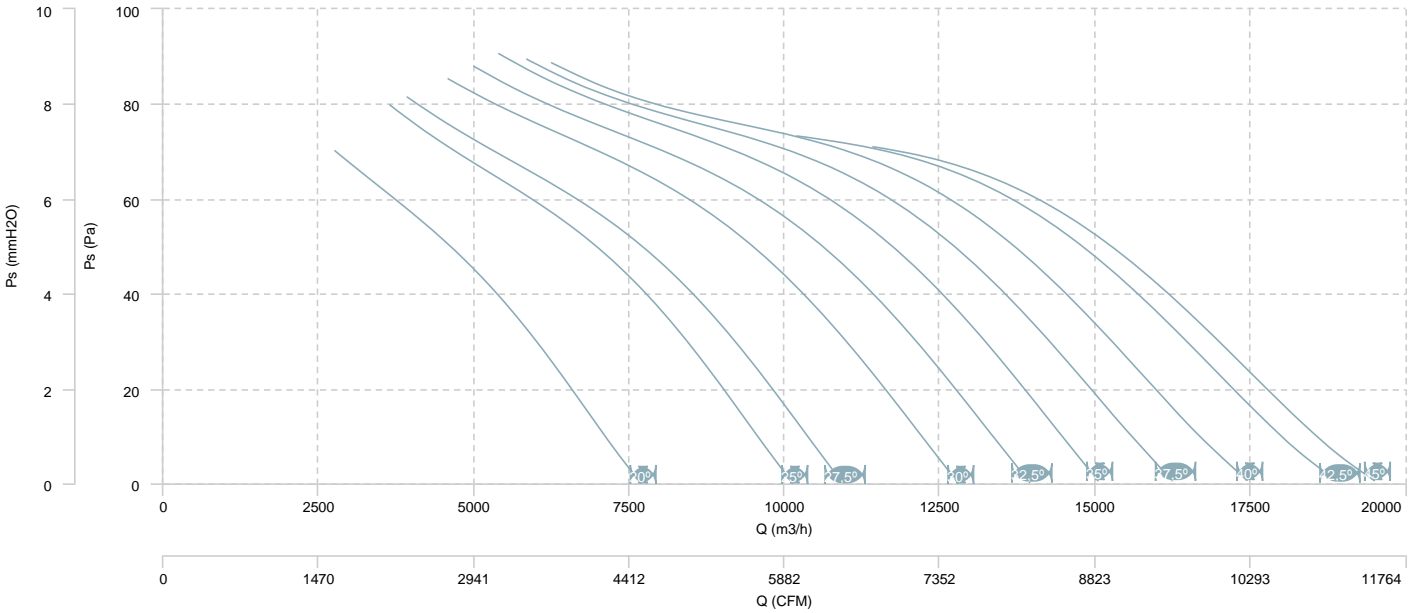

AIR FLOW - MECHANICAL POWER (8 poles)

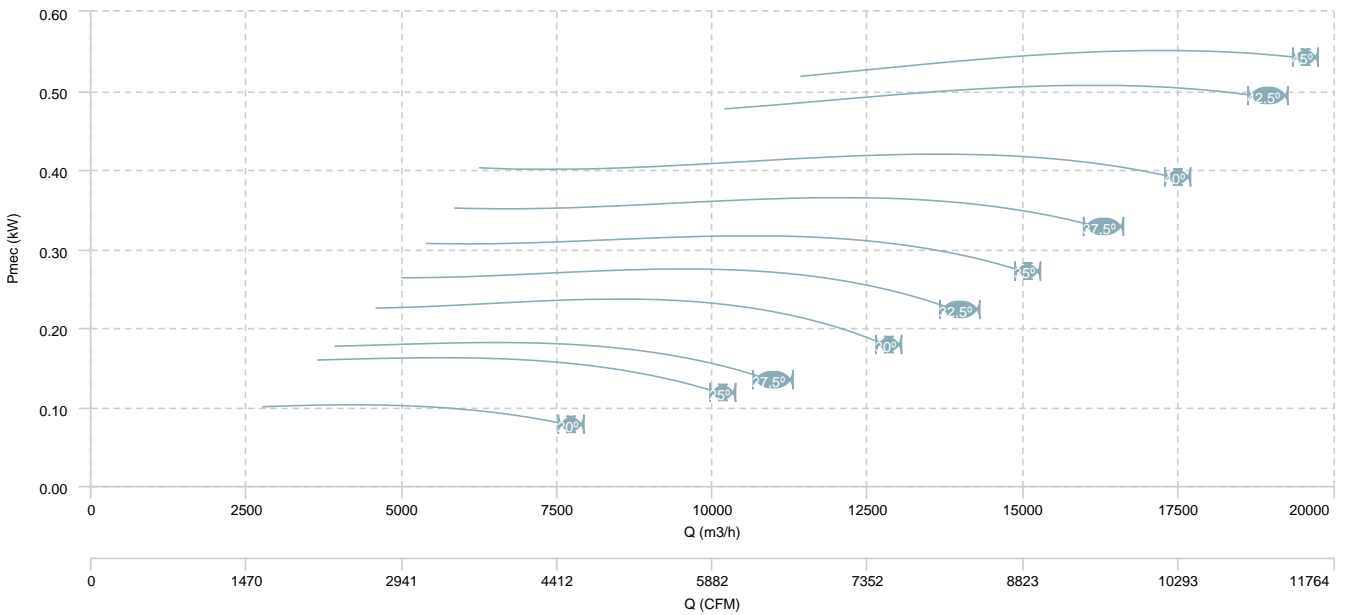

HB 80 T4/T8 (A2:9)

AIR FLOW - PRESSURE (4 poles)

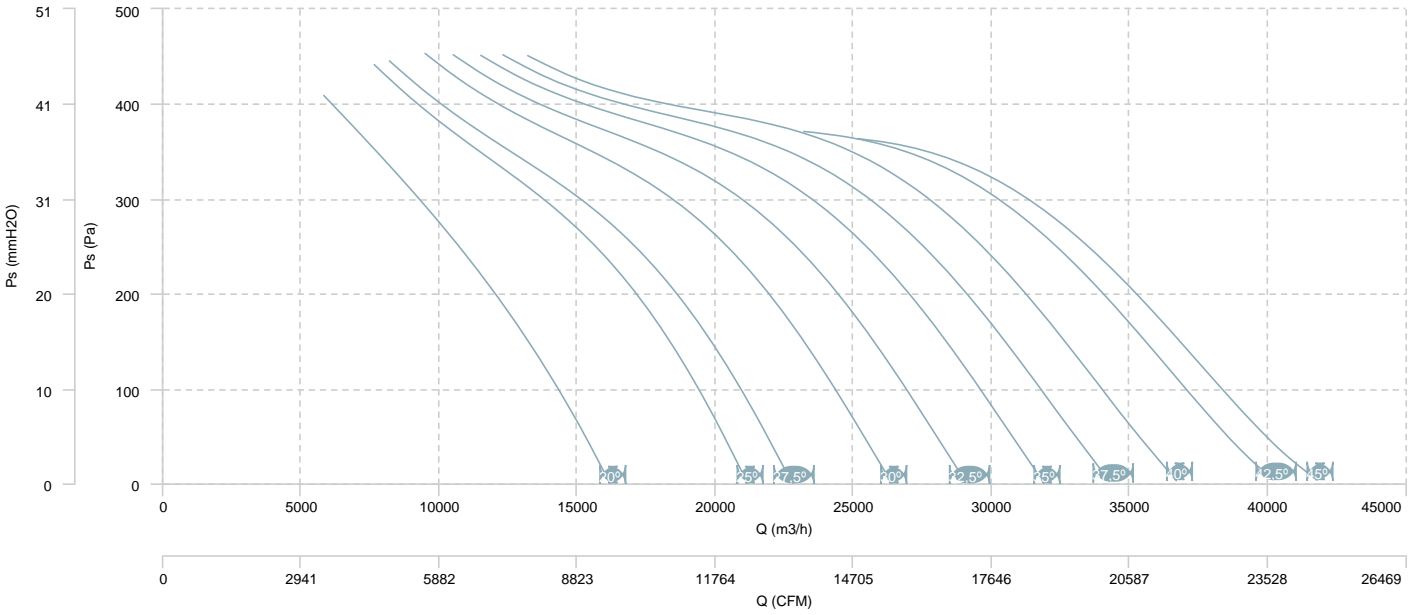

AIR FLOW - MECHANICAL POWER (4 poles)

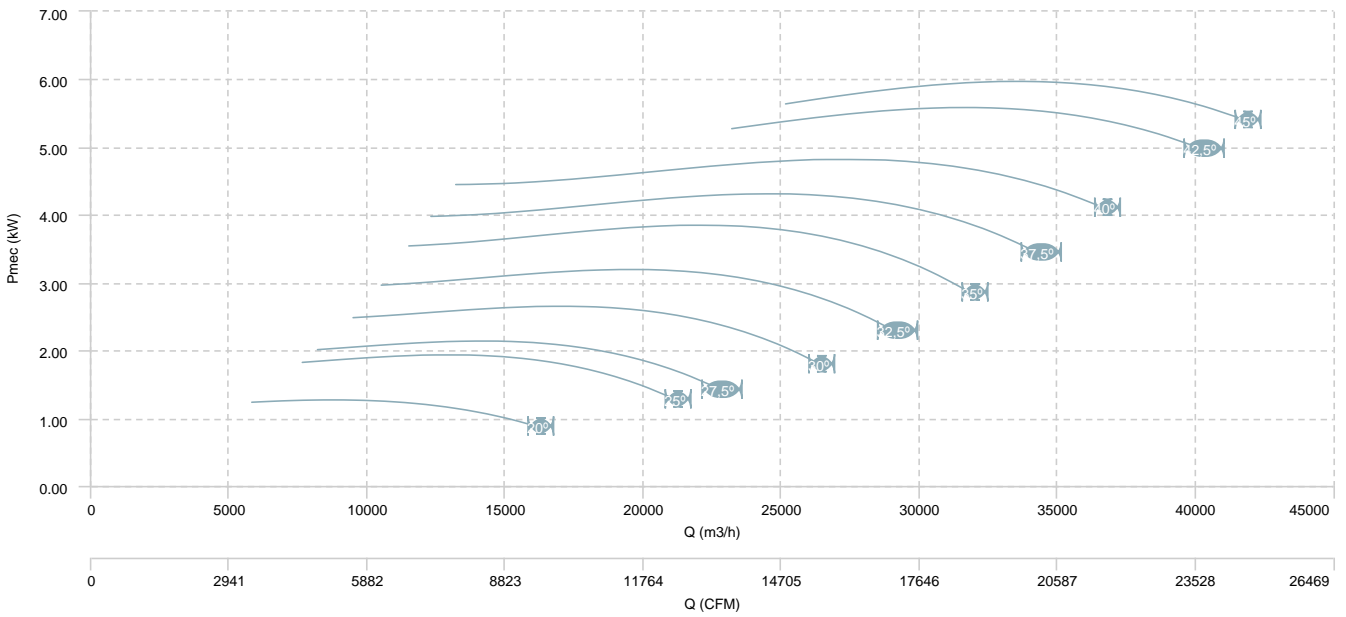

HB 80 T4/T8 (A2:9)

AIR FLOW - PRESSURE (8 poles)

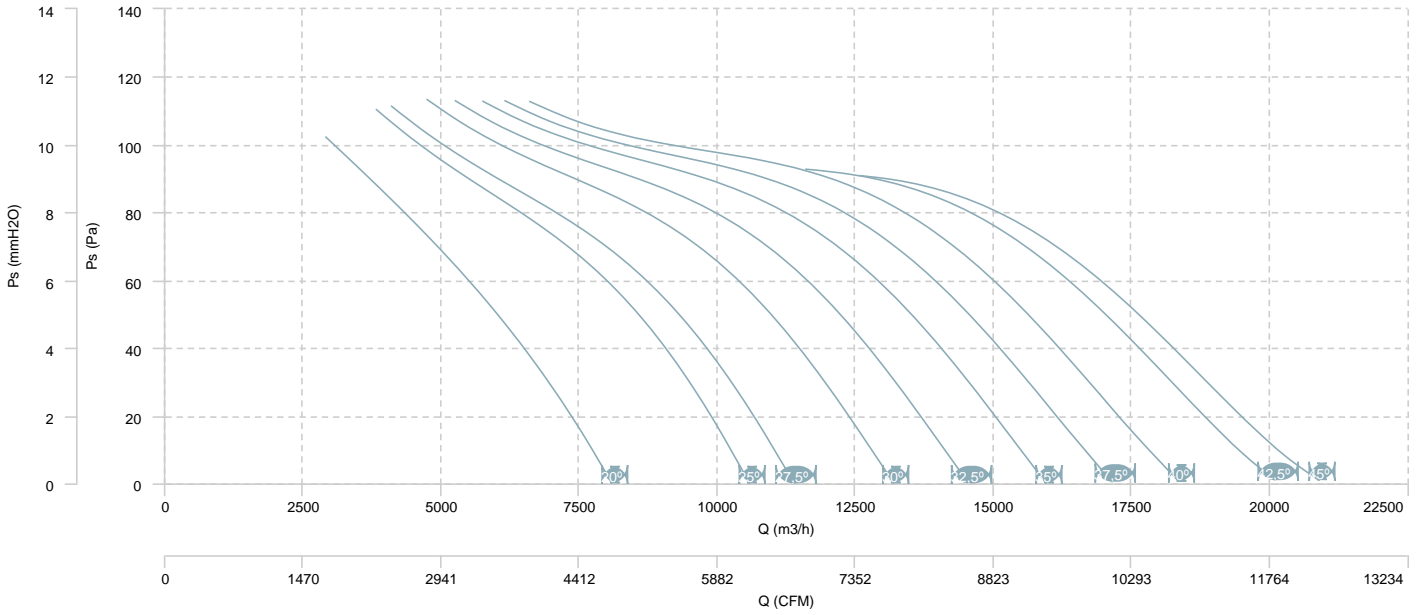

AIR FLOW - MECHANICAL POWER (8 poles)

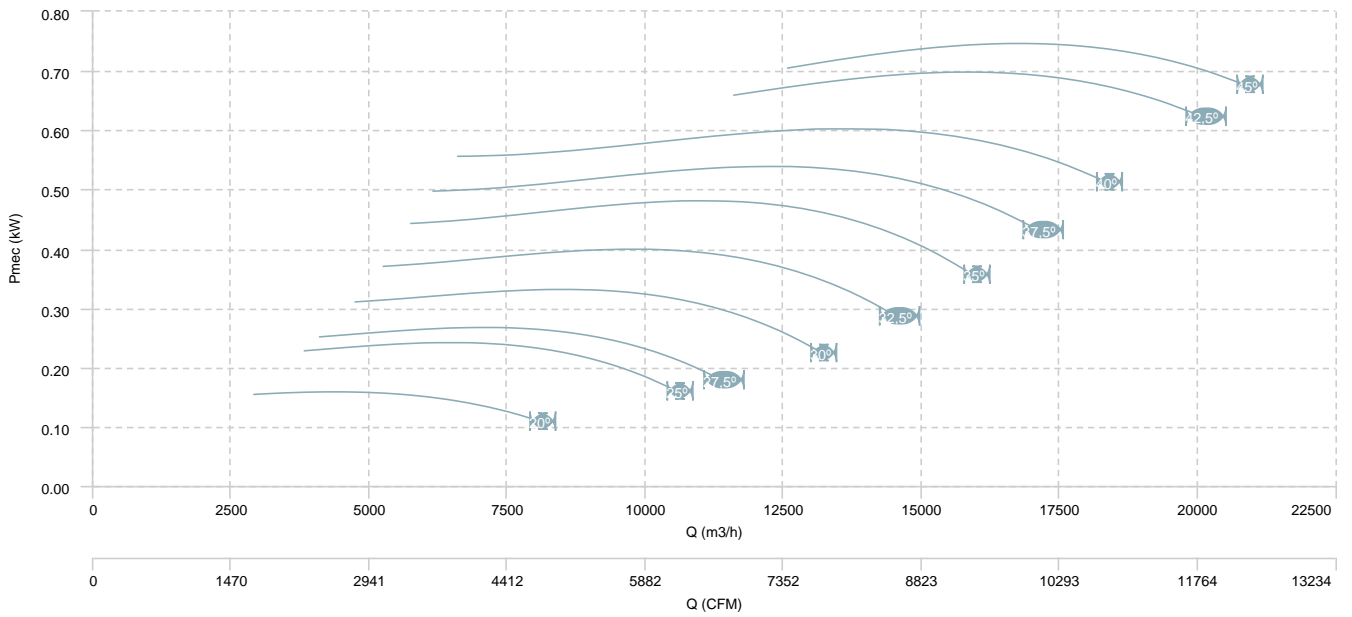

HB 80 T4/T8 (A5:6)

AIR FLOW - PRESSURE (4 poles)

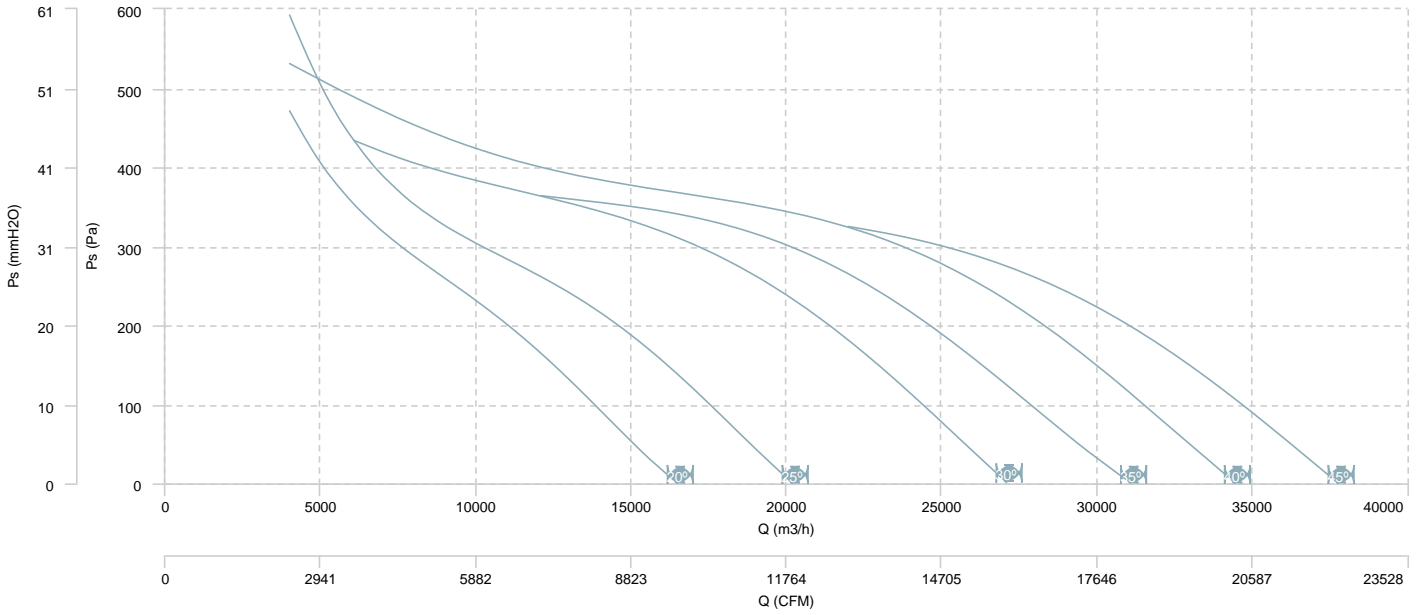

AIR FLOW - MECHANICAL POWER (4 poles)

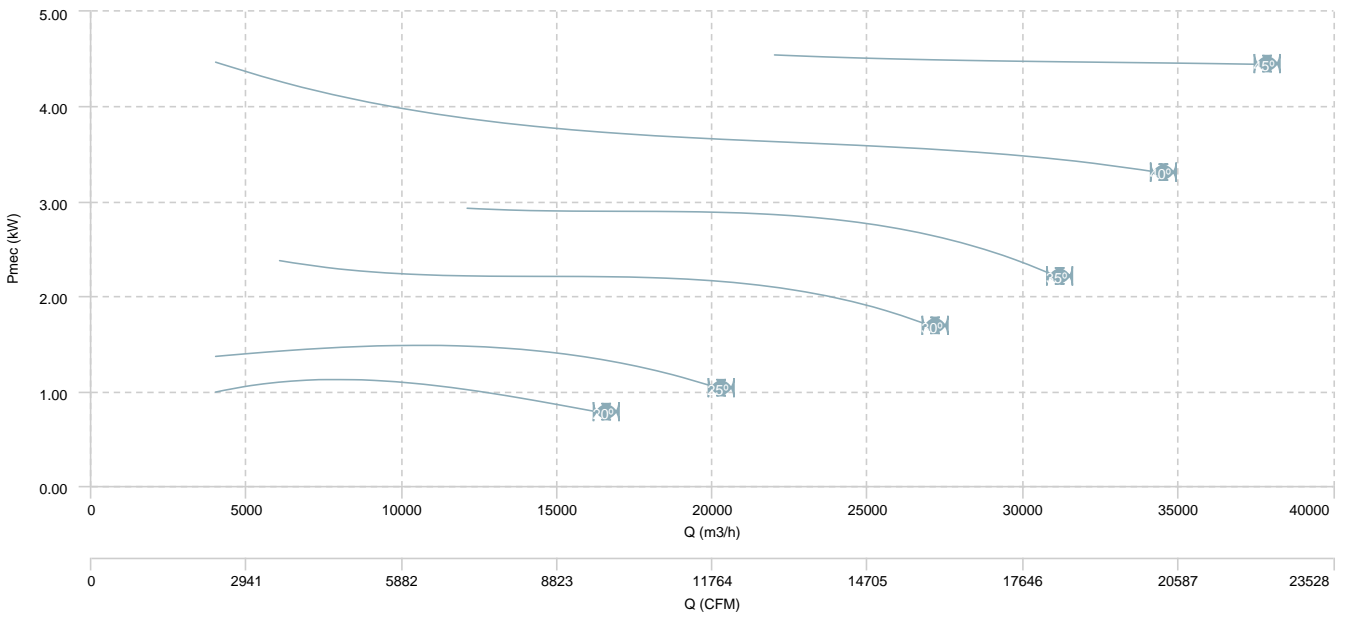

HB 80 T4/T8 (A5:6)

AIR FLOW - PRESSURE (8 poles)

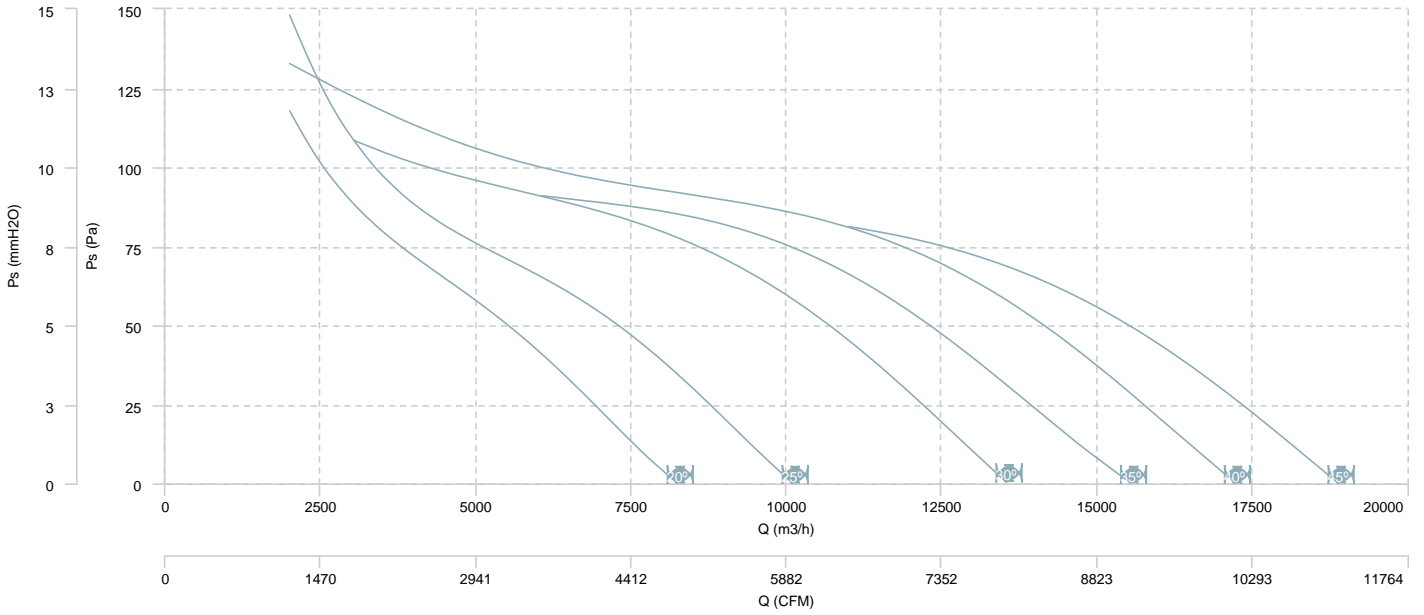

AIR FLOW - MECHANICAL POWER (8 poles)

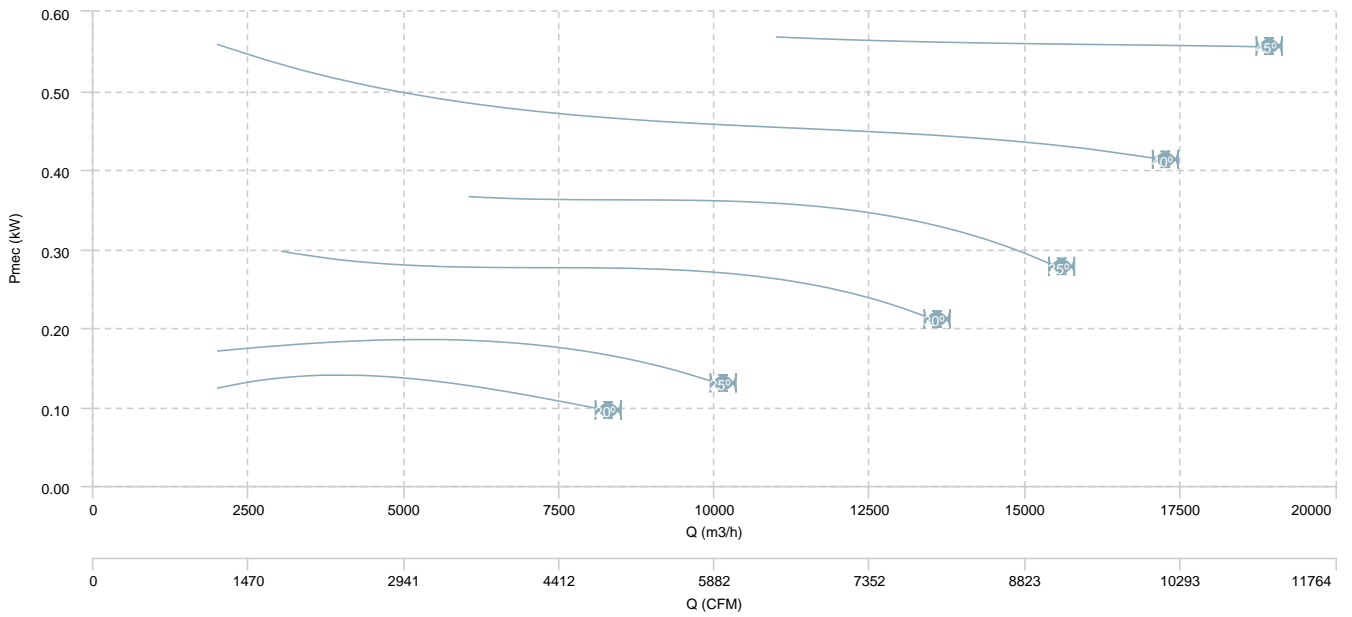

HB 90 T4 (A6:3)

AIR FLOW - PRESSURE

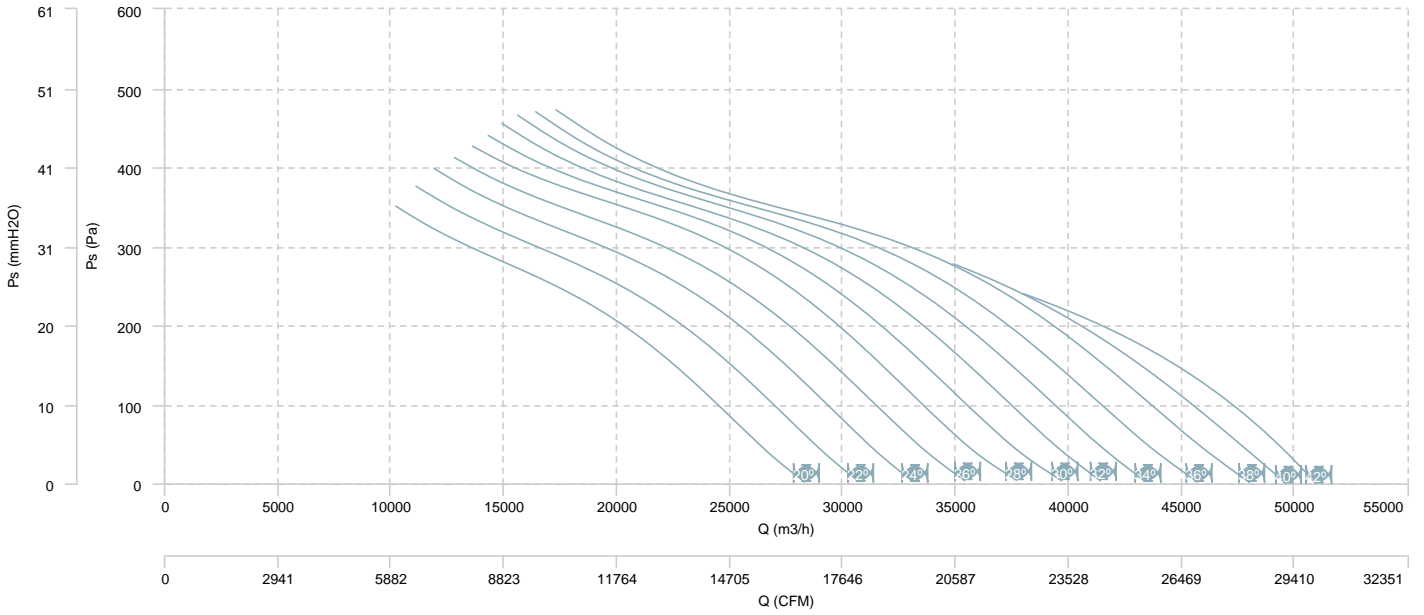

AIR FLOW - MECHANICAL POWER

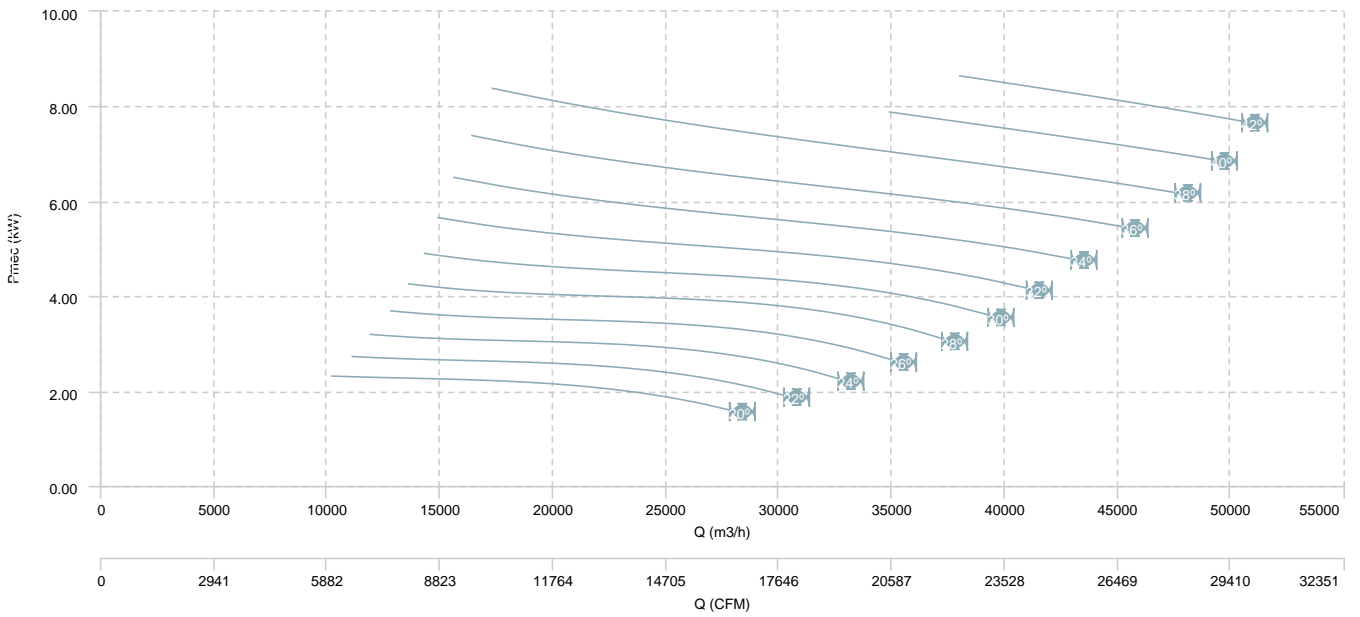

HB 90 T4 (A6:6)

AIR FLOW - PRESSURE

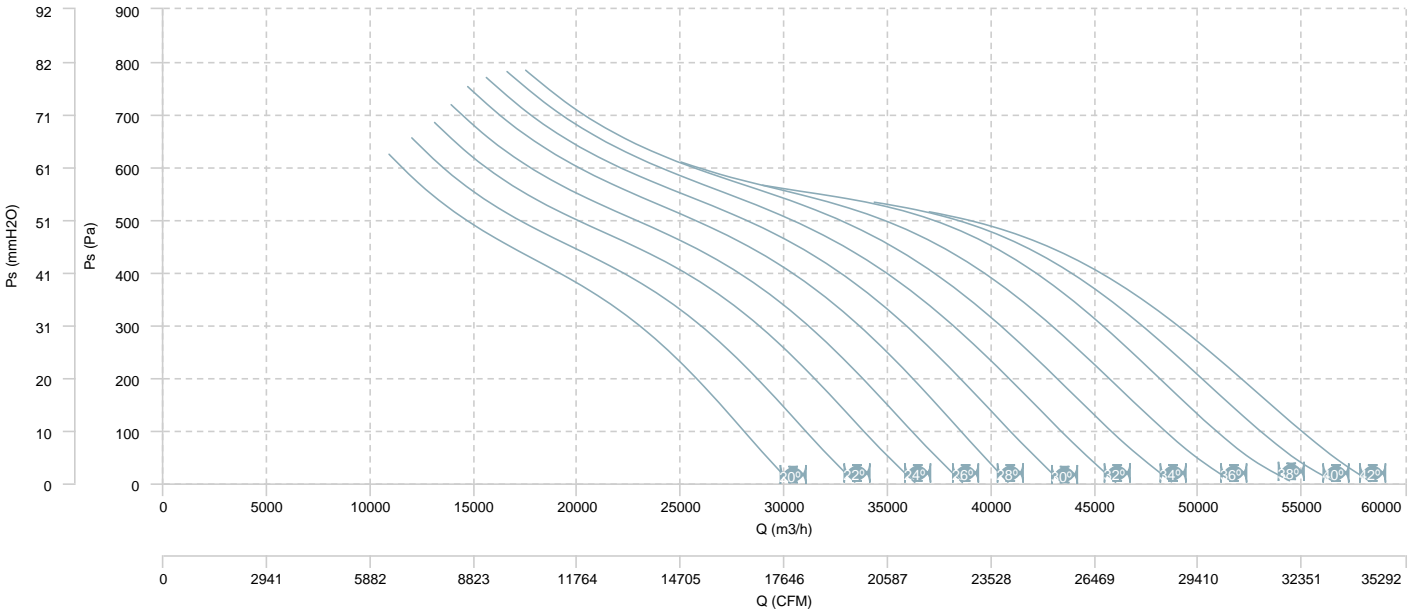

AIR FLOW - MECHANICAL POWER

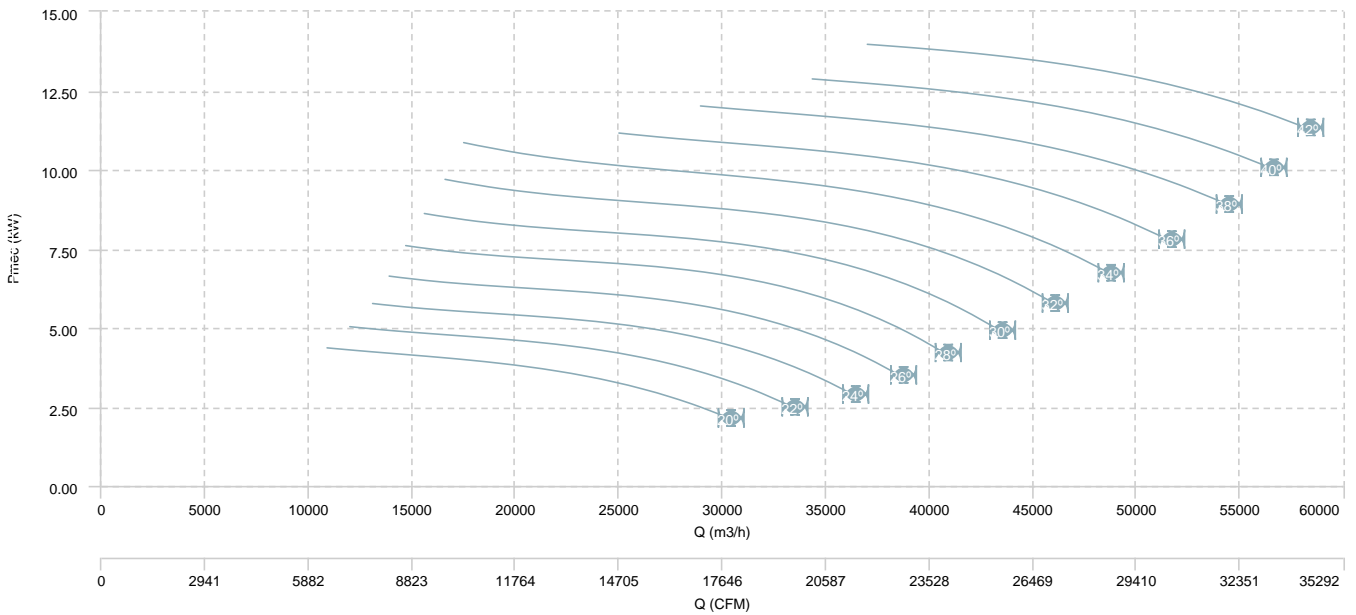

HB 90 T6 (A6:6)

AIR FLOW - PRESSURE

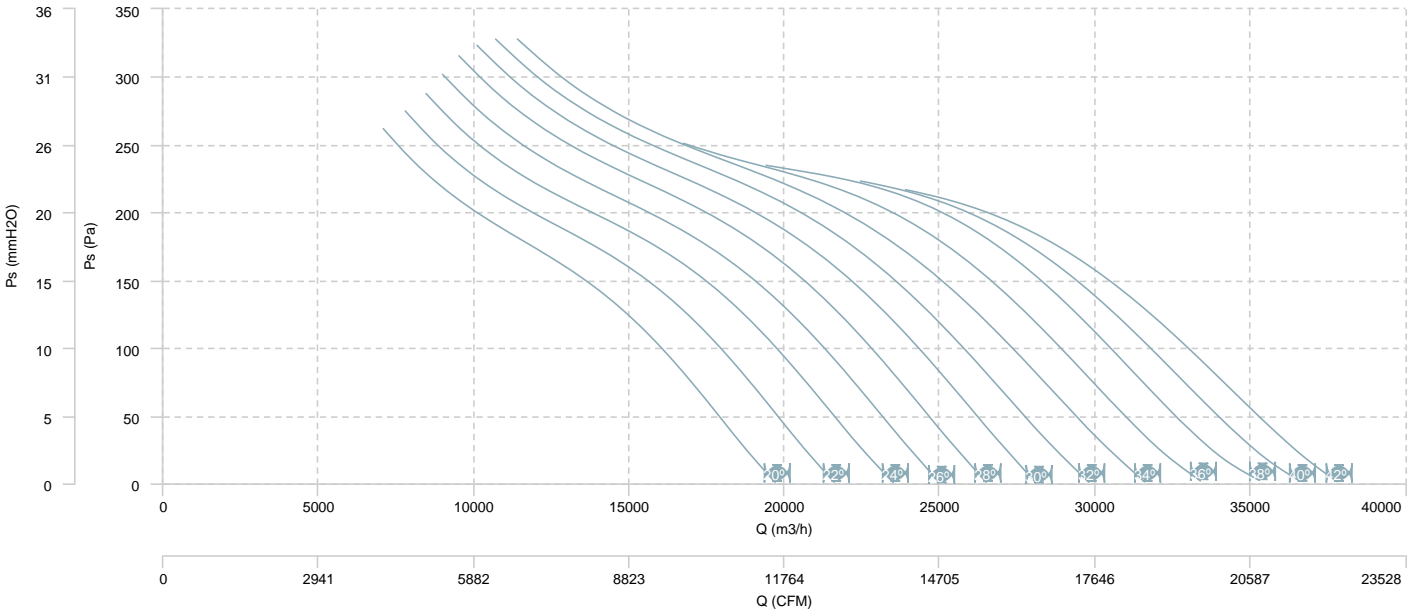

AIR FLOW - MECHANICAL POWER

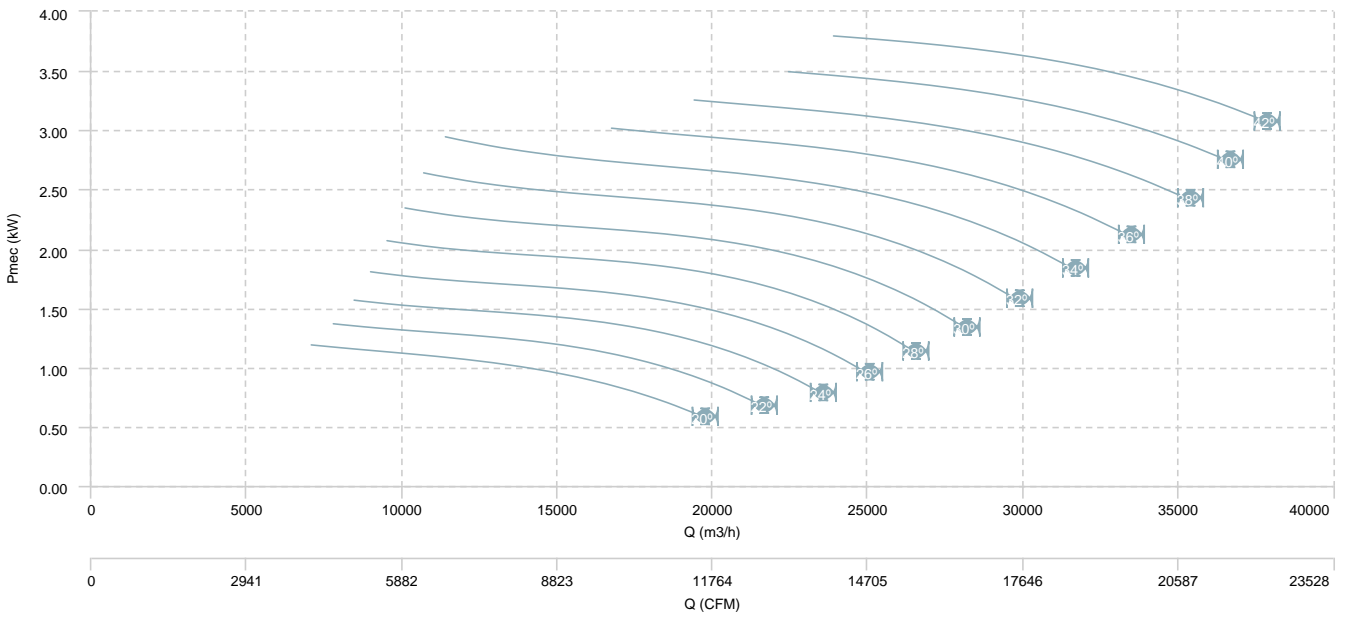

HB 90 T6 (A6:3)

AIR FLOW - PRESSURE

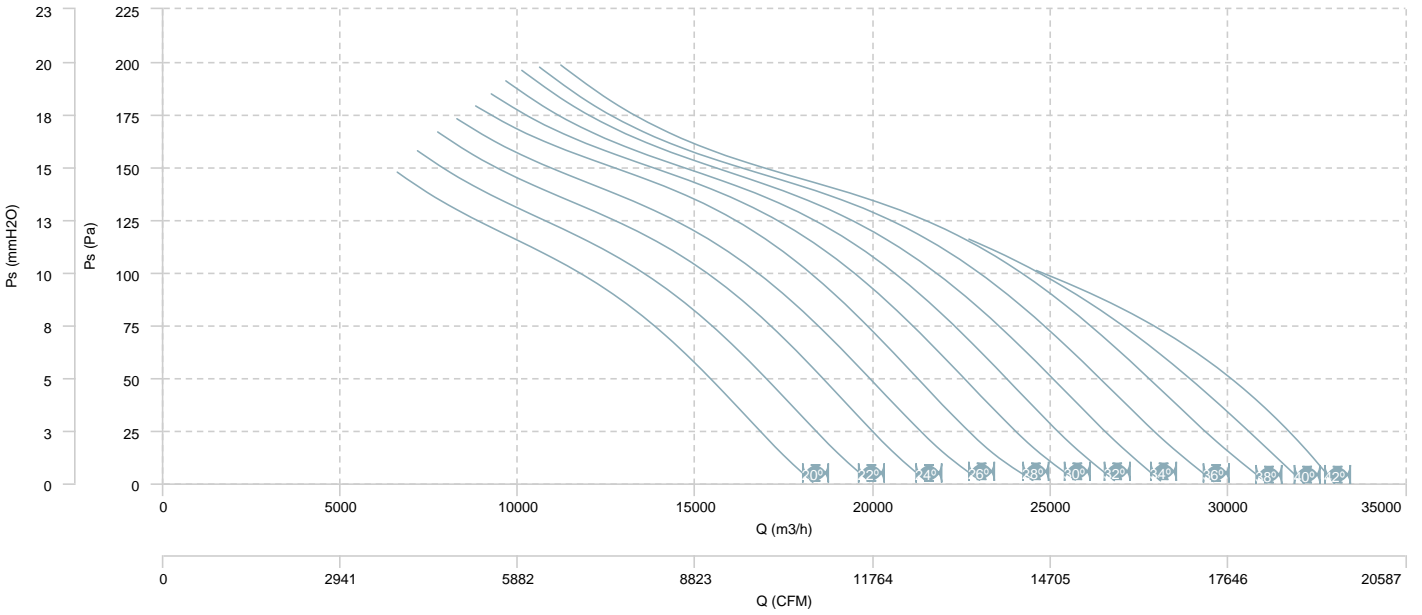

AIR FLOW - MECHANICAL POWER

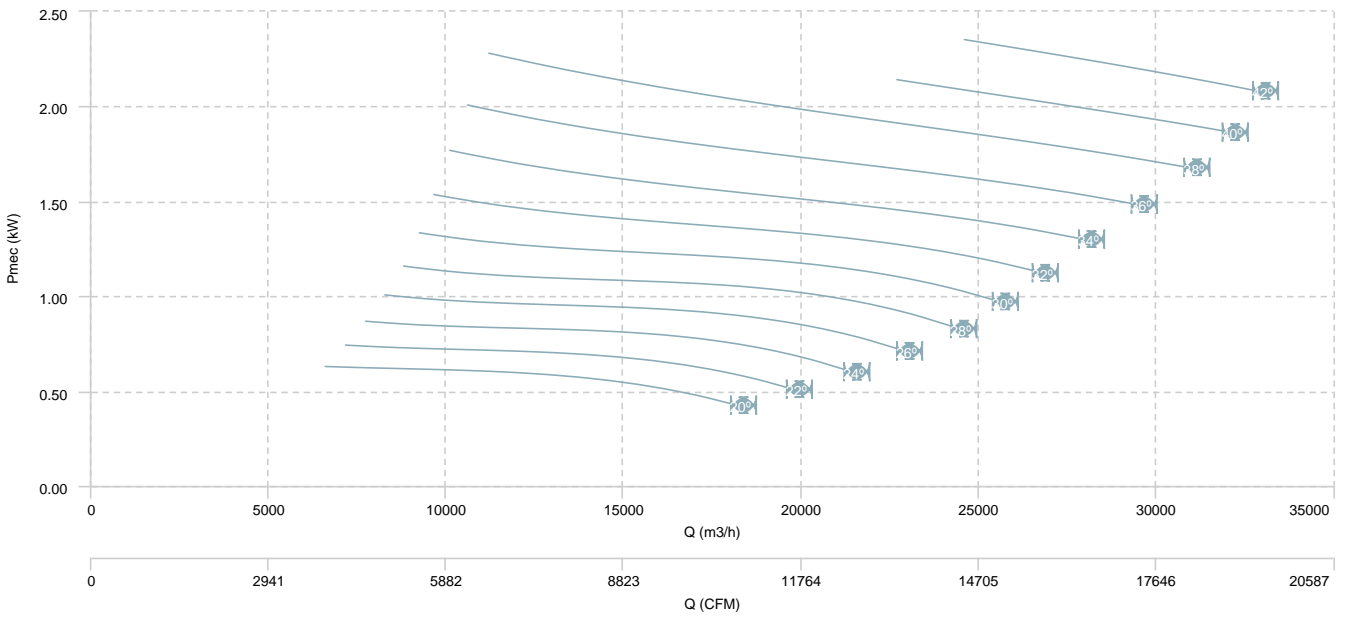

HB 90 T4/T8 (A6:3)

AIR FLOW - PRESSURE (4 poles)

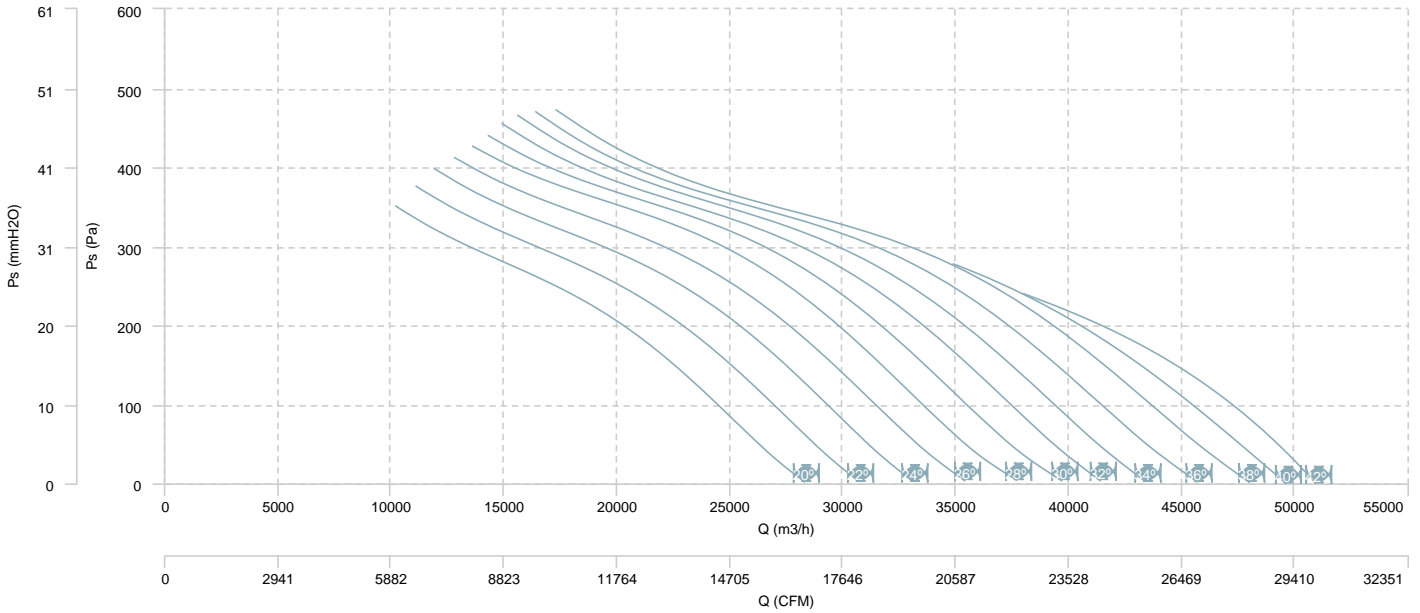

AIR FLOW - MECHANICAL POWER (4 poles)

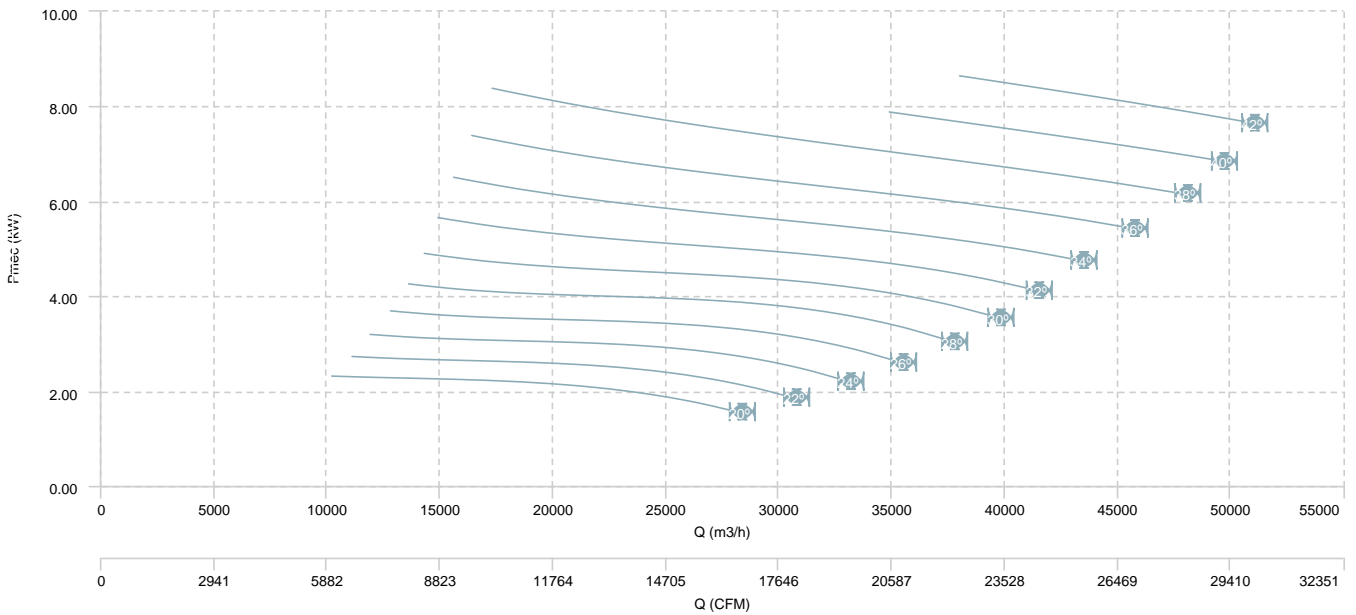

HB 90 T4/T8 (A6:3)

AIR FLOW - PRESSURE (8 poles)

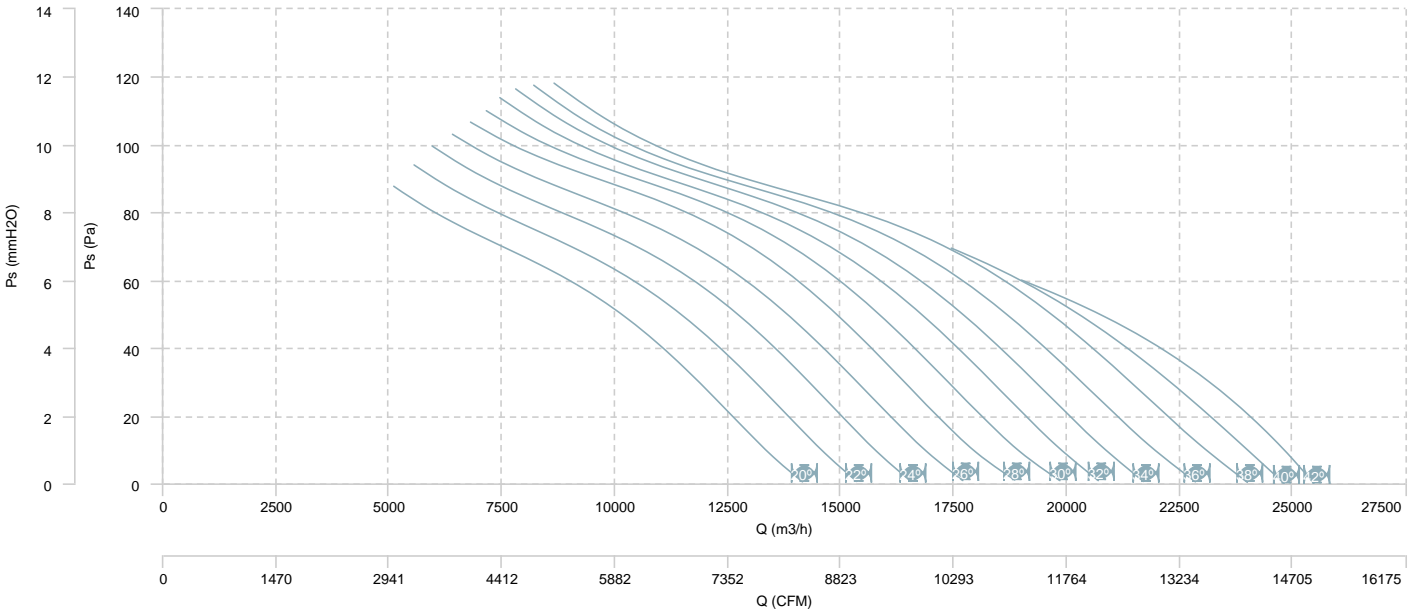

AIR FLOW - MECHANICAL POWER (8 poles)

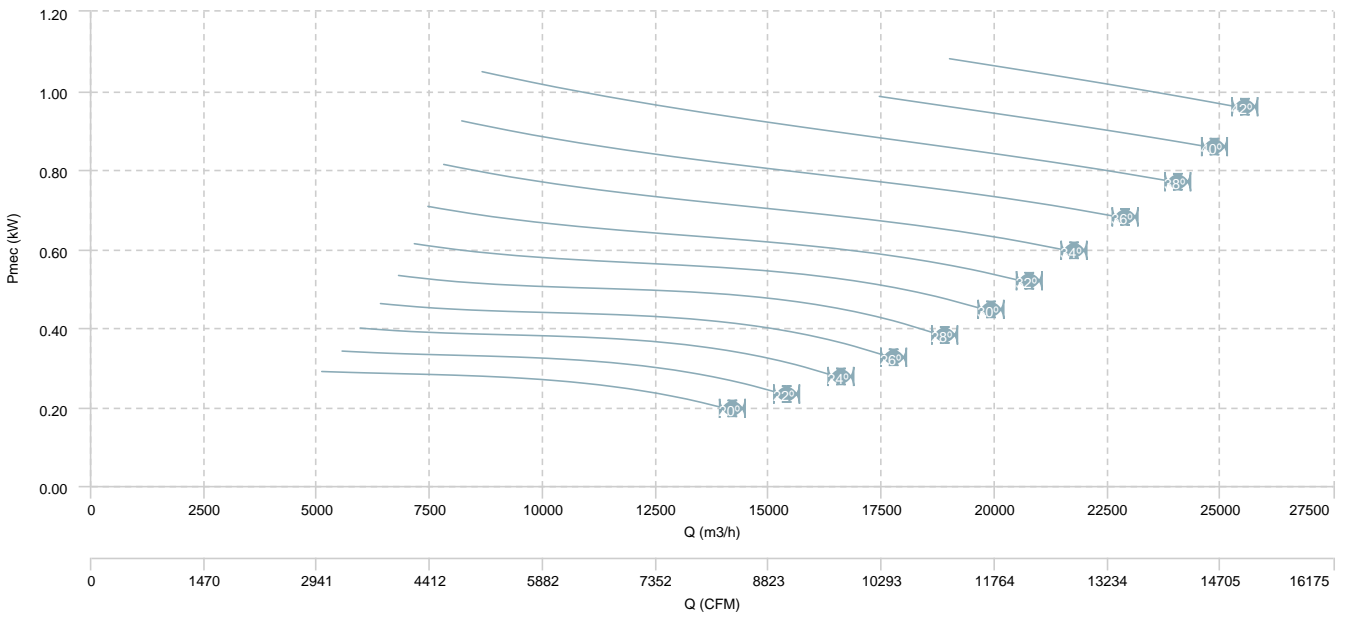

HB 90 T4/T8 (A6:6)

AIR FLOW - PRESSURE (4 poles)

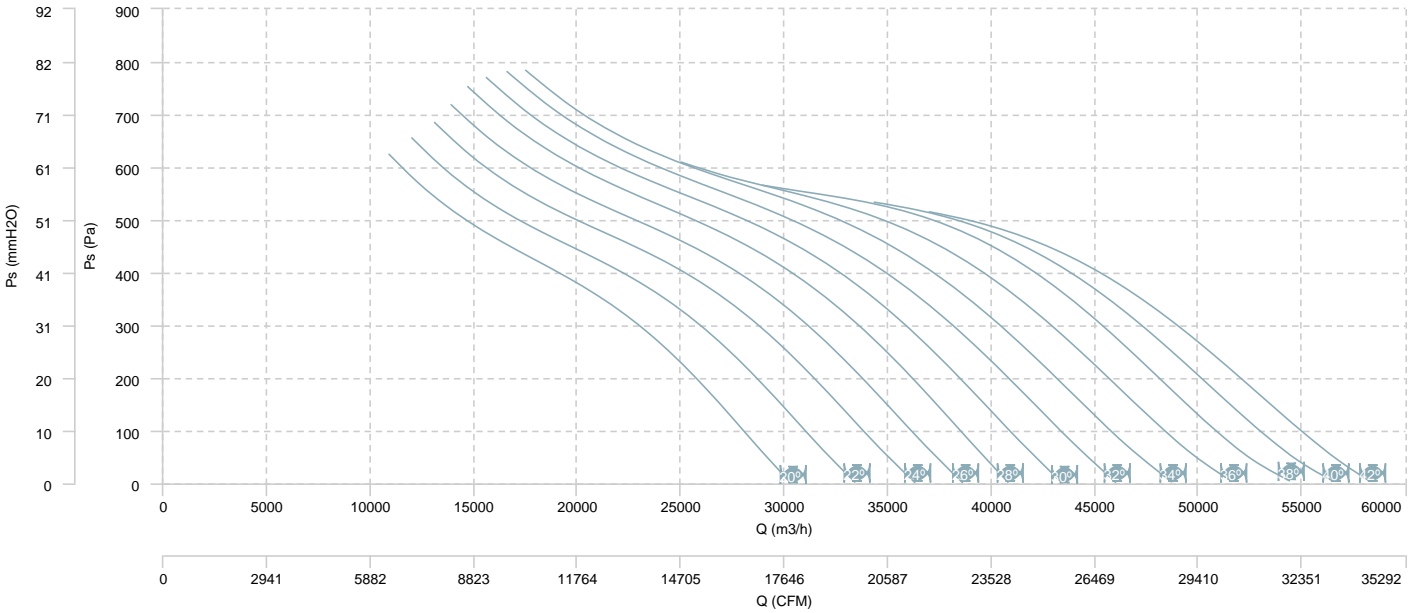

AIR FLOW - MECHANICAL POWER (4 poles)

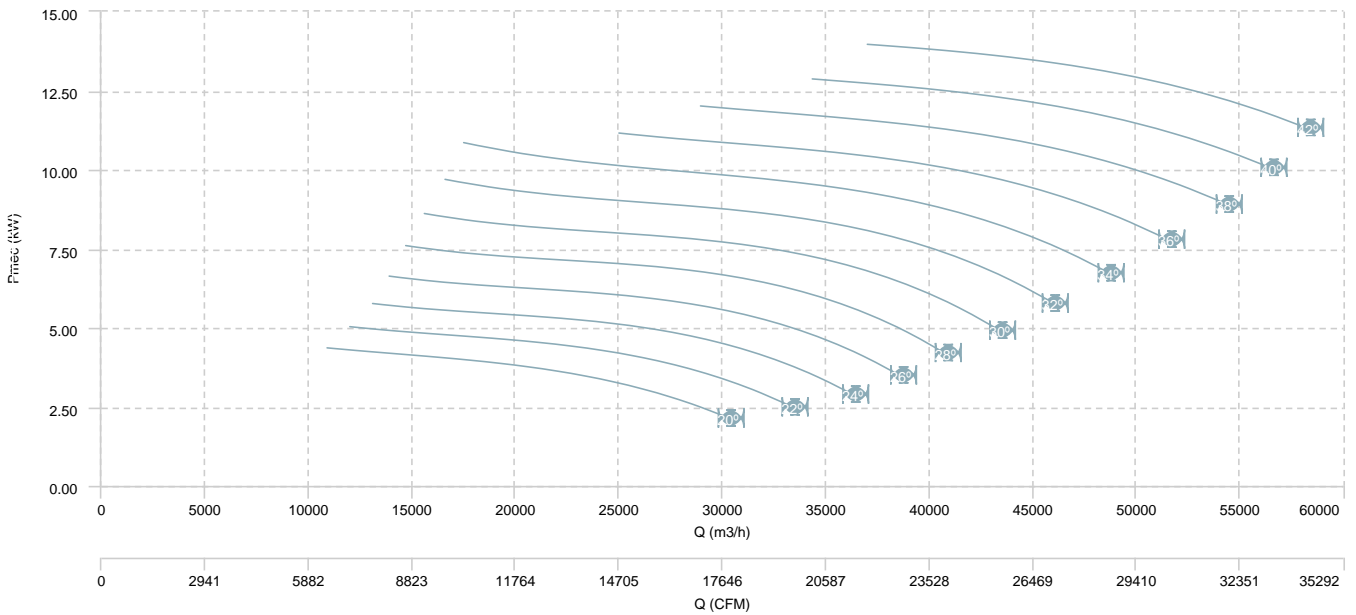

HB 90 T4/T8 (A6:6)

AIR FLOW - PRESSURE (8 poles)

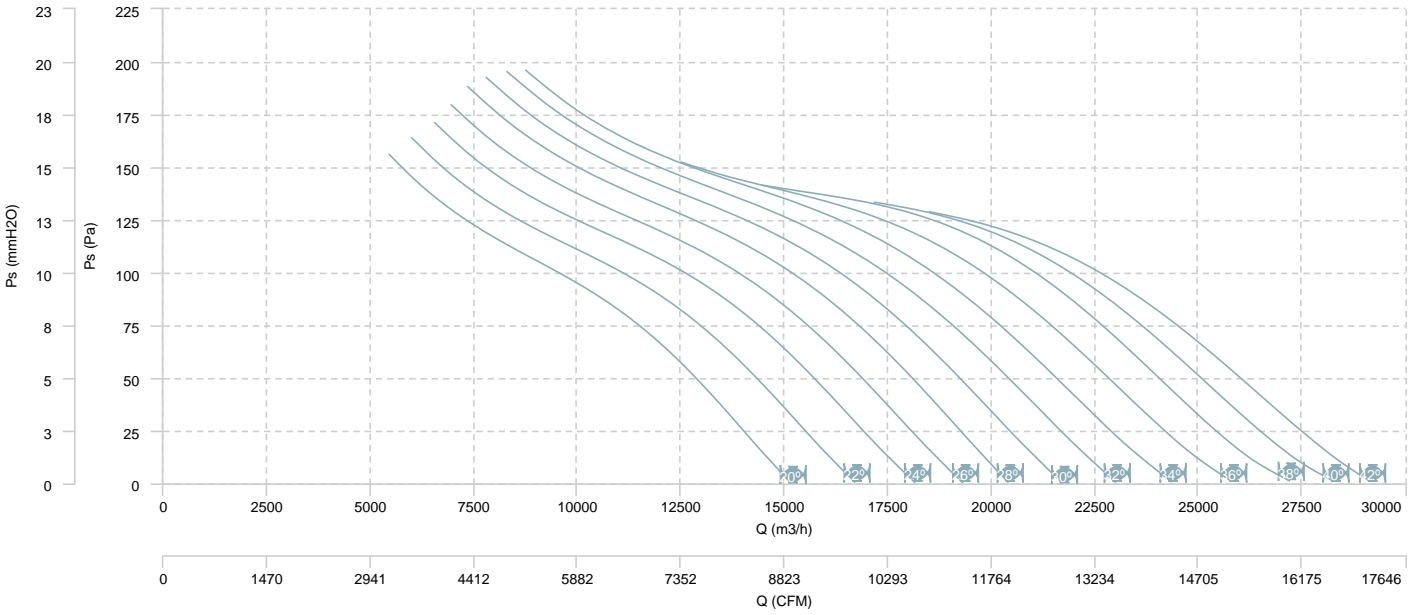

AIR FLOW - MECHANICAL POWER (8 poles)

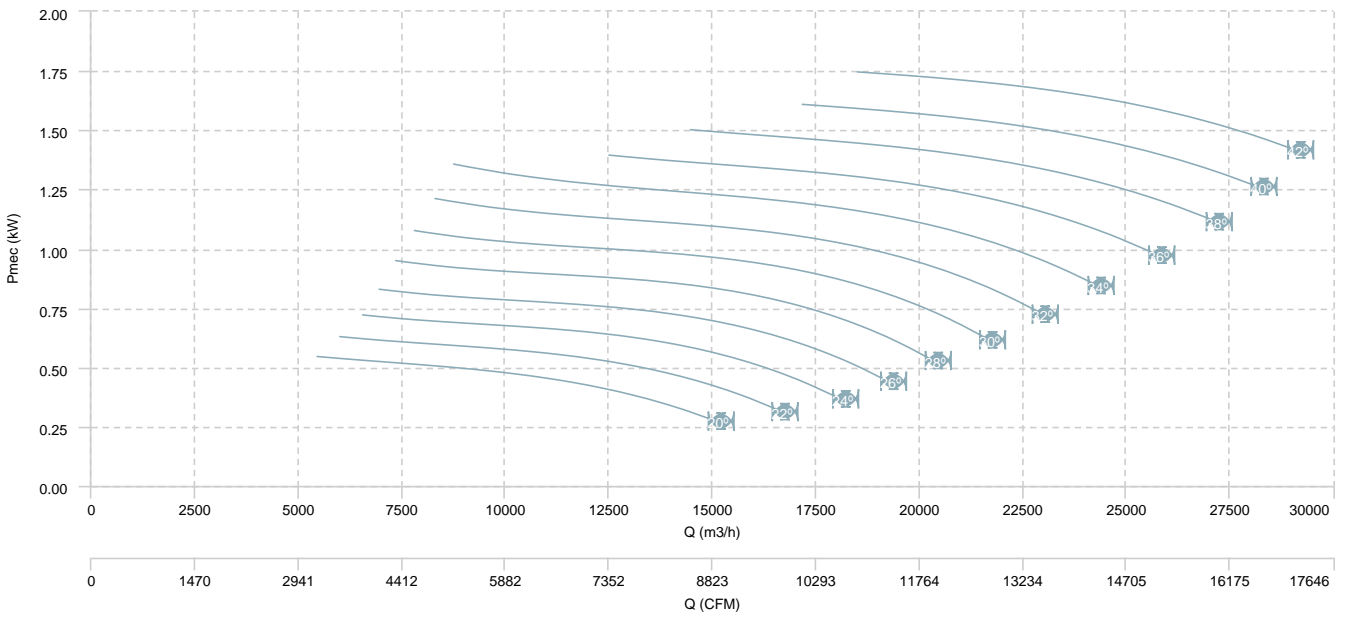

HB 100 T4 (A6:3)

AIR FLOW - PRESSURE

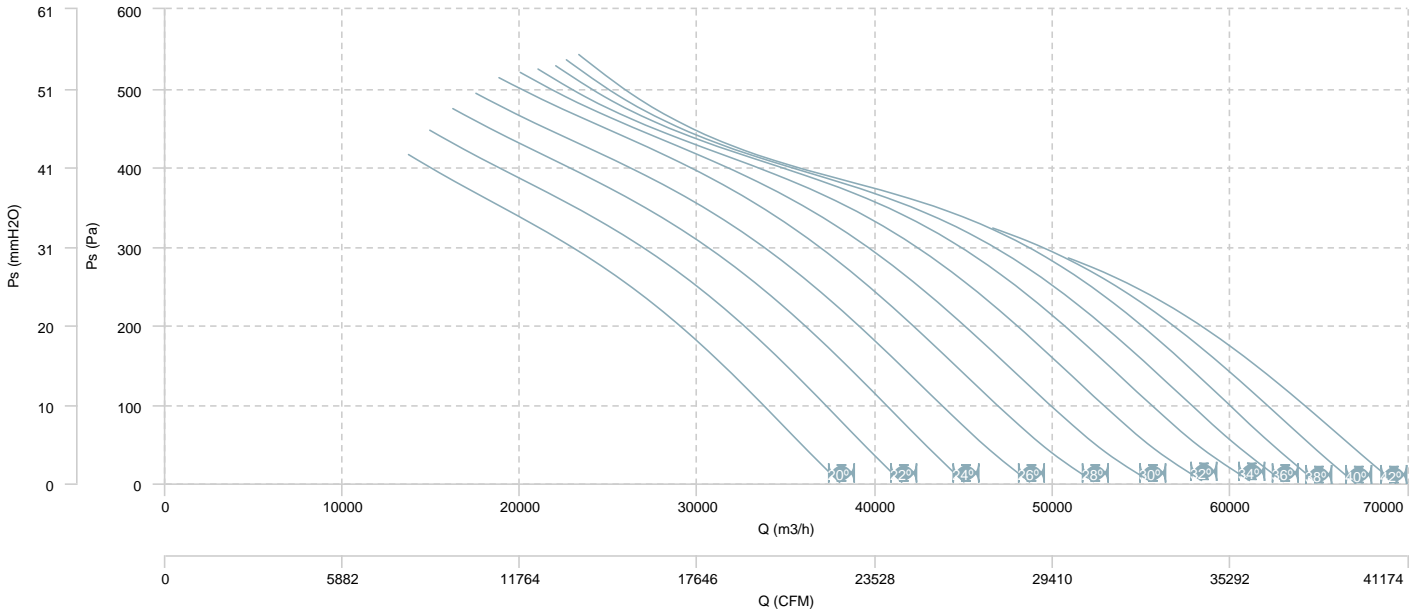

AIR FLOW - MECHANICAL POWER

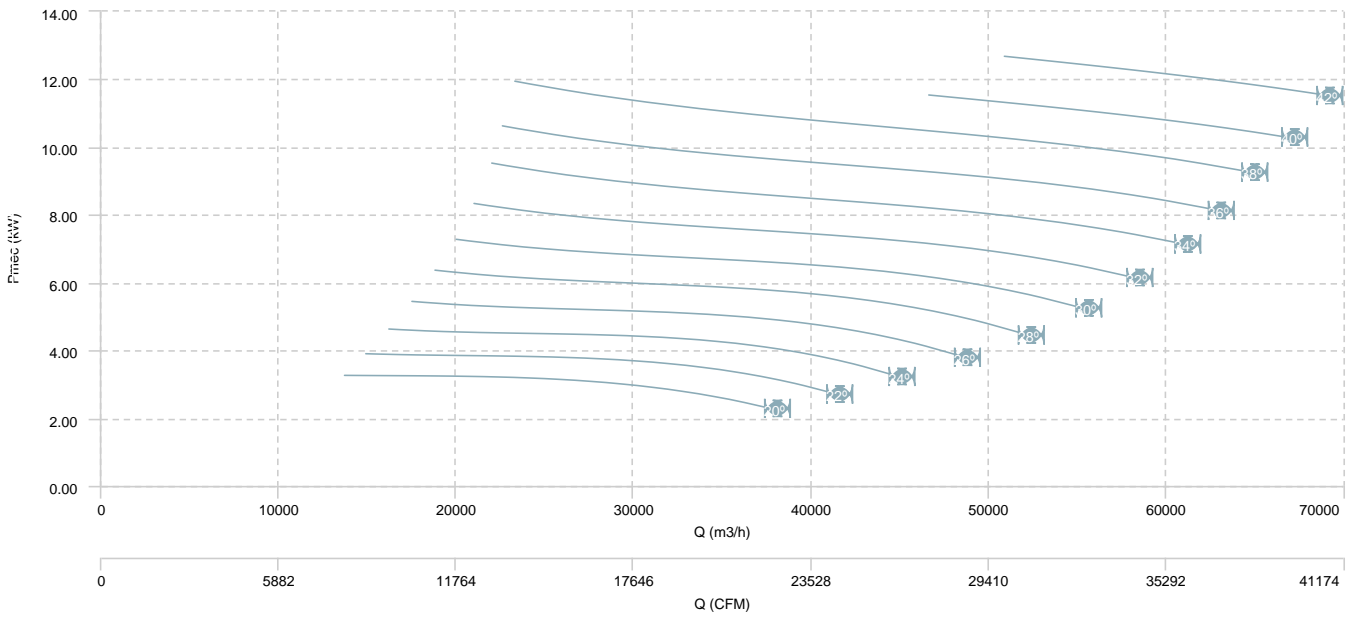

HB 100 T4 (A6:6)

AIR FLOW - PRESSURE

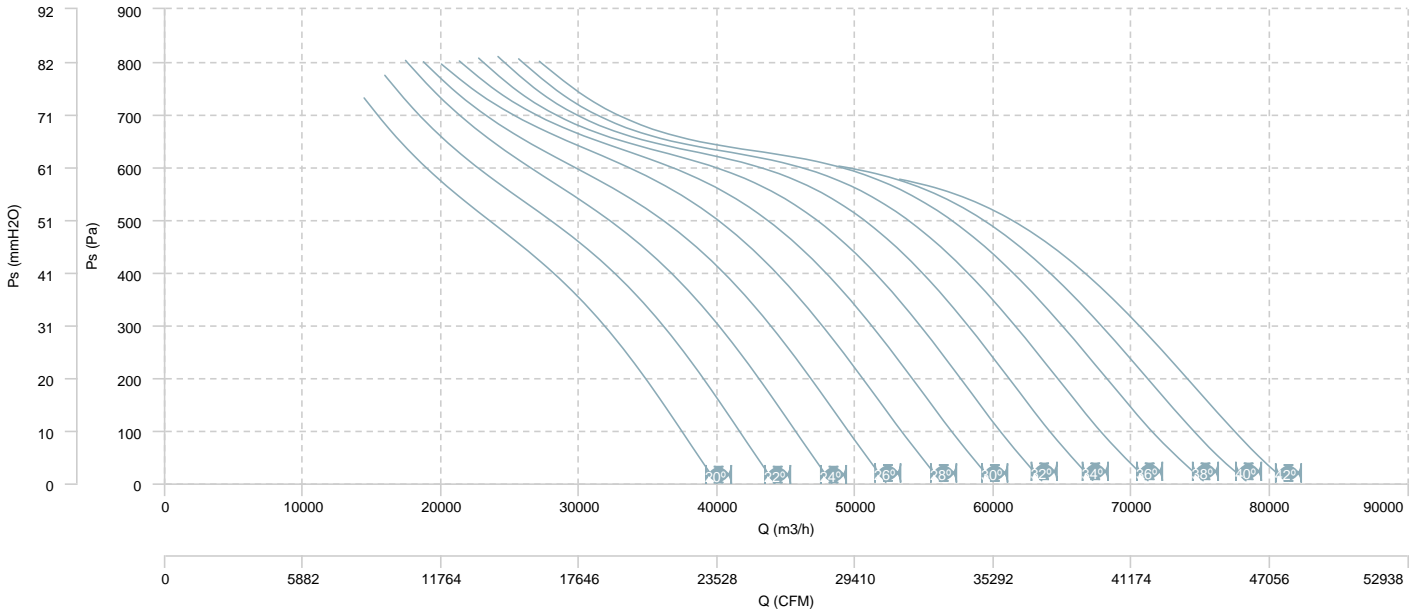

AIR FLOW - MECHANICAL POWER

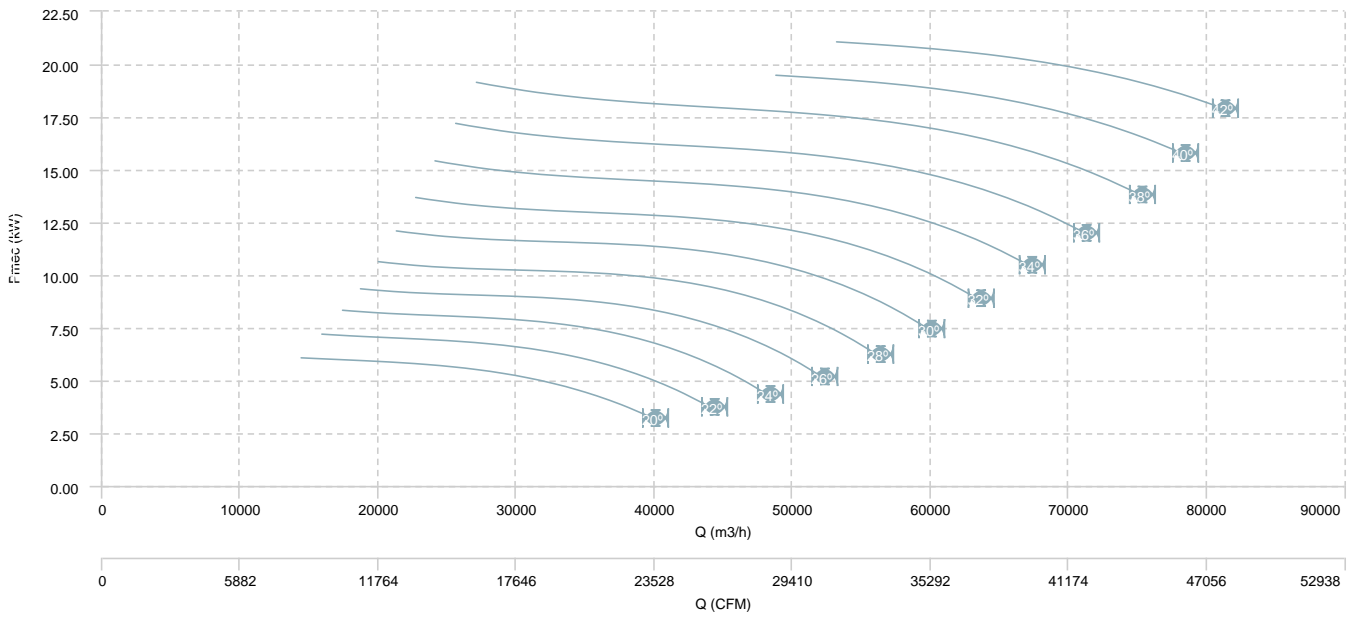

HB 100 T6 (A6:3)

AIR FLOW - PRESSURE

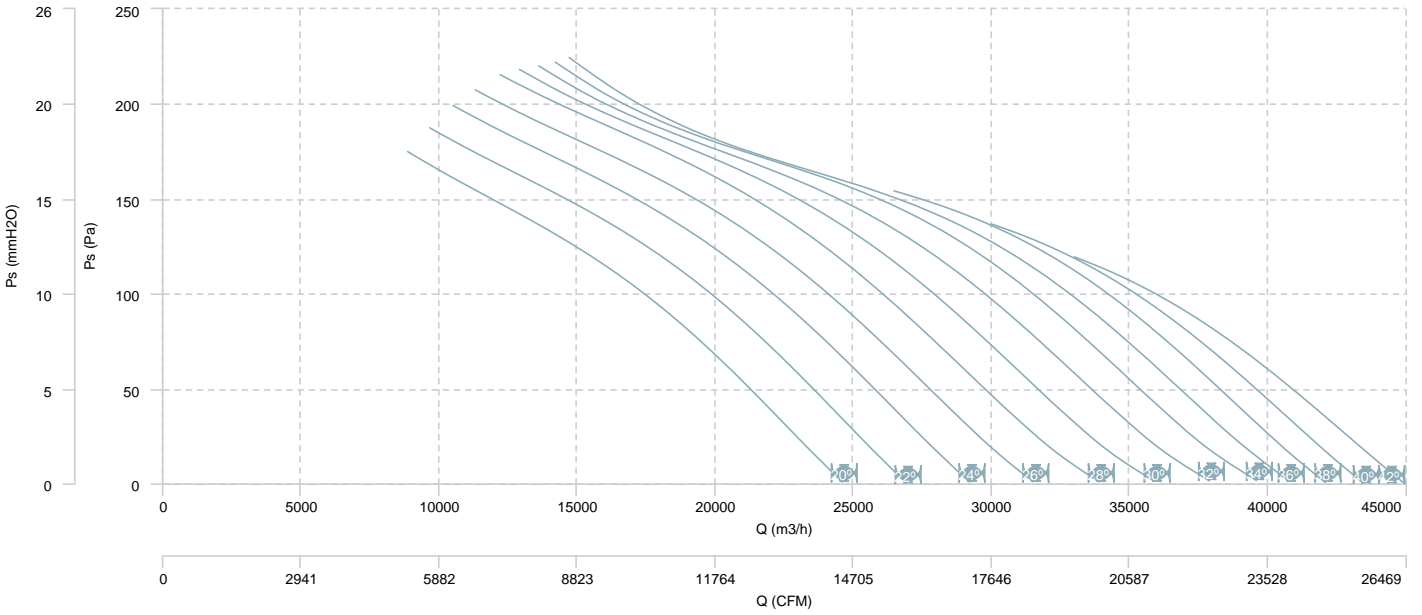

AIR FLOW - MECHANICAL POWER

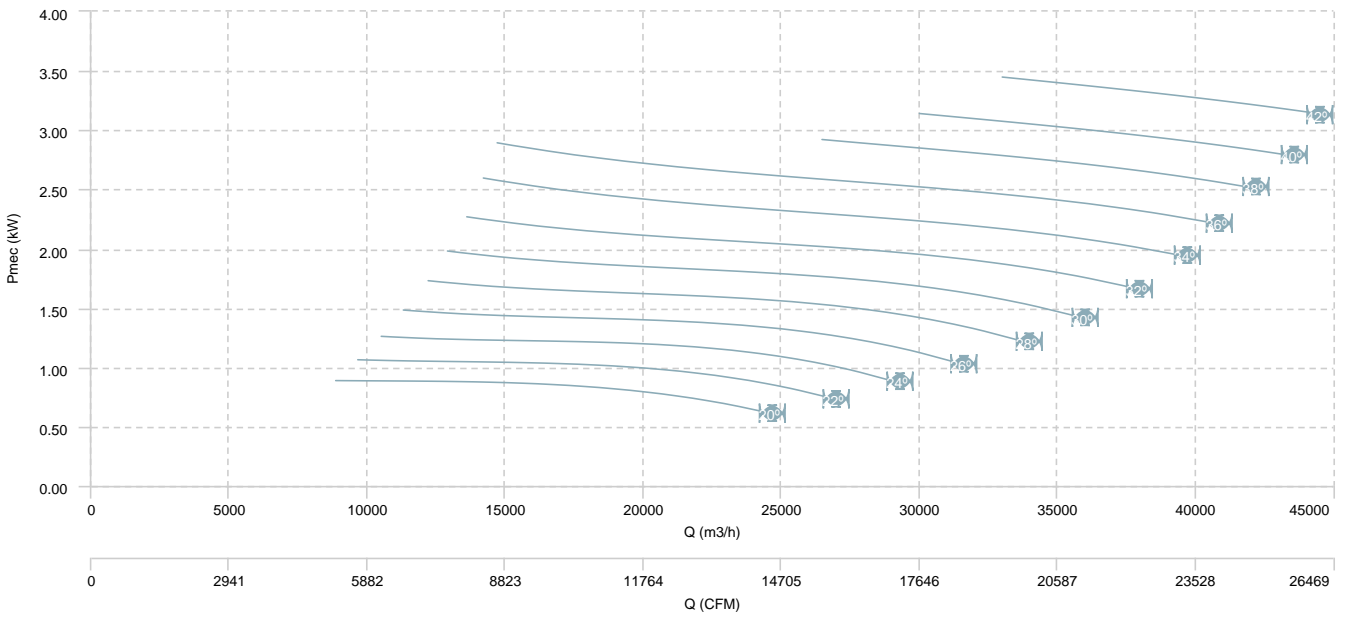

HB 100 T6 (A6:6)

AIR FLOW - PRESSURE

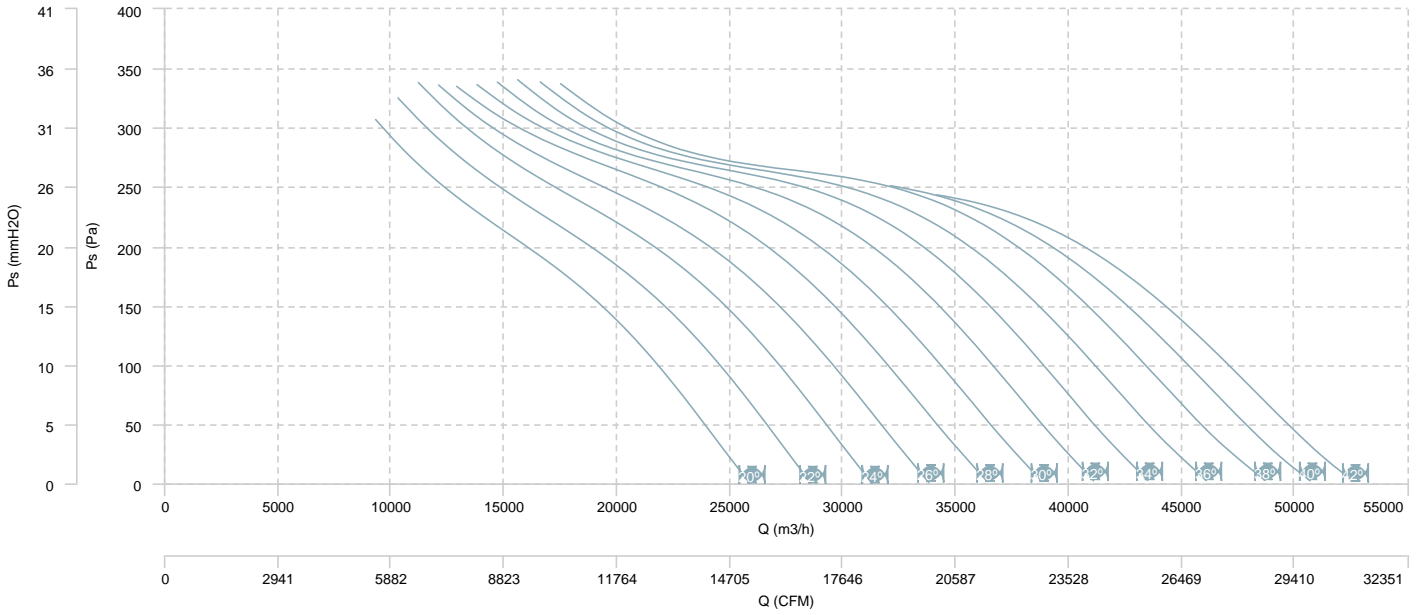

AIR FLOW - MECHANICAL POWER

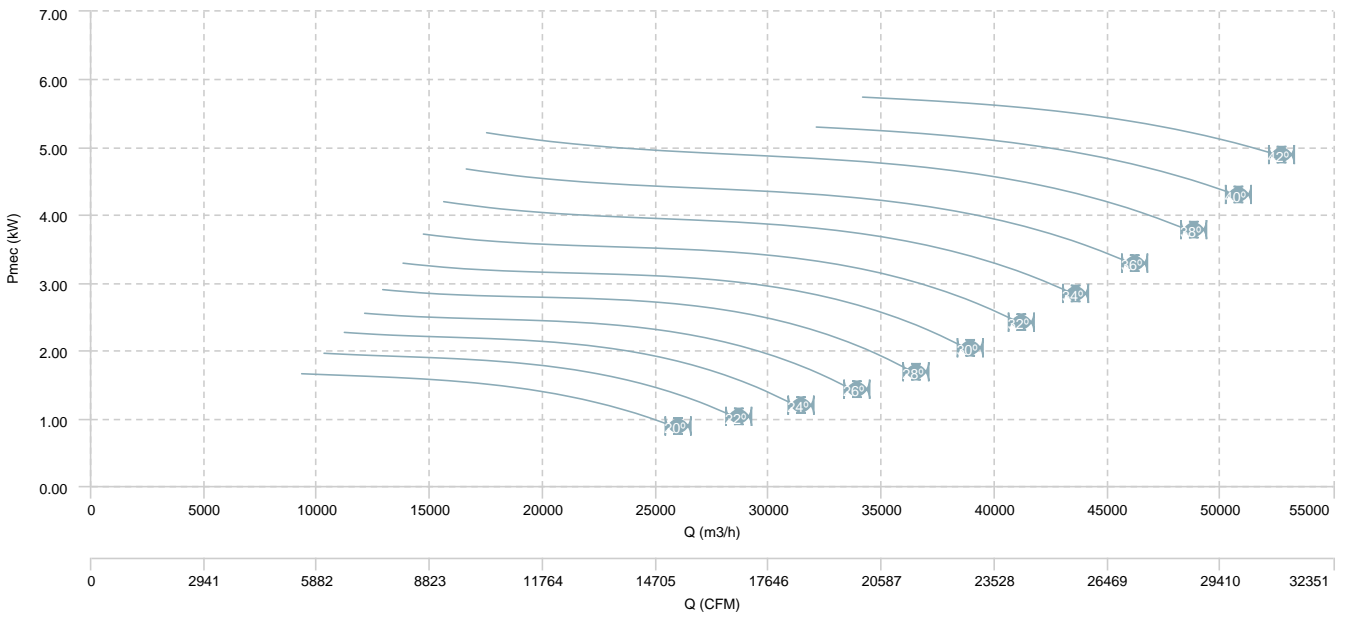

HB 100 T4/T8 (A6:3)

AIR FLOW - PRESSURE (4 poles)

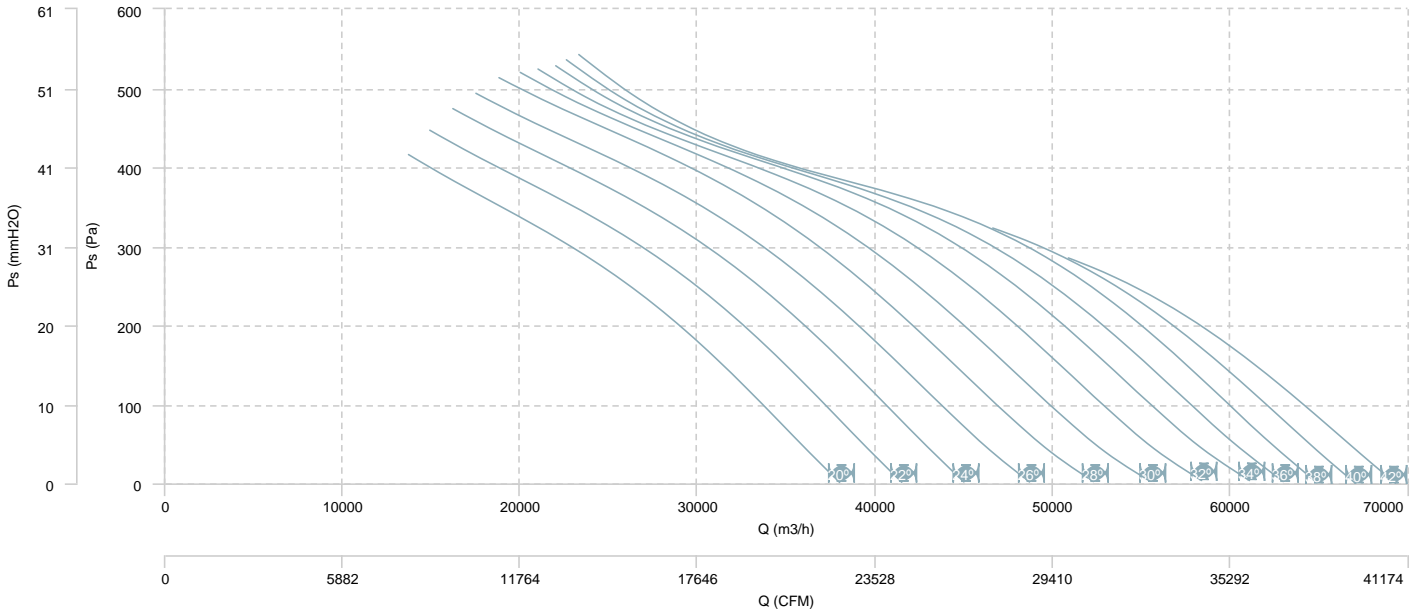

AIR FLOW - MECHANICAL POWER (4 poles)

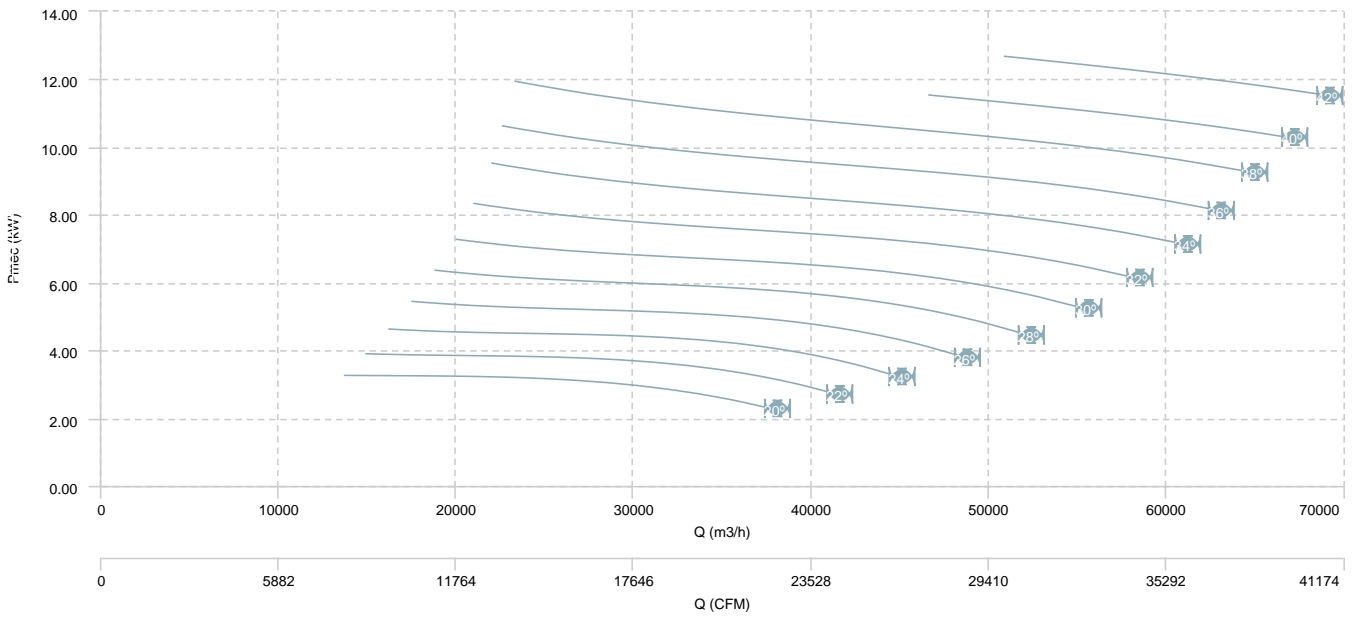

HB 100 T4/T8 (A6:3)

AIR FLOW - PRESSURE (8 poles)

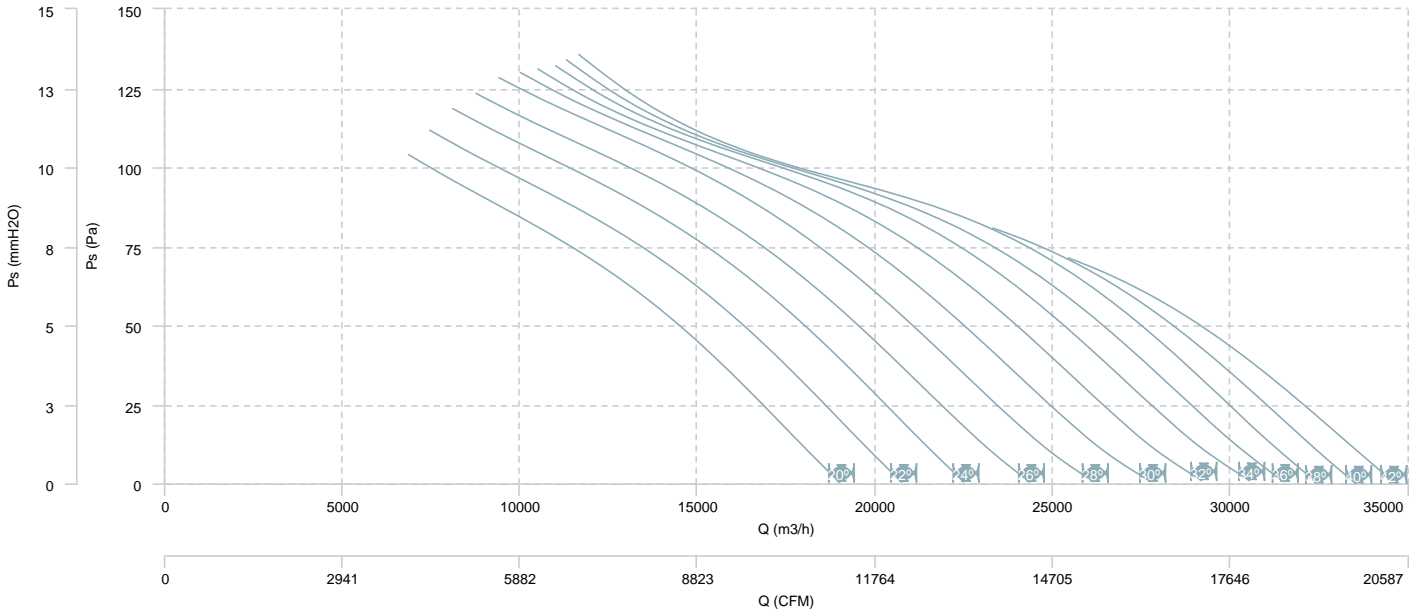

AIR FLOW - MECHANICAL POWER (8 poles)

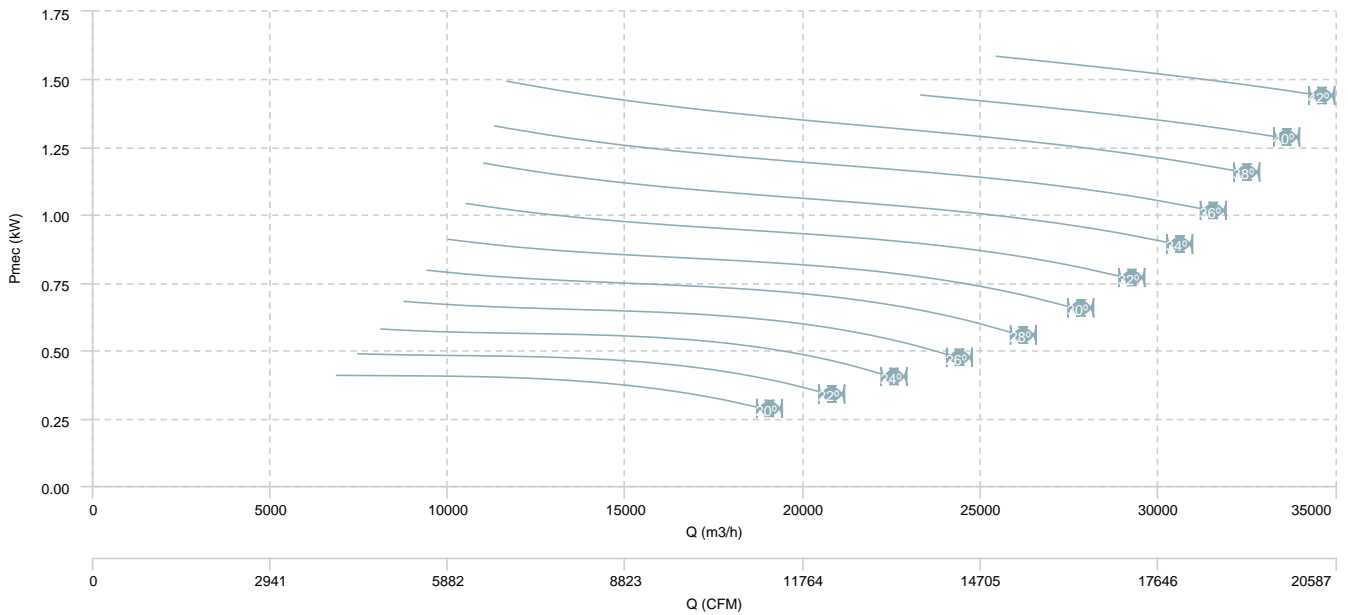

HB 100 T4/T8 (A6:6)

AIR FLOW - PRESSURE (4 poles)

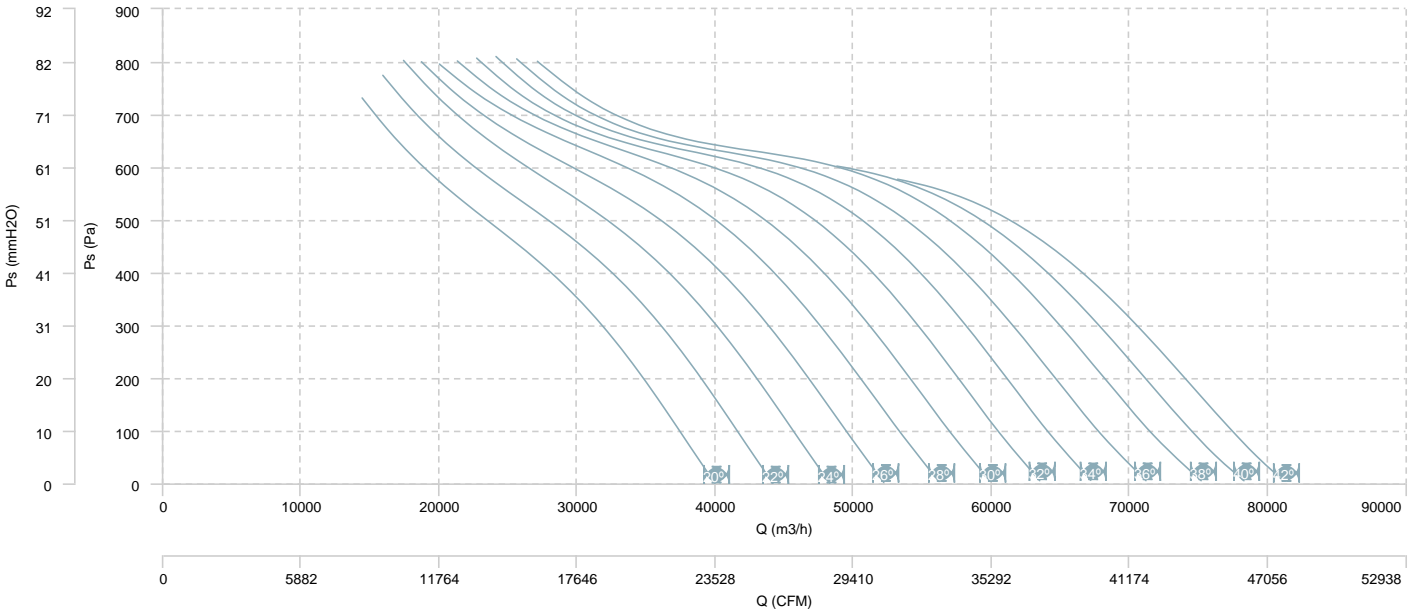

AIR FLOW - MECHANICAL POWER (4 poles)

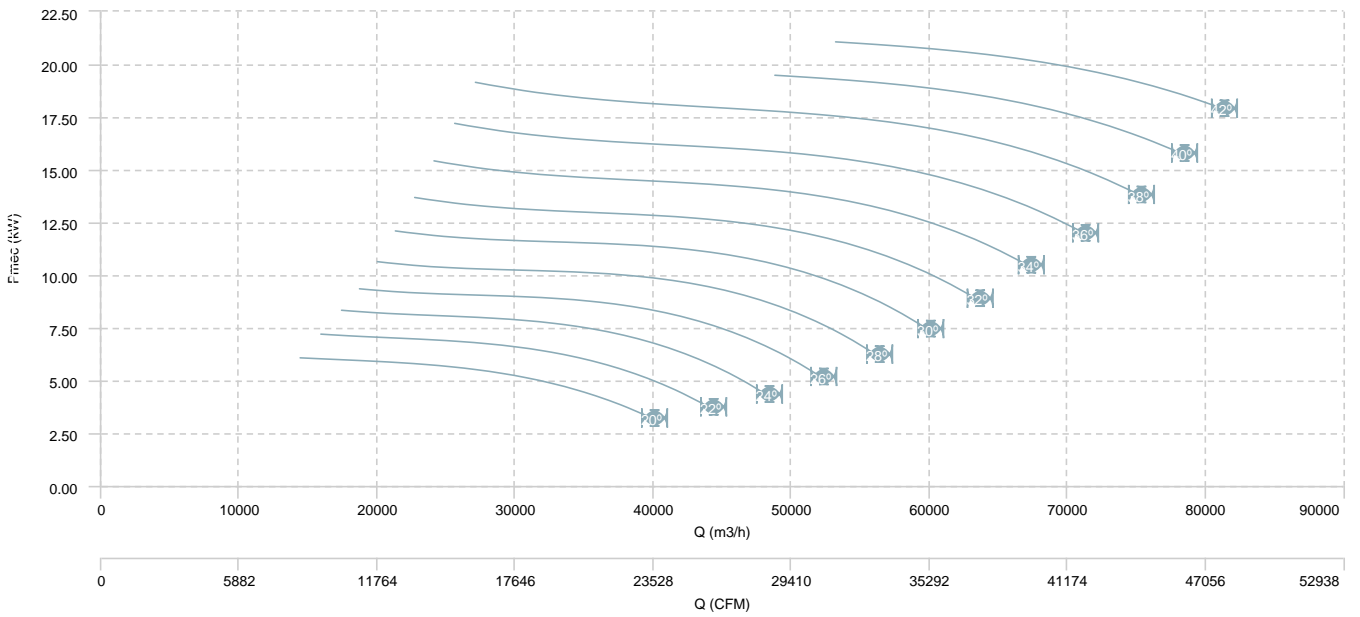

HB 100 T4/T8 (A6:6)

AIR FLOW - PRESSURE (8 poles)

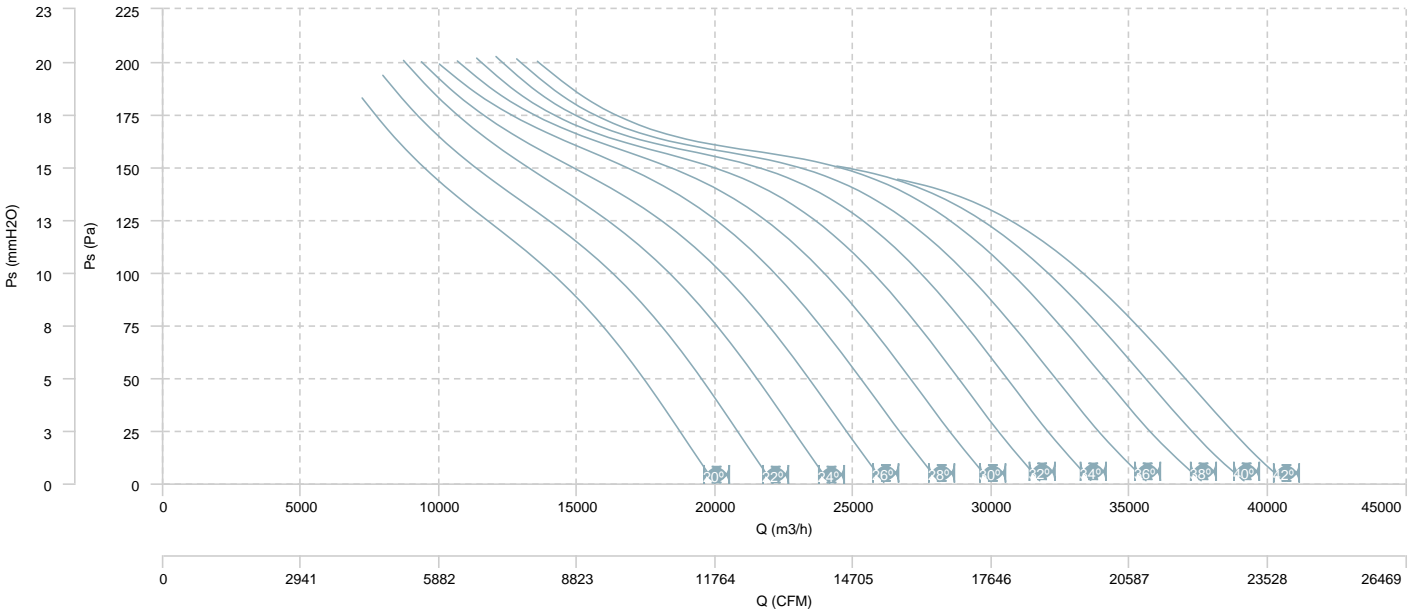

AIR FLOW - MECHANICAL POWER (8 poles)

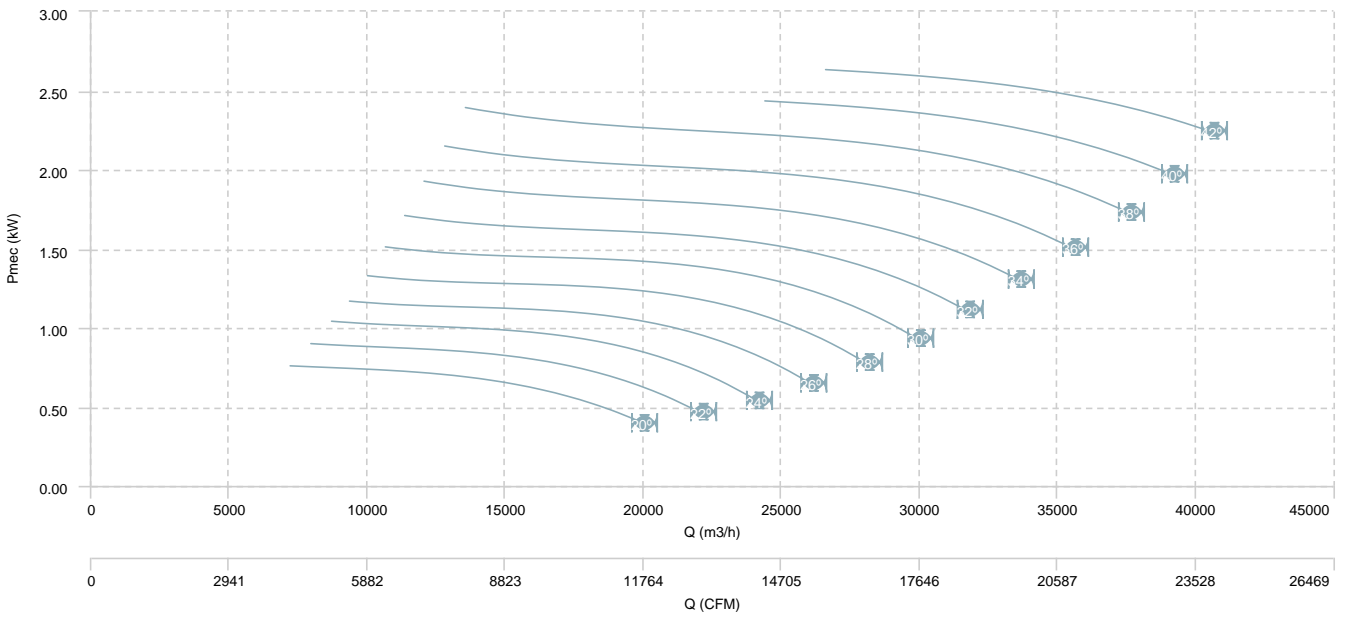

HB 112 T4 (A6:6)

AIR FLOW - PRESSURE

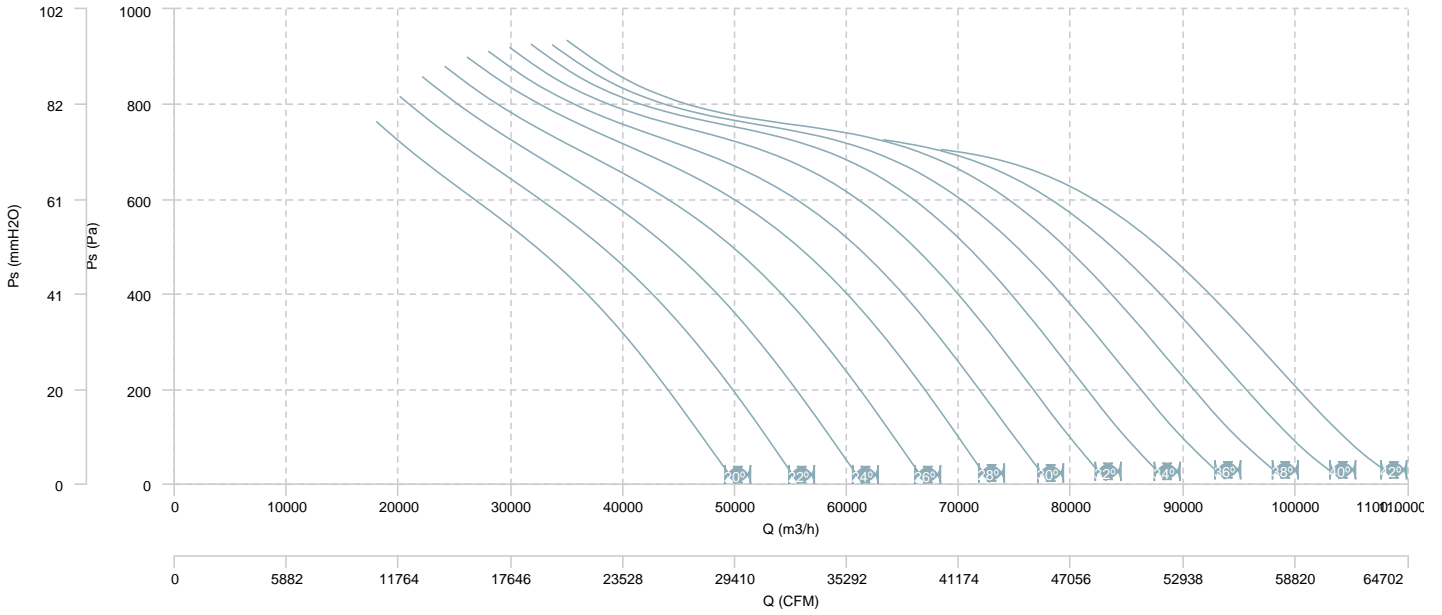

AIR FLOW - MECHANICAL POWER

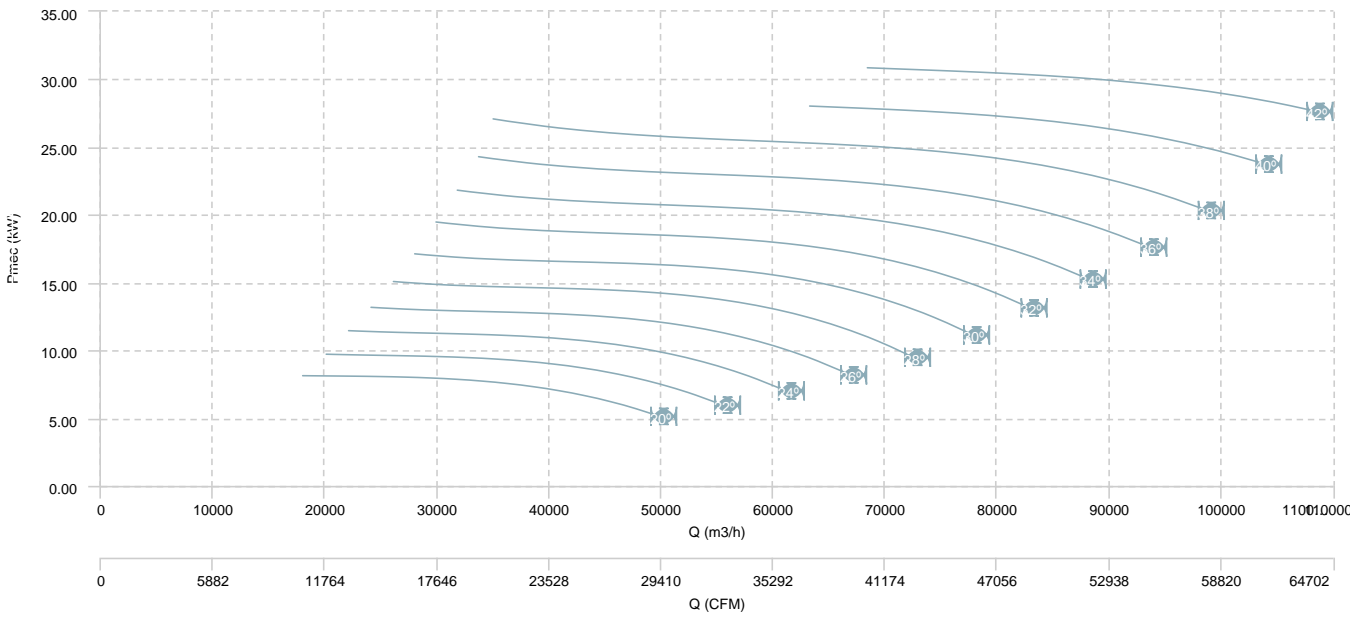

HB 112 T4 (A6:3)

AIR FLOW - PRESSURE

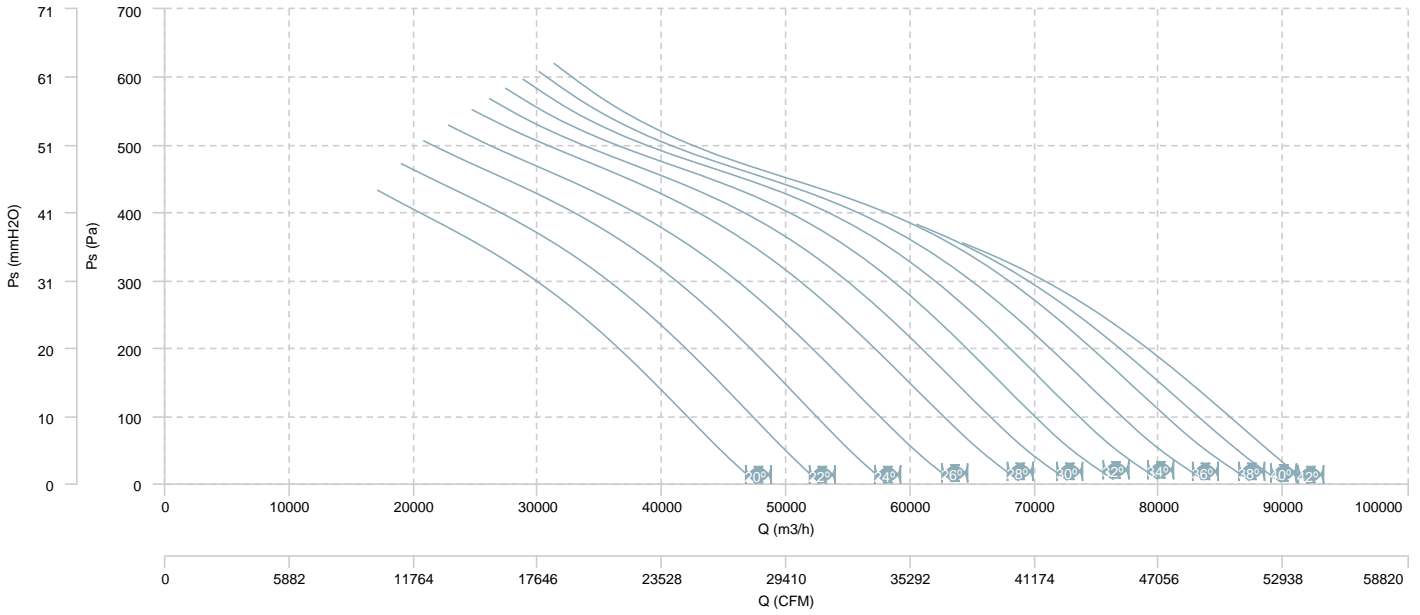

AIR FLOW - MECHANICAL POWER

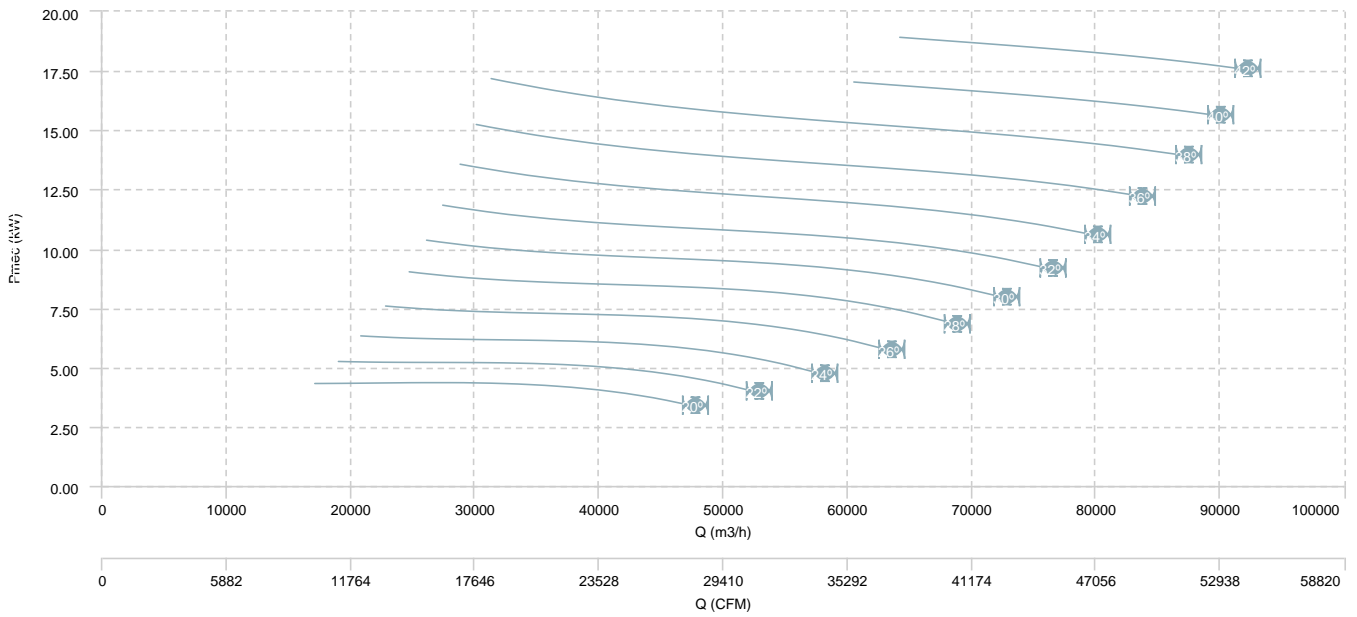

HB 112 T6 (A6:3)

AIR FLOW - PRESSURE

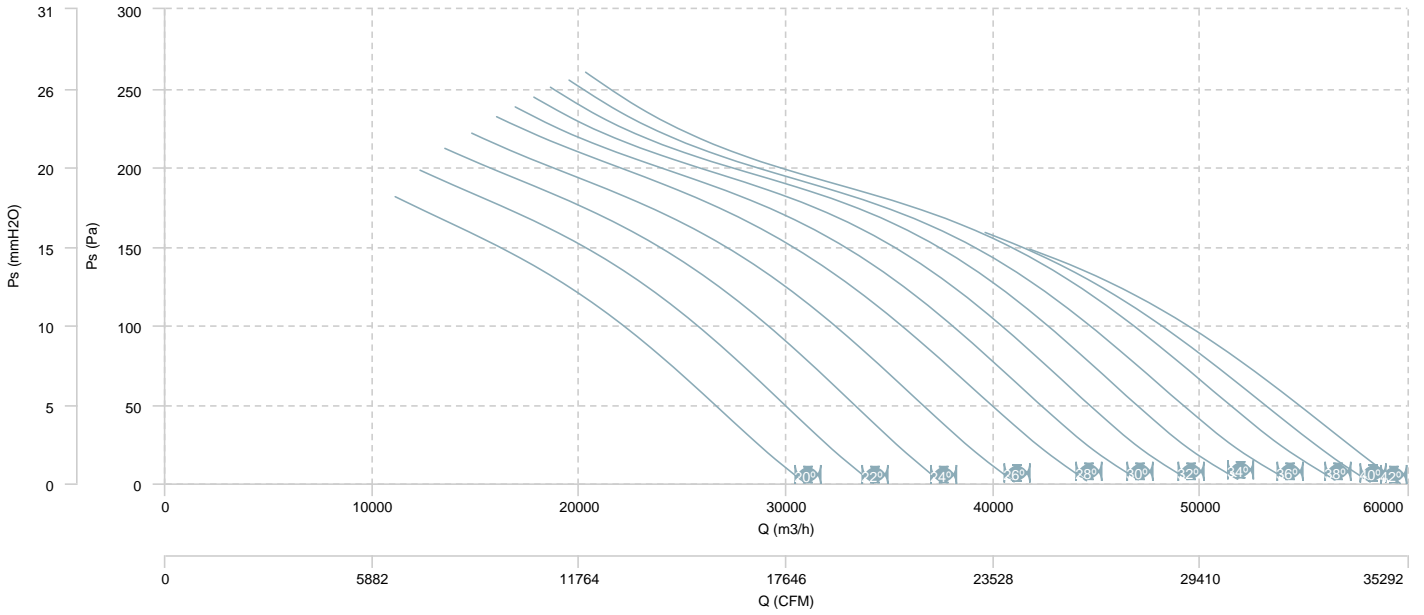

AIR FLOW - MECHANICAL POWER

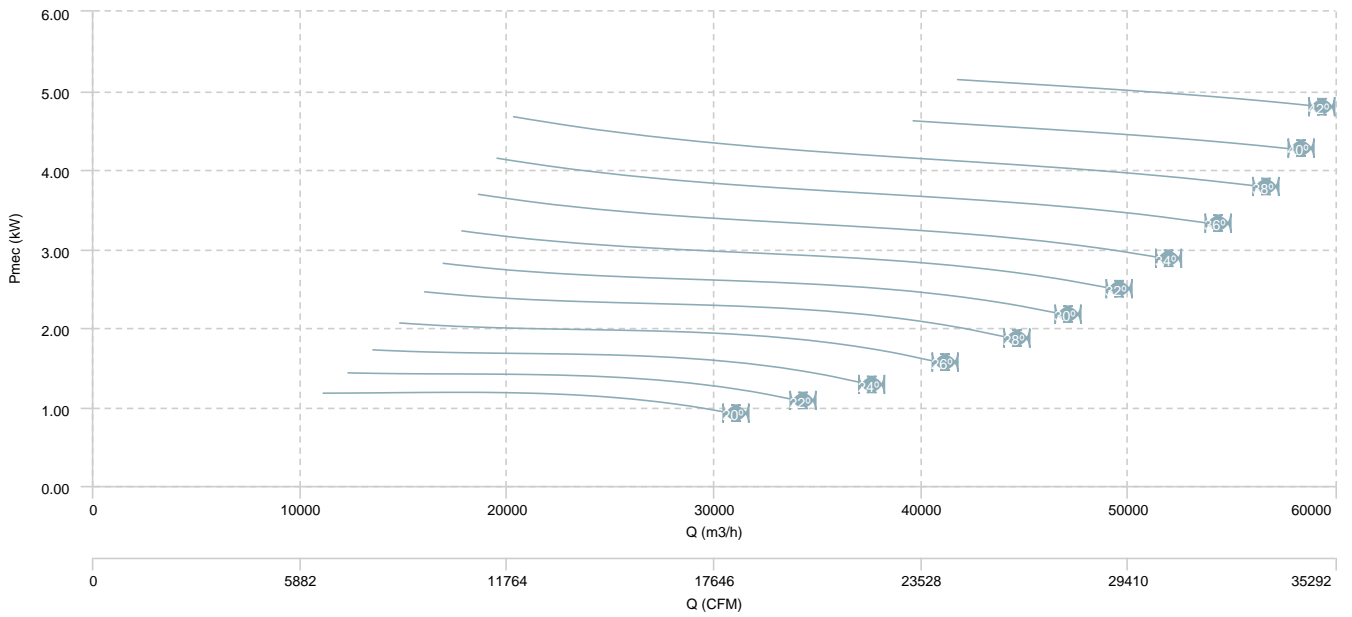

HB 112 T6 (A6:6)

AIR FLOW - PRESSURE

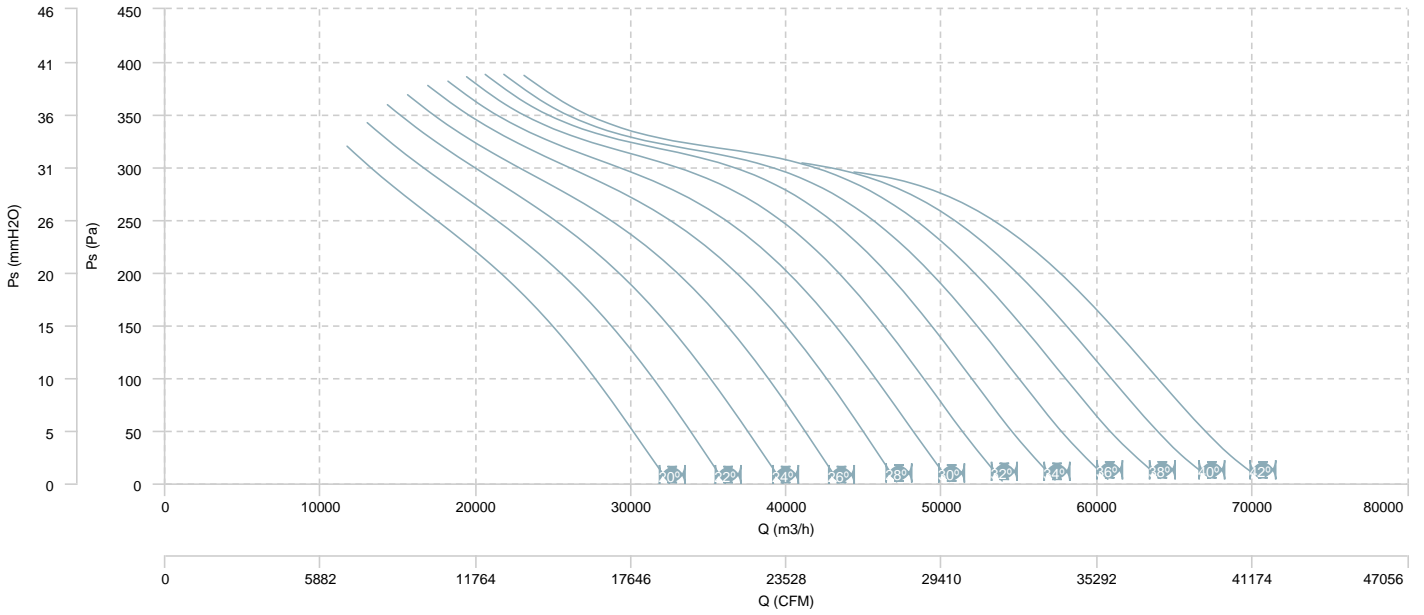

AIR FLOW - MECHANICAL POWER

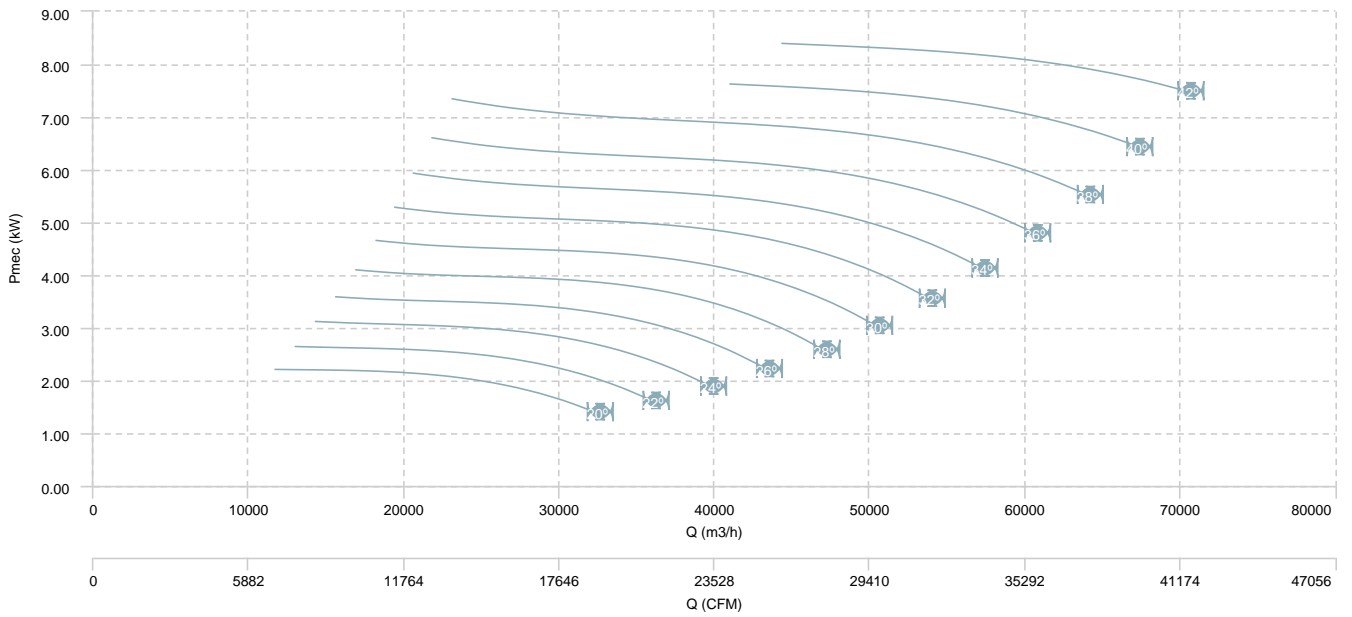

HB 112 T4/T8 (A6:3)

AIR FLOW - PRESSURE (4 poles)

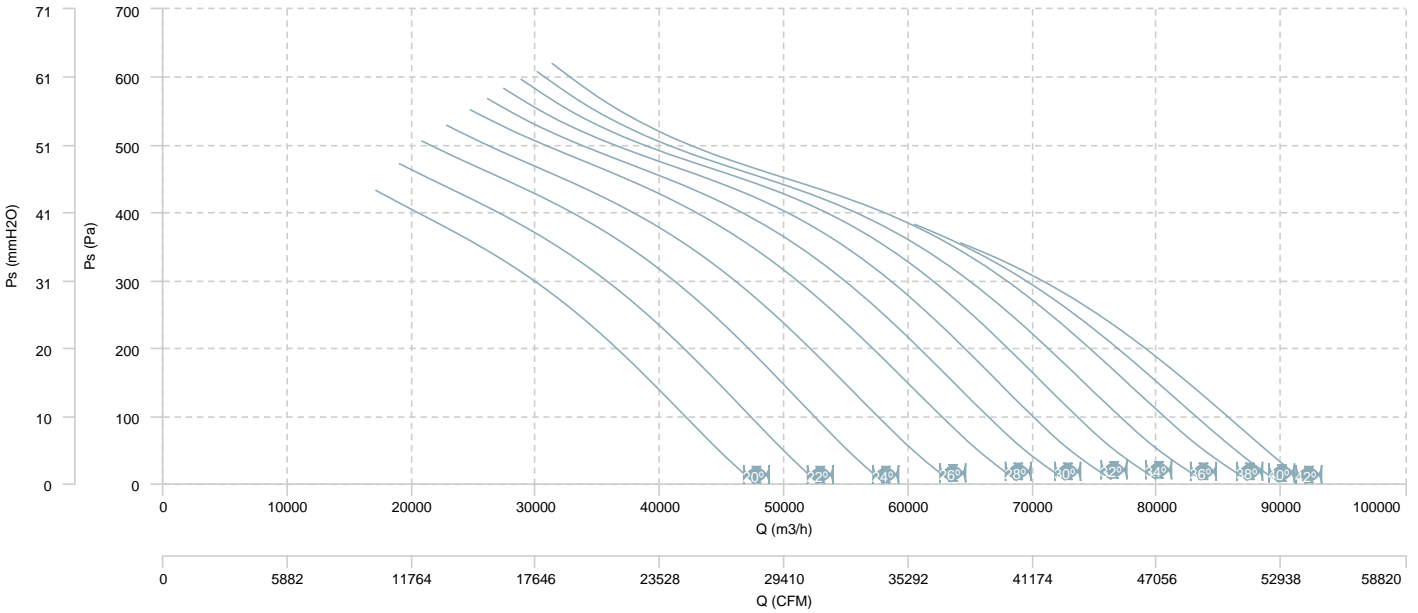

AIR FLOW - MECHANICAL POWER (4 poles)

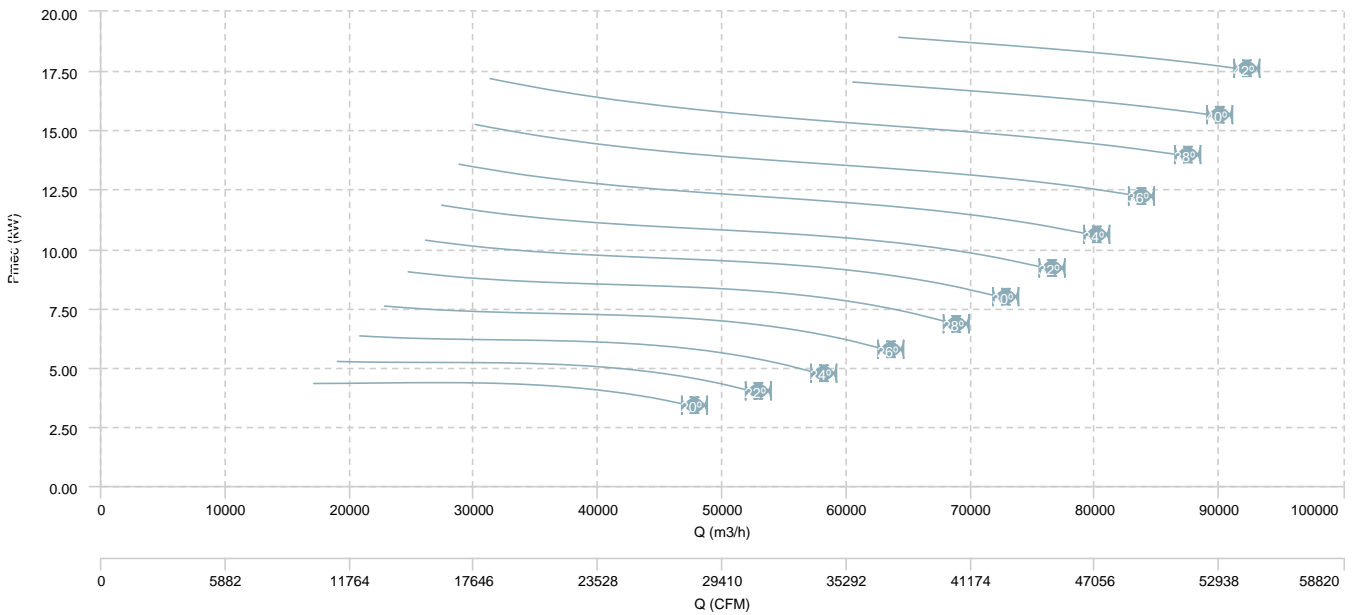

HB 112 T4/T8 (A6:3)

AIR FLOW - PRESSURE (8 poles)

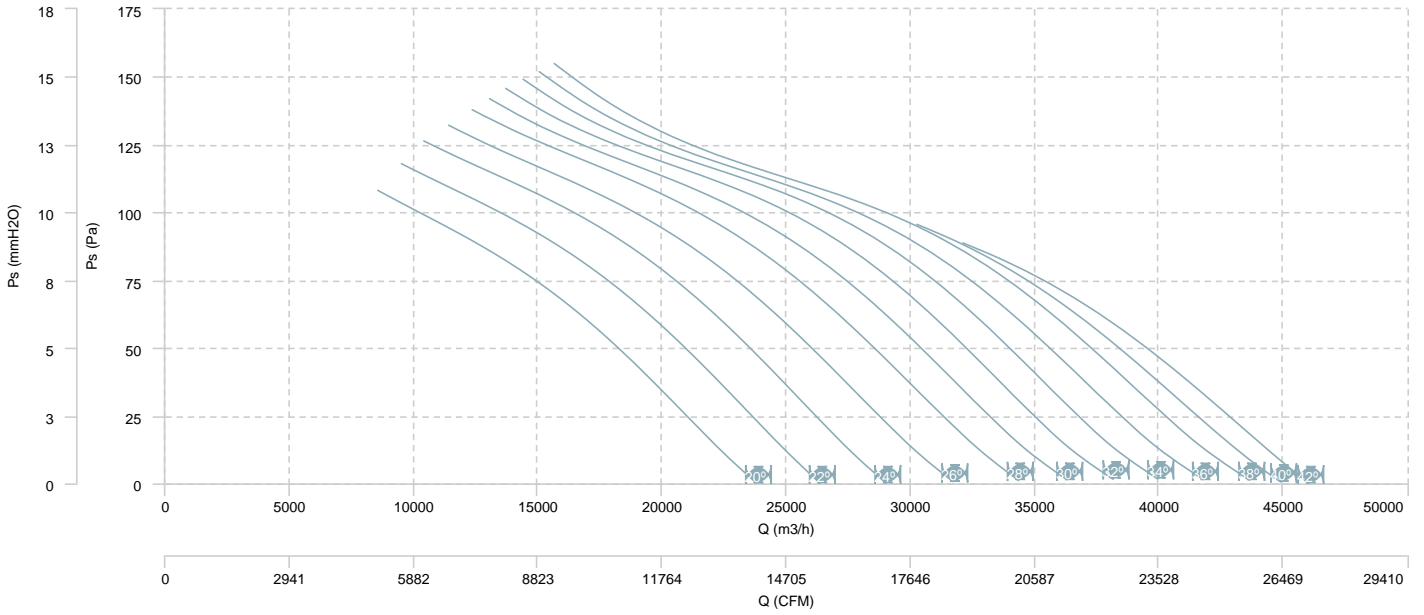

AIR FLOW - MECHANICAL POWER (8 poles)

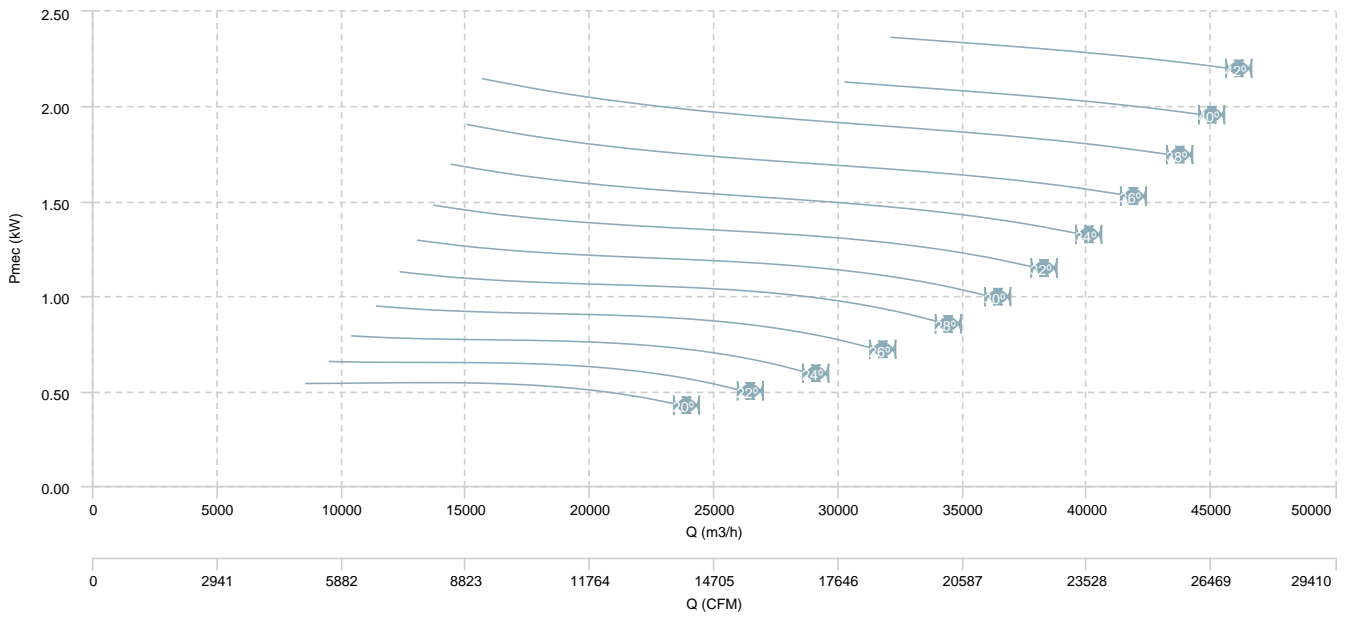

HB 112 T4/T8 (A6:6)

AIR FLOW - PRESSURE (4 poles)

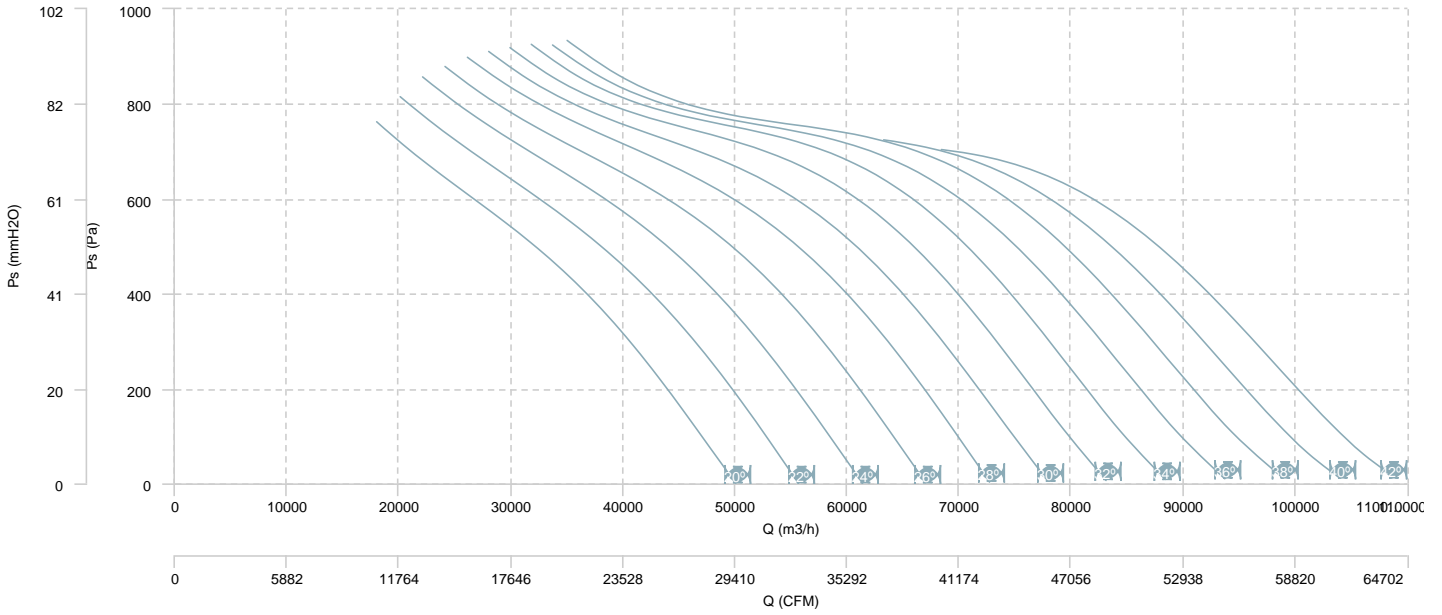

AIR FLOW - MECHANICAL POWER (4 poles)

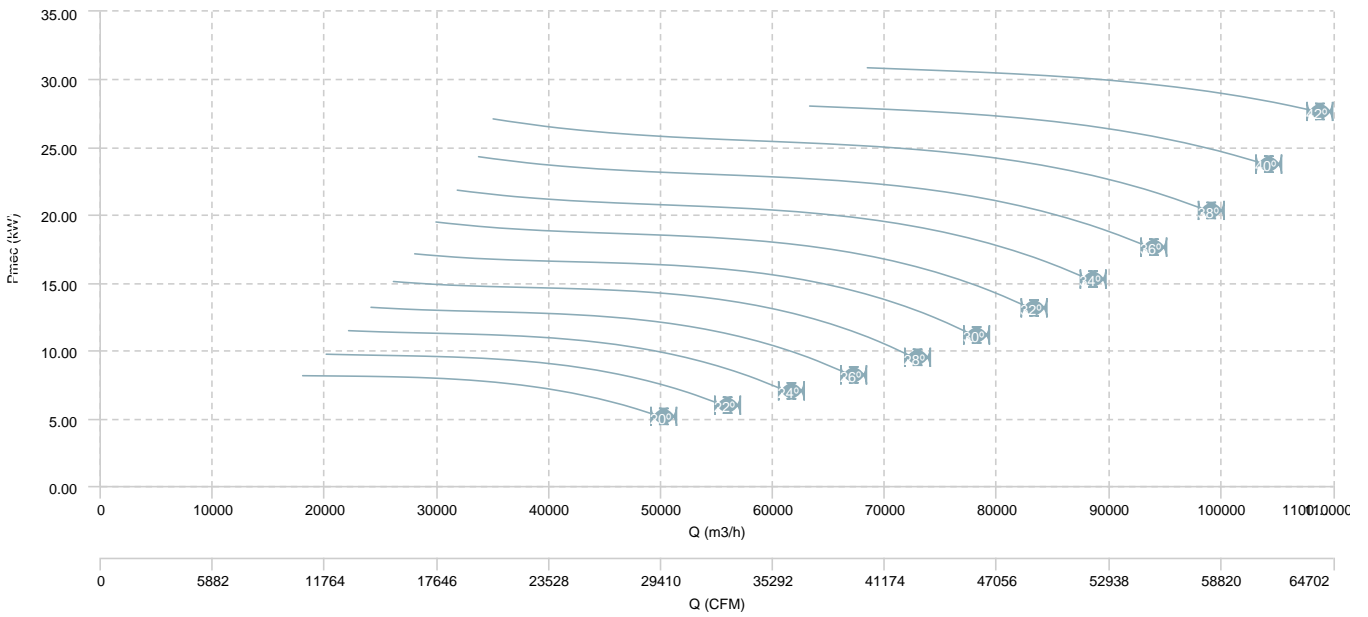

HB 112 T4/T8 (A6:6)

AIR FLOW - PRESSURE (8 poles)

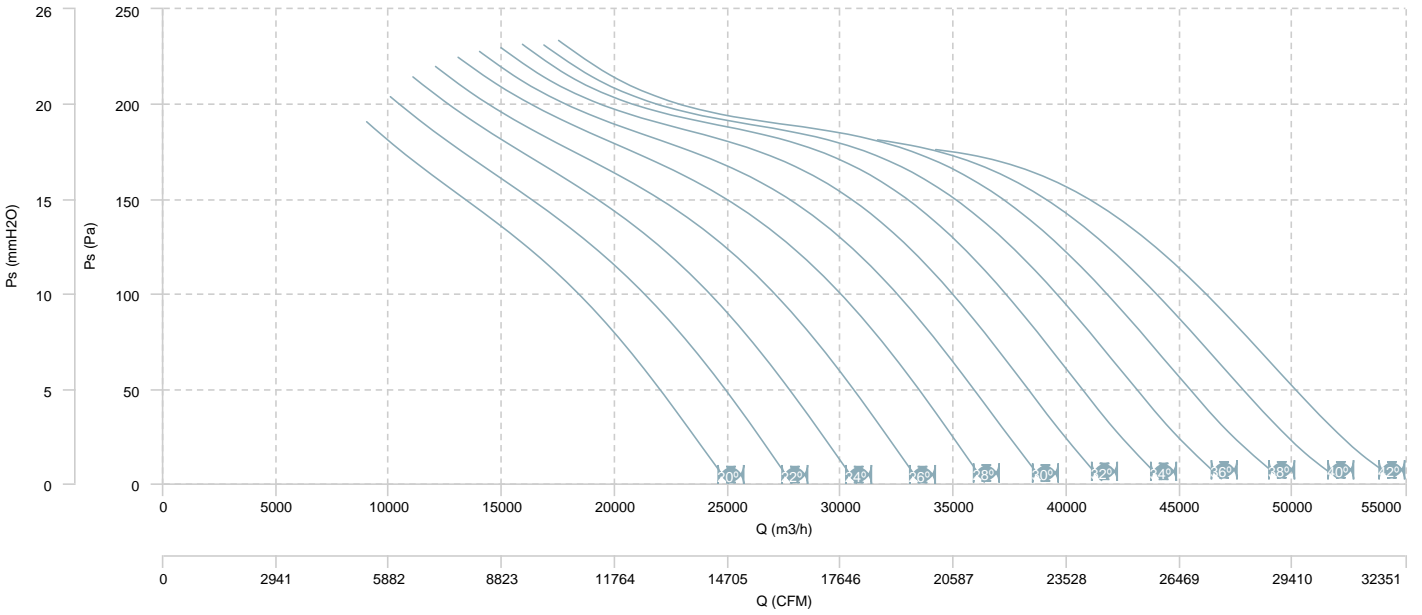

AIR FLOW - MECHANICAL POWER (8 poles)

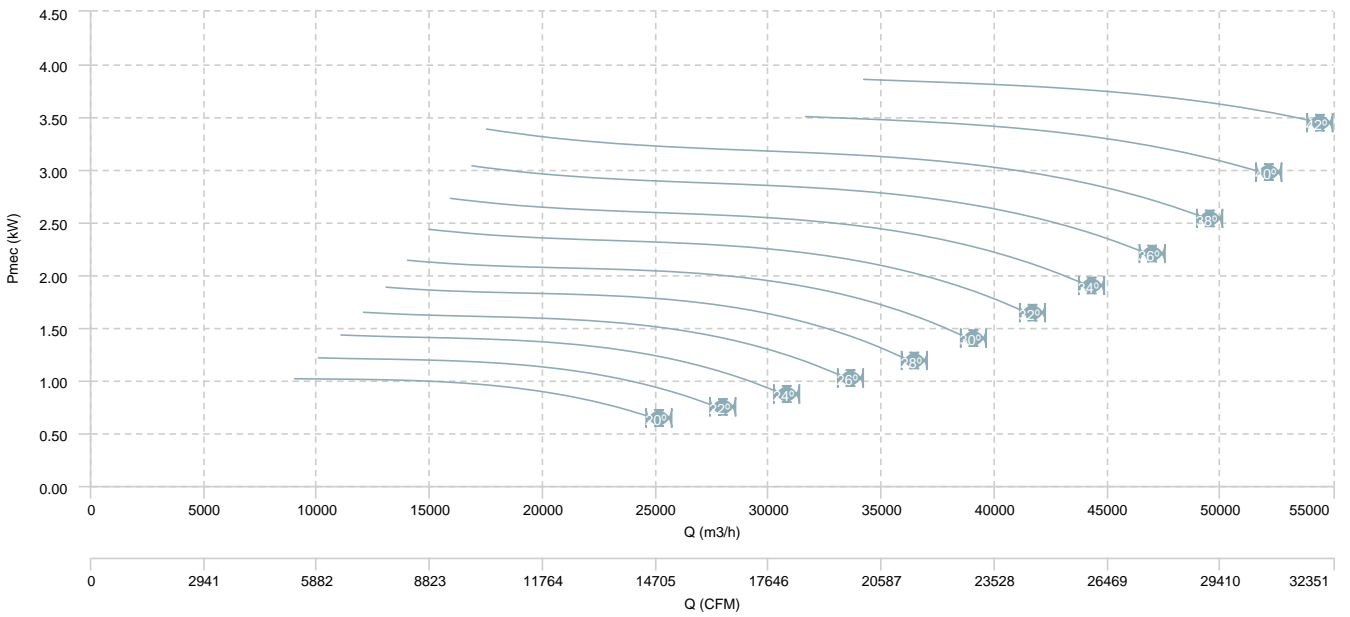

HB 125 T4 (A7:4)

AIR FLOW - PRESSURE

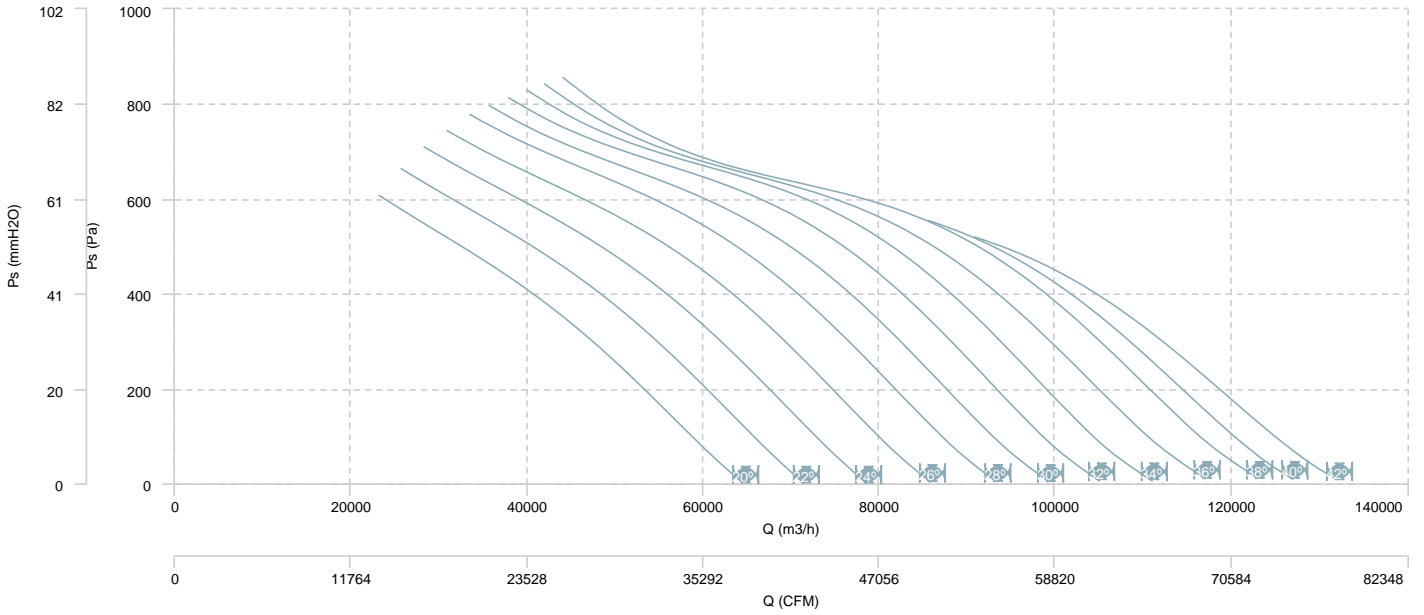

AIR FLOW - MECHANICAL POWER

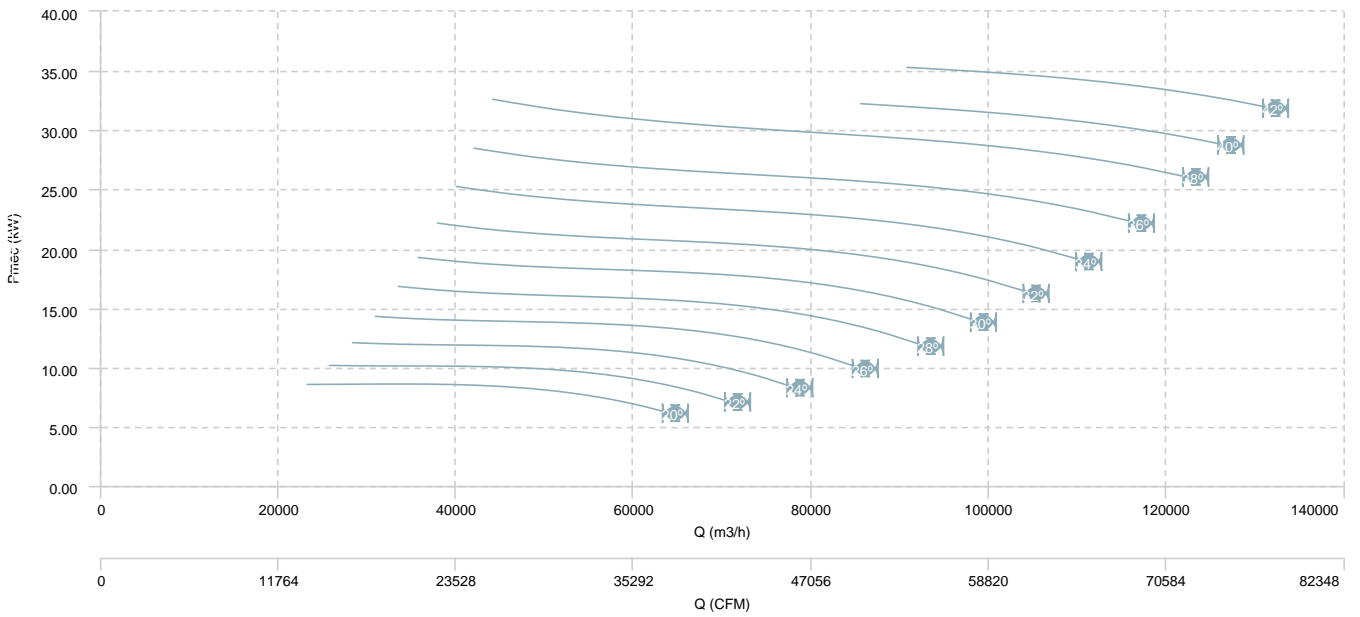

HB 125 T4 (A7:8)

AIR FLOW - PRESSURE

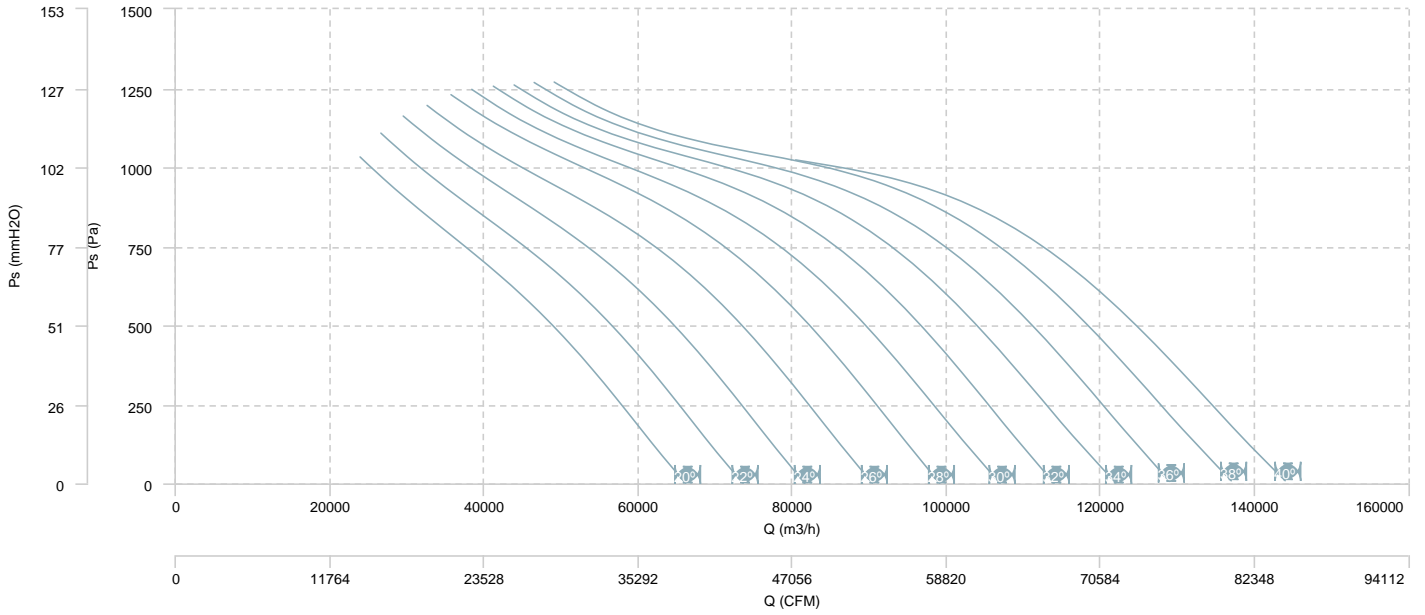

AIR FLOW - MECHANICAL POWER

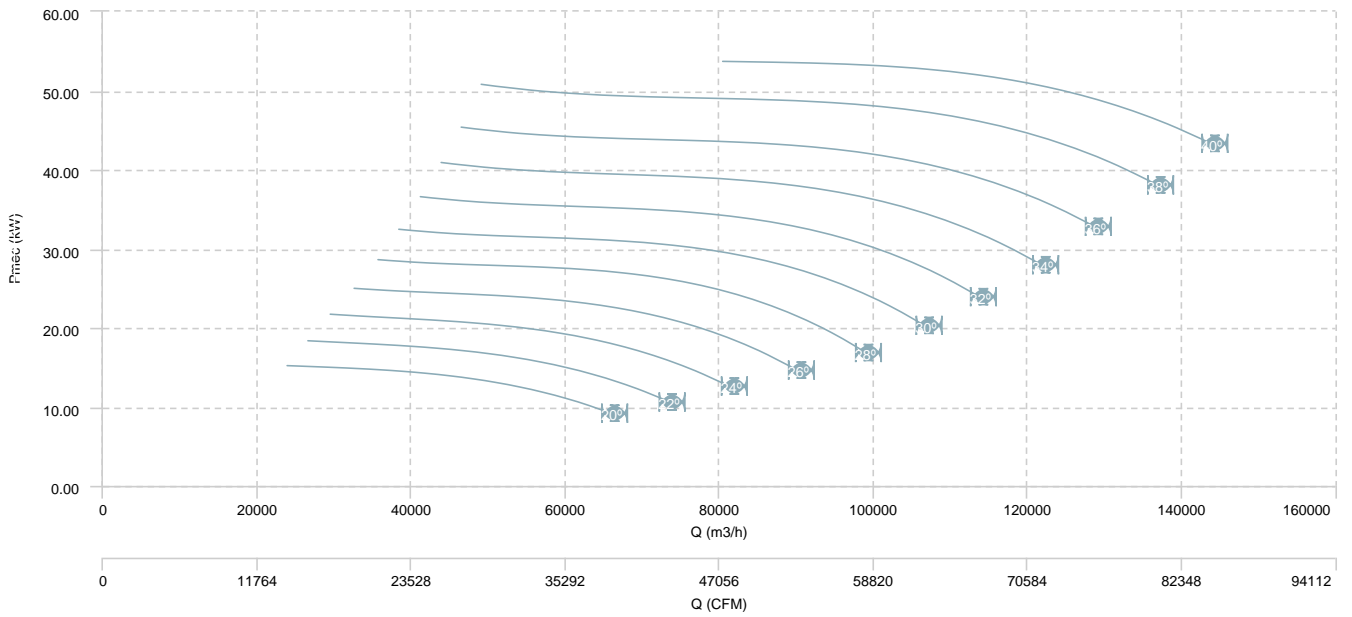

HB 125 T6 (A7:4)

AIR FLOW - PRESSURE

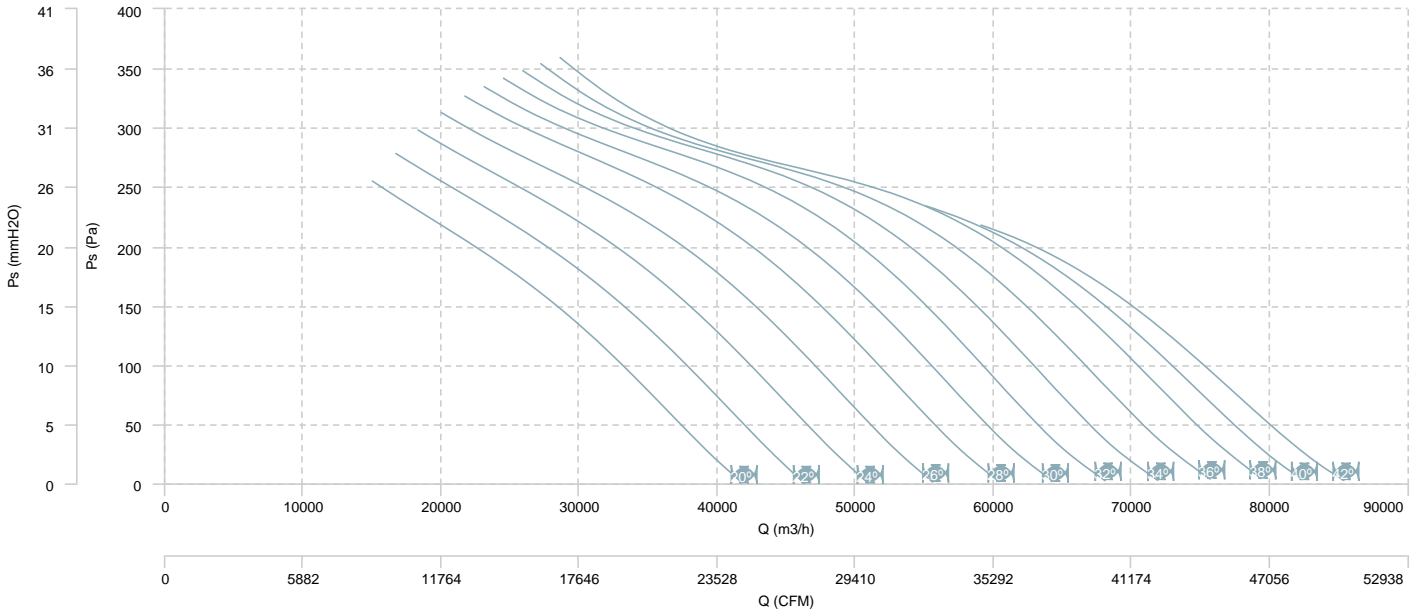

AIR FLOW - MECHANICAL POWER

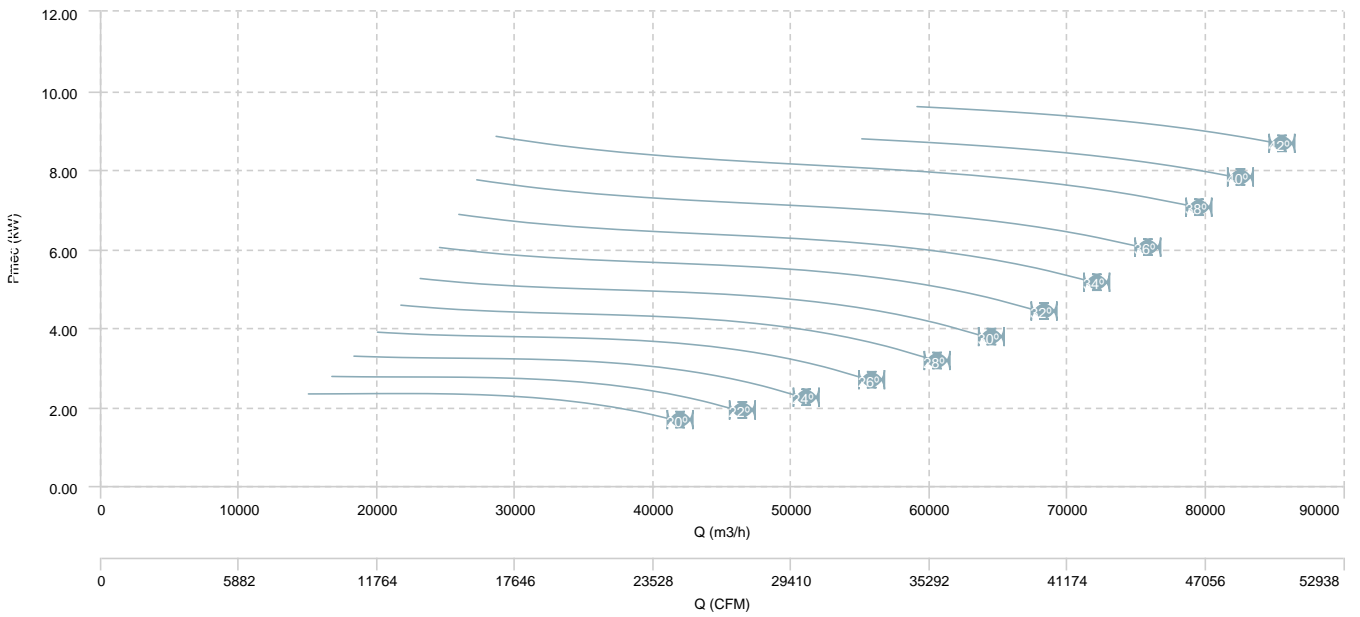

HB 125 T6 (A7:8)

AIR FLOW - PRESSURE

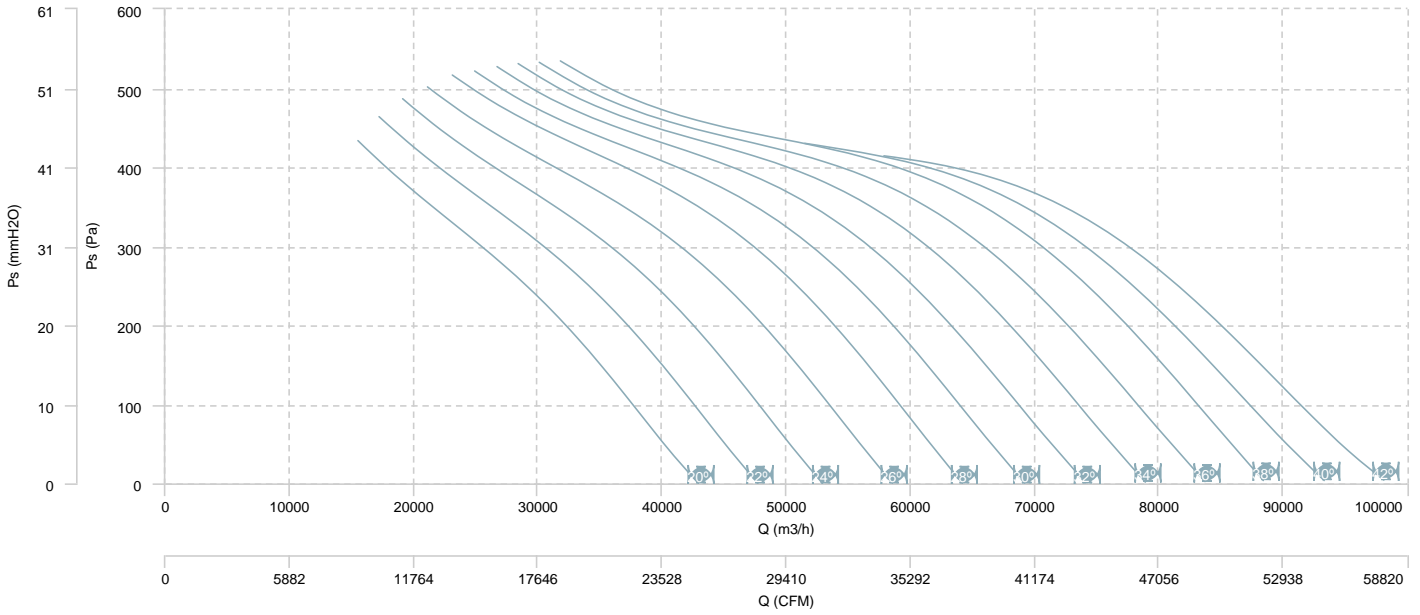

AIR FLOW - MECHANICAL POWER

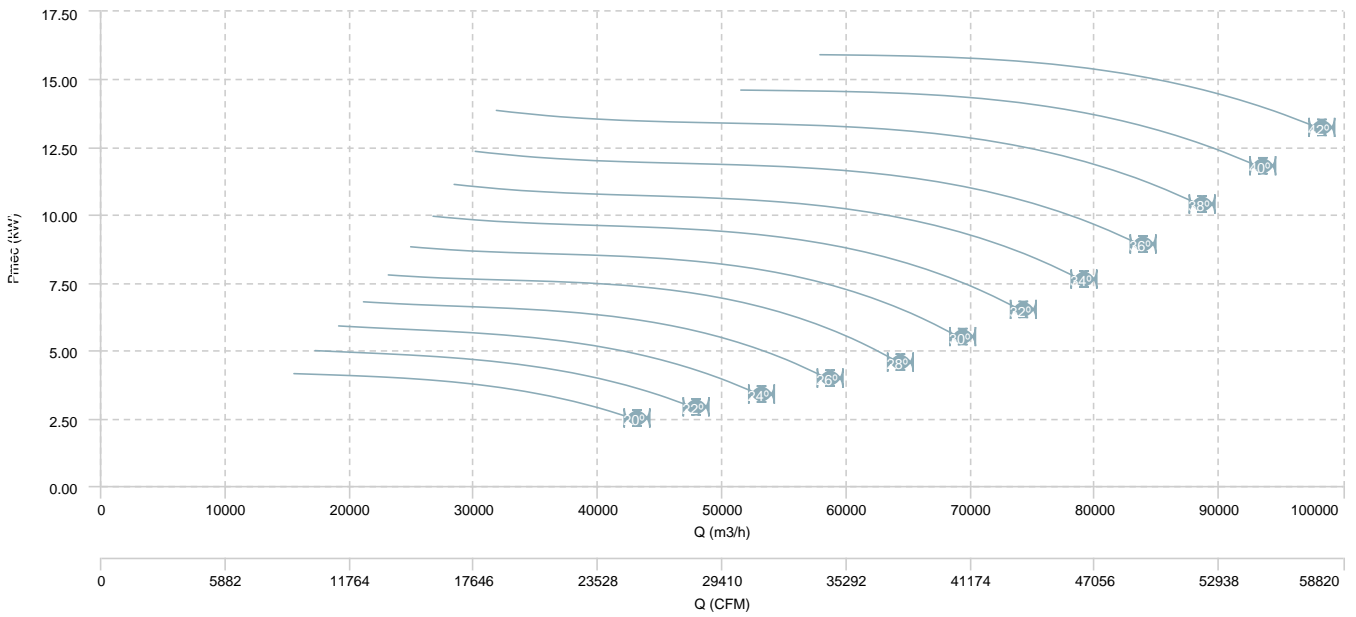

HB 125 T4/T8 (A7:4)

AIR FLOW - PRESSURE (4 poles)

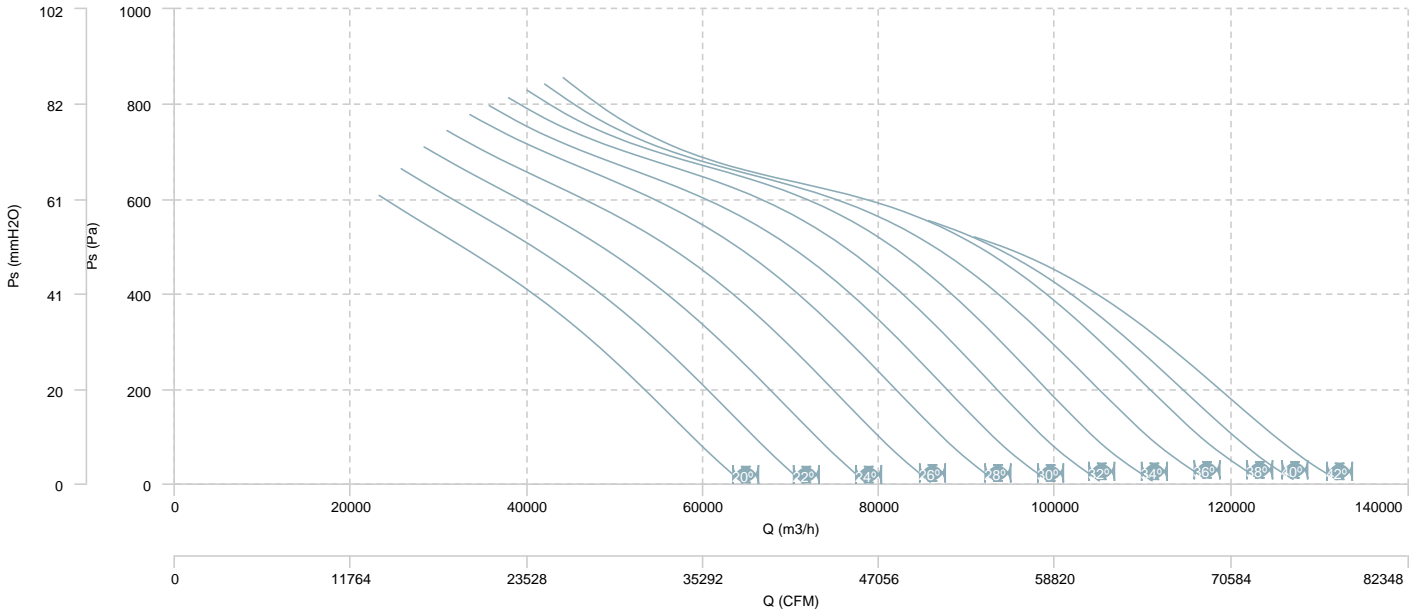

AIR FLOW - MECHANICAL POWER (4 poles)

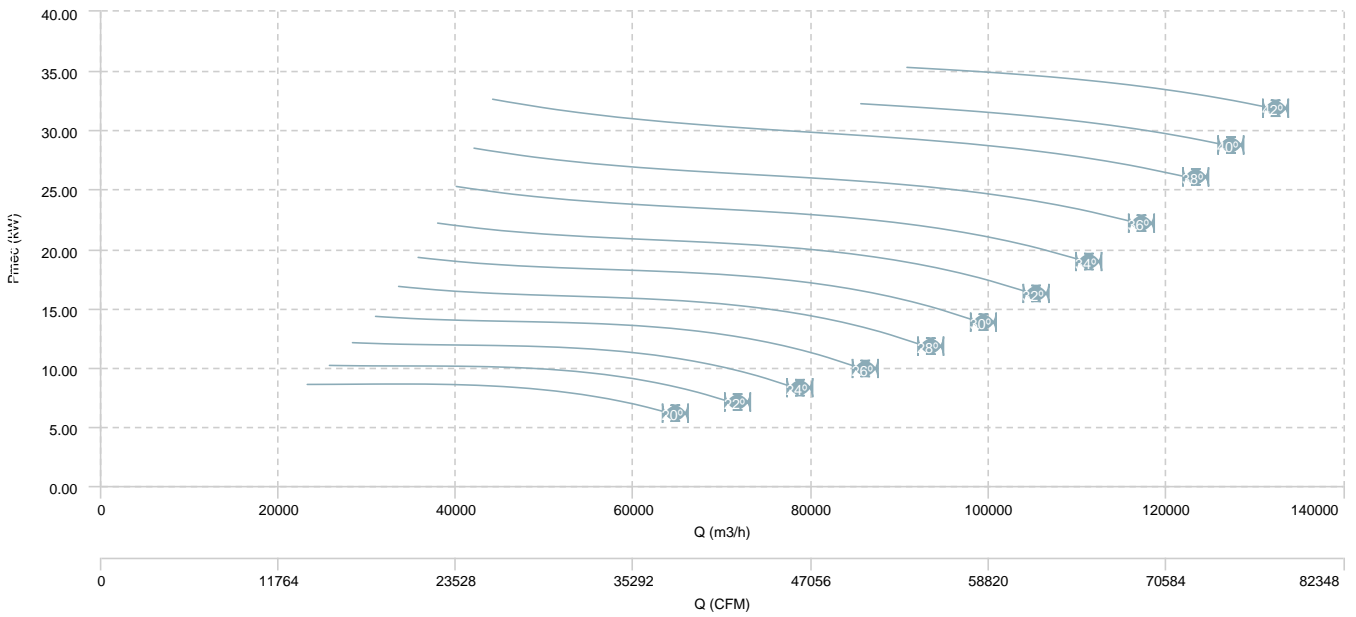

HB 125 T4/T8 (A7:4)

AIR FLOW - PRESSURE (8 poles)

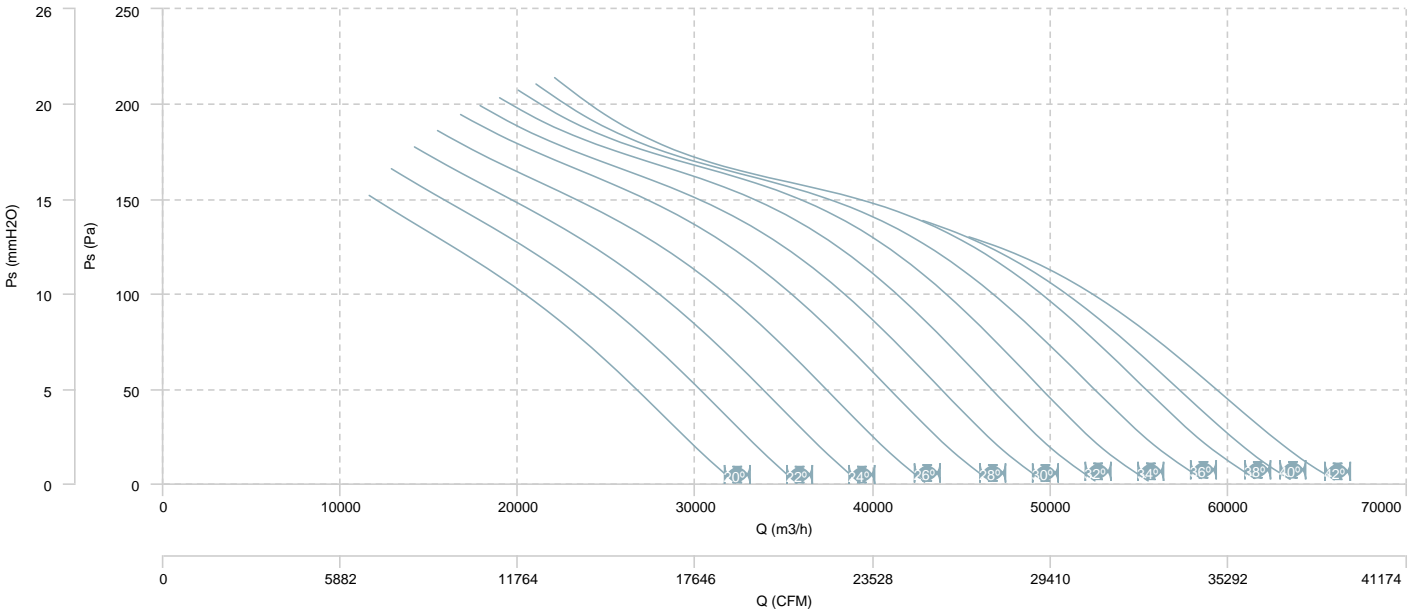

AIR FLOW - MECHANICAL POWER (8 poles)

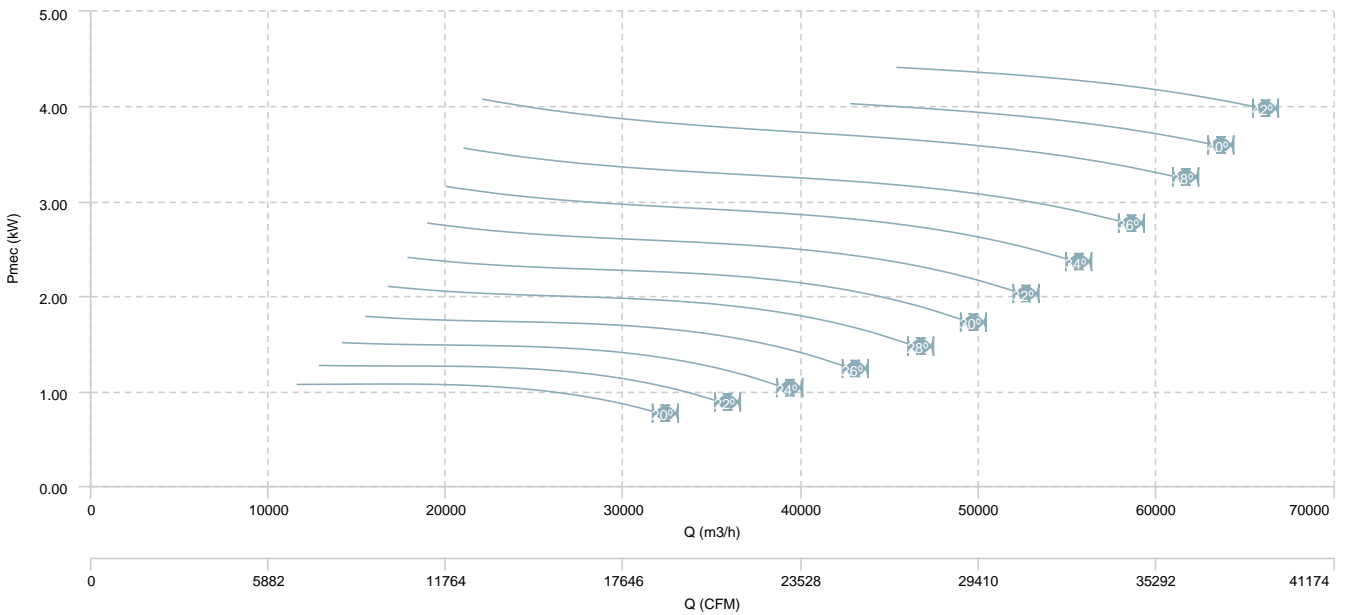

HB 125 T4/T8 (A7:8)

AIR FLOW - PRESSURE (4 poles)

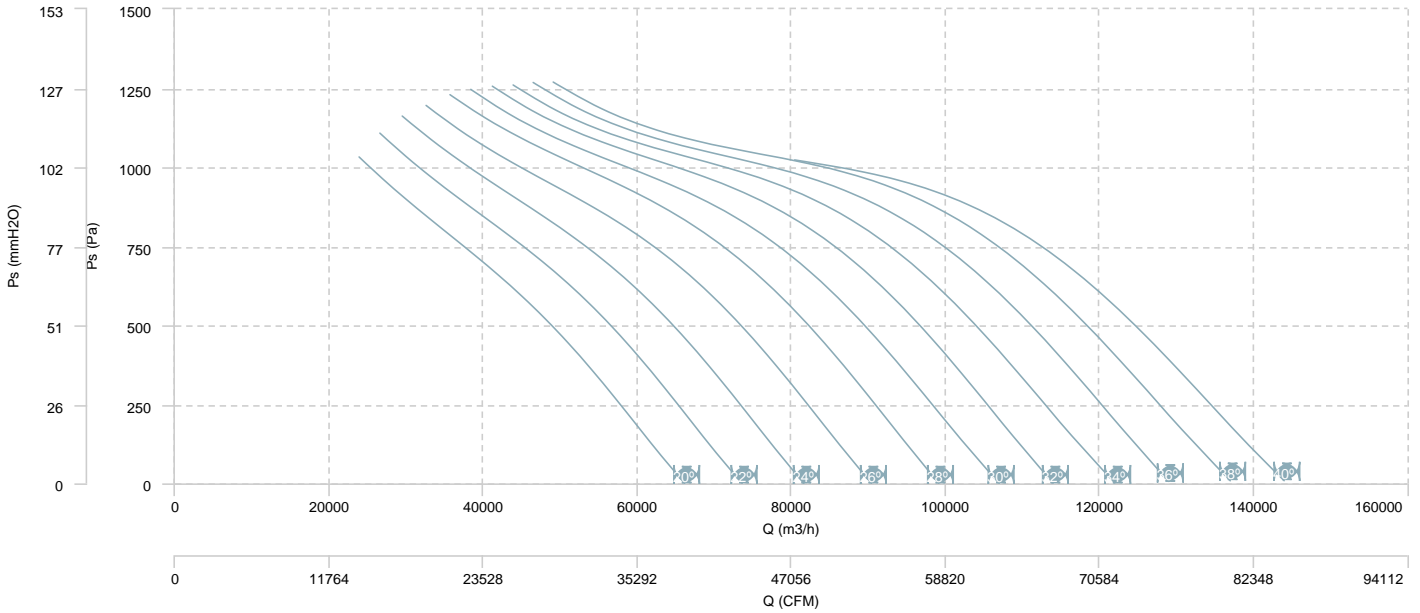

AIR FLOW - MECHANICAL POWER (4 poles)

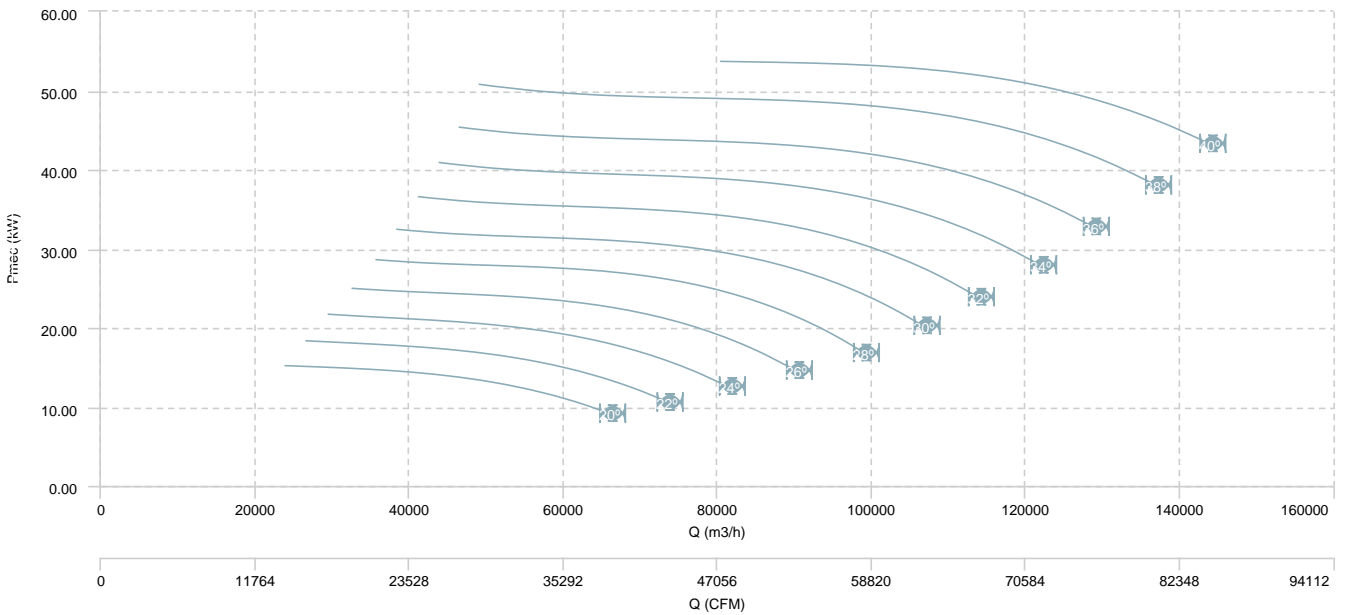

HB 125 T4/T8 (A7:8)

AIR FLOW - PRESSURE (8 poles)

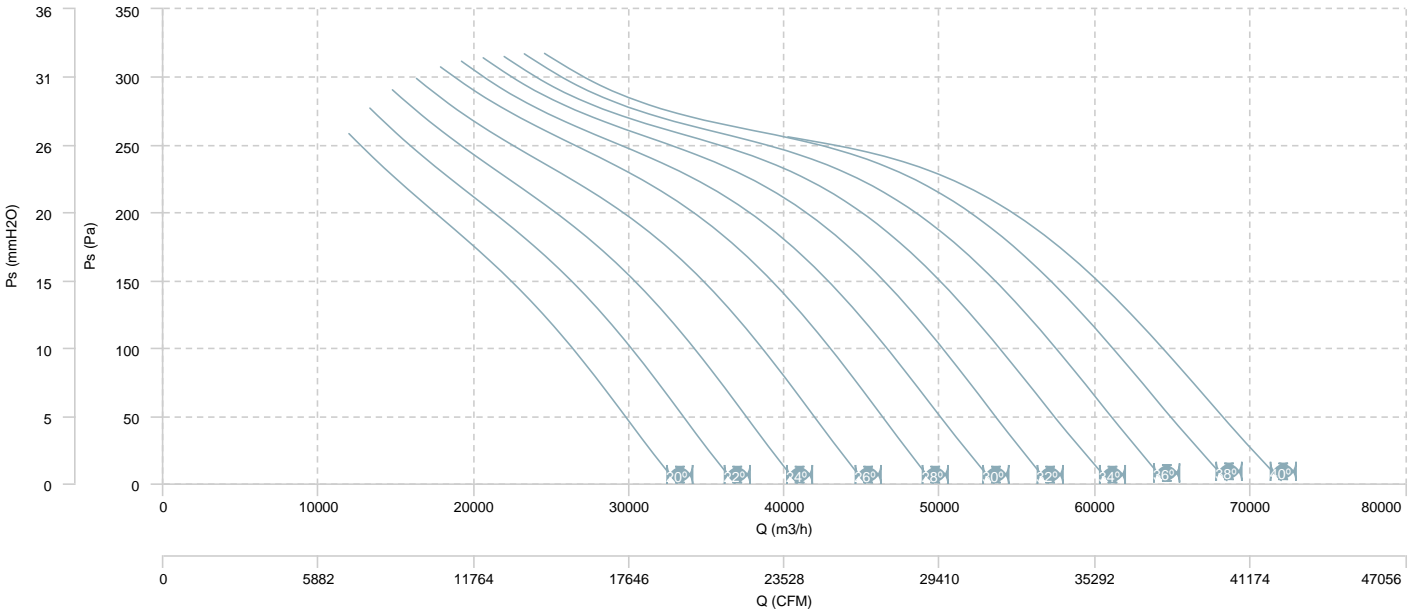

AIR FLOW - MECHANICAL POWER (8 poles)

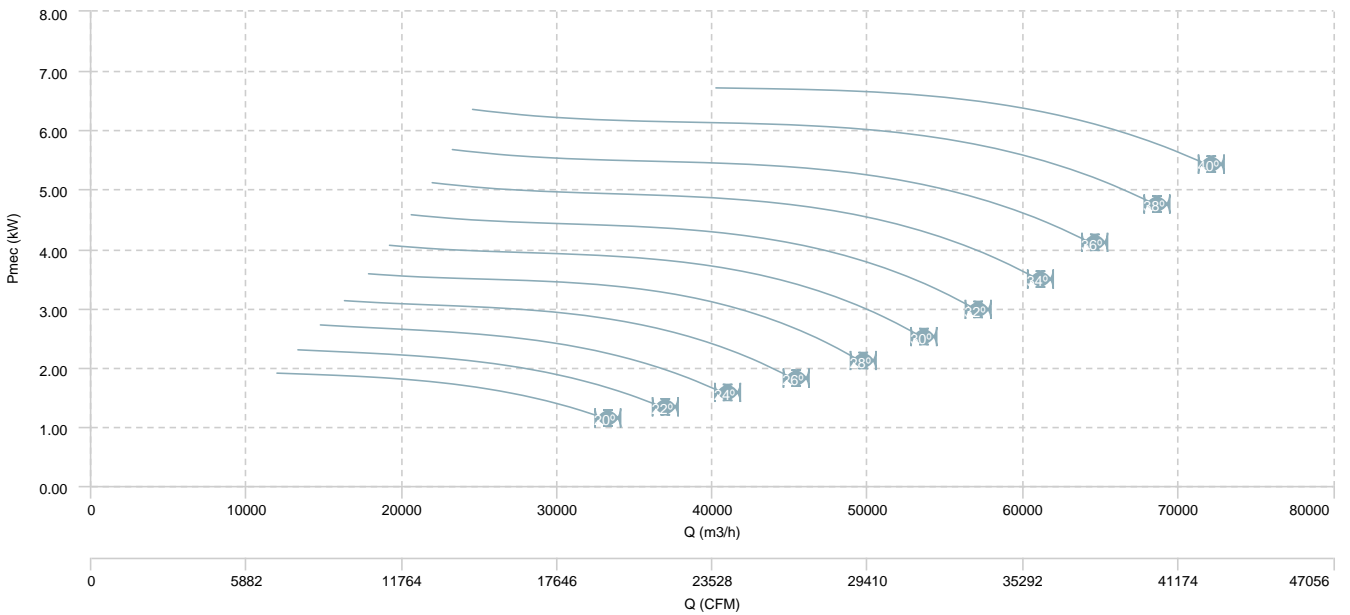

Sound data

Sound / 2 poles

Sound power Lw dB (A)										
Model		63 Hz	125 Hz	250 Hz	500 Hz	1000 Hz	2000 Hz	4000 Hz	8000 Hz	Total
HB 35 M2 (A0:6) (25 ^º)	Inlet	55	65	70	79	80	79	80	75	86
HB 35 M2 (A0:6) (30 ^º)	Inlet	55	63	69	76	77	77	78	73	84
HB 35 M2 (A0:6) (35 ^º)	Inlet	54	62	68	72	75	75	77	71	82
HB 35 M2 (A0:6) (40 ^º)	Inlet	56	64	69	74	76	77	78	72	83

Sound / 4 poles

Sound power Lw dB (A)										
Model		63 Hz	125 Hz	250 Hz	500 Hz	1000 Hz	2000 Hz	4000 Hz	8000 Hz	Total
HB 35 M4 (A0:6) (35 ^º)	Inlet	65	63	62	60	60	59	61	57	71
HB 35 M4 (A0:6) (40 ^º)	Inlet	67	65	64	62	61	61	62	58	72
HB 35 T4 (A0:6) (35 ^º)	Inlet	65	63	62	60	60	59	61	57	71
HB 35 T4 (A0:6) (40 ^º)	Inlet	67	65	64	62	61	61	62	58	72
HB 40 M4 (A0:6) (35 ^º)	Inlet	69	66	64	62	63	63	64	59	74
HB 40 M4 (A0:6) (40 ^º)	Inlet	73	69	68	66	66	66	66	62	77
HB 40 T4 (A0:6) (35 ^º)	Inlet	69	66	64	62	63	63	64	59	74
HB 40 T4 (A0:6) (40 ^º)	Inlet	73	69	68	66	66	66	66	62	77
HB 45 M4 (A0:6) (35 ^º)	Inlet	71	68	66	65	65	64	66	62	76
HB 45 M4 (A0:6) (40 ^º)	Inlet	73	70	68	67	66	66	67	62	78
HB 45 M4 (A5:6) (25 ^º)	Inlet	45	50	57	64	63	64	66	59	71
HB 45 M4 (A5:6) (30 ^º)	Inlet	48	53	60	64	66	67	68	59	73
HB 45 M4 (A5:6) (35 ^º)	Inlet	50	54	62	63	68	68	69	59	74
HB 45 M4 (A5:6) (40 ^º)	Inlet	53	56	65	66	70	70	71	62	76
HB 45 M4 (A5:6) (45 ^º)	Inlet	52	56	64	67	71	71	72	64	77
HB 45 T4 (A0:6) (35 ^º)	Inlet	71	68	66	65	65	64	66	62	76
HB 45 T4 (A0:6) (40 ^º)	Inlet	73	70	68	67	66	66	67	62	78
HB 45 T4 (A5:6) (25 ^º)	Inlet	45	50	57	64	63	64	66	59	71
HB 45 T4 (A5:6) (30 ^º)	Inlet	48	53	60	64	66	67	68	59	73
HB 45 T4 (A5:6) (35 ^º)	Inlet	50	54	62	63	68	68	69	59	74
HB 45 T4 (A5:6) (40 ^º)	Inlet	53	56	65	66	70	70	71	62	76
HB 45 T4 (A5:6) (45 ^º)	Inlet	52	56	64	67	71	71	72	64	77
HB 50 M4 (A0:6) (35 ^º)	Inlet	72	69	69	66	66	64	66	61	77
HB 50 M4 (A0:6) (40 ^º)	Inlet	75	72	70	68	69	67	68	63	79
HB 50 M4 (A5:6) (25 ^º)	Inlet	44	51	56	61	64	66	68	60	72

Sound power Lw dB (A)										
Model		63 Hz	125 Hz	250 Hz	500 Hz	1000 Hz	2000 Hz	4000 Hz	8000 Hz	Total
HB 50 M4 (A5:6) (30°)	Inlet	47	52	59	63	66	67	70	61	74
HB 50 M4 (A5:6) (35°)	Inlet	49	54	61	67	69	70	72	63	77
HB 50 M4 (A5:6) (40°)	Inlet	49	56	61	67	69	70	72	63	77
HB 50 M4 (A5:6) (45°)	Inlet	52	59	64	72	73	73	75	67	80
HB 50 T4 (A0:6) (35°)	Inlet	72	69	69	66	66	64	66	61	77
HB 50 T4 (A0:6) (40°)	Inlet	75	72	70	68	69	67	68	63	79
HB 50 T4 (A5:6) (25°)	Inlet	44	51	56	61	64	66	68	60	72
HB 50 T4 (A5:6) (30°)	Inlet	47	52	59	63	66	67	70	61	74
HB 50 T4 (A5:6) (35°)	Inlet	49	54	61	67	69	70	72	63	77
HB 50 T4 (A5:6) (40°)	Inlet	49	56	61	67	69	70	72	63	77
HB 50 T4 (A5:6) (45°)	Inlet	52	59	64	72	73	73	75	67	80
HB 56 M4 (A2:6) (20°)	Inlet	72	70	73	76	75	74	75	73	83
HB 56 M4 (A2:6) (25°)	Inlet	76	73	74	76	75	75	76	73	84
HB 56 M4 (A2:6) (27°)	Inlet	76	74	74	76	74	74	75	72	84
HB 56 M4 (A2:6) (30°)	Inlet	78	75	74	74	73	73	75	71	83
HB 56 M4 (A2:6) (33°)	Inlet	79	76	74	74	73	74	74	71	84
HB 56 M4 (A2:6) (35°)	Inlet	78	75	73	74	73	74	74	71	84
HB 56 M4 (A2:6) (37°)	Inlet	79	76	74	74	73	74	75	71	84
HB 56 M4 (A2:6) (40°)	Inlet	80	77	75	74	74	74	75	71	85
HB 56 M4 (A2:6) (43°)	Inlet	81	76	76	75	75	75	75	71	86
HB 56 M4 (A2:6) (45°)	Inlet	82	76	77	75	75	76	75	72	86
HB 56 M4 (A2:9) (20°)	Inlet	80	74	76	76	76	75	76	70	85
HB 56 M4 (A2:9) (25°)	Inlet	79	74	76	76	76	75	76	72	85
HB 56 M4 (A2:9) (27°)	Inlet	80	75	76	76	76	75	76	72	85
HB 56 M4 (A2:9) (30°)	Inlet	80	75	76	76	77	76	77	74	86
HB 56 M4 (A2:9) (33°)	Inlet	79	75	77	76	76	76	77	74	86
HB 56 M4 (A2:9) (35°)	Inlet	79	75	77	76	76	76	78	74	86
HB 56 M4 (A2:9) (37°)	Inlet	79	75	77	76	76	76	77	74	86
HB 56 M4 (A2:9) (40°)	Inlet	79	76	78	76	76	76	77	73	86
HB 56 M4 (A2:9) (43°)	Inlet	79	76	79	76	76	76	77	73	86
HB 56 M4 (A2:9) (45°)	Inlet	80	76	80	76	76	76	77	74	86
HB 56 M4 (A5:6) (20°)	Inlet	66	73	78	79	80	78	76	68	86
HB 56 M4 (A5:6) (25°)	Inlet	53	62	67	73	75	75	76	67	82
HB 56 M4 (A5:6) (30°)	Inlet	62	72	79	81	81	79	77	69	87
HB 56 M4 (A5:6) (35°)	Inlet	50	62	67	73	74	75	76	68	81
HB 56 M4 (A5:6) (40°)	Inlet	56	69	79	85	84	78	76	67	89
HB 56 M4 (A5:6) (45°)	Inlet	60	73	88	94	91	80	76	67	96
HB 56 T4 (A2:6) (20°)	Inlet	72	70	73	76	75	74	75	73	83
HB 56 T4 (A2:6) (25°)	Inlet	76	73	74	76	75	75	76	73	84

Sound power Lw dB (A)										
Model		63 Hz	125 Hz	250 Hz	500 Hz	1000 Hz	2000 Hz	4000 Hz	8000 Hz	Total
HB 56 T4 (A2:6) (27º)	Inlet	76	74	74	76	74	74	75	72	84
HB 56 T4 (A2:6) (30º)	Inlet	78	75	74	74	73	73	75	71	83
HB 56 T4 (A2:6) (33º)	Inlet	79	76	74	74	73	74	74	71	84
HB 56 T4 (A2:6) (35º)	Inlet	78	75	73	74	73	74	74	71	84
HB 56 T4 (A2:6) (37º)	Inlet	79	76	74	74	73	74	75	71	84
HB 56 T4 (A2:6) (40º)	Inlet	80	77	75	74	74	74	75	71	85
HB 56 T4 (A2:6) (43º)	Inlet	81	76	76	75	75	75	75	71	86
HB 56 T4 (A2:6) (45º)	Inlet	82	76	77	75	75	76	75	72	86
HB 56 T4 (A2:9) (20º)	Inlet	80	74	76	76	76	75	76	70	85
HB 56 T4 (A2:9) (25º)	Inlet	79	74	76	76	76	75	76	72	85
HB 56 T4 (A2:9) (27º)	Inlet	80	75	76	76	76	75	76	72	85
HB 56 T4 (A2:9) (30º)	Inlet	80	75	76	76	77	76	77	74	86
HB 56 T4 (A2:9) (33º)	Inlet	79	75	77	76	76	76	77	74	86
HB 56 T4 (A2:9) (35º)	Inlet	79	75	77	76	76	76	78	74	86
HB 56 T4 (A2:9) (37º)	Inlet	79	75	77	76	76	76	77	74	86
HB 56 T4 (A2:9) (40º)	Inlet	79	76	78	76	76	76	77	73	86
HB 56 T4 (A2:9) (43º)	Inlet	79	76	79	76	76	76	77	73	86
HB 56 T4 (A2:9) (45º)	Inlet	80	76	80	76	76	76	77	74	86
HB 56 T4 (A5:6) (20º)	Inlet	66	73	78	79	80	78	76	68	86
HB 56 T4 (A5:6) (25º)	Inlet	53	62	67	73	75	75	76	67	82
HB 56 T4 (A5:6) (30º)	Inlet	62	72	79	81	81	79	77	69	87
HB 56 T4 (A5:6) (35º)	Inlet	50	62	67	73	74	75	76	68	81
HB 56 T4 (A5:6) (40º)	Inlet	56	69	79	85	84	78	76	67	89
HB 56 T4 (A5:6) (45º)	Inlet	60	73	88	94	91	80	76	67	96
HB 63 M4 (A2:6) (20º)	Inlet	75	67	73	77	73	72	74	71	82
HB 63 M4 (A2:6) (25º)	Inlet	79	74	76	78	76	76	77	74	86
HB 63 M4 (A2:6) (27º)	Inlet	79	74	76	78	76	76	77	74	86
HB 63 M4 (A2:6) (30º)	Inlet	79	76	75	77	75	76	77	74	85
HB 63 M4 (A2:9) (20º)	Inlet	83	76	80	80	78	76	78	75	88
HB 63 M4 (A2:9) (25º)	Inlet	83	77	79	79	78	77	79	75	88
HB 63 M4 (A2:9) (27º)	Inlet	83	77	79	79	78	78	79	76	88
HB 63 M4 (A5:6) (20º)	Inlet	69	76	81	82	83	80	79	72	89
HB 63 M4 (A5:6) (25º)	Inlet	54	63	68	73	77	76	76	70	83
HB 63 T4 (A2:6) (20º)	Inlet	75	67	73	77	73	72	74	71	82
HB 63 T4 (A2:6) (25º)	Inlet	79	74	76	78	76	76	77	74	86
HB 63 T4 (A2:6) (27º)	Inlet	79	74	76	78	76	76	77	74	86
HB 63 T4 (A2:6) (30º)	Inlet	79	76	75	77	75	76	77	74	85
HB 63 T4 (A2:6) (33º)	Inlet	79	77	75	76	75	76	76	73	85
HB 63 T4 (A2:6) (35º)	Inlet	79	76	74	75	74	76	76	73	85

Sound power Lw dB (A)										
Model		63 Hz	125 Hz	250 Hz	500 Hz	1000 Hz	2000 Hz	4000 Hz	8000 Hz	Total
HB 63 T4 (A2:6) (37º)	Inlet	80	77	75	76	75	76	76	73	86
HB 63 T4 (A2:6) (40º)	Inlet	81	78	76	76	76	76	76	73	86
HB 63 T4 (A2:6) (43º)	Inlet	83	78	78	77	77	77	77	73	88
HB 63 T4 (A2:6) (45º)	Inlet	84	78	79	77	78	77	77	73	88
HB 63 T4 (A2:9) (20º)	Inlet	83	76	80	80	78	76	78	75	88
HB 63 T4 (A2:9) (25º)	Inlet	83	77	79	79	78	77	79	75	88
HB 63 T4 (A2:9) (27º)	Inlet	83	77	79	79	78	78	79	76	88
HB 63 T4 (A2:9) (30º)	Inlet	84	79	79	79	78	79	80	76	89
HB 63 T4 (A2:9) (33º)	Inlet	83	79	79	80	79	79	80	76	89
HB 63 T4 (A2:9) (35º)	Inlet	83	79	79	80	79	79	80	77	89
HB 63 T4 (A2:9) (37º)	Inlet	83	79	79	79	79	79	80	77	89
HB 63 T4 (A2:9) (40º)	Inlet	83	79	78	79	79	79	79	77	89
HB 63 T4 (A2:9) (43º)	Inlet	83	80	78	79	79	79	80	76	89
HB 63 T4 (A2:9) (45º)	Inlet	83	80	78	79	78	79	80	76	88
HB 63 T4 (A5:6) (20º)	Inlet	69	76	81	82	83	80	79	72	89
HB 63 T4 (A5:6) (25º)	Inlet	54	63	68	73	77	76	76	70	83
HB 63 T4 (A5:6) (30º)	Inlet	57	65	75	82	80	79	79	72	87
HB 63 T4 (A5:6) (35º)	Inlet	53	65	70	74	78	77	79	72	84
HB 63 T4 (A5:6) (40º)	Inlet	54	66	77	89	86	81	79	71	92
HB 63 T4 (A5:6) (45º)	Inlet	55	66	82	100	92	84	79	71	100
HB 71 M4 (A2:6) (20º)	Inlet	81	77	81	82	83	81	83	79	90
HB 71 M4 (A2:6) (25º)	Inlet	83	79	80	82	81	81	82	78	90
HB 71 M4 (A2:9) (20º)	Inlet	86	82	84	86	85	84	86	80	94
HB 71 M4 (A5:6) (20º)	Inlet	71	78	83	85	85	83	82	75	92
HB 71 T4 (A2:6) (20º)	Inlet	81	77	81	82	83	81	83	79	90
HB 71 T4 (A2:6) (25º)	Inlet	83	79	80	82	81	81	82	78	90
HB 71 T4 (A2:6) (27º)	Inlet	83	79	80	81	80	80	82	78	90
HB 71 T4 (A2:6) (30º)	Inlet	84	80	79	81	79	80	81	78	90
HB 71 T4 (A2:6) (33º)	Inlet	83	80	78	79	78	79	80	76	89
HB 71 T4 (A2:6) (35º)	Inlet	83	80	78	78	77	78	79	75	88
HB 71 T4 (A2:6) (37º)	Inlet	84	81	79	79	78	79	79	75	89
HB 71 T4 (A2:6) (40º)	Inlet	85	82	80	80	80	80	79	75	90
HB 71 T4 (A2:6) (43º)	Inlet	87	82	82	80	80	80	79	75	91
HB 71 T4 (A2:6) (45º)	Inlet	88	82	83	80	80	80	80	75	91
HB 71 T4 (A2:9) (20º)	Inlet	86	82	84	86	85	84	86	80	94
HB 71 T4 (A2:9) (25º)	Inlet	86	83	83	84	83	83	84	80	93
HB 71 T4 (A2:9) (27º)	Inlet	86	83	82	84	83	82	84	80	92
HB 71 T4 (A2:9) (30º)	Inlet	86	83	81	82	82	82	83	79	92
HB 71 T4 (A2:9) (33º)	Inlet	86	83	81	82	82	82	82	79	92

Sound power Lw dB (A)										
Model		63 Hz	125 Hz	250 Hz	500 Hz	1000 Hz	2000 Hz	4000 Hz	8000 Hz	Total
HB 71 T4 (A2:9) (35°)	Inlet	86	83	81	82	82	82	82	79	91
HB 71 T4 (A2:9) (37°)	Inlet	87	84	82	82	82	82	82	79	92
HB 71 T4 (A2:9) (40°)	Inlet	87	84	82	81	82	82	82	79	92
HB 71 T4 (A2:9) (43°)	Inlet	86	84	82	81	81	82	82	78	92
HB 71 T4 (A2:9) (45°)	Inlet	86	84	82	81	81	81	81	77	91
HB 71 T4 (A5:6) (20°)	Inlet	71	78	83	85	85	83	82	75	92
HB 71 T4 (A5:6) (25°)	Inlet	58	68	74	78	81	82	82	73	88
HB 71 T4 (A5:6) (30°)	Inlet	60	68	75	81	82	81	81	72	87
HB 71 T4 (A5:6) (35°)	Inlet	53	65	70	75	78	79	80	71	84
HB 71 T4 (A5:6) (40°)	Inlet	57	68	83	92	88	83	81	72	95
HB 71 T4 (A5:6) (45°)	Inlet	61	70	92	105	96	87	83	72	105
HB 80 T4 (A2:6) (20°)	Inlet	80	77	80	82	83	82	83	80	90
HB 80 T4 (A2:6) (25°)	Inlet	83	80	81	82	83	82	83	80	91
HB 80 T4 (A2:6) (27°)	Inlet	84	81	81	82	82	82	83	80	91
HB 80 T4 (A2:6) (30°)	Inlet	86	83	81	82	82	83	83	79	92
HB 80 T4 (A2:6) (33°)	Inlet	87	84	82	82	82	83	83	78	92
HB 80 T4 (A2:6) (35°)	Inlet	88	85	83	81	81	83	83	78	92
HB 80 T4 (A2:6) (37°)	Inlet	88	85	83	81	81	82	82	77	92
HB 80 T4 (A2:6) (40°)	Inlet	87	85	83	81	81	81	81	76	92
HB 80 T4 (A2:6) (43°)	Inlet	88	85	84	82	82	81	81	76	93
HB 80 T4 (A2:6) (45°)	Inlet	88	85	84	82	82	81	81	76	93
HB 80 T4 (A2:9) (20°)	Inlet	86	88	86	92	91	88	91	85	98
HB 80 T4 (A2:9) (25°)	Inlet	88	87	85	90	89	87	89	84	97
HB 80 T4 (A2:9) (27°)	Inlet	88	87	85	89	88	87	88	84	96
HB 80 T4 (A2:9) (30°)	Inlet	89	86	84	87	87	87	87	83	96
HB 80 T4 (A2:9) (33°)	Inlet	89	86	84	86	86	86	86	82	95
HB 80 T4 (A2:9) (35°)	Inlet	88	85	83	84	85	86	85	81	94
HB 80 T4 (A2:9) (37°)	Inlet	89	86	84	84	85	86	85	81	95
HB 80 T4 (A2:9) (40°)	Inlet	90	87	85	84	84	85	85	80	95
HB 80 T4 (A2:9) (43°)	Inlet	90	88	86	84	84	84	83	79	95
HB 80 T4 (A2:9) (45°)	Inlet	90	87	86	84	84	84	83	79	95
HB 80 T4 (A5:6) (20°)	Inlet	74	81	86	88	88	86	85	78	94
HB 80 T4 (A5:6) (25°)	Inlet	61	68	74	79	81	81	82	74	88
HB 80 T4 (A5:6) (30°)	Inlet	61	72	79	89	87	85	85	77	93
HB 80 T4 (A5:6) (35°)	Inlet	58	70	76	84	89	87	87	78	94
HB 80 T4 (A5:6) (40°)	Inlet	59	72	88	93	90	86	84	76	97
HB 90 T4 (A6:3) (20°)	Inlet	86	79	81	78	79	79	83	79	90
HB 90 T4 (A6:3) (22°)	Inlet	87	81	82	80	81	81	84	80	92
HB 90 T4 (A6:3) (24°)	Inlet	88	83	84	82	82	82	85	81	93

Sound power Lw dB (A)										
Model		63 Hz	125 Hz	250 Hz	500 Hz	1000 Hz	2000 Hz	4000 Hz	8000 Hz	Total
HB 90 T4 (A6:3) (26º)	Inlet	89	84	85	84	83	83	86	82	94
HB 90 T4 (A6:3) (28º)	Inlet	90	85	86	85	84	84	86	83	95
HB 90 T4 (A6:3) (30º)	Inlet	91	87	87	87	85	85	87	83	96
HB 90 T4 (A6:3) (32º)	Inlet	91	87	87	89	86	86	87	84	97
HB 90 T4 (A6:3) (34º)	Inlet	92	88	88	90	87	87	88	84	97
HB 90 T4 (A6:3) (36º)	Inlet	92	88	88	91	87	88	88	85	98
HB 90 T4 (A6:3) (38º)	Inlet	92	89	89	92	89	89	89	86	99
HB 90 T4 (A6:3) (40º)	Inlet	92	90	90	92	90	90	90	87	99
HB 90 T4 (A6:3) (42º)	Inlet	93	91	91	93	91	91	91	87	101
HB 90 T4 (A6:6) (20º)	Inlet	91	91	90	91	92	89	90	87	99
HB 90 T4 (A6:6) (22º)	Inlet	92	91	90	92	92	90	90	88	100
HB 90 T4 (A6:6) (24º)	Inlet	93	92	91	92	92	90	91	88	101
HB 90 T4 (A6:6) (26º)	Inlet	93	93	91	93	92	90	91	89	101
HB 90 T4 (A6:6) (28º)	Inlet	94	93	92	93	92	91	92	89	102
HB 90 T4 (A6:6) (30º)	Inlet	95	94	92	93	92	91	92	90	102
HB 90 T4 (A6:6) (32º)	Inlet	94	93	91	92	90	89	91	88	101
HB 90 T4 (A6:6) (34º)	Inlet	92	91	89	90	88	88	90	86	99
HB 90 T4 (A6:6) (36º)	Inlet	92	91	89	89	88	88	89	86	98
HB 90 T4 (A6:6) (38º)	Inlet	93	92	90	90	88	88	90	86	99
HB 90 T4 (A6:6) (40º)	Inlet	94	92	90	91	89	89	90	86	100
HB 90 T4 (A6:6) (42º)	Inlet	94	93	91	91	89	89	90	86	101
HB 100 T4 (A6:3) (20º)	Inlet	90	87	85	84	87	87	91	85	97
HB 100 T4 (A6:3) (22º)	Inlet	91	88	86	86	87	88	91	86	97
HB 100 T4 (A6:3) (24º)	Inlet	92	88	87	86	87	87	90	86	97
HB 100 T4 (A6:3) (26º)	Inlet	92	88	87	86	87	87	90	85	97
HB 100 T4 (A6:3) (28º)	Inlet	92	88	87	86	86	87	89	85	97
HB 100 T4 (A6:3) (30º)	Inlet	92	88	87	87	86	86	88	84	97
HB 100 T4 (A6:3) (32º)	Inlet	94	89	89	88	87	87	89	85	98
HB 100 T4 (A6:3) (34º)	Inlet	95	91	90	90	89	89	89	86	100
HB 100 T4 (A6:3) (36º)	Inlet	95	91	91	91	90	89	90	87	101
HB 100 T4 (A6:3) (38º)	Inlet	95	92	91	92	90	90	90	87	101
HB 100 T4 (A6:3) (40º)	Inlet	95	93	91	93	91	91	91	88	101
HB 100 T4 (A6:3) (42º)	Inlet	95	93	92	93	92	92	92	89	102
HB 100 T4 (A6:6) (20º)	Inlet	95	96	94	98	96	94	94	92	105
HB 100 T4 (A6:6) (22º)	Inlet	95	96	94	98	95	94	94	92	105
HB 100 T4 (A6:6) (24º)	Inlet	96	96	94	97	95	94	94	92	104
HB 100 T4 (A6:6) (26º)	Inlet	97	97	95	97	95	94	95	92	105
HB 100 T4 (A6:6) (28º)	Inlet	99	97	96	98	95	94	95	93	106
HB 100 T4 (A6:6) (30º)	Inlet	99	97	96	97	95	94	96	93	106

Sound power Lw dB (A)

Model		63 Hz	125 Hz	250 Hz	500 Hz	1000 Hz	2000 Hz	4000 Hz	8000 Hz	Total
HB 100 T4 (A6:6) (32 ^º)	Inlet	98	97	95	95	94	93	94	91	105
HB 100 T4 (A6:6) (34 ^º)	Inlet	98	96	95	93	92	92	93	90	104
HB 100 T4 (A6:6) (36 ^º)	Inlet	97	95	94	92	92	91	93	89	103
HB 100 T4 (A6:6) (38 ^º)	Inlet	98	96	95	93	92	92	93	90	104
HB 100 T4 (A6:6) (40 ^º)	Inlet	99	97	95	94	93	93	94	90	105
HB 100 T4 (A6:6) (42 ^º)	Inlet	98	96	95	94	93	93	94	90	104
HB 112 T4 (A6:3) (20 ^º)	Inlet	93	90	88	89	91	91	93	90	101
HB 112 T4 (A6:3) (22 ^º)	Inlet	95	92	90	90	92	92	94	91	102
HB 112 T4 (A6:3) (24 ^º)	Inlet	96	93	91	91	92	92	94	91	102
HB 112 T4 (A6:3) (26 ^º)	Inlet	97	93	92	92	92	92	95	91	103
HB 112 T4 (A6:3) (28 ^º)	Inlet	97	93	92	92	92	92	94	91	103
HB 112 T4 (A6:3) (30 ^º)	Inlet	97	93	92	92	92	91	94	91	103
HB 112 T4 (A6:3) (32 ^º)	Inlet	98	93	93	92	92	91	93	91	103
HB 112 T4 (A6:3) (34 ^º)	Inlet	99	93	94	93	92	91	93	91	103
HB 112 T4 (A6:3) (36 ^º)	Inlet	99	94	94	93	92	92	93	91	104
HB 112 T4 (A6:3) (38 ^º)	Inlet	99	95	94	94	93	92	93	91	104
HB 112 T4 (A6:3) (40 ^º)	Inlet	99	95	94	94	93	93	93	91	104
HB 112 T4 (A6:3) (42 ^º)	Inlet	99	96	94	95	94	94	94	91	104
HB 112 T4 (A6:6) (20 ^º)	Inlet	95	96	95	101	98	96	97	94	106
HB 112 T4 (A6:6) (22 ^º)	Inlet	96	96	95	99	98	96	97	94	106
HB 112 T4 (A6:6) (24 ^º)	Inlet	97	96	95	98	97	95	96	93	106
HB 112 T4 (A6:6) (26 ^º)	Inlet	98	97	95	98	97	96	97	93	106
HB 112 T4 (A6:6) (28 ^º)	Inlet	100	98	96	98	97	96	97	93	107
HB 112 T4 (A6:6) (30 ^º)	Inlet	101	98	96	97	96	96	97	92	107
HB 112 T4 (A6:6) (32 ^º)	Inlet	101	97	95	95	95	95	96	91	106
HB 112 T4 (A6:6) (34 ^º)	Inlet	100	97	95	94	94	94	95	90	105
HB 112 T4 (A6:6) (36 ^º)	Inlet	101	98	96	94	94	94	95	90	106
HB 112 T4 (A6:6) (38 ^º)	Inlet	103	99	98	95	96	96	97	92	107
HB 112 T4 (A6:6) (40 ^º)	Inlet	105	101	99	97	97	97	98	93	109
HB 112 T4 (A6:6) (42 ^º)	Inlet	105	100	99	97	97	97	97	93	109
HB 125 T4 (A7:4) (20 ^º)	Inlet	98	102	99	101	102	101	103	102	110
HB 125 T4 (A7:4) (22 ^º)	Inlet	101	103	101	102	102	102	104	102	111
HB 125 T4 (A7:4) (24 ^º)	Inlet	102	101	99	99	100	100	102	99	109
HB 125 T4 (A7:4) (26 ^º)	Inlet	102	100	98	97	98	98	99	96	108
HB 125 T4 (A7:4) (28 ^º)	Inlet	102	98	96	95	96	97	98	94	107
HB 125 T4 (A7:4) (30 ^º)	Inlet	100	97	95	93	94	95	96	91	105
HB 125 T4 (A7:4) (32 ^º)	Inlet	100	97	95	93	93	94	95	90	105
HB 125 T4 (A7:4) (34 ^º)	Inlet	99	96	94	93	93	94	95	89	105
HB 125 T4 (A7:4) (36 ^º)	Inlet	100	97	95	93	93	94	95	89	105

Sound power Lw dB (A)										
Model		63 Hz	125 Hz	250 Hz	500 Hz	1000 Hz	2000 Hz	4000 Hz	8000 Hz	Total
HB 125 T4 (A7:4) (38°)	Inlet	101	98	96	94	94	95	95	90	106
HB 125 T4 (A7:4) (40°)	Inlet	102	98	96	95	94	95	95	91	106
HB 125 T4 (A7:4) (42°)	Inlet	102	99	97	95	95	96	96	91	107
HB 125 T4 (A7:8) (20°)	Inlet	104	102	101	104	107	109	108	105	115
HB 125 T4 (A7:8) (22°)	Inlet	104	101	101	103	106	108	107	104	114
HB 125 T4 (A7:8) (24°)	Inlet	104	101	100	102	105	106	106	102	113
HB 125 T4 (A7:8) (26°)	Inlet	104	100	99	101	103	105	105	101	112
HB 125 T4 (A7:8) (28°)	Inlet	104	99	99	99	102	104	104	99	111
HB 125 T4 (A7:8) (30°)	Inlet	103	99	98	98	100	102	102	97	110
HB 125 T4 (A7:8) (32°)	Inlet	103	99	98	97	99	100	101	95	109
HB 125 T4 (A7:8) (34°)	Inlet	104	99	98	97	98	99	99	93	109
HB 125 T4 (A7:8) (36°)	Inlet	104	100	98	97	97	98	98	92	108
HB 125 T4 (A7:8) (38°)	Inlet	104	101	98	97	97	98	97	92	108
HB 125 T4 (A7:8) (40°)	Inlet	103	100	98	97	97	98	96	92	108
HB 125 T4 (A7:8) (42°)	Inlet	103	100	98	97	97	97	96	92	108

Sound / 6 poles

Sound power Lw dB (A)										
Model		63 Hz	125 Hz	250 Hz	500 Hz	1000 Hz	2000 Hz	4000 Hz	8000 Hz	Total
HB 35 T6 (A0:6) (35°)	Inlet	56	54	53	51	50	50	51	48	61
HB 35 T6 (A0:6) (40°)	Inlet	58	55	54	53	52	52	53	49	63
HB 40 T6 (A0:6) (35°)	Inlet	60	57	55	53	53	54	55	49	64
HB 40 T6 (A0:6) (40°)	Inlet	64	60	59	56	56	56	57	52	68
HB 45 T6 (A0:6) (35°)	Inlet	61	59	57	56	56	55	57	52	66
HB 45 T6 (A0:6) (40°)	Inlet	64	61	59	57	57	56	57	53	68
HB 45 T6 (A5:6) (25°)	Inlet	36	41	48	55	53	55	57	49	62
HB 45 T6 (A5:6) (30°)	Inlet	39	44	51	55	57	58	59	50	64
HB 45 T6 (A5:6) (35°)	Inlet	40	44	52	53	58	58	60	49	65
HB 45 T6 (A5:6) (40°)	Inlet	43	47	55	57	60	60	62	53	67
HB 45 T6 (A5:6) (45°)	Inlet	42	46	54	58	61	62	63	55	68
HB 50 T6 (A0:6) (35°)	Inlet	63	60	59	57	56	55	56	51	67
HB 50 T6 (A0:6) (40°)	Inlet	66	63	61	59	59	57	59	54	70
HB 50 T6 (A5:6) (25°)	Inlet	35	42	47	52	54	57	59	51	63
HB 50 T6 (A5:6) (30°)	Inlet	38	43	50	54	57	58	61	52	65
HB 50 T6 (A5:6) (35°)	Inlet	39	44	51	58	60	61	63	54	67
HB 50 T6 (A5:6) (40°)	Inlet	40	47	52	58	60	61	63	54	67
HB 50 T6 (A5:6) (45°)	Inlet	43	50	55	63	64	64	66	58	71

Sound power Lw dB (A)

Model		63 Hz	125 Hz	250 Hz	500 Hz	1000 Hz	2000 Hz	4000 Hz	8000 Hz	Total
HB 56 M6 (A2:6) (20º)	Inlet	63	61	63	67	65	65	66	63	73
HB 56 M6 (A2:6) (25º)	Inlet	66	64	65	67	66	65	66	63	75
HB 56 M6 (A2:6) (27º)	Inlet	67	64	65	66	65	65	66	63	74
HB 56 M6 (A2:6) (30º)	Inlet	68	65	64	64	64	64	65	61	74
HB 56 M6 (A2:6) (33º)	Inlet	69	66	64	64	63	64	65	62	74
HB 56 M6 (A2:6) (35º)	Inlet	69	66	64	64	63	64	65	62	74
HB 56 M6 (A2:6) (37º)	Inlet	70	67	65	65	64	65	65	61	75
HB 56 M6 (A2:6) (40º)	Inlet	71	68	66	65	64	65	66	61	75
HB 56 M6 (A2:6) (43º)	Inlet	72	67	67	65	65	66	66	62	76
HB 56 M6 (A2:6) (45º)	Inlet	73	66	68	66	66	66	66	62	77
HB 56 M6 (A2:9) (20º)	Inlet	70	65	66	67	67	66	66	61	76
HB 56 M6 (A2:9) (25º)	Inlet	70	65	66	67	67	66	67	62	76
HB 56 M6 (A2:9) (27º)	Inlet	70	65	67	67	67	66	67	63	76
HB 56 M6 (A2:9) (30º)	Inlet	70	66	67	67	67	67	68	64	76
HB 56 M6 (A2:9) (33º)	Inlet	70	65	67	67	67	67	68	64	76
HB 56 M6 (A2:9) (35º)	Inlet	69	65	67	67	67	67	68	64	76
HB 56 M6 (A2:9) (37º)	Inlet	69	66	68	67	67	66	68	64	76
HB 56 M6 (A2:9) (40º)	Inlet	70	66	68	66	67	66	67	64	76
HB 56 M6 (A2:9) (43º)	Inlet	70	66	70	67	67	67	67	64	77
HB 56 M6 (A2:9) (45º)	Inlet	70	67	70	67	67	67	67	64	77
HB 56 M6 (A5:6) (20º)	Inlet	63	70	75	76	77	75	73	65	82
HB 56 M6 (A5:6) (25º)	Inlet	50	59	64	70	72	72	73	64	78
HB 56 M6 (A5:6) (30º)	Inlet	58	68	75	77	78	76	74	66	83
HB 56 M6 (A5:6) (35º)	Inlet	47	58	63	69	70	71	72	64	78
HB 56 M6 (A5:6) (40º)	Inlet	53	66	76	81	81	75	73	64	85
HB 56 M6 (A5:6) (45º)	Inlet	57	69	84	90	88	77	73	63	93
HB 56 T6 (A2:6) (20º)	Inlet	63	61	63	67	65	65	66	63	73
HB 56 T6 (A2:6) (25º)	Inlet	66	64	65	67	66	65	66	63	75
HB 56 T6 (A2:6) (27º)	Inlet	67	64	65	66	65	65	66	63	74
HB 56 T6 (A2:6) (30º)	Inlet	68	65	64	64	64	64	65	61	74
HB 56 T6 (A2:6) (33º)	Inlet	69	66	64	64	63	64	65	62	74
HB 56 T6 (A2:6) (35º)	Inlet	69	66	64	64	63	64	65	62	74
HB 56 T6 (A2:6) (37º)	Inlet	70	67	65	65	64	65	65	61	75
HB 56 T6 (A2:6) (40º)	Inlet	71	68	66	65	64	65	66	61	75
HB 56 T6 (A2:6) (43º)	Inlet	72	67	67	65	65	66	66	62	76
HB 56 T6 (A2:6) (45º)	Inlet	73	66	68	66	66	66	66	62	77
HB 56 T6 (A2:9) (20º)	Inlet	70	65	66	67	67	66	66	61	76
HB 56 T6 (A2:9) (25º)	Inlet	70	65	66	67	67	66	67	62	76
HB 56 T6 (A2:9) (27º)	Inlet	70	65	67	67	67	66	67	63	76

Sound power Lw dB (A)										
Model		63 Hz	125 Hz	250 Hz	500 Hz	1000 Hz	2000 Hz	4000 Hz	8000 Hz	Total
HB 56 T6 (A2:9) (30º)	Inlet	70	66	67	67	67	67	68	64	76
HB 56 T6 (A2:9) (33º)	Inlet	70	65	67	67	67	67	68	64	76
HB 56 T6 (A2:9) (35º)	Inlet	69	65	67	67	67	67	68	64	76
HB 56 T6 (A2:9) (37º)	Inlet	69	66	68	67	67	66	68	64	76
HB 56 T6 (A2:9) (40º)	Inlet	70	66	68	66	67	66	67	64	76
HB 56 T6 (A2:9) (43º)	Inlet	70	66	70	67	67	67	67	64	77
HB 56 T6 (A2:9) (45º)	Inlet	70	67	70	67	67	67	67	64	77
HB 56 T6 (A5:6) (20º)	Inlet	63	70	75	76	77	75	73	65	82
HB 56 T6 (A5:6) (25º)	Inlet	50	59	64	70	72	72	73	64	78
HB 56 T6 (A5:6) (30º)	Inlet	58	68	75	77	78	76	74	66	83
HB 56 T6 (A5:6) (35º)	Inlet	47	58	63	69	70	71	72	64	78
HB 56 T6 (A5:6) (40º)	Inlet	53	66	76	81	81	75	73	64	85
HB 56 T6 (A5:6) (45º)	Inlet	57	69	84	90	88	77	73	63	93
HB 63 M6 (A2:6) (20º)	Inlet	65	58	63	67	64	63	65	61	73
HB 63 M6 (A2:6) (25º)	Inlet	69	64	67	69	67	67	68	65	76
HB 63 M6 (A2:6) (27º)	Inlet	69	65	66	68	67	67	68	65	76
HB 63 M6 (A2:6) (30º)	Inlet	70	67	66	67	66	67	67	65	76
HB 63 M6 (A2:6) (33º)	Inlet	70	67	65	67	65	67	67	64	76
HB 63 M6 (A2:6) (35º)	Inlet	70	67	65	66	65	66	67	63	75
HB 63 M6 (A2:6) (37º)	Inlet	71	68	66	66	66	67	67	63	76
HB 63 M6 (A2:6) (40º)	Inlet	72	68	67	67	66	67	67	63	77
HB 63 M6 (A2:6) (43º)	Inlet	74	69	69	68	68	68	68	64	78
HB 63 M6 (A2:6) (45º)	Inlet	75	69	70	68	68	68	68	64	79
HB 63 M6 (A2:9) (20º)	Inlet	74	66	70	70	69	67	69	66	79
HB 63 M6 (A2:9) (25º)	Inlet	74	67	69	70	69	68	69	66	79
HB 63 M6 (A2:9) (27º)	Inlet	74	68	69	70	69	68	70	66	79
HB 63 M6 (A2:9) (30º)	Inlet	74	69	69	70	69	69	70	67	79
HB 63 M6 (A2:9) (33º)	Inlet	74	69	70	70	69	69	70	67	79
HB 63 M6 (A2:9) (35º)	Inlet	73	70	70	70	69	70	71	67	79
HB 63 M6 (A2:9) (37º)	Inlet	74	70	69	70	69	70	70	67	79
HB 63 M6 (A2:9) (40º)	Inlet	74	70	69	69	69	69	70	67	79
HB 63 M6 (A2:9) (43º)	Inlet	73	70	68	69	69	69	70	67	79
HB 63 M6 (A2:9) (45º)	Inlet	73	70	68	69	69	69	70	67	79
HB 63 M6 (A5:6) (20º)	Inlet	66	73	78	79	80	77	76	69	85
HB 63 M6 (A5:6) (25º)	Inlet	51	60	65	70	74	73	73	67	79
HB 63 M6 (A5:6) (30º)	Inlet	54	62	72	79	77	76	76	69	83
HB 63 M6 (A5:6) (35º)	Inlet	50	62	67	71	75	74	76	69	81
HB 63 M6 (A5:6) (40º)	Inlet	51	63	74	86	83	78	76	68	88
HB 63 M6 (A5:6) (45º)	Inlet	52	63	79	96	88	81	76	67	97

Sound power Lw dB (A)

Model		63 Hz	125 Hz	250 Hz	500 Hz	1000 Hz	2000 Hz	4000 Hz	8000 Hz	Total
HB 63 T6 (A2:6) (20º)	Inlet	65	58	63	67	64	63	65	61	73
HB 63 T6 (A2:6) (25º)	Inlet	69	64	67	69	67	67	68	65	76
HB 63 T6 (A2:6) (27º)	Inlet	69	65	66	68	67	67	68	65	76
HB 63 T6 (A2:6) (30º)	Inlet	70	67	66	67	66	67	67	65	76
HB 63 T6 (A2:6) (33º)	Inlet	70	67	65	67	65	67	67	64	76
HB 63 T6 (A2:6) (35º)	Inlet	70	67	65	66	65	66	67	63	75
HB 63 T6 (A2:6) (37º)	Inlet	71	68	66	66	66	67	67	63	76
HB 63 T6 (A2:6) (40º)	Inlet	72	68	67	67	66	67	67	63	77
HB 63 T6 (A2:6) (43º)	Inlet	74	69	69	68	68	68	68	64	78
HB 63 T6 (A2:6) (45º)	Inlet	75	69	70	68	68	68	68	64	79
HB 63 T6 (A2:9) (20º)	Inlet	74	66	70	70	69	67	69	66	79
HB 63 T6 (A2:9) (25º)	Inlet	74	67	69	70	69	68	69	66	79
HB 63 T6 (A2:9) (27º)	Inlet	74	68	69	70	69	68	70	66	79
HB 63 T6 (A2:9) (30º)	Inlet	74	69	69	70	69	69	70	67	79
HB 63 T6 (A2:9) (33º)	Inlet	74	69	70	70	69	69	70	67	79
HB 63 T6 (A2:9) (35º)	Inlet	73	70	70	70	69	70	71	67	79
HB 63 T6 (A2:9) (37º)	Inlet	74	70	69	70	69	70	70	67	79
HB 63 T6 (A2:9) (40º)	Inlet	74	70	69	69	69	69	70	67	79
HB 63 T6 (A2:9) (43º)	Inlet	73	70	68	69	69	69	70	67	79
HB 63 T6 (A2:9) (45º)	Inlet	73	70	68	69	69	69	70	67	79
HB 63 T6 (A5:6) (20º)	Inlet	66	73	78	79	80	77	76	69	85
HB 63 T6 (A5:6) (25º)	Inlet	51	60	65	70	74	73	73	67	79
HB 63 T6 (A5:6) (30º)	Inlet	54	62	72	79	77	76	76	69	83
HB 63 T6 (A5:6) (35º)	Inlet	50	62	67	71	75	74	76	69	81
HB 63 T6 (A5:6) (40º)	Inlet	51	63	74	86	83	78	76	68	88
HB 63 T6 (A5:6) (45º)	Inlet	52	63	79	96	88	81	76	67	97
HB 71 M6 (A2:6) (20º)	Inlet	71	67	71	73	73	71	74	69	81
HB 71 M6 (A2:6) (25º)	Inlet	73	69	71	72	72	71	73	69	80
HB 71 M6 (A2:6) (27º)	Inlet	74	70	70	72	71	71	72	69	80
HB 71 M6 (A2:6) (30º)	Inlet	74	71	70	71	70	71	71	68	80
HB 71 M6 (A2:6) (33º)	Inlet	74	71	69	70	69	70	70	67	79
HB 71 M6 (A2:6) (35º)	Inlet	73	70	68	69	68	69	70	65	79
HB 71 M6 (A2:6) (37º)	Inlet	75	72	70	69	69	70	70	66	80
HB 71 M6 (A2:6) (40º)	Inlet	76	73	71	70	70	70	70	66	81
HB 71 M6 (A2:6) (43º)	Inlet	77	72	72	71	71	70	70	66	81
HB 71 M6 (A2:6) (45º)	Inlet	78	72	73	71	71	70	70	66	82
HB 71 M6 (A2:9) (20º)	Inlet	77	73	75	76	76	74	76	71	84
HB 71 M6 (A2:9) (25º)	Inlet	77	73	73	75	74	73	75	70	83
HB 71 M6 (A2:9) (27º)	Inlet	77	73	73	74	74	73	74	70	83

Sound power Lw dB (A)

Model		63 Hz	125 Hz	250 Hz	500 Hz	1000 Hz	2000 Hz	4000 Hz	8000 Hz	Total
HB 71 M6 (A2:9) (30º)	Inlet	77	73	72	73	72	72	73	70	82
HB 71 M6 (A2:9) (33º)	Inlet	76	73	71	73	73	73	73	70	82
HB 71 M6 (A2:9) (35º)	Inlet	76	73	71	73	73	73	73	69	82
HB 71 M6 (A2:9) (37º)	Inlet	77	74	72	72	73	73	73	69	83
HB 71 M6 (A2:9) (40º)	Inlet	78	75	73	72	73	73	73	69	83
HB 71 M6 (A2:9) (43º)	Inlet	77	74	73	72	72	72	72	68	82
HB 71 M6 (A2:9) (45º)	Inlet	77	74	72	72	72	72	72	68	82
HB 71 M6 (A5:6) (20º)	Inlet	68	75	80	82	82	80	79	72	88
HB 71 M6 (A5:6) (25º)	Inlet	55	65	71	75	78	79	79	70	84
HB 71 M6 (A5:6) (30º)	Inlet	57	65	71	77	78	78	77	68	84
HB 71 M6 (A5:6) (35º)	Inlet	49	61	66	71	74	75	76	67	81
HB 71 M6 (A5:6) (40º)	Inlet	54	64	79	89	85	80	78	68	91
HB 71 M6 (A5:6) (45º)	Inlet	57	66	88	101	92	83	79	69	102
HB 71 T6 (A2:6) (20º)	Inlet	71	67	71	73	73	71	74	69	81
HB 71 T6 (A2:6) (25º)	Inlet	73	69	71	72	72	71	73	69	80
HB 71 T6 (A2:6) (27º)	Inlet	74	70	70	72	71	71	72	69	80
HB 71 T6 (A2:6) (30º)	Inlet	74	71	70	71	70	71	71	68	80
HB 71 T6 (A2:6) (33º)	Inlet	74	71	69	70	69	70	70	67	79
HB 71 T6 (A2:6) (35º)	Inlet	73	70	68	69	68	69	70	65	79
HB 71 T6 (A2:6) (37º)	Inlet	75	72	70	69	69	70	70	66	80
HB 71 T6 (A2:6) (40º)	Inlet	76	73	71	70	70	70	70	66	81
HB 71 T6 (A2:6) (43º)	Inlet	77	72	72	71	71	70	70	66	81
HB 71 T6 (A2:6) (45º)	Inlet	78	72	73	71	71	70	70	66	82
HB 71 T6 (A2:9) (20º)	Inlet	77	73	75	76	76	74	76	71	84
HB 71 T6 (A2:9) (25º)	Inlet	77	73	73	75	74	73	75	70	83
HB 71 T6 (A2:9) (27º)	Inlet	77	73	73	74	74	73	74	70	83
HB 71 T6 (A2:9) (30º)	Inlet	77	73	72	73	72	72	73	70	82
HB 71 T6 (A2:9) (33º)	Inlet	76	73	71	73	73	73	73	70	82
HB 71 T6 (A2:9) (35º)	Inlet	76	73	71	73	73	73	73	69	82
HB 71 T6 (A2:9) (37º)	Inlet	77	74	72	72	73	73	73	69	83
HB 71 T6 (A2:9) (40º)	Inlet	78	75	73	72	73	73	73	69	83
HB 71 T6 (A2:9) (43º)	Inlet	77	74	73	72	72	72	72	68	82
HB 71 T6 (A2:9) (45º)	Inlet	77	74	72	72	72	72	72	68	82
HB 71 T6 (A5:6) (20º)	Inlet	68	75	80	82	82	80	79	72	88
HB 71 T6 (A5:6) (25º)	Inlet	55	65	71	75	78	79	79	70	84
HB 71 T6 (A5:6) (30º)	Inlet	57	65	71	77	78	78	77	68	84
HB 71 T6 (A5:6) (35º)	Inlet	49	61	66	71	74	75	76	67	81
HB 71 T6 (A5:6) (40º)	Inlet	54	64	79	89	85	80	78	68	91
HB 71 T6 (A5:6) (45º)	Inlet	57	66	88	101	92	83	79	69	102

Sound power Lw dB (A)										
Model		63 Hz	125 Hz	250 Hz	500 Hz	1000 Hz	2000 Hz	4000 Hz	8000 Hz	Total
HB 80 T6 (A2:6) (20°)	Inlet	71	68	71	73	74	72	74	71	81
HB 80 T6 (A2:6) (25°)	Inlet	74	71	71	73	73	73	74	70	82
HB 80 T6 (A2:6) (27°)	Inlet	75	72	71	73	73	73	74	70	82
HB 80 T6 (A2:6) (30°)	Inlet	76	73	71	72	72	73	74	69	82
HB 80 T6 (A2:6) (33°)	Inlet	77	74	72	72	72	73	74	69	83
HB 80 T6 (A2:6) (35°)	Inlet	78	75	73	72	72	73	73	68	83
HB 80 T6 (A2:6) (37°)	Inlet	79	76	74	72	72	72	72	68	83
HB 80 T6 (A2:6) (40°)	Inlet	78	76	74	72	72	72	71	67	83
HB 80 T6 (A2:6) (43°)	Inlet	78	76	75	72	72	72	72	67	83
HB 80 T6 (A2:6) (45°)	Inlet	79	76	75	73	73	72	72	67	83
HB 80 T6 (A2:9) (20°)	Inlet	76	78	77	83	82	79	81	75	89
HB 80 T6 (A2:9) (25°)	Inlet	78	78	76	80	79	78	79	74	87
HB 80 T6 (A2:9) (27°)	Inlet	79	78	76	79	79	78	79	74	87
HB 80 T6 (A2:9) (30°)	Inlet	80	77	75	77	77	77	78	74	86
HB 80 T6 (A2:9) (33°)	Inlet	80	77	75	76	77	77	77	73	86
HB 80 T6 (A2:9) (35°)	Inlet	79	76	74	75	76	76	76	72	85
HB 80 T6 (A2:9) (37°)	Inlet	80	77	75	75	75	76	75	71	85
HB 80 T6 (A2:9) (40°)	Inlet	81	78	76	74	75	76	75	71	85
HB 80 T6 (A2:9) (43°)	Inlet	81	78	76	74	74	75	74	70	85
HB 80 T6 (A2:9) (45°)	Inlet	80	78	77	74	74	74	74	70	85
HB 80 T6 (A5:6) (20°)	Inlet	71	78	83	85	85	83	82	75	91
HB 80 T6 (A5:6) (25°)	Inlet	58	65	71	76	78	78	79	71	84
HB 80 T6 (A5:6) (30°)	Inlet	58	69	76	86	84	82	82	74	90
HB 80 T6 (A5:6) (35°)	Inlet	55	67	73	81	86	84	84	75	90
HB 80 T6 (A5:6) (40°)	Inlet	56	69	85	90	87	83	81	73	93
HB 80 T6 (A5:6) (45°)	Inlet	56	70	93	96	87	82	79	71	98
HB 90 T6 (A6:3) (20°)	Inlet	77	70	72	68	70	70	73	69	81
HB 90 T6 (A6:3) (22°)	Inlet	78	72	73	70	71	71	74	70	82
HB 90 T6 (A6:3) (24°)	Inlet	79	73	74	72	73	73	75	71	84
HB 90 T6 (A6:3) (26°)	Inlet	80	75	75	74	74	74	76	72	85
HB 90 T6 (A6:3) (28°)	Inlet	81	76	76	76	75	75	77	73	86
HB 90 T6 (A6:3) (30°)	Inlet	82	77	77	78	76	76	78	74	87
HB 90 T6 (A6:3) (32°)	Inlet	82	78	78	79	77	77	78	74	87
HB 90 T6 (A6:3) (34°)	Inlet	82	78	78	80	77	77	78	75	88
HB 90 T6 (A6:3) (36°)	Inlet	82	79	79	81	78	78	79	75	88
HB 90 T6 (A6:3) (38°)	Inlet	83	80	80	82	79	79	80	76	89
HB 90 T6 (A6:3) (40°)	Inlet	83	81	81	83	80	81	81	77	90
HB 90 T6 (A6:3) (42°)	Inlet	83	82	81	83	81	82	81	78	91
HB 90 T6 (A6:6) (20°)	Inlet	82	81	80	82	83	80	80	78	90

Sound power Lw dB (A)										
Model		63 Hz	125 Hz	250 Hz	500 Hz	1000 Hz	2000 Hz	4000 Hz	8000 Hz	Total
HB 90 T6 (A6:6) (22º)	Inlet	82	82	81	82	83	80	81	78	90
HB 90 T6 (A6:6) (24º)	Inlet	83	83	82	83	83	81	82	79	91
HB 90 T6 (A6:6) (26º)	Inlet	84	83	82	83	83	81	82	79	91
HB 90 T6 (A6:6) (28º)	Inlet	85	84	82	84	83	81	83	80	92
HB 90 T6 (A6:6) (30º)	Inlet	85	84	83	84	82	81	83	80	92
HB 90 T6 (A6:6) (32º)	Inlet	84	83	81	82	80	80	82	78	91
HB 90 T6 (A6:6) (34º)	Inlet	83	82	80	80	79	79	80	77	89
HB 90 T6 (A6:6) (36º)	Inlet	83	81	79	80	78	78	80	76	89
HB 90 T6 (A6:6) (38º)	Inlet	83	82	80	81	79	79	80	77	90
HB 90 T6 (A6:6) (40º)	Inlet	84	83	81	81	79	79	81	77	90
HB 90 T6 (A6:6) (42º)	Inlet	84	84	82	82	80	80	81	77	91
HB 100 T6 (A6:3) (20º)	Inlet	81	78	76	75	77	78	81	76	87
HB 100 T6 (A6:3) (22º)	Inlet	82	79	77	76	78	78	82	76	88
HB 100 T6 (A6:3) (24º)	Inlet	82	79	77	77	78	78	81	76	88
HB 100 T6 (A6:3) (26º)	Inlet	82	79	77	77	77	78	80	76	88
HB 100 T6 (A6:3) (28º)	Inlet	82	79	77	77	77	77	79	75	87
HB 100 T6 (A6:3) (30º)	Inlet	82	79	77	77	77	77	79	75	87
HB 100 T6 (A6:3) (32º)	Inlet	84	80	79	79	78	78	79	76	89
HB 100 T6 (A6:3) (34º)	Inlet	86	81	81	81	79	79	80	77	90
HB 100 T6 (A6:3) (36º)	Inlet	86	82	82	82	80	80	80	77	91
HB 100 T6 (A6:3) (38º)	Inlet	86	83	82	82	81	81	81	78	91
HB 100 T6 (A6:3) (40º)	Inlet	86	83	82	83	82	81	82	79	92
HB 100 T6 (A6:3) (42º)	Inlet	86	84	82	84	83	82	82	79	92
HB 100 T6 (A6:6) (20º)	Inlet	85	86	84	89	87	85	85	83	95
HB 100 T6 (A6:6) (22º)	Inlet	86	86	84	88	86	84	85	82	95
HB 100 T6 (A6:6) (24º)	Inlet	86	86	85	88	86	84	85	82	95
HB 100 T6 (A6:6) (26º)	Inlet	88	87	86	88	86	85	85	83	95
HB 100 T6 (A6:6) (28º)	Inlet	89	88	87	88	86	85	86	83	96
HB 100 T6 (A6:6) (30º)	Inlet	90	88	87	88	86	85	86	83	96
HB 100 T6 (A6:6) (32º)	Inlet	89	87	86	86	84	84	85	82	95
HB 100 T6 (A6:6) (34º)	Inlet	88	86	85	84	83	82	84	81	94
HB 100 T6 (A6:6) (36º)	Inlet	88	86	85	83	82	82	83	80	93
HB 100 T6 (A6:6) (38º)	Inlet	89	87	85	84	83	83	84	80	94
HB 100 T6 (A6:6) (40º)	Inlet	89	87	86	85	84	84	85	81	95
HB 100 T6 (A6:6) (42º)	Inlet	89	87	86	85	84	83	84	81	95
HB 112 T6 (A6:3) (20º)	Inlet	84	81	79	80	82	82	84	81	91
HB 112 T6 (A6:3) (22º)	Inlet	85	82	80	81	82	82	84	81	92
HB 112 T6 (A6:3) (24º)	Inlet	86	83	81	82	83	83	85	82	93
HB 112 T6 (A6:3) (26º)	Inlet	87	84	82	82	83	83	85	82	93

Sound power Lw dB (A)										
Model		63 Hz	125 Hz	250 Hz	500 Hz	1000 Hz	2000 Hz	4000 Hz	8000 Hz	Total
HB 112 T6 (A6:3) (28°)	Inlet	88	84	83	83	83	83	85	82	93
HB 112 T6 (A6:3) (30°)	Inlet	88	83	83	83	82	82	84	81	93
HB 112 T6 (A6:3) (32°)	Inlet	89	84	84	83	82	82	84	81	93
HB 112 T6 (A6:3) (34°)	Inlet	89	84	84	83	83	82	84	81	94
HB 112 T6 (A6:3) (36°)	Inlet	89	84	85	84	83	82	84	81	94
HB 112 T6 (A6:3) (38°)	Inlet	90	85	85	84	83	83	84	82	94
HB 112 T6 (A6:3) (40°)	Inlet	89	85	84	85	84	83	84	81	94
HB 112 T6 (A6:3) (42°)	Inlet	89	86	84	85	84	84	84	82	95
HB 112 T6 (A6:6) (20°)	Inlet	86	87	85	91	89	86	88	85	96
HB 112 T6 (A6:6) (22°)	Inlet	87	87	86	90	88	86	87	84	96
HB 112 T6 (A6:6) (24°)	Inlet	87	87	85	89	87	86	87	83	96
HB 112 T6 (A6:6) (26°)	Inlet	89	88	86	89	87	86	87	83	96
HB 112 T6 (A6:6) (28°)	Inlet	91	88	86	89	87	87	88	83	97
HB 112 T6 (A6:6) (30°)	Inlet	91	88	86	88	87	87	87	83	97
HB 112 T6 (A6:6) (32°)	Inlet	91	88	86	86	85	86	87	82	96
HB 112 T6 (A6:6) (34°)	Inlet	91	88	86	84	84	85	86	81	95
HB 112 T6 (A6:6) (36°)	Inlet	91	88	86	84	85	85	86	81	96
HB 112 T6 (A6:6) (38°)	Inlet	93	90	88	86	86	86	87	82	97
HB 112 T6 (A6:6) (40°)	Inlet	95	91	90	88	88	88	88	84	99
HB 112 T6 (A6:6) (42°)	Inlet	95	91	90	88	87	87	88	83	99
HB 125 T6 (A7:4) (20°)	Inlet	88	92	90	91	92	91	93	92	101
HB 125 T6 (A7:4) (22°)	Inlet	91	93	91	92	92	92	94	92	102
HB 125 T6 (A7:4) (24°)	Inlet	92	91	89	90	90	90	92	90	100
HB 125 T6 (A7:4) (26°)	Inlet	92	90	88	88	88	89	90	87	98
HB 125 T6 (A7:4) (28°)	Inlet	92	89	87	86	87	87	88	85	97
HB 125 T6 (A7:4) (30°)	Inlet	90	87	85	84	85	85	86	82	95
HB 125 T6 (A7:4) (32°)	Inlet	90	87	85	84	84	85	86	81	95
HB 125 T6 (A7:4) (34°)	Inlet	90	87	85	83	84	84	85	80	95
HB 125 T6 (A7:4) (36°)	Inlet	90	87	85	84	84	85	85	80	95
HB 125 T6 (A7:4) (38°)	Inlet	91	88	86	85	85	86	86	81	96
HB 125 T6 (A7:4) (40°)	Inlet	92	89	87	85	85	86	86	81	96
HB 125 T6 (A7:4) (42°)	Inlet	92	89	87	86	85	87	86	82	97
HB 125 T6 (A7:8) (20°)	Inlet	94	92	91	94	98	99	98	95	106
HB 125 T6 (A7:8) (22°)	Inlet	94	92	91	93	96	98	98	94	105
HB 125 T6 (A7:8) (24°)	Inlet	94	91	90	92	95	96	96	92	103
HB 125 T6 (A7:8) (26°)	Inlet	94	90	90	91	94	95	95	91	102
HB 125 T6 (A7:8) (28°)	Inlet	94	90	89	90	92	94	94	90	102
HB 125 T6 (A7:8) (30°)	Inlet	93	89	89	88	91	92	92	88	100
HB 125 T6 (A7:8) (32°)	Inlet	94	89	89	88	89	91	91	86	99

Sound power Lw dB (A)										
Model		63 Hz	125 Hz	250 Hz	500 Hz	1000 Hz	2000 Hz	4000 Hz	8000 Hz	Total
HB 125 T6 (A7:8) (34°)	Inlet	94	90	89	88	88	89	89	84	99
HB 125 T6 (A7:8) (36°)	Inlet	94	91	89	88	88	89	88	83	99
HB 125 T6 (A7:8) (38°)	Inlet	94	91	89	88	88	89	88	83	99
HB 125 T6 (A7:8) (40°)	Inlet	94	91	89	87	87	88	87	83	98
HB 125 T6 (A7:8) (42°)	Inlet	93	90	88	87	87	88	86	82	98

Sound / 4/8 poles

Sound power Lw dB (A)										
Model		63 Hz	125 Hz	250 Hz	500 Hz	1000 Hz	2000 Hz	4000 Hz	8000 Hz	Total
HB 35 T4/T8 (A0:6) (750 RPM - 35°)	Inlet	50	47	46	44	44	43	45	41	55
HB 35 T4/T8 (A0:6) (750 RPM - 40°)	Inlet	51	49	48	46	45	45	46	42	56
HB 35 T4/T8 (A0:6) (1500 RPM - 35°)	Inlet	65	63	62	60	60	59	61	57	71
HB 35 T4/T8 (A0:6) (1500 RPM - 40°)	Inlet	67	65	64	62	61	61	62	58	72
HB 40 T4/T8 (A0:6) (750 RPM - 35°)	Inlet	53	50	48	46	47	47	48	43	58
HB 40 T4/T8 (A0:6) (750 RPM - 40°)	Inlet	57	53	52	50	50	50	50	46	61
HB 40 T4/T8 (A0:6) (1500 RPM - 35°)	Inlet	69	66	64	62	63	63	64	59	74
HB 40 T4/T8 (A0:6) (1500 RPM - 40°)	Inlet	73	69	68	66	66	66	66	62	77
HB 45 T4/T8 (A0:6) (750 RPM - 35°)	Inlet	55	52	50	49	49	49	51	46	60
HB 45 T4/T8 (A0:6) (750 RPM - 40°)	Inlet	57	54	52	51	51	50	51	46	62
HB 45 T4/T8 (A0:6) (1500 RPM - 35°)	Inlet	71	68	66	65	65	64	66	62	76
HB 45 T4/T8 (A0:6) (1500 RPM - 40°)	Inlet	73	70	68	67	66	66	67	62	78
HB 45 T4/T8 (A5:6) (750 RPM - 25°)	Inlet	29	34	41	48	47	48	50	43	55
HB 45 T4/T8 (A5:6) (750 RPM - 30°)	Inlet	32	37	44	48	50	51	52	43	57
HB 45 T4/T8 (A5:6) (750 RPM - 35°)	Inlet	34	38	46	47	52	52	53	43	58
HB 45 T4/T8 (A5:6) (750 RPM - 40°)	Inlet	37	40	49	50	54	54	55	46	60

Sound power Lw dB (A)										
Model		63 Hz	125 Hz	250 Hz	500 Hz	1000 Hz	2000 Hz	4000 Hz	8000 Hz	Total
HB 45 T4/T8 (A5:6) (750 RPM - 45°)	Inlet	36	40	48	51	55	55	56	48	61
HB 45 T4/T8 (A5:6) (1500 RPM - 25°)	Inlet	45	50	57	64	63	64	66	59	71
HB 45 T4/T8 (A5:6) (1500 RPM - 30°)	Inlet	48	53	60	64	66	67	68	59	73
HB 45 T4/T8 (A5:6) (1500 RPM - 35°)	Inlet	50	54	62	63	68	68	69	59	74
HB 45 T4/T8 (A5:6) (1500 RPM - 40°)	Inlet	53	56	65	66	70	70	71	62	76
HB 45 T4/T8 (A5:6) (1500 RPM - 45°)	Inlet	52	56	64	67	71	71	72	64	77
HB 50 T4/T8 (A0:6) (750 RPM - 35°)	Inlet	56	53	53	50	50	48	50	45	61
HB 50 T4/T8 (A0:6) (750 RPM - 40°)	Inlet	59	56	54	53	53	51	52	47	63
HB 50 T4/T8 (A0:6) (1500 RPM - 35°)	Inlet	72	69	69	66	66	64	66	61	77
HB 50 T4/T8 (A0:6) (1500 RPM - 40°)	Inlet	75	72	70	68	69	67	68	63	79
HB 50 T4/T8 (A5:6) (750 RPM - 25°)	Inlet	29	35	41	45	48	50	52	44	56
HB 50 T4/T8 (A5:6) (750 RPM - 30°)	Inlet	31	37	43	47	51	51	55	46	58
HB 50 T4/T8 (A5:6) (750 RPM - 35°)	Inlet	33	38	45	51	53	54	56	47	61
HB 50 T4/T8 (A5:6) (750 RPM - 40°)	Inlet	34	41	46	51	53	54	57	48	61
HB 50 T4/T8 (A5:6) (750 RPM - 45°)	Inlet	37	44	49	56	57	57	59	52	64
HB 50 T4/T8 (A5:6) (1500 RPM - 25°)	Inlet	44	51	56	61	64	66	68	60	72
HB 50 T4/T8 (A5:6) (1500 RPM - 30°)	Inlet	47	52	59	63	66	67	70	61	74
HB 50 T4/T8 (A5:6) (1500 RPM - 35°)	Inlet	49	54	61	67	69	70	72	63	77
HB 50 T4/T8 (A5:6) (1500 RPM - 40°)	Inlet	49	56	61	67	69	70	72	63	77
HB 50 T4/T8 (A5:6) (1500 RPM - 45°)	Inlet	52	59	64	72	73	73	75	67	80
HB 56 T4/T8 (A2:6) (750 RPM - 20°)	Inlet	56	54	57	60	59	58	59	57	67
HB 56 T4/T8 (A2:6) (750 RPM - 25°)	Inlet	60	58	59	60	59	59	60	57	68

Sound power Lw dB (A)										
Model		63 Hz	125 Hz	250 Hz	500 Hz	1000 Hz	2000 Hz	4000 Hz	8000 Hz	Total
HB 56 T4/T8 (A2:6) (750 RPM - 27°)	Inlet	60	58	58	60	59	58	60	56	68
HB 56 T4/T8 (A2:6) (750 RPM - 30°)	Inlet	62	59	58	58	57	57	59	55	67
HB 56 T4/T8 (A2:6) (750 RPM - 33°)	Inlet	63	60	58	58	57	58	59	55	68
HB 56 T4/T8 (A2:6) (750 RPM - 35°)	Inlet	62	59	57	58	57	58	59	55	68
HB 56 T4/T8 (A2:6) (750 RPM - 37°)	Inlet	63	60	58	58	57	58	59	55	68
HB 56 T4/T8 (A2:6) (750 RPM - 40°)	Inlet	64	61	59	59	58	59	59	55	69
HB 56 T4/T8 (A2:6) (750 RPM - 43°)	Inlet	66	60	61	59	59	59	59	55	70
HB 56 T4/T8 (A2:6) (750 RPM - 45°)	Inlet	66	60	61	59	59	60	59	56	70
HB 56 T4/T8 (A2:6) (1500 RPM - 20°)	Inlet	72	70	73	76	75	74	75	73	83
HB 56 T4/T8 (A2:6) (1500 RPM - 25°)	Inlet	76	73	74	76	75	75	76	73	84
HB 56 T4/T8 (A2:6) (1500 RPM - 27°)	Inlet	76	74	74	76	74	74	75	72	84
HB 56 T4/T8 (A2:6) (1500 RPM - 30°)	Inlet	78	75	74	74	73	73	75	71	83
HB 56 T4/T8 (A2:6) (1500 RPM - 33°)	Inlet	79	76	74	74	73	74	74	71	84
HB 56 T4/T8 (A2:6) (1500 RPM - 35°)	Inlet	78	75	73	74	73	74	74	71	84
HB 56 T4/T8 (A2:6) (1500 RPM - 37°)	Inlet	79	76	74	74	73	74	75	71	84
HB 56 T4/T8 (A2:6) (1500 RPM - 40°)	Inlet	80	77	75	74	74	74	75	71	85
HB 56 T4/T8 (A2:6) (1500 RPM - 43°)	Inlet	81	76	76	75	75	75	75	71	86
HB 56 T4/T8 (A2:6) (1500 RPM - 45°)	Inlet	82	76	77	75	75	76	75	72	86
HB 56 T4/T8 (A2:9) (750 RPM - 20°)	Inlet	64	58	60	61	60	59	60	54	69
HB 56 T4/T8 (A2:9) (750 RPM - 25°)	Inlet	63	58	60	60	60	59	60	56	69
HB 56 T4/T8 (A2:9) (750 RPM - 27°)	Inlet	64	59	60	60	60	60	61	56	69
HB 56 T4/T8 (A2:9) (750 RPM - 30°)	Inlet	64	59	60	60	61	60	61	58	70

Sound power Lw dB (A)										
Model		63 Hz	125 Hz	250 Hz	500 Hz	1000 Hz	2000 Hz	4000 Hz	8000 Hz	Total
HB 56 T4/T8 (A2:9) (750 RPM - 33°)	Inlet	63	59	61	60	61	60	62	58	70
HB 56 T4/T8 (A2:9) (750 RPM - 35°)	Inlet	63	59	61	60	60	60	62	58	70
HB 56 T4/T8 (A2:9) (750 RPM - 37°)	Inlet	63	59	61	60	60	60	61	58	70
HB 56 T4/T8 (A2:9) (750 RPM - 40°)	Inlet	63	60	62	60	60	60	61	57	70
HB 56 T4/T8 (A2:9) (750 RPM - 43°)	Inlet	63	60	63	60	60	60	61	58	70
HB 56 T4/T8 (A2:9) (750 RPM - 45°)	Inlet	64	60	64	60	60	60	61	58	70
HB 56 T4/T8 (A2:9) (1500 RPM - 20°)	Inlet	80	74	76	76	76	75	76	70	85
HB 56 T4/T8 (A2:9) (1500 RPM - 25°)	Inlet	79	74	76	76	76	75	76	72	85
HB 56 T4/T8 (A2:9) (1500 RPM - 27°)	Inlet	80	75	76	76	76	75	76	72	85
HB 56 T4/T8 (A2:9) (1500 RPM - 30°)	Inlet	80	75	76	76	77	76	77	74	86
HB 56 T4/T8 (A2:9) (1500 RPM - 33°)	Inlet	79	75	77	76	76	76	77	74	86
HB 56 T4/T8 (A2:9) (1500 RPM - 35°)	Inlet	79	75	77	76	76	76	78	74	86
HB 56 T4/T8 (A2:9) (1500 RPM - 37°)	Inlet	79	75	77	76	76	76	77	74	86
HB 56 T4/T8 (A2:9) (1500 RPM - 40°)	Inlet	79	76	78	76	76	76	77	73	86
HB 56 T4/T8 (A2:9) (1500 RPM - 43°)	Inlet	79	76	79	76	76	76	77	73	86
HB 56 T4/T8 (A2:9) (1500 RPM - 45°)	Inlet	80	76	80	76	76	76	77	74	86
HB 56 T4/T8 (A5:6) (750 RPM - 20°)	Inlet	50	57	62	63	64	62	60	52	70
HB 56 T4/T8 (A5:6) (750 RPM - 25°)	Inlet	37	46	51	57	59	59	60	51	66
HB 56 T4/T8 (A5:6) (750 RPM - 30°)	Inlet	46	56	63	65	65	63	61	53	71
HB 56 T4/T8 (A5:6) (750 RPM - 35°)	Inlet	34	46	51	57	58	59	60	52	65
HB 56 T4/T8 (A5:6) (750 RPM - 40°)	Inlet	40	53	63	69	68	62	60	51	73
HB 56 T4/T8 (A5:6) (750 RPM - 45°)	Inlet	45	57	72	78	75	64	60	51	81

Sound power Lw dB (A)										
Model		63 Hz	125 Hz	250 Hz	500 Hz	1000 Hz	2000 Hz	4000 Hz	8000 Hz	Total
HB 56 T4/T8 (A5:6) (1500 RPM - 20°)	Inlet	66	73	78	79	80	78	76	68	86
HB 56 T4/T8 (A5:6) (1500 RPM - 25°)	Inlet	53	62	67	73	75	75	76	67	82
HB 56 T4/T8 (A5:6) (1500 RPM - 30°)	Inlet	62	72	79	81	81	79	77	69	87
HB 56 T4/T8 (A5:6) (1500 RPM - 35°)	Inlet	50	62	67	73	74	75	76	68	81
HB 56 T4/T8 (A5:6) (1500 RPM - 40°)	Inlet	56	69	79	85	84	78	76	67	89
HB 56 T4/T8 (A5:6) (1500 RPM - 45°)	Inlet	60	73	88	94	91	80	76	67	96
HB 63 T4/T8 (A2:6) (750 RPM - 20°)	Inlet	59	52	57	61	58	56	58	55	67
HB 63 T4/T8 (A2:6) (750 RPM - 25°)	Inlet	63	58	60	62	60	60	61	58	70
HB 63 T4/T8 (A2:6) (750 RPM - 27°)	Inlet	63	58	60	62	60	60	61	58	70
HB 63 T4/T8 (A2:6) (750 RPM - 30°)	Inlet	63	60	60	61	60	60	61	58	70
HB 63 T4/T8 (A2:6) (750 RPM - 33°)	Inlet	63	61	59	60	59	60	61	57	69
HB 63 T4/T8 (A2:6) (750 RPM - 35°)	Inlet	63	60	58	59	58	60	60	57	69
HB 63 T4/T8 (A2:6) (750 RPM - 37°)	Inlet	64	61	59	60	59	60	60	57	70
HB 63 T4/T8 (A2:6) (750 RPM - 40°)	Inlet	66	62	61	61	60	61	61	57	70
HB 63 T4/T8 (A2:6) (750 RPM - 43°)	Inlet	68	62	63	61	61	61	61	57	72
HB 63 T4/T8 (A2:6) (750 RPM - 45°)	Inlet	68	62	63	62	62	61	61	57	72
HB 63 T4/T8 (A2:6) (1500 RPM - 20°)	Inlet	75	67	73	77	73	72	74	71	82
HB 63 T4/T8 (A2:6) (1500 RPM - 25°)	Inlet	79	74	76	78	76	76	77	74	86
HB 63 T4/T8 (A2:6) (1500 RPM - 27°)	Inlet	79	74	76	78	76	76	77	74	86
HB 63 T4/T8 (A2:6) (1500 RPM - 30°)	Inlet	79	76	75	77	75	76	77	74	85
HB 63 T4/T8 (A2:6) (1500 RPM - 33°)	Inlet	79	77	75	76	75	76	76	73	85
HB 63 T4/T8 (A2:6) (1500 RPM - 35°)	Inlet	79	76	74	75	74	76	76	73	85

Sound power Lw dB (A)										
Model		63 Hz	125 Hz	250 Hz	500 Hz	1000 Hz	2000 Hz	4000 Hz	8000 Hz	Total
HB 63 T4/T8 (A2:6) (1500 RPM - 37°)	Inlet	80	77	75	76	75	76	76	73	86
HB 63 T4/T8 (A2:6) (1500 RPM - 40°)	Inlet	81	78	76	76	76	76	76	73	86
HB 63 T4/T8 (A2:6) (1500 RPM - 43°)	Inlet	83	78	78	77	77	77	77	73	88
HB 63 T4/T8 (A2:6) (1500 RPM - 45°)	Inlet	84	78	79	77	78	77	77	73	88
HB 63 T4/T8 (A2:9) (750 RPM - 20°)	Inlet	67	60	64	64	63	61	62	59	72
HB 63 T4/T8 (A2:9) (750 RPM - 25°)	Inlet	67	61	63	63	62	61	63	59	72
HB 63 T4/T8 (A2:9) (750 RPM - 27°)	Inlet	67	61	63	63	62	62	63	60	72
HB 63 T4/T8 (A2:9) (750 RPM - 30°)	Inlet	68	63	63	64	62	63	64	61	73
HB 63 T4/T8 (A2:9) (750 RPM - 33°)	Inlet	67	63	63	64	63	63	64	61	73
HB 63 T4/T8 (A2:9) (750 RPM - 35°)	Inlet	67	63	63	64	63	63	64	61	73
HB 63 T4/T8 (A2:9) (750 RPM - 37°)	Inlet	67	63	63	63	63	63	64	61	73
HB 63 T4/T8 (A2:9) (750 RPM - 40°)	Inlet	67	64	62	63	63	63	64	61	73
HB 63 T4/T8 (A2:9) (750 RPM - 43°)	Inlet	67	64	62	63	63	63	64	60	73
HB 63 T4/T8 (A2:9) (750 RPM - 45°)	Inlet	67	64	62	63	63	63	64	60	73
HB 63 T4/T8 (A2:9) (1500 RPM - 20°)	Inlet	83	76	80	80	78	76	78	75	88
HB 63 T4/T8 (A2:9) (1500 RPM - 25°)	Inlet	83	77	79	79	78	77	79	75	88
HB 63 T4/T8 (A2:9) (1500 RPM - 27°)	Inlet	83	77	79	79	78	78	79	76	88
HB 63 T4/T8 (A2:9) (1500 RPM - 30°)	Inlet	84	79	79	79	78	79	80	76	89
HB 63 T4/T8 (A2:9) (1500 RPM - 33°)	Inlet	83	79	79	80	79	79	80	76	89
HB 63 T4/T8 (A2:9) (1500 RPM - 35°)	Inlet	83	79	79	80	79	79	80	77	89
HB 63 T4/T8 (A2:9) (1500 RPM - 37°)	Inlet	83	79	79	79	79	79	80	77	89
HB 63 T4/T8 (A2:9) (1500 RPM - 40°)	Inlet	83	79	78	79	79	79	79	77	89

Sound power Lw dB (A)										
Model		63 Hz	125 Hz	250 Hz	500 Hz	1000 Hz	2000 Hz	4000 Hz	8000 Hz	Total
HB 63 T4/T8 (A2:9) (1500 RPM - 43°)	Inlet	83	80	78	79	79	79	80	76	89
HB 63 T4/T8 (A2:9) (1500 RPM - 45°)	Inlet	83	80	78	79	78	79	80	76	88
HB 63 T4/T8 (A5:6) (750 RPM - 20°)	Inlet	53	60	65	66	67	64	63	56	73
HB 63 T4/T8 (A5:6) (750 RPM - 25°)	Inlet	39	48	53	58	62	61	61	54	67
HB 63 T4/T8 (A5:6) (750 RPM - 30°)	Inlet	41	49	59	66	64	63	63	56	71
HB 63 T4/T8 (A5:6) (750 RPM - 35°)	Inlet	37	49	54	58	62	61	63	56	68
HB 63 T4/T8 (A5:6) (750 RPM - 40°)	Inlet	38	50	62	73	70	65	63	55	76
HB 63 T4/T8 (A5:6) (750 RPM - 45°)	Inlet	39	50	67	84	76	68	63	55	85
HB 63 T4/T8 (A5:6) (1500 RPM - 20°)	Inlet	69	76	81	82	83	80	79	72	89
HB 63 T4/T8 (A5:6) (1500 RPM - 25°)	Inlet	54	63	68	73	77	76	76	70	83
HB 63 T4/T8 (A5:6) (1500 RPM - 30°)	Inlet	57	65	75	82	80	79	79	72	87
HB 63 T4/T8 (A5:6) (1500 RPM - 35°)	Inlet	53	65	70	74	78	77	79	72	84
HB 63 T4/T8 (A5:6) (1500 RPM - 40°)	Inlet	54	66	77	89	86	81	79	71	92
HB 63 T4/T8 (A5:6) (1500 RPM - 45°)	Inlet	55	66	82	100	92	84	79	71	100
HB 71 T4/T8 (A2:6) (750 RPM - 20°)	Inlet	65	61	65	66	67	65	67	63	74
HB 71 T4/T8 (A2:6) (750 RPM - 25°)	Inlet	67	63	64	66	65	65	66	63	74
HB 71 T4/T8 (A2:6) (750 RPM - 27°)	Inlet	67	63	64	65	65	64	66	62	74
HB 71 T4/T8 (A2:6) (750 RPM - 30°)	Inlet	68	64	63	65	63	64	65	62	74
HB 71 T4/T8 (A2:6) (750 RPM - 33°)	Inlet	67	64	62	63	62	63	64	60	73
HB 71 T4/T8 (A2:6) (750 RPM - 35°)	Inlet	67	64	62	62	61	63	63	59	72
HB 71 T4/T8 (A2:6) (750 RPM - 37°)	Inlet	68	65	63	63	63	63	63	59	73
HB 71 T4/T8 (A2:6) (750 RPM - 40°)	Inlet	69	66	64	64	64	64	63	59	74

Sound power Lw dB (A)										
Model		63 Hz	125 Hz	250 Hz	500 Hz	1000 Hz	2000 Hz	4000 Hz	8000 Hz	Total
HB 71 T4/T8 (A2:6) (750 RPM - 43°)	Inlet	71	66	66	64	64	64	64	59	75
HB 71 T4/T8 (A2:6) (750 RPM - 45°)	Inlet	72	66	67	64	64	64	64	59	75
HB 71 T4/T8 (A2:6) (1500 RPM - 20°)	Inlet	81	77	81	82	83	81	83	79	90
HB 71 T4/T8 (A2:6) (1500 RPM - 25°)	Inlet	83	79	80	82	81	81	82	78	90
HB 71 T4/T8 (A2:6) (1500 RPM - 27°)	Inlet	83	79	80	81	80	80	82	78	90
HB 71 T4/T8 (A2:6) (1500 RPM - 30°)	Inlet	84	80	79	81	79	80	81	78	90
HB 71 T4/T8 (A2:6) (1500 RPM - 33°)	Inlet	83	80	78	79	78	79	80	76	89
HB 71 T4/T8 (A2:6) (1500 RPM - 35°)	Inlet	83	80	78	78	77	78	79	75	88
HB 71 T4/T8 (A2:6) (1500 RPM - 37°)	Inlet	84	81	79	79	78	79	79	75	89
HB 71 T4/T8 (A2:6) (1500 RPM - 40°)	Inlet	85	82	80	80	80	80	79	75	90
HB 71 T4/T8 (A2:6) (1500 RPM - 43°)	Inlet	87	82	82	80	80	80	79	75	91
HB 71 T4/T8 (A2:6) (1500 RPM - 45°)	Inlet	88	82	83	80	80	80	80	75	91
HB 71 T4/T8 (A2:9) (750 RPM - 20°)	Inlet	70	67	69	70	69	68	70	65	78
HB 71 T4/T8 (A2:9) (750 RPM - 25°)	Inlet	70	67	67	68	68	67	68	64	77
HB 71 T4/T8 (A2:9) (750 RPM - 27°)	Inlet	70	67	66	68	67	66	68	64	76
HB 71 T4/T8 (A2:9) (750 RPM - 30°)	Inlet	70	67	65	66	66	66	67	63	76
HB 71 T4/T8 (A2:9) (750 RPM - 33°)	Inlet	70	67	65	66	66	66	67	63	76
HB 71 T4/T8 (A2:9) (750 RPM - 35°)	Inlet	70	67	65	66	66	67	66	63	76
HB 71 T4/T8 (A2:9) (750 RPM - 37°)	Inlet	71	68	66	66	66	67	66	63	76
HB 71 T4/T8 (A2:9) (750 RPM - 40°)	Inlet	72	68	67	66	66	67	67	63	76
HB 71 T4/T8 (A2:9) (750 RPM - 43°)	Inlet	71	68	66	66	66	66	66	62	76
HB 71 T4/T8 (A2:9) (750 RPM - 45°)	Inlet	70	68	66	66	65	66	66	61	75

Sound power Lw dB (A)										
Model		63 Hz	125 Hz	250 Hz	500 Hz	1000 Hz	2000 Hz	4000 Hz	8000 Hz	Total
HB 71 T4/T8 (A2:9) (1500 RPM - 20°)	Inlet	86	82	84	86	85	84	86	80	94
HB 71 T4/T8 (A2:9) (1500 RPM - 25°)	Inlet	86	83	83	84	83	83	84	80	93
HB 71 T4/T8 (A2:9) (1500 RPM - 27°)	Inlet	86	83	82	84	83	82	84	80	92
HB 71 T4/T8 (A2:9) (1500 RPM - 30°)	Inlet	86	83	81	82	82	82	83	79	92
HB 71 T4/T8 (A2:9) (1500 RPM - 33°)	Inlet	86	83	81	82	82	82	82	79	92
HB 71 T4/T8 (A2:9) (1500 RPM - 35°)	Inlet	86	83	81	82	82	82	82	79	91
HB 71 T4/T8 (A2:9) (1500 RPM - 37°)	Inlet	87	84	82	82	82	82	82	79	92
HB 71 T4/T8 (A2:9) (1500 RPM - 40°)	Inlet	87	84	82	81	82	82	82	79	92
HB 71 T4/T8 (A2:9) (1500 RPM - 43°)	Inlet	86	84	82	81	81	82	82	78	92
HB 71 T4/T8 (A2:9) (1500 RPM - 45°)	Inlet	86	84	82	81	81	81	81	77	91
HB 71 T4/T8 (A5:6) (750 RPM - 20°)	Inlet	56	63	68	70	70	68	67	60	76
HB 71 T4/T8 (A5:6) (750 RPM - 25°)	Inlet	43	52	58	62	65	66	66	57	72
HB 71 T4/T8 (A5:6) (750 RPM - 30°)	Inlet	44	53	59	65	66	66	65	56	72
HB 71 T4/T8 (A5:6) (750 RPM - 35°)	Inlet	37	49	54	59	62	63	64	55	69
HB 71 T4/T8 (A5:6) (750 RPM - 40°)	Inlet	41	52	67	76	72	68	66	56	79
HB 71 T4/T8 (A5:6) (750 RPM - 45°)	Inlet	45	54	76	89	80	71	67	56	90
HB 71 T4/T8 (A5:6) (1500 RPM - 20°)	Inlet	71	78	83	85	85	83	82	75	92
HB 71 T4/T8 (A5:6) (1500 RPM - 25°)	Inlet	58	68	74	78	81	82	82	73	88
HB 71 T4/T8 (A5:6) (1500 RPM - 30°)	Inlet	60	68	75	81	82	81	81	72	87
HB 71 T4/T8 (A5:6) (1500 RPM - 35°)	Inlet	53	65	70	75	78	79	80	71	84
HB 71 T4/T8 (A5:6) (1500 RPM - 40°)	Inlet	57	68	83	92	88	83	81	72	95
HB 71 T4/T8 (A5:6) (1500 RPM - 45°)	Inlet	61	70	92	105	96	87	83	72	105

Sound power Lw dB (A)										
Model		63 Hz	125 Hz	250 Hz	500 Hz	1000 Hz	2000 Hz	4000 Hz	8000 Hz	Total
HB 80 T4/T8 (A2:6) (750 RPM - 20°)	Inlet	64	61	64	67	67	66	67	65	75
HB 80 T4/T8 (A2:6) (750 RPM - 25°)	Inlet	68	65	65	66	67	66	68	64	75
HB 80 T4/T8 (A2:6) (750 RPM - 27°)	Inlet	69	65	65	66	66	67	68	64	75
HB 80 T4/T8 (A2:6) (750 RPM - 30°)	Inlet	70	67	65	66	66	67	67	63	76
HB 80 T4/T8 (A2:6) (750 RPM - 33°)	Inlet	71	68	66	66	66	67	67	63	76
HB 80 T4/T8 (A2:6) (750 RPM - 35°)	Inlet	72	69	67	66	66	67	67	62	77
HB 80 T4/T8 (A2:6) (750 RPM - 37°)	Inlet	72	69	67	65	65	66	66	61	77
HB 80 T4/T8 (A2:6) (750 RPM - 40°)	Inlet	72	69	67	65	65	65	65	60	76
HB 80 T4/T8 (A2:6) (750 RPM - 43°)	Inlet	72	70	68	66	66	65	65	60	77
HB 80 T4/T8 (A2:6) (750 RPM - 45°)	Inlet	72	70	69	66	66	65	65	60	77
HB 80 T4/T8 (A2:6) (1500 RPM - 20°)	Inlet	80	77	80	82	83	82	83	80	90
HB 80 T4/T8 (A2:6) (1500 RPM - 25°)	Inlet	83	80	81	82	83	82	83	80	91
HB 80 T4/T8 (A2:6) (1500 RPM - 27°)	Inlet	84	81	81	82	82	82	83	80	91
HB 80 T4/T8 (A2:6) (1500 RPM - 30°)	Inlet	86	83	81	82	82	83	83	79	92
HB 80 T4/T8 (A2:6) (1500 RPM - 33°)	Inlet	87	84	82	82	82	83	83	78	92
HB 80 T4/T8 (A2:6) (1500 RPM - 35°)	Inlet	88	85	83	81	81	83	83	78	92
HB 80 T4/T8 (A2:6) (1500 RPM - 37°)	Inlet	88	85	83	81	81	82	82	77	92
HB 80 T4/T8 (A2:6) (1500 RPM - 40°)	Inlet	87	85	83	81	81	81	81	76	92
HB 80 T4/T8 (A2:6) (1500 RPM - 43°)	Inlet	88	85	84	82	82	81	81	76	93
HB 80 T4/T8 (A2:6) (1500 RPM - 45°)	Inlet	88	85	84	82	82	81	81	76	93
HB 80 T4/T8 (A2:9) (750 RPM - 20°)	Inlet	70	72	70	76	75	73	75	69	82
HB 80 T4/T8 (A2:9) (750 RPM - 25°)	Inlet	72	71	69	74	73	71	73	68	81

Sound power Lw dB (A)										
Model		63 Hz	125 Hz	250 Hz	500 Hz	1000 Hz	2000 Hz	4000 Hz	8000 Hz	Total
HB 80 T4/T8 (A2:9) (750 RPM - 27°)	Inlet	73	71	69	73	72	71	73	68	81
HB 80 T4/T8 (A2:9) (750 RPM - 30°)	Inlet	74	71	69	71	71	71	71	67	80
HB 80 T4/T8 (A2:9) (750 RPM - 33°)	Inlet	73	70	68	70	70	70	70	66	79
HB 80 T4/T8 (A2:9) (750 RPM - 35°)	Inlet	73	70	68	68	69	70	69	65	78
HB 80 T4/T8 (A2:9) (750 RPM - 37°)	Inlet	73	70	68	68	69	70	69	65	79
HB 80 T4/T8 (A2:9) (750 RPM - 40°)	Inlet	74	71	69	68	68	69	69	64	79
HB 80 T4/T8 (A2:9) (750 RPM - 43°)	Inlet	74	72	70	68	68	68	68	64	79
HB 80 T4/T8 (A2:9) (750 RPM - 45°)	Inlet	74	71	70	68	68	68	67	63	79
HB 80 T4/T8 (A2:9) (1500 RPM - 20°)	Inlet	86	88	86	92	91	88	91	85	98
HB 80 T4/T8 (A2:9) (1500 RPM - 25°)	Inlet	88	87	85	90	89	87	89	84	97
HB 80 T4/T8 (A2:9) (1500 RPM - 27°)	Inlet	88	87	85	89	88	87	88	84	96
HB 80 T4/T8 (A2:9) (1500 RPM - 30°)	Inlet	89	86	84	87	87	87	87	83	96
HB 80 T4/T8 (A2:9) (1500 RPM - 33°)	Inlet	89	86	84	86	86	86	86	82	95
HB 80 T4/T8 (A2:9) (1500 RPM - 35°)	Inlet	88	85	83	84	85	86	85	81	94
HB 80 T4/T8 (A2:9) (1500 RPM - 37°)	Inlet	89	86	84	84	85	86	85	81	95
HB 80 T4/T8 (A2:9) (1500 RPM - 40°)	Inlet	90	87	85	84	84	85	85	80	95
HB 80 T4/T8 (A2:9) (1500 RPM - 43°)	Inlet	90	88	86	84	84	84	83	79	95
HB 80 T4/T8 (A2:9) (1500 RPM - 45°)	Inlet	90	87	86	84	84	84	83	79	95
HB 80 T4/T8 (A5:6) (750 RPM - 20°)	Inlet	58	65	70	72	72	70	69	62	79
HB 80 T4/T8 (A5:6) (750 RPM - 25°)	Inlet	45	52	58	63	65	65	66	58	72
HB 80 T4/T8 (A5:6) (750 RPM - 30°)	Inlet	45	57	64	73	71	69	69	61	78
HB 80 T4/T8 (A5:6) (750 RPM - 35°)	Inlet	42	54	60	68	73	71	71	62	78

Sound power Lw dB (A)										
Model		63 Hz	125 Hz	250 Hz	500 Hz	1000 Hz	2000 Hz	4000 Hz	8000 Hz	Total
HB 80 T4/T8 (A5:6) (750 RPM - 40°)	Inlet	43	56	72	77	74	70	68	60	81
HB 80 T4/T8 (A5:6) (750 RPM - 45°)	Inlet	44	58	81	84	75	70	66	59	86
HB 80 T4/T8 (A5:6) (1500 RPM - 20°)	Inlet	74	81	86	88	88	86	85	78	94
HB 80 T4/T8 (A5:6) (1500 RPM - 25°)	Inlet	61	68	74	79	81	81	82	74	88
HB 80 T4/T8 (A5:6) (1500 RPM - 30°)	Inlet	61	72	79	89	87	85	85	77	93
HB 80 T4/T8 (A5:6) (1500 RPM - 35°)	Inlet	58	70	76	84	89	87	87	78	94
HB 80 T4/T8 (A5:6) (1500 RPM - 40°)	Inlet	59	72	88	93	90	86	84	76	97
HB 80 T4/T8 (A5:6) (1500 RPM - 45°)	Inlet	60	74	97	100	91	86	82	75	102
HB 90 T4/T8 (A6:3) (750 RPM - 20°)	Inlet	70	64	65	62	63	64	67	63	74
HB 90 T4/T8 (A6:3) (750 RPM - 22°)	Inlet	71	65	66	64	65	65	68	64	76
HB 90 T4/T8 (A6:3) (750 RPM - 24°)	Inlet	73	67	68	66	66	66	69	65	77
HB 90 T4/T8 (A6:3) (750 RPM - 26°)	Inlet	73	68	69	68	67	67	70	66	78
HB 90 T4/T8 (A6:3) (750 RPM - 28°)	Inlet	74	70	70	70	68	68	70	67	79
HB 90 T4/T8 (A6:3) (750 RPM - 30°)	Inlet	75	71	71	71	70	70	71	67	80
HB 90 T4/T8 (A6:3) (750 RPM - 32°)	Inlet	75	71	71	73	70	70	72	68	81
HB 90 T4/T8 (A6:3) (750 RPM - 34°)	Inlet	76	72	72	74	71	71	72	68	81
HB 90 T4/T8 (A6:3) (750 RPM - 36°)	Inlet	76	73	72	75	72	72	72	69	82
HB 90 T4/T8 (A6:3) (750 RPM - 38°)	Inlet	76	74	73	76	73	73	73	70	83
HB 90 T4/T8 (A6:3) (750 RPM - 40°)	Inlet	76	74	74	77	74	74	74	71	84
HB 90 T4/T8 (A6:3) (750 RPM - 42°)	Inlet	77	75	75	77	75	75	75	72	85
HB 90 T4/T8 (A6:3) (1500 RPM - 20°)	Inlet	86	79	81	78	79	79	83	79	90
HB 90 T4/T8 (A6:3) (1500 RPM - 22°)	Inlet	87	81	82	80	81	81	84	80	92

Sound power Lw dB (A)										
Model		63 Hz	125 Hz	250 Hz	500 Hz	1000 Hz	2000 Hz	4000 Hz	8000 Hz	Total
HB 90 T4/T8 (A6:3) (1500 RPM - 24°)	Inlet	88	83	84	82	82	82	85	81	93
HB 90 T4/T8 (A6:3) (1500 RPM - 26°)	Inlet	89	84	85	84	83	83	86	82	94
HB 90 T4/T8 (A6:3) (1500 RPM - 28°)	Inlet	90	85	86	85	84	84	86	83	95
HB 90 T4/T8 (A6:3) (1500 RPM - 30°)	Inlet	91	87	87	87	85	85	87	83	96
HB 90 T4/T8 (A6:3) (1500 RPM - 32°)	Inlet	91	87	87	89	86	86	87	84	97
HB 90 T4/T8 (A6:3) (1500 RPM - 34°)	Inlet	92	88	88	90	87	87	88	84	97
HB 90 T4/T8 (A6:3) (1500 RPM - 36°)	Inlet	92	88	88	91	87	88	88	85	98
HB 90 T4/T8 (A6:3) (1500 RPM - 38°)	Inlet	92	89	89	92	89	89	89	86	99
HB 90 T4/T8 (A6:3) (1500 RPM - 40°)	Inlet	92	90	90	92	90	90	90	87	99
HB 90 T4/T8 (A6:3) (1500 RPM - 42°)	Inlet	93	91	91	93	91	91	91	87	101
HB 90 T4/T8 (A6:6) (750 RPM - 20°)	Inlet	75	75	74	76	76	73	74	71	84
HB 90 T4/T8 (A6:6) (750 RPM - 22°)	Inlet	76	75	74	76	76	74	74	72	84
HB 90 T4/T8 (A6:6) (750 RPM - 24°)	Inlet	77	76	75	77	76	74	75	72	85
HB 90 T4/T8 (A6:6) (750 RPM - 26°)	Inlet	78	77	76	77	76	75	76	73	85
HB 90 T4/T8 (A6:6) (750 RPM - 28°)	Inlet	78	77	76	77	76	75	76	73	86
HB 90 T4/T8 (A6:6) (750 RPM - 30°)	Inlet	79	78	76	78	76	75	76	74	86
HB 90 T4/T8 (A6:6) (750 RPM - 32°)	Inlet	78	77	75	76	74	74	75	72	85
HB 90 T4/T8 (A6:6) (750 RPM - 34°)	Inlet	76	75	73	74	72	72	74	70	83
HB 90 T4/T8 (A6:6) (750 RPM - 36°)	Inlet	76	75	73	73	72	72	73	70	82
HB 90 T4/T8 (A6:6) (750 RPM - 38°)	Inlet	77	76	74	74	72	72	74	70	83
HB 90 T4/T8 (A6:6) (750 RPM - 40°)	Inlet	78	76	74	75	73	73	74	70	84
HB 90 T4/T8 (A6:6) (750 RPM - 42°)	Inlet	78	77	75	75	73	73	75	71	85

Sound power Lw dB (A)										
Model		63 Hz	125 Hz	250 Hz	500 Hz	1000 Hz	2000 Hz	4000 Hz	8000 Hz	Total
HB 90 T4/T8 (A6:6) (1500 RPM - 20°)	Inlet	91	91	90	91	92	89	90	87	99
HB 90 T4/T8 (A6:6) (1500 RPM - 22°)	Inlet	92	91	90	92	92	90	90	88	100
HB 90 T4/T8 (A6:6) (1500 RPM - 24°)	Inlet	93	92	91	92	92	90	91	88	101
HB 90 T4/T8 (A6:6) (1500 RPM - 26°)	Inlet	93	93	91	93	92	90	91	89	101
HB 90 T4/T8 (A6:6) (1500 RPM - 28°)	Inlet	94	93	92	93	92	91	92	89	102
HB 90 T4/T8 (A6:6) (1500 RPM - 30°)	Inlet	95	94	92	93	92	91	92	90	102
HB 90 T4/T8 (A6:6) (1500 RPM - 32°)	Inlet	94	93	91	92	90	89	91	88	101
HB 90 T4/T8 (A6:6) (1500 RPM - 34°)	Inlet	92	91	89	90	88	88	90	86	99
HB 90 T4/T8 (A6:6) (1500 RPM - 36°)	Inlet	92	91	89	89	88	88	89	86	98
HB 90 T4/T8 (A6:6) (1500 RPM - 38°)	Inlet	93	92	90	90	88	88	90	86	99
HB 90 T4/T8 (A6:6) (1500 RPM - 40°)	Inlet	94	92	90	91	89	89	90	86	100
HB 90 T4/T8 (A6:6) (1500 RPM - 42°)	Inlet	94	93	91	91	89	89	90	86	101
HB 100 T4/T8 (A6:3) (750 RPM - 20°)	Inlet	74	71	69	68	71	71	75	69	81
HB 100 T4/T8 (A6:3) (750 RPM - 22°)	Inlet	75	72	70	70	71	72	75	70	82
HB 100 T4/T8 (A6:3) (750 RPM - 24°)	Inlet	76	72	71	70	71	72	75	70	82
HB 100 T4/T8 (A6:3) (750 RPM - 26°)	Inlet	76	72	71	70	71	71	74	69	81
HB 100 T4/T8 (A6:3) (750 RPM - 28°)	Inlet	76	72	71	71	71	71	73	69	81
HB 100 T4/T8 (A6:3) (750 RPM - 30°)	Inlet	76	72	71	71	70	70	72	68	81
HB 100 T4/T8 (A6:3) (750 RPM - 32°)	Inlet	78	73	73	73	72	72	73	69	82
HB 100 T4/T8 (A6:3) (750 RPM - 34°)	Inlet	79	75	74	74	73	73	73	70	84
HB 100 T4/T8 (A6:3) (750 RPM - 36°)	Inlet	80	75	75	75	74	73	74	71	85
HB 100 T4/T8 (A6:3) (750 RPM - 38°)	Inlet	79	76	75	76	74	74	74	72	85

Sound power Lw dB (A)										
Model		63 Hz	125 Hz	250 Hz	500 Hz	1000 Hz	2000 Hz	4000 Hz	8000 Hz	Total
HB 100 T4/T8 (A6:3) (750 RPM - 40°)	Inlet	79	77	75	77	75	75	75	72	85
HB 100 T4/T8 (A6:3) (750 RPM - 42°)	Inlet	79	77	76	77	76	76	76	73	86
HB 100 T4/T8 (A6:3) (1500 RPM - 20°)	Inlet	90	87	85	84	87	87	91	85	97
HB 100 T4/T8 (A6:3) (1500 RPM - 22°)	Inlet	91	88	86	86	87	88	91	86	97
HB 100 T4/T8 (A6:3) (1500 RPM - 24°)	Inlet	92	88	87	86	87	87	90	86	97
HB 100 T4/T8 (A6:3) (1500 RPM - 26°)	Inlet	92	88	87	86	87	87	90	85	97
HB 100 T4/T8 (A6:3) (1500 RPM - 28°)	Inlet	92	88	87	86	86	87	89	85	97
HB 100 T4/T8 (A6:3) (1500 RPM - 30°)	Inlet	92	88	87	87	86	86	88	84	97
HB 100 T4/T8 (A6:3) (1500 RPM - 32°)	Inlet	94	89	89	88	87	87	89	85	98
HB 100 T4/T8 (A6:3) (1500 RPM - 34°)	Inlet	95	91	90	90	89	89	89	86	100
HB 100 T4/T8 (A6:3) (1500 RPM - 36°)	Inlet	95	91	91	91	90	89	90	87	101
HB 100 T4/T8 (A6:3) (1500 RPM - 38°)	Inlet	95	92	91	92	90	90	90	87	101
HB 100 T4/T8 (A6:3) (1500 RPM - 40°)	Inlet	95	93	91	93	91	91	91	88	101
HB 100 T4/T8 (A6:3) (1500 RPM - 42°)	Inlet	95	93	92	93	92	92	92	89	102
HB 100 T4/T8 (A6:6) (750 RPM - 20°)	Inlet	79	80	78	82	80	78	78	76	89
HB 100 T4/T8 (A6:6) (750 RPM - 22°)	Inlet	79	80	78	82	79	78	78	76	89
HB 100 T4/T8 (A6:6) (750 RPM - 24°)	Inlet	80	80	78	81	79	78	78	76	88
HB 100 T4/T8 (A6:6) (750 RPM - 26°)	Inlet	81	81	79	82	79	78	79	76	89
HB 100 T4/T8 (A6:6) (750 RPM - 28°)	Inlet	83	81	80	82	79	79	80	77	90
HB 100 T4/T8 (A6:6) (750 RPM - 30°)	Inlet	83	81	81	81	79	78	80	77	90
HB 100 T4/T8 (A6:6) (750 RPM - 32°)	Inlet	83	81	80	79	78	77	78	75	89
HB 100 T4/T8 (A6:6) (750 RPM - 34°)	Inlet	82	80	79	77	76	76	77	74	88

Sound power Lw dB (A)										
Model		63 Hz	125 Hz	250 Hz	500 Hz	1000 Hz	2000 Hz	4000 Hz	8000 Hz	Total
HB 100 T4/T8 (A6:6) (750 RPM - 36°)	Inlet	81	79	78	76	76	75	77	73	87
HB 100 T4/T8 (A6:6) (750 RPM - 38°)	Inlet	82	80	79	77	77	76	77	74	88
HB 100 T4/T8 (A6:6) (750 RPM - 40°)	Inlet	83	81	79	78	77	77	78	74	89
HB 100 T4/T8 (A6:6) (750 RPM - 42°)	Inlet	83	81	79	78	77	77	78	74	88
HB 100 T4/T8 (A6:6) (1500 RPM - 20°)	Inlet	95	96	94	98	96	94	94	92	105
HB 100 T4/T8 (A6:6) (1500 RPM - 22°)	Inlet	95	96	94	98	95	94	94	92	105
HB 100 T4/T8 (A6:6) (1500 RPM - 24°)	Inlet	96	96	94	97	95	94	94	92	104
HB 100 T4/T8 (A6:6) (1500 RPM - 26°)	Inlet	97	97	95	97	95	94	95	92	105
HB 100 T4/T8 (A6:6) (1500 RPM - 28°)	Inlet	99	97	96	98	95	94	95	93	106
HB 100 T4/T8 (A6:6) (1500 RPM - 30°)	Inlet	99	97	96	97	95	94	96	93	106
HB 100 T4/T8 (A6:6) (1500 RPM - 32°)	Inlet	98	97	95	95	94	93	94	91	105
HB 100 T4/T8 (A6:6) (1500 RPM - 34°)	Inlet	98	96	95	93	92	92	93	90	104
HB 100 T4/T8 (A6:6) (1500 RPM - 36°)	Inlet	97	95	94	92	92	91	93	89	103
HB 100 T4/T8 (A6:6) (1500 RPM - 38°)	Inlet	98	96	95	93	92	92	93	90	104
HB 100 T4/T8 (A6:6) (1500 RPM - 40°)	Inlet	99	97	95	94	93	93	94	90	105
HB 100 T4/T8 (A6:6) (1500 RPM - 42°)	Inlet	98	96	95	94	93	93	94	90	104
HB 112 T4/T8 (A6:3) (750 RPM - 20°)	Inlet	78	75	73	74	75	75	78	74	85
HB 112 T4/T8 (A6:3) (750 RPM - 22°)	Inlet	79	76	74	75	76	76	78	75	86
HB 112 T4/T8 (A6:3) (750 RPM - 24°)	Inlet	80	77	75	75	76	76	79	75	86
HB 112 T4/T8 (A6:3) (750 RPM - 26°)	Inlet	81	77	76	76	76	76	79	76	87
HB 112 T4/T8 (A6:3) (750 RPM - 28°)	Inlet	81	77	76	76	76	76	78	75	87
HB 112 T4/T8 (A6:3) (750 RPM - 30°)	Inlet	81	77	76	76	76	75	78	75	87

Sound power Lw dB (A)										
Model		63 Hz	125 Hz	250 Hz	500 Hz	1000 Hz	2000 Hz	4000 Hz	8000 Hz	Total
HB 112 T4/T8 (A6:3) (750 RPM - 32°)	Inlet	82	77	77	77	76	75	78	75	87
HB 112 T4/T8 (A6:3) (750 RPM - 34°)	Inlet	83	77	78	77	76	75	77	75	87
HB 112 T4/T8 (A6:3) (750 RPM - 36°)	Inlet	83	78	78	77	76	76	77	75	88
HB 112 T4/T8 (A6:3) (750 RPM - 38°)	Inlet	83	79	78	78	77	77	77	75	88
HB 112 T4/T8 (A6:3) (750 RPM - 40°)	Inlet	83	79	78	78	77	77	77	75	88
HB 112 T4/T8 (A6:3) (750 RPM - 42°)	Inlet	83	80	78	79	78	78	78	75	88
HB 112 T4/T8 (A6:3) (1500 RPM - 20°)	Inlet	93	90	88	89	91	91	93	90	101
HB 112 T4/T8 (A6:3) (1500 RPM - 22°)	Inlet	95	92	90	90	92	92	94	91	102
HB 112 T4/T8 (A6:3) (1500 RPM - 24°)	Inlet	96	93	91	91	92	92	94	91	102
HB 112 T4/T8 (A6:3) (1500 RPM - 26°)	Inlet	97	93	92	92	92	92	95	91	103
HB 112 T4/T8 (A6:3) (1500 RPM - 28°)	Inlet	97	93	92	92	92	92	94	91	103
HB 112 T4/T8 (A6:3) (1500 RPM - 30°)	Inlet	97	93	92	92	92	91	94	91	103
HB 112 T4/T8 (A6:3) (1500 RPM - 32°)	Inlet	98	93	93	92	92	91	93	91	103
HB 112 T4/T8 (A6:3) (1500 RPM - 34°)	Inlet	99	93	94	93	92	91	93	91	103
HB 112 T4/T8 (A6:3) (1500 RPM - 36°)	Inlet	99	94	94	93	92	92	93	91	104
HB 112 T4/T8 (A6:3) (1500 RPM - 38°)	Inlet	99	95	94	94	93	92	93	91	104
HB 112 T4/T8 (A6:3) (1500 RPM - 40°)	Inlet	99	95	94	94	93	93	93	91	104
HB 112 T4/T8 (A6:3) (1500 RPM - 42°)	Inlet	99	96	94	95	94	94	94	91	104
HB 112 T4/T8 (A6:6) (750 RPM - 20°)	Inlet	79	80	79	85	82	80	81	78	90
HB 112 T4/T8 (A6:6) (750 RPM - 22°)	Inlet	80	81	79	84	82	80	81	78	90
HB 112 T4/T8 (A6:6) (750 RPM - 24°)	Inlet	81	80	79	83	81	79	80	77	90
HB 112 T4/T8 (A6:6) (750 RPM - 26°)	Inlet	83	81	79	82	81	80	81	77	90

Sound power Lw dB (A)										
Model		63 Hz	125 Hz	250 Hz	500 Hz	1000 Hz	2000 Hz	4000 Hz	8000 Hz	Total
HB 112 T4/T8 (A6:6) (750 RPM - 28°)	Inlet	84	82	80	82	81	80	81	77	91
HB 112 T4/T8 (A6:6) (750 RPM - 30°)	Inlet	85	82	80	81	80	80	81	76	91
HB 112 T4/T8 (A6:6) (750 RPM - 32°)	Inlet	85	82	80	80	79	79	80	75	90
HB 112 T4/T8 (A6:6) (750 RPM - 34°)	Inlet	84	81	79	78	78	78	79	74	89
HB 112 T4/T8 (A6:6) (750 RPM - 36°)	Inlet	85	82	80	78	78	79	79	74	90
HB 112 T4/T8 (A6:6) (750 RPM - 38°)	Inlet	87	83	82	80	80	80	81	76	91
HB 112 T4/T8 (A6:6) (750 RPM - 40°)	Inlet	89	85	83	81	81	81	82	77	93
HB 112 T4/T8 (A6:6) (750 RPM - 42°)	Inlet	89	84	83	81	81	81	81	77	93
HB 112 T4/T8 (A6:6) (1500 RPM - 20°)	Inlet	95	96	95	101	98	96	97	94	106
HB 112 T4/T8 (A6:6) (1500 RPM - 22°)	Inlet	96	96	95	99	98	96	97	94	106
HB 112 T4/T8 (A6:6) (1500 RPM - 24°)	Inlet	97	96	95	98	97	95	96	93	106
HB 112 T4/T8 (A6:6) (1500 RPM - 26°)	Inlet	98	97	95	98	97	96	97	93	106
HB 112 T4/T8 (A6:6) (1500 RPM - 28°)	Inlet	100	98	96	98	97	96	97	93	107
HB 112 T4/T8 (A6:6) (1500 RPM - 30°)	Inlet	101	98	96	97	96	96	97	92	107
HB 112 T4/T8 (A6:6) (1500 RPM - 32°)	Inlet	101	97	95	95	95	95	96	91	106
HB 112 T4/T8 (A6:6) (1500 RPM - 34°)	Inlet	100	97	95	94	94	94	95	90	105
HB 112 T4/T8 (A6:6) (1500 RPM - 36°)	Inlet	101	98	96	94	94	94	95	90	106
HB 112 T4/T8 (A6:6) (1500 RPM - 38°)	Inlet	103	99	98	95	96	96	97	92	107
HB 112 T4/T8 (A6:6) (1500 RPM - 40°)	Inlet	105	101	99	97	97	97	98	93	109
HB 112 T4/T8 (A6:6) (1500 RPM - 42°)	Inlet	105	100	99	97	97	97	97	93	109
HB 125 T4/T8 (A7:4) (750 RPM - 20°)	Inlet	82	86	83	85	86	85	87	86	94
HB 125 T4/T8 (A7:4) (750 RPM - 22°)	Inlet	85	87	85	86	86	86	88	86	95

Sound power Lw dB (A)										
Model		63 Hz	125 Hz	250 Hz	500 Hz	1000 Hz	2000 Hz	4000 Hz	8000 Hz	Total
HB 125 T4/T8 (A7:4) (750 RPM - 24°)	Inlet	86	85	83	83	84	84	86	83	93
HB 125 T4/T8 (A7:4) (750 RPM - 26°)	Inlet	86	84	82	81	82	82	83	81	92
HB 125 T4/T8 (A7:4) (750 RPM - 28°)	Inlet	86	82	80	80	80	81	82	78	91
HB 125 T4/T8 (A7:4) (750 RPM - 30°)	Inlet	84	81	79	77	78	79	80	75	89
HB 125 T4/T8 (A7:4) (750 RPM - 32°)	Inlet	84	81	79	77	78	78	79	74	89
HB 125 T4/T8 (A7:4) (750 RPM - 34°)	Inlet	83	80	78	77	77	78	79	73	89
HB 125 T4/T8 (A7:4) (750 RPM - 36°)	Inlet	84	81	79	78	77	78	79	73	89
HB 125 T4/T8 (A7:4) (750 RPM - 38°)	Inlet	85	82	80	79	78	79	80	74	90
HB 125 T4/T8 (A7:4) (750 RPM - 40°)	Inlet	86	82	80	79	78	79	80	75	90
HB 125 T4/T8 (A7:4) (750 RPM - 42°)	Inlet	86	83	81	80	79	80	80	76	91
HB 125 T4/T8 (A7:4) (1500 RPM - 20°)	Inlet	98	102	99	101	102	101	103	102	110
HB 125 T4/T8 (A7:4) (1500 RPM - 22°)	Inlet	101	103	101	102	102	102	104	102	111
HB 125 T4/T8 (A7:4) (1500 RPM - 24°)	Inlet	102	101	99	99	100	100	102	99	109
HB 125 T4/T8 (A7:4) (1500 RPM - 26°)	Inlet	102	100	98	97	98	98	99	96	108
HB 125 T4/T8 (A7:4) (1500 RPM - 28°)	Inlet	102	98	96	95	96	97	98	94	107
HB 125 T4/T8 (A7:4) (1500 RPM - 30°)	Inlet	100	97	95	93	94	95	96	91	105
HB 125 T4/T8 (A7:4) (1500 RPM - 32°)	Inlet	100	97	95	93	93	94	95	90	105
HB 125 T4/T8 (A7:4) (1500 RPM - 34°)	Inlet	99	96	94	93	93	94	95	89	105
HB 125 T4/T8 (A7:4) (1500 RPM - 36°)	Inlet	100	97	95	93	93	94	95	89	105
HB 125 T4/T8 (A7:4) (1500 RPM - 38°)	Inlet	101	98	96	94	94	95	95	90	106
HB 125 T4/T8 (A7:4) (1500 RPM - 40°)	Inlet	102	98	96	95	94	95	95	91	106
HB 125 T4/T8 (A7:4) (1500 RPM - 42°)	Inlet	102	99	97	95	95	96	96	91	107

Sound power Lw dB (A)										
Model		63 Hz	125 Hz	250 Hz	500 Hz	1000 Hz	2000 Hz	4000 Hz	8000 Hz	Total
HB 125 T4/T8 (A7:8) (750 RPM - 20°)	Inlet	88	86	85	88	91	93	92	89	99
HB 125 T4/T8 (A7:8) (750 RPM - 22°)	Inlet	88	85	85	87	90	92	91	88	98
HB 125 T4/T8 (A7:8) (750 RPM - 24°)	Inlet	88	85	84	86	89	90	90	86	97
HB 125 T4/T8 (A7:8) (750 RPM - 26°)	Inlet	88	84	83	85	87	89	89	85	96
HB 125 T4/T8 (A7:8) (750 RPM - 28°)	Inlet	88	84	83	83	86	88	88	83	95
HB 125 T4/T8 (A7:8) (750 RPM - 30°)	Inlet	87	83	82	82	84	86	86	81	94
HB 125 T4/T8 (A7:8) (750 RPM - 32°)	Inlet	87	83	82	82	83	84	85	79	93
HB 125 T4/T8 (A7:8) (750 RPM - 34°)	Inlet	88	84	82	81	82	83	83	77	93
HB 125 T4/T8 (A7:8) (750 RPM - 36°)	Inlet	88	84	83	81	81	82	82	77	92
HB 125 T4/T8 (A7:8) (750 RPM - 38°)	Inlet	88	85	83	81	81	82	81	76	92
HB 125 T4/T8 (A7:8) (750 RPM - 40°)	Inlet	87	84	82	81	81	82	80	76	92
HB 125 T4/T8 (A7:8) (750 RPM - 42°)	Inlet	87	84	82	81	81	81	80	76	92
HB 125 T4/T8 (A7:8) (1500 RPM - 20°)	Inlet	104	102	101	104	107	109	108	105	115
HB 125 T4/T8 (A7:8) (1500 RPM - 22°)	Inlet	104	101	101	103	106	108	107	104	114
HB 125 T4/T8 (A7:8) (1500 RPM - 24°)	Inlet	104	101	100	102	105	106	106	102	113
HB 125 T4/T8 (A7:8) (1500 RPM - 26°)	Inlet	104	100	99	101	103	105	105	101	112
HB 125 T4/T8 (A7:8) (1500 RPM - 28°)	Inlet	104	99	99	99	102	104	104	99	111
HB 125 T4/T8 (A7:8) (1500 RPM - 30°)	Inlet	103	99	98	98	100	102	102	97	110
HB 125 T4/T8 (A7:8) (1500 RPM - 32°)	Inlet	103	99	98	97	99	100	101	95	109
HB 125 T4/T8 (A7:8) (1500 RPM - 34°)	Inlet	104	99	98	97	98	99	99	93	109
HB 125 T4/T8 (A7:8) (1500 RPM - 36°)	Inlet	104	100	98	97	97	98	98	92	108
HB 125 T4/T8 (A7:8) (1500 RPM - 38°)	Inlet	104	101	98	97	97	98	97	92	108

Sound power Lw dB (A)										
Model		63 Hz	125 Hz	250 Hz	500 Hz	1000 Hz	2000 Hz	4000 Hz	8000 Hz	Total
HB 125 T4/T8 (A7:8) (1500 RPM - 40°)	Inlet	103	100	98	97	97	98	96	92	108
HB 125 T4/T8 (A7:8) (1500 RPM - 42°)	Inlet	103	100	98	97	97	97	96	92	108

erp data

ERP	
Fan type	Axial fan
Installation category	A
Efficiency category	Static
The fan has to be installed with FSC	No

ERP / 2 poles

Model	Motor power (kW)	Maximum efficiency point data						
		Max. efficiency (%)	Efficiency grade (N) (N)	Air Flow (m3/h)	Ps (Pa)	Pabs (kW)	speed (rpm)	Specific ratio
HB 35 M2 (A0:6) (25º)	0,55	36,51	44,05	2.829,94	295,12	0,64	-	1,00

ERP / 4 poles

Model	Motor power (kW)	Maximum efficiency point data						
		Max. efficiency (%)	Efficiency grade (N) (N)	Air Flow (m3/h)	Ps (Pa)	Pabs (kW)	speed (rpm)	Specific ratio
HB 35 M4 (A0:6) (35º)	0,12	27,54	38,54	1.997,21	90,99	0,18	-	1,00
HB 35 M4 (A0:6) (40º)	0,12	26,76	37,45	2.141,46	92,67	0,20	-	1,00
HB 35 T4 (A0:6) (35º)	0,12	32,95	44,44	1.997,21	90,99	0,15	-	1,00
HB 35 T4 (A0:6) (40º)	0,12	31,26	42,37	2.141,46	92,67	0,18	-	1,00
HB 40 M4 (A0:6) (35º)	0,18	29,85	39,92	2.668,81	102,89	0,26	-	1,00
HB 40 M4 (A0:6) (40º)	0,18	29,48	39,18	2.878,36	107,65	0,29	-	1,00
HB 40 T4 (A0:6) (35º)	0,18	37,99	48,72	2.668,81	102,89	0,20	-	1,00
HB 40 T4 (A0:6) (40º)	0,18	36,08	46,34	2.878,36	107,65	0,24	-	1,00
HB 45 M4 (A0:6) (35º)	0,25	30,99	40,16	3.702,84	106,29	0,36	-	1,00
HB 45 M4 (A0:6) (40º)	0,25	31,57	40,33	4.049,07	115,97	0,41	-	1,00
HB 45 M4 (A5:6) (25º)	0,25	25,20	34,85	2.807,25	95,89	0,30	-	1,00
HB 45 M4 (A5:6) (30º)	0,25	26,02	35,21	3.214,30	102,62	0,35	-	1,00
HB 45 M4 (A5:6) (35º)	0,37	24,66	33,29	3.695,82	104,82	0,43	-	1,00
HB 45 T4 (A0:6) (35º)	0,25	39,37	49,19	3.702,84	106,29	0,28	-	1,00
HB 45 T4 (A0:6) (40º)	0,25	38,70	48,01	4.049,07	115,97	0,34	-	1,00
HB 45 T4 (A5:6) (25º)	0,25	33,59	44,03	2.807,25	95,89	0,22	-	1,00
HB 45 T4 (A5:6) (30º)	0,25	33,08	42,93	3.214,30	102,62	0,28	-	1,00
HB 45 T4 (A5:6) (35º)	0,37	31,47	40,77	3.695,82	104,82	0,34	-	1,00
HB 45 T4 (A5:6) (40º)	0,37	28,36	37,13	4.124,29	102,56	0,41	-	1,00
HB 50 M4 (A0:6) (35º)	0,37	33,57	42,06	4.442,56	123,26	0,45	-	1,00

Model	Motor power (kW)	Maximum efficiency point data						
		Max. efficiency (%)	Efficiency grade (N) (N)	Air Flow (m3/h)	Ps (Pa)	Pabs (kW)	speed (rpm)	Specific ratio
HB 50 M4 (A0:6) (40º)	0,37	33,54	41,56	5.154,60	125,37	0,54	-	1,00
HB 50 M4 (A5:6) (25º)	0,25	30,21	39,16	3.820,69	109,57	0,39	-	1,00
HB 50 M4 (A5:6) (30º)	0,37	29,53	37,84	4.377,18	118,42	0,49	-	1,00
HB 50 T4 (A0:6) (35º)	0,37	42,23	51,35	4.442,56	123,26	0,36	-	1,00
HB 50 T4 (A0:6) (40º)	0,37	41,53	50,14	5.154,60	125,37	0,44	-	1,00
HB 50 T4 (A5:6) (25º)	0,25	37,58	47,13	3.820,69	109,57	0,31	-	1,00
HB 50 T4 (A5:6) (30º)	0,37	36,68	45,59	4.377,18	118,42	0,39	-	1,00
HB 50 T4 (A5:6) (35º)	0,55	34,41	42,75	4.997,36	120,39	0,48	-	1,00
HB 50 T4 (A5:6) (40º)	0,55	30,35	38,15	5.685,65	115,53	0,59	-	1,00
HB 56 M4 (A2:6) (20º)	0,37	34,46	42,57	4.266,24	151,17	0,52	-	1,00
HB 56 M4 (A5:6) (20º)	0,37	36,49	44,51	4.495,62	156,81	0,54	-	1,00
HB 56 T4 (A2:6) (20º)	0,37	42,66	51,36	4.266,24	151,17	0,42	-	1,00
HB 56 T4 (A2:6) (25º)	0,55	44,74	52,63	5.406,36	167,16	0,57	-	1,00
HB 56 T4 (A2:6) (27,5º)	0,55	44,13	51,78	5.683,27	171,50	0,62	-	1,00
HB 56 T4 (A2:6) (30º)	0,75	43,31	50,46	6.312,70	182,48	0,74	-	1,00
HB 56 T4 (A2:6) (32,5º)	0,75	41,54	48,32	6.816,48	186,16	0,85	-	1,00
HB 56 T4 (A2:6) (35º)	1,10	40,81	47,28	7.342,60	190,02	0,95	-	1,00
HB 56 T4 (A2:6) (37,5º)	1,10	40,23	46,45	7.862,73	190,73	1,04	-	1,00
HB 56 T4 (A2:6) (40º)	1,10	39,29	45,24	8.480,79	189,26	1,15	-	1,00
HB 56 T4 (A2:6) (42,5º)	1,50	35,79	41,42	9.378,45	175,73	1,29	-	1,00
HB 56 T4 (A2:6) (45º)	1,50	33,90	39,39	9.821,66	168,93	1,36	-	1,00
HB 56 T4 (A2:9) (20º)	0,55	43,18	51,09	4.510,05	188,20	0,56	-	1,00
HB 56 T4 (A2:9) (25º)	0,75	44,95	52,07	5.727,70	206,64	0,75	-	1,00
HB 56 T4 (A2:9) (27,5º)	0,75	44,41	51,28	6.096,34	211,34	0,82	-	1,00
HB 56 T4 (A2:9) (30º)	1,10	44,08	50,45	6.957,51	222,61	0,99	-	1,00
HB 56 T4 (A2:9) (32,5º)	1,10	42,64	48,70	7.427,79	228,49	1,11	-	1,00
HB 56 T4 (A2:9) (35º)	1,10	41,32	47,08	7.870,82	234,75	1,23	-	1,00
HB 56 T4 (A2:9) (37,5º)	1,50	41,13	46,64	8.527,29	232,60	1,35	-	1,00
HB 56 T4 (A2:9) (40º)	1,50	39,82	45,06	9.032,45	234,01	1,49	-	1,00
HB 56 T4 (A2:9) (42,5º)	1,50	38,18	43,05	9.753,80	237,69	1,71	-	1,00
HB 56 T4 (A2:9) (45º)	2,20	39,10	43,90	10.151,47	238,50	1,75	-	1,00
HB 56 T4 (A5:6) (20º)	0,37	45,22	53,82	4.495,62	156,81	0,44	-	1,00
HB 56 T4 (A5:6) (25º)	0,55	49,01	57,11	5.837,90	157,13	0,52	-	1,00
HB 56 T4 (A5:6) (30º)	0,55	49,99	57,60	6.824,50	161,71	0,63	-	1,00
HB 56 T4 (A5:6) (35º)	0,75	47,66	54,67	7.938,85	170,02	0,78	-	1,00
HB 56 T4 (A5:6) (40º)	1,10	39,26	45,21	9.132,29	181,13	1,15	-	1,00
HB 56 T4 (A5:6) (45º)	1,50	35,23	40,59	9.839,96	185,64	1,43	-	1,00
HB 63 T4 (A2:6) (20º)	0,55	46,54	54,64	5.597,59	156,21	0,53	-	1,00

Model	Motor power (kW)	Maximum efficiency point data						
		Max. efficiency (%)	Efficiency grade (N) (N)	Air Flow (m3/h)	Ps (Pa)	Pabs (kW)	speed (rpm)	Specific ratio
HB 63 T4 (A2:6) (25º)	0,75	47,61	54,69	7.295,27	176,58	0,76	-	1,00
HB 63 T4 (A2:6) (27,5º)	0,75	47,56	54,37	7.744,65	183,98	0,84	-	1,00
HB 63 T4 (A2:6) (30º)	1,10	47,75	54,02	8.772,94	199,68	1,02	-	1,00
HB 63 T4 (A2:6) (32,5º)	1,10	46	51,86	9.516,33	206,89	1,19	-	1,00
HB 63 T4 (A2:6) (35º)	1,50	44,72	50,21	10.251,35	213,86	1,36	-	1,00
HB 63 T4 (A2:6) (37,5º)	1,50	42,98	48,16	10.889,88	217,69	1,52	-	1,00
HB 63 T4 (A2:6) (40º)	1,50	40,99	45,84	11.637,19	219,76	1,72	-	1,00
HB 63 T4 (A2:6) (42,5º)	2,20	42,28	47,02	13.042,69	205,81	1,78	-	1,00
HB 63 T4 (A2:6) (45º)	2,20	41,53	46,18	13.663,22	200,21	1,85	-	1,00
HB 63 T4 (A2:9) (20º)	0,75	47,17	54,13	6.148,87	213,88	0,79	-	1,00
HB 63 T4 (A2:9) (25º)	1,10	48,94	55,07	7.962,04	233,30	1,07	-	1,00
HB 63 T4 (A2:9) (27,5º)	1,10	48,40	54,24	8.505,02	241,06	1,20	-	1,00
HB 63 T4 (A2:9) (30º)	1,50	47,84	53,07	9.754,93	258,40	1,49	-	1,00
HB 63 T4 (A2:9) (32,5º)	2,20	47,54	52,45	10.591,50	268,69	1,68	-	1,00
HB 63 T4 (A2:9) (35º)	2,20	45,49	50,02	11.259,62	280,23	1,93	-	1,00
HB 63 T4 (A2:9) (37,5º)	2,20	44,35	48,60	12.083,39	281,74	2,14	-	1,00
HB 63 T4 (A2:9) (40º)	2,20	43,30	47,27	12.859,31	284,14	2,36	-	1,00
HB 63 T4 (A2:9) (42,5º)	3	42,13	45,84	14.284,18	273,90	2,61	-	1,00
HB 63 T4 (A2:9) (45º)	3	41,37	44,93	14.927,31	270,56	2,74	-	1,00
HB 63 T4 (A5:6) (20º)	0,55	58,44	66,30	6.389,10	183,64	0,57	-	1,00
HB 63 T4 (A5:6) (25º)	0,75	57	64,09	7.776,55	192,57	0,76	-	1,00
HB 63 T4 (A5:6) (30º)	1,10	50,05	55,85	9.522,02	226,10	1,22	-	1,00
HB 63 T4 (A5:6) (35º)	1,50	46,36	51,58	10.712,41	232,53	1,50	-	1,00
HB 63 T4 (A5:6) (40º)	2,20	43,08	47,68	12.458,07	235,51	1,88	-	1,00
HB 63 T4 (A5:6) (45º)	2,20	38,10	42,19	13.997,47	219,16	2,26	-	1,00
HB 71 T4 (A2:6) (20º)	0,75	50,01	57,20	7.232,09	180,97	0,73	-	1,00
HB 71 T4 (A2:6) (25º)	1,10	51,02	57,10	9.713,86	205,13	1,09	-	1,00
HB 71 T4 (A2:6) (27,5º)	1,10	50,62	56,39	10.445,36	212,23	1,23	-	1,00
HB 71 T4 (A2:6) (30º)	1,50	49,55	54,68	12.220,43	224,43	1,55	-	1,00
HB 71 T4 (A2:6) (32,5º)	2,20	49,93	54,74	13.295,01	234,64	1,74	-	1,00
HB 71 T4 (A2:6) (35º)	2,20	48,30	52,71	14.300,74	245,13	2,01	-	1,00
HB 71 T4 (A2:6) (37,5º)	2,20	46,71	50,85	15.321,60	243,73	2,22	-	1,00
HB 71 T4 (A2:6) (40º)	2,20	44,72	48,55	16.418,70	242,62	2,49	-	1,00
HB 71 T4 (A2:6) (42,5º)	3	42,46	45,98	18.344,18	230,23	2,79	-	1,00
HB 71 T4 (A2:6) (45º)	3	41,05	44,42	19.243,09	224,55	2,95	-	1,00
HB 71 T4 (A2:9) (20º)	1,10	50,72	56,91	7.655,80	248,42	1,05	-	1,00
HB 71 T4 (A2:9) (25º)	1,50	52,10	57,31	10.640,51	257,93	1,51	-	1,00
HB 71 T4 (A2:9) (27,5º)	1,50	51,40	56,31	11.378,55	267,44	1,68	-	1,00

Model	Motor power (kW)	Maximum efficiency point data						
		Max. efficiency (%)	Efficiency grade (N) (N)	Air Flow (m3/h)	Ps (Pa)	Pabs (kW)	speed (rpm)	Specific ratio
HB 71 T4 (A2:9) (30°)	2,20	51,57	55,93	13.009,18	289,31	2,05	-	1,00
HB 71 T4 (A2:9) (32,5°)	2,20	49,79	53,74	14.180,50	297,36	2,38	-	1,00
HB 71 T4 (A2:9) (35°)	3	48,37	51,95	15.396,63	304,31	2,73	-	1,00
HB 71 T4 (A2:9) (37,5°)	3	46,73	49,99	16.573,97	309,50	3,07	-	1,00
HB 71 T4 (A2:9) (40°)	4	45,40	48,37	17.946,26	309,93	3,41	-	1,00
HB 71 T4 (A2:9) (42,5°)	4	43,23	45,91	18.398,10	316,72	3,78	-	1,00
HB 71 T4 (A2:9) (45°)	4	42,42	44,94	20.056,09	303,54	4,02	-	1,00
HB 71 T4 (A5:6) (20°)	0,75	57,58	64,41	8.372,56	199,99	0,83	-	1,00
HB 71 T4 (A5:6) (25°)	1,10	51,46	57,12	10.421,74	221,18	1,28	-	1,00
HB 71 T4 (A5:6) (30°)	1,50	50,13	54,98	12.513,58	242,11	1,72	-	1,00
HB 71 T4 (A5:6) (35°)	2,20	46,20	50,22	14.810,97	258,66	2,33	-	1,00
HB 71 T4 (A5:6) (40°)	3	42,78	46,35	16.494,79	256,36	2,74	-	1,00
HB 71 T4 (A5:6) (45°)	3	37,02	40,02	18.533,17	241,52	3,37	-	1,00
HB 80 T4 (A2:6) (20°)	1,10	53,21	59,63	9.017,50	205,42	0,97	-	1,00
HB 80 T4 (A2:6) (25°)	1,50	53,14	58,35	12.875,65	221,82	1,50	-	1,00
HB 80 T4 (A2:6) (27,5°)	1,50	52,90	57,79	13.912,06	229,68	1,69	-	1,00
HB 80 T4 (A2:6) (30°)	2,20	53,35	57,60	16.277,48	250,03	2,14	-	1,00
HB 80 T4 (A2:6) (32,5°)	3	52,01	55,85	17.909,79	258,43	2,49	-	1,00
HB 80 T4 (A2:6) (35°)	3	50,95	54,40	19.545,96	267,44	2,86	-	1,00
HB 80 T4 (A2:6) (37,5°)	3	48,19	51,27	20.944,62	272,86	3,29	-	1,00
HB 80 T4 (A2:6) (40°)	4	45,96	48,69	22.257,02	278,20	3,71	-	1,00
HB 80 T4 (A2:6) (42,5°)	4	42,32	44,58	24.366,89	272,71	4,42	-	1,00
HB 80 T4 (A2:6) (45°)	5,50	40,94	43,02	25.624,11	267,80	4,72	-	1,00
HB 80 T4 (A2:9) (20°)	1,50	52,55	57,83	9.930,44	277,46	1,47	-	1,00
HB 80 T4 (A2:9) (25°)	2,20	53,91	58,11	14.232,06	288,73	2,17	-	1,00
HB 80 T4 (A2:9) (27,5°)	2,20	53,20	57,10	15.356,78	294,47	2,42	-	1,00
HB 80 T4 (A2:9) (30°)	3	52,58	55,90	17.836,16	312,15	3	-	1,00
HB 80 T4 (A2:9) (32,5°)	4	50,15	52,98	19.620,62	325,17	3,59	-	1,00
HB 80 T4 (A2:9) (35°)	4	46,84	49,15	21.510,72	335,77	4,34	-	1,00
HB 80 T4 (A2:9) (37,5°)	5,50	46,12	48,16	22.829,66	347,67	4,79	-	1,00
HB 80 T4 (A2:9) (40°)	5,50	45,16	46,91	24.231,93	358,68	5,33	-	1,00
HB 80 T4 (A2:9) (42,5°)	7,50	43,97	45,39	26.699,82	351,80	6	-	1,00
HB 80 T4 (A2:9) (45°)	7,50	42,84	44,10	27.950,61	347,62	6,38	-	1,00
HB 80 T4 (A5:6) (20°)	1,50	50,60	56,25	9.718,37	239,52	1,28	-	1,00
HB 80 T4 (A5:6) (25°)	1,50	51,79	56,64	12.356,85	255,99	1,72	-	1,00
HB 80 T4 (A5:6) (30°)	3	57,60	61,42	17.261,55	298,01	2,50	-	1,00
HB 80 T4 (A5:6) (35°)	3	50,98	54,06	19.869,77	303,75	3,28	-	1,00
HB 80 T4 (A5:6) (40°)	4	48,60	51,08	22.484,61	317,95	4,08	-	1,00

Model	Motor power (kW)	Maximum efficiency point data						
		Max. efficiency (%)	Efficiency grade (N) (N)	Air Flow (m3/h)	Ps (Pa)	Pabs (kW)	speed (rpm)	Specific ratio
HB 90 T4 (A6:3) (20º)	3	47,86	51,68	17.863,23	241,50	2,50	-	1,00
HB 90 T4 (A6:3) (22º)	3	47,91	51,28	19.477,11	260,37	2,94	-	1,00
HB 90 T4 (A6:3) (24º)	4	47,93	50,91	21.003,49	279,10	3,39	-	1,00
HB 90 T4 (A6:3) (26º)	4	46,77	49,36	22.226,07	297,64	3,92	-	1,00
HB 90 T4 (A6:3) (28º)	5,50	46,03	48,27	23.503,70	315,93	4,45	-	1,00
HB 90 T4 (A6:3) (30º)	5,50	43,90	45,82	25.124,90	318	5,01	-	1,00
HB 90 T4 (A6:3) (32º)	5,50	41,52	43,12	27.168,60	312,11	5,62	-	1,00
HB 90 T4 (A6:3) (34º)	7,50	39,63	40,95	28.904,06	310,41	6,23	-	1,00
HB 90 T4 (A6:6) (20º)	4	50,24	52,64	20.935,53	357,55	4,21	-	1,00
HB 90 T4 (A6:6) (22º)	5,50	50,37	52,34	22.948,85	382,82	4,91	-	1,00
HB 90 T4 (A6:6) (24º)	5,50	49,83	51,39	24.822,91	408,33	5,72	-	1,00
HB 90 T4 (A6:6) (26º)	7,50	49,09	50,27	26.295,39	434,32	6,54	-	1,00
HB 90 T4 (A6:6) (28º)	7,50	47,70	48,49	27.997,79	455,42	7,55	-	1,00
HB 90 T4 (A6:6) (30º)	9,20	46,12	46,58	29.455,68	475,22	8,51	-	1,00
HB 90 T4 (A6:6) (32º)	9,20	44,24	44,39	31.020,14	487,87	9,56	-	1,00
HB 90 T4 (A6:6) (34º)	11	42,88	42,92	32.656,98	500,10	10,55	-	1,00
HB 90 T4 (A6:6) (36º)	11	41,66	41,63	34.544,57	503,44	11,60	-	1,00
HB 90 T4 (A6:6) (38º)	15	41,54	41,45	36.648,69	506,77	12,54	-	1,00
HB 100 T4 (A6:3) (20º)	5,50	52,97	55,80	23.588,59	289,56	3,60	-	1,00
HB 100 T4 (A6:3) (22º)	5,50	53,22	55,59	25.751,94	315,11	4,25	-	1,00
HB 100 T4 (A6:3) (24º)	5,50	52,70	54,63	27.799,11	338,97	4,98	-	1,00
HB 100 T4 (A6:3) (26º)	5,50	51,15	52,68	29.438,30	361,04	5,77	-	1,00
HB 100 T4 (A6:3) (28º)	7,50	50,33	51,51	31.256,32	380,11	6,55	-	1,00
HB 100 T4 (A6:3) (30º)	7,50	47,69	48,53	33.567,09	379,57	7,41	-	1,00
HB 100 T4 (A6:3) (32º)	9,20	45,02	45,55	36.499,40	370,95	8,30	-	1,00
HB 100 T4 (A6:3) (34º)	9,20	41,85	42,05	39.149,37	364,08	9,37	-	1,00
HB 100 T4 (A6:6) (20º)	7,50	53,61	55	27.055,23	423,93	6,07	-	1,00
HB 100 T4 (A6:6) (22º)	7,50	53,69	54,59	30.100,38	455,26	7,25	-	1,00
HB 100 T4 (A6:6) (24º)	9,20	53,59	54,07	32.887,61	485,31	8,45	-	1,00
HB 100 T4 (A6:6) (26º)	9,20	53,08	53,21	35.494,98	509,83	9,62	-	1,00
HB 100 T4 (A6:6) (28º)	11	52,38	52,39	38.029,70	536,50	10,91	-	1,00
HB 100 T4 (A6:6) (30º)	15	50,95	50,87	40.939,63	546,46	12,24	-	1,00
HB 100 T4 (A6:6) (32º)	15	49,27	49,11	43.963,32	553,97	13,69	-	1,00
HB 100 T4 (A6:6) (34º)	15	47,15	46,90	46.811,43	561,60	15,36	-	1,00
HB 100 T4 (A6:6) (36º)	18,50	45,06	44,73	49.461,76	567,01	17,05	-	1,00
HB 100 T4 (A6:6) (38º)	18,50	42,76	42,34	52.080,90	571,48	18,99	-	1,00
HB 100 T4 (A6:6) (40º)	22	41,77	41,28	55.041,76	558,03	20,67	-	1,00
HB 112 T4 (A6:3) (20º)	5,50	51,62	53,62	27.680,89	325,76	4,86	-	1,00

Model	Motor power (kW)	Maximum efficiency point data						
		Max. efficiency (%)	Efficiency grade (N) (N)	Air Flow (m3/h)	Ps (Pa)	Pabs (kW)	speed (rpm)	Specific ratio
HB 112 T4 (A6:3) (22º)	5,50	53,28	54,80	31.399,79	353,63	5,79	-	1,00
HB 112 T4 (A6:3) (24º)	7,50	54,40	55,49	34.868,01	379,34	6,75	-	1,00
HB 112 T4 (A6:3) (26º)	7,50	52,47	53,11	38.214,74	395,84	8	-	1,00
HB 112 T4 (A6:3) (28º)	9,20	51,01	51,23	41.811,24	410,47	9,32	-	1,00
HB 112 T4 (A6:3) (30º)	11	49,11	49,16	44.804,52	416,14	10,49	-	1,00
HB 112 T4 (A6:3) (32º)	11	46,70	46,65	47.862,69	420,41	11,87	-	1,00
HB 112 T4 (A6:3) (34º)	15	44,24	44,11	50.935,27	420,05	13,29	-	1,00
HB 112 T4 (A6:3) (36º)	15	41,15	40,92	53.371,22	418,21	14,91	-	1,00
HB 112 T4 (A6:6) (20º)	9,20	52,45	52,88	32.237,17	498,40	8,60	-	1,00
HB 112 T4 (A6:6) (22º)	11	53,91	53,98	36.703,43	526	10,12	-	1,00
HB 112 T4 (A6:6) (24º)	11	54,22	54,16	40.952,51	556,80	11,89	-	1,00
HB 112 T4 (A6:6) (26º)	15	54,94	54,79	45.443,76	576,54	13,48	-	1,00
HB 112 T4 (A6:6) (28º)	15	54,87	54,62	50.032,67	596,99	15,41	-	1,00
HB 112 T4 (A6:6) (30º)	18,50	54,09	53,74	53.668,11	624,79	17,37	-	1,00
HB 112 T4 (A6:6) (32º)	18,50	52,90	52,46	57.359,42	651,53	19,59	-	1,00
HB 112 T4 (A6:6) (34º)	22	51,41	50,88	60.844,52	672,29	21,86	-	1,00
HB 112 T4 (A6:6) (36º)	30	49,32	48,72	64.237,08	680,21	24,21	-	1,00
HB 112 T4 (A6:6) (38º)	30	47,05	46,37	67.632,83	687,72	26,88	-	1,00
HB 112 T4 (A6:6) (40º)	30	46,14	45,38	72.014,78	673,96	29,65	-	1,00
HB 112 T4 (A6:6) (42º)	37	43,82	42,99	76.396,52	661,82	32,57	-	1,00
HB 125 T4 (A7:4) (20º)	9,20	48,86	49,05	37.436,03	441,89	9,42	-	1,00
HB 125 T4 (A7:4) (22º)	11	51,37	51,38	42.358,02	479,07	11	-	1,00
HB 125 T4 (A7:4) (24º)	15	52,90	52,79	47.318,45	512,60	12,76	-	1,00
HB 125 T4 (A7:4) (26º)	15	52,84	52,62	52.423,63	541,11	14,92	-	1,00
HB 125 T4 (A7:4) (28º)	18,50	53,12	52,78	57.577,02	569,69	17,11	-	1,00
HB 125 T4 (A7:4) (30º)	18,50	51,29	50,85	62.077,08	583,99	19,54	-	1,00
HB 125 T4 (A7:4) (32º)	22	49,53	48,99	66.745,10	597,73	22,17	-	1,00
HB 125 T4 (A7:4) (34º)	30	47,27	46,64	71.395,42	601,89	24,93	-	1,00
HB 125 T4 (A7:4) (36º)	30	44,11	43,40	76.332,49	590,34	27,96	-	1,00
HB 125 T4 (A7:8) (20º)	15	50,18	49,93	41.480,11	669,59	15,48	-	1,00
HB 125 T4 (A7:8) (22º)	18,50	51,20	50,81	47.263,50	710,47	18,37	-	1,00
HB 125 T4 (A7:8) (24º)	22	51,84	51,32	53.481,72	747,25	21,65	-	1,00
HB 125 T4 (A7:8) (26º)	30	52,93	52,30	60.188,52	783,77	25,04	-	1,00
HB 125 T4 (A7:8) (28º)	30	53,56	52,81	66.751,27	824,34	28,90	-	1,00
HB 125 T4 (A7:8) (30º)	37	52,70	51,87	72.110,16	851,08	32,59	-	1,00
HB 125 T4 (A7:8) (32º)	37	51,74	50,81	77.824,27	872,54	36,69	-	1,00
HB 125 T4 (A7:8) (34º)	45	50,39	49,37	83.252,88	893,83	41,06	-	1,00
HB 125 T4 (A7:8) (36º)	45	48,97	47,86	89.032,07	905,02	45,80	-	1,00

Model	Motor power (kW)	Maximum efficiency point data						
		Max. efficiency (%)	Efficiency grade (N) (N)	Air Flow (m3/h)	Ps (Pa)	Pabs (kW)	speed (rpm)	Specific ratio
HB 125 T4 (A7:8) (38º)	45	46,85	45,66	94.456,41	922,18	51,51	-	1,00
HB 125 T4 (A7:8) (40º)	45	44,93	43,67	99.748,76	914	56,52	-	1,00
HB 125 T4 (A7:8) (42º)	45	42,73	41,39	103.709,46	915,51	61,86	-	1,00

ERP / 6 poles

Model	Motor power (kW)	Maximum efficiency point data						
		Max. efficiency (%)	Efficiency grade (N) (N)	Air Flow (m3/h)	Ps (Pa)	Pabs (kW)	speed (rpm)	Specific ratio
HB 50 T6 (A0:6) (35º)	0,12	29,57	41,28	2.867,25	51,97	0,14	-	1,00
HB 50 T6 (A0:6) (40º)	0,12	29,94	41,22	3.338,73	52,70	0,16	-	1,00
HB 56 T6 (A2:6) (20º)	0,12	30,59	41,95	2.771,99	63,19	0,16	-	1,00
HB 56 T6 (A2:6) (25º)	0,18	33,64	44,32	3.510,42	69,95	0,20	-	1,00
HB 56 T6 (A2:6) (27,5º)	0,18	33,58	44,05	3.672,17	72,19	0,22	-	1,00
HB 56 T6 (A2:6) (30º)	0,18	33,07	43,05	4.094,24	76,36	0,26	-	1,00
HB 56 T6 (A2:6) (32,5º)	0,25	34,17	43,98	4.410,09	78,51	0,28	-	1,00
HB 56 T6 (A2:6) (35º)	0,25	33,16	42,64	4.753,82	79,97	0,32	-	1,00
HB 56 T6 (A2:6) (37,5º)	0,25	32,61	41,83	5.109,35	79,65	0,35	-	1,00
HB 56 T6 (A2:6) (40º)	0,37	32,38	41,38	5.477,76	79,60	0,38	-	1,00
HB 56 T6 (A2:6) (42,5º)	0,37	29,79	38,49	6.063,41	73,94	0,42	-	1,00
HB 56 T6 (A2:6) (45º)	0,37	28,45	37,02	6.336,33	71,31	0,44	-	1,00
HB 56 T6 (A2:9) (20º)	0,18	32,36	43,06	2.917,65	79,10	0,20	-	1,00
HB 56 T6 (A2:9) (25º)	0,18	34,39	44,35	3.702,61	86,91	0,27	-	1,00
HB 56 T6 (A2:9) (27,5º)	0,25	36,31	46,20	3.951,84	88,63	0,27	-	1,00
HB 56 T6 (A2:9) (30º)	0,25	35,75	45,12	4.510,27	93,49	0,33	-	1,00
HB 56 T6 (A2:9) (32,5º)	0,37	34,99	44,07	4.818,14	96,05	0,37	-	1,00
HB 56 T6 (A2:9) (35º)	0,37	34,45	43,28	5.132,65	97,84	0,40	-	1,00
HB 56 T6 (A2:9) (37,5º)	0,37	34,47	43,06	5.486,25	98,22	0,44	-	1,00
HB 56 T6 (A2:9) (40º)	0,37	33,80	42,16	5.891,27	97,63	0,48	-	1,00
HB 56 T6 (A2:9) (42,5º)	0,55	33,44	41,50	6.312,41	100,05	0,53	-	1,00
HB 56 T6 (A2:9) (45º)	0,55	33,24	41,16	6.581,44	100,16	0,56	-	1,00
HB 56 T6 (A5:6) (20º)	0,18	33,88	45,04	2.997,08	69,69	0,17	-	1,00
HB 56 T6 (A5:6) (25º)	0,18	37,02	47,69	3.891,87	69,84	0,21	-	1,00
HB 56 T6 (A5:6) (30º)	0,18	38,62	48,87	4.549,65	71,87	0,24	-	1,00
HB 56 T6 (A5:6) (35º)	0,25	39,16	48,97	5.292,56	75,56	0,28	-	1,00
HB 56 T6 (A5:6) (40º)	0,37	32,85	41,65	6.088,13	80,50	0,41	-	1,00
HB 56 T6 (A5:6) (45º)	0,37	30,05	38,30	6.605,52	82,14	0,50	-	1,00

Model	Motor power (kW)	Maximum efficiency point data						
		Max. efficiency (%)	Efficiency grade (N) (N)	Air Flow (m3/h)	Ps (Pa)	Pabs (kW)	speed (rpm)	Specific ratio
HB 63 T6 (A2:6) (20º)	0,37	33,20	43,94	3.629,47	65,51	0,20	-	1,00
HB 63 T6 (A2:6) (25º)	0,37	36,82	46,77	4.713,19	74,55	0,27	-	1,00
HB 63 T6 (A2:6) (27,5º)	0,37	37,51	47,25	5.012,22	77,23	0,29	-	1,00
HB 63 T6 (A2:6) (30º)	0,37	38,56	47,81	5.691,23	83,66	0,34	-	1,00
HB 63 T6 (A2:6) (32,5º)	0,37	38,10	47,01	6.161,12	86,82	0,39	-	1,00
HB 63 T6 (A2:6) (35º)	0,37	37,41	45,99	6.649,29	89,61	0,44	-	1,00
HB 63 T6 (A2:6) (37,5º)	0,37	36,52	44,82	7.082,78	91,09	0,49	-	1,00
HB 63 T6 (A2:6) (40º)	0,55	36,28	44,33	7.515,99	92,50	0,53	-	1,00
HB 63 T6 (A2:6) (42,5º)	0,55	36,01	43,88	8.469,61	86,36	0,57	-	1,00
HB 63 T6 (A2:6) (45º)	0,55	35,30	43,08	8.933,54	83,22	0,59	-	1,00
HB 63 T6 (A2:9) (20º)	0,37	36,71	46,56	3.974,97	90,06	0,28	-	1,00
HB 63 T6 (A2:9) (25º)	0,37	39,82	48,97	5.176,19	97,61	0,36	-	1,00
HB 63 T6 (A2:9) (27,5º)	0,37	40,20	49,10	5.520,02	101,08	0,39	-	1,00
HB 63 T6 (A2:9) (30º)	0,37	40,57	48,92	6.329,06	108,71	0,48	-	1,00
HB 63 T6 (A2:9) (32,5º)	0,55	39,96	47,97	6.828,85	112,96	0,54	-	1,00
HB 63 T6 (A2:9) (35º)	0,55	39,10	46,77	7.347,39	117,12	0,61	-	1,00
HB 63 T6 (A2:9) (37,5º)	0,55	38,34	45,76	7.815,16	118,58	0,67	-	1,00
HB 63 T6 (A2:9) (40º)	0,75	38,87	46,11	8.319,23	119,52	0,72	-	1,00
HB 63 T6 (A2:9) (42,5º)	0,75	37,80	44,76	9.247,46	115,29	0,79	-	1,00
HB 63 T6 (A2:9) (45º)	0,75	37,18	44,01	9.652,81	114,15	0,83	-	1,00
HB 63 T6 (A5:6) (20º)	0,37	43,66	54,06	4.259,40	81,62	0,23	-	1,00
HB 63 T6 (A5:6) (25º)	0,37	44,74	54,51	5.182,49	85,62	0,29	-	1,00
HB 63 T6 (A5:6) (30º)	0,37	42,19	50,85	6.348,01	100,49	0,43	-	1,00
HB 63 T6 (A5:6) (35º)	0,55	40,11	48,27	7.141,60	103,35	0,51	-	1,00
HB 63 T6 (A5:6) (40º)	0,55	37,14	44,66	8.305,28	104,67	0,65	-	1,00
HB 63 T6 (A5:6) (45º)	0,75	34,12	41,24	9.329,94	97,42	0,75	-	1,00
HB 71 T6 (A2:6) (20º)	0,37	38,28	48,31	4.675,80	76,12	0,26	-	1,00
HB 71 T6 (A2:6) (25º)	0,37	41,86	50,96	6.302,12	86,22	0,36	-	1,00
HB 71 T6 (A2:6) (27,5º)	0,37	42,18	51,03	6.825,43	88,07	0,40	-	1,00
HB 71 T6 (A2:6) (30º)	0,37	42,25	50,50	7.907,34	94,60	0,50	-	1,00
HB 71 T6 (A2:6) (32,5º)	0,55	42,27	50,20	8.581,39	98,81	0,56	-	1,00
HB 71 T6 (A2:6) (35º)	0,55	41,80	49,37	9.218,05	103,99	0,64	-	1,00
HB 71 T6 (A2:6) (37,5º)	0,55	40,83	48,16	9.982,19	101,58	0,69	-	1,00
HB 71 T6 (A2:6) (40º)	0,75	40,25	47,37	10.642,65	101,62	0,75	-	1,00
HB 71 T6 (A2:6) (42,5º)	0,75	37,86	44,64	11.879,86	96,12	0,85	-	1,00
HB 71 T6 (A2:6) (45º)	0,75	36,79	43,42	12.385,29	94,66	0,90	-	1,00
HB 71 T6 (A2:9) (20º)	0,37	41,10	50,29	4.945,90	104,43	0,35	-	1,00
HB 71 T6 (A2:9) (25º)	0,37	44,09	52,42	6.881,58	108,73	0,48	-	1,00

Model	Maximum efficiency point data							
	Motor power (kW)	Max. efficiency (%)	Efficiency grade (N) (N)	Air Flow (m3/h)	Ps (Pa)	Pabs (kW)	speed (rpm)	Specific ratio
HB 71 T6 (A2:9) (27,5º)	0,55	44,56	52,65	7.358,35	112,21	0,53	-	1,00
HB 71 T6 (A2:9) (30º)	0,55	44,36	51,88	8.445,90	120,61	0,65	-	1,00
HB 71 T6 (A2:9) (32,5º)	0,75	44,56	51,78	9.214,12	124,07	0,72	-	1,00
HB 71 T6 (A2:9) (35º)	0,75	43,34	50,18	9.993,72	127,42	0,83	-	1,00
HB 71 T6 (A2:9) (37,5º)	0,75	41,82	48,34	10.718,70	130,12	0,93	-	1,00
HB 71 T6 (A2:9) (40º)	1,10	41,50	47,79	11.635,72	130,18	1,01	-	1,00
HB 71 T6 (A2:9) (42,5º)	1,10	39,68	45,67	12.454,44	129,23	1,13	-	1,00
HB 71 T6 (A2:9) (45º)	1,10	38,82	44,67	13.031,81	127	1,19	-	1,00
HB 71 T6 (A5:6) (20º)	0,37	46,14	55,71	5.581,71	88,88	0,31	-	1,00
HB 71 T6 (A5:6) (25º)	0,37	43,71	52,26	6.947,87	98,30	0,44	-	1,00
HB 71 T6 (A5:6) (30º)	0,55	44,18	52,02	8.342,39	107,60	0,58	-	1,00
HB 71 T6 (A5:6) (35º)	0,75	41,45	48,50	9.873,98	114,96	0,77	-	1,00
HB 71 T6 (A5:6) (40º)	0,75	38,28	44,88	10.996,52	113,94	0,91	-	1,00
HB 71 T6 (A5:6) (45º)	1,10	34,26	40,38	12.355,45	107,34	1,08	-	1,00
HB 80 T6 (A2:6) (20º)	0,75	43,87	53,32	5.869,64	85,92	0,32	-	1,00
HB 80 T6 (A2:6) (25º)	0,75	46,73	55,17	8.428,22	91,78	0,46	-	1,00
HB 80 T6 (A2:6) (27,5º)	0,75	47,37	55,53	9.025,78	96,48	0,51	-	1,00
HB 80 T6 (A2:6) (30º)	0,75	47,17	54,66	10.572,62	104,25	0,65	-	1,00
HB 80 T6 (A2:6) (32,5º)	0,75	46,74	53,84	11.676,45	108,10	0,76	-	1,00
HB 80 T6 (A2:6) (35º)	0,75	45,66	52,37	12.709,28	111,98	0,87	-	1,00
HB 80 T6 (A2:6) (37,5º)	1,10	44,39	50,81	13.500,43	115	0,97	-	1,00
HB 80 T6 (A2:6) (40º)	1,10	42,01	48,08	14.381,77	116,95	1,10	-	1,00
HB 80 T6 (A2:6) (42,5º)	1,10	38,80	44,38	15.773,02	114,58	1,31	-	1,00
HB 80 T6 (A2:6) (45º)	1,50	37,84	43,27	16.674,15	111,89	1,39	-	1,00
HB 80 T6 (A2:9) (20º)	0,75	46,31	54,80	6.435,84	116,89	0,46	-	1,00
HB 80 T6 (A2:9) (25º)	0,75	47,84	55,29	9.202,40	121,51	0,66	-	1,00
HB 80 T6 (A2:9) (27,5º)	0,75	47,57	54,75	9.873,19	124,39	0,73	-	1,00
HB 80 T6 (A2:9) (30º)	0,75	47,20	53,79	11.569,36	131,24	0,91	-	1,00
HB 80 T6 (A2:9) (32,5º)	1,10	45,84	51,99	12.707,55	136,89	1,07	-	1,00
HB 80 T6 (A2:9) (35º)	1,10	42,87	48,51	13.882,14	141,44	1,29	-	1,00
HB 80 T6 (A2:9) (37,5º)	1,50	42,94	48,33	14.868,76	145,92	1,41	-	1,00
HB 80 T6 (A2:9) (40º)	1,50	41,74	46,84	15.689,22	150,60	1,57	-	1,00
HB 80 T6 (A2:9) (42,5º)	2,20	40,76	45,55	17.313,51	147,18	1,76	-	1,00
HB 80 T6 (A2:9) (45º)	2,20	39,71	44,33	18.133,18	145,20	1,86	-	1,00
HB 80 T6 (A5:6) (20º)	0,75	44,10	52,71	6.478,97	106,45	0,44	-	1,00
HB 80 T6 (A5:6) (25º)	0,75	46,78	54,69	8.237,88	113,78	0,56	-	1,00
HB 80 T6 (A5:6) (30º)	0,75	51,64	58,49	11.507,70	132,45	0,83	-	1,00
HB 80 T6 (A5:6) (35º)	1,10	47,12	53,31	13.246,54	135	1,05	-	1,00

Model	Motor power (kW)	Maximum efficiency point data						
		Max. efficiency (%)	Efficiency grade (N) (N)	Air Flow (m3/h)	Ps (Pa)	Pabs (kW)	speed (rpm)	Specific ratio
HB 80 T6 (A5:6) (40º)	1,10	44,42	49,99	14.989,74	141,31	1,32	-	1,00
HB 80 T6 (A5:6) (45º)	1,50	38,67	43,70	17.074,55	130,65	1,61	-	1,00
HB 90 T6 (A6:3) (20º)	0,75	42,93	50,01	11.655,62	100,63	0,76	-	1,00
HB 90 T6 (A6:3) (22º)	0,75	42,80	49,44	12.594,45	109,28	0,89	-	1,00
HB 90 T6 (A6:3) (24º)	1,10	43,84	50,15	13.636	117,21	1,01	-	1,00
HB 90 T6 (A6:3) (26º)	1,10	42,79	48,70	14.329,80	125,47	1,16	-	1,00
HB 90 T6 (A6:3) (28º)	1,10	41,84	47,39	15.114,86	133,70	1,33	-	1,00
HB 90 T6 (A6:3) (30º)	1,50	40,66	45,93	16.331,72	133,18	1,47	-	1,00
HB 90 T6 (A6:3) (32º)	1,50	38,39	43,35	17.530,96	131,64	1,65	-	1,00
HB 90 T6 (A6:3) (34º)	2,20	36,96	41,65	18.745,80	130,07	1,82	-	1,00
HB 90 T6 (A6:3) (36º)	2,20	34,53	38,90	19.855,62	129,62	2,05	-	1,00
HB 90 T6 (A6:3) (38º)	2,20	32,03	36,07	21.084,47	127,51	2,31	-	1,00
HB 90 T6 (A6:6) (20º)	1,10	45,95	51,67	13.525,17	151,01	1,25	-	1,00
HB 90 T6 (A6:6) (22º)	1,50	46,77	52,10	14.868,56	161,48	1,44	-	1,00
HB 90 T6 (A6:6) (24º)	1,50	46,22	51,13	16.093,63	171,86	1,68	-	1,00
HB 90 T6 (A6:6) (26º)	2,20	45,82	50,38	17.106,27	181,43	1,91	-	1,00
HB 90 T6 (A6:6) (28º)	2,20	44,51	48,69	18.062,80	192,50	2,19	-	1,00
HB 90 T6 (A6:6) (30º)	2,20	43,01	46,85	19.133,80	199,01	2,48	-	1,00
HB 90 T6 (A6:6) (32º)	3	41,87	45,43	20.023,73	206,31	2,75	-	1,00
HB 90 T6 (A6:6) (34º)	3	40,22	43,49	21.166,24	209,08	3,05	-	1,00
HB 90 T6 (A6:6) (36º)	3	39,29	42,30	22.377,36	211,71	3,36	-	1,00
HB 90 T6 (A6:6) (38º)	4	39,34	42,15	23.811,79	212,36	3,62	-	1,00
HB 90 T6 (A6:6) (40º)	4	37,28	39,86	25.355,53	205,24	3,94	-	1,00
HB 100 T6 (A6:3) (20º)	1,10	48,66	54,82	15.269,87	121,92	1,07	-	1,00
HB 100 T6 (A6:3) (22º)	1,10	48,55	54,22	16.701,36	132,54	1,27	-	1,00
HB 100 T6 (A6:3) (24º)	1,50	48,84	54,12	17.985,64	142,77	1,46	-	1,00
HB 100 T6 (A6:3) (26º)	1,50	47,23	52,10	19.152,33	150,97	1,70	-	1,00
HB 100 T6 (A6:3) (28º)	2,20	46,96	51,52	20.236,81	159,70	1,91	-	1,00
HB 100 T6 (A6:3) (30º)	2,20	44,55	48,78	21.822,21	158,77	2,15	-	1,00
HB 100 T6 (A6:3) (32º)	2,20	41,76	45,65	23.575,66	155,94	2,43	-	1,00
HB 100 T6 (A6:3) (34º)	3	39,70	43,32	25.358,26	153,43	2,69	-	1,00
HB 100 T6 (A6:3) (36º)	3	36,69	40,02	26.972,39	148,05	3	-	1,00
HB 100 T6 (A6:3) (38º)	3	34,56	37,59	29.161,39	141,13	3,34	-	1,00
HB 100 T6 (A6:6) (20º)	2,20	49,96	54,72	17.486,80	179,25	1,77	-	1,00
HB 100 T6 (A6:6) (22º)	2,20	50,10	54,39	19.498,65	190,85	2,11	-	1,00
HB 100 T6 (A6:6) (24º)	2,20	49,98	53,83	21.348,84	203,68	2,47	-	1,00
HB 100 T6 (A6:6) (26º)	3	50,17	53,72	22.968,11	214,14	2,76	-	1,00
HB 100 T6 (A6:6) (28º)	3	49,07	52,24	24.613,37	225,37	3,16	-	1,00

Model	Motor power (kW)	Maximum efficiency point data						
		Max. efficiency (%)	Efficiency grade (N) (N)	Air Flow (m3/h)	Ps (Pa)	Pabs (kW)	speed (rpm)	Specific ratio
HB 100 T6 (A6:6) (30º)	4	48,03	50,91	26.508	229,19	3,53	-	1,00
HB 100 T6 (A6:6) (32º)	4	46,33	48,89	28.489,87	232,14	3,96	-	1,00
HB 100 T6 (A6:6) (34º)	4	44,41	46,65	30.354,18	235,59	4,44	-	1,00
HB 100 T6 (A6:6) (36º)	5,50	42,72	44,70	32.077,28	237,53	4,89	-	1,00
HB 100 T6 (A6:6) (38º)	5,50	40,60	42,28	33.810,22	240,04	5,45	-	1,00
HB 100 T6 (A6:6) (40º)	5,50	39,49	40,94	35.779	233,18	5,94	-	1,00
HB 100 T6 (A6:6) (42º)	7,50	37,87	39,14	37.513,81	227,81	6,34	-	1,00
HB 112 T6 (A6:3) (20º)	1,50	47,85	53,21	17.858,55	137,35	1,43	-	1,00
HB 112 T6 (A6:3) (22º)	1,50	49,36	54,23	20.267,63	149,43	1,71	-	1,00
HB 112 T6 (A6:3) (24º)	2,20	50,73	55,20	22.635,90	158,75	1,97	-	1,00
HB 112 T6 (A6:3) (26º)	2,20	49,11	53,13	24.842,09	165,68	2,33	-	1,00
HB 112 T6 (A6:3) (28º)	3	48,25	51,88	27.083,62	172,28	2,68	-	1,00
HB 112 T6 (A6:3) (30º)	3	46,21	49,50	29.004,93	175,13	3,04	-	1,00
HB 112 T6 (A6:3) (32º)	3	43,72	46,65	31.060,32	176,18	3,45	-	1,00
HB 112 T6 (A6:3) (34º)	4	41,66	44,31	32.962,45	176,55	3,84	-	1,00
HB 112 T6 (A6:3) (36º)	4	38,64	40,97	34.545,12	175,66	4,32	-	1,00
HB 112 T6 (A6:3) (38º)	5,50	36,34	38,39	36.455,29	173,36	4,78	-	1,00
HB 112 T6 (A6:6) (20º)	2,20	48,67	52,47	20.848	209,34	2,52	-	1,00
HB 112 T6 (A6:6) (22º)	3	50,69	54,07	23.752,54	221,76	2,93	-	1,00
HB 112 T6 (A6:6) (24º)	3	50,81	53,75	26.484,45	234,27	3,45	-	1,00
HB 112 T6 (A6:6) (26º)	4	51,68	54,29	29.506,12	241,29	3,90	-	1,00
HB 112 T6 (A6:6) (28º)	4	51,64	53,87	32.443,65	250,25	4,45	-	1,00
HB 112 T6 (A6:6) (30º)	5,50	51,28	53,21	34.808,90	261,77	4,98	-	1,00
HB 112 T6 (A6:6) (32º)	5,50	50,14	51,74	37.132,25	273,49	5,62	-	1,00
HB 112 T6 (A6:6) (34º)	7,50	49,60	50,95	39.423,52	282,46	6,17	-	1,00
HB 112 T6 (A6:6) (36º)	7,50	47,28	48,33	41.617,76	285,29	6,87	-	1,00
HB 112 T6 (A6:6) (38º)	7,50	45,02	45,78	43.738,41	289,26	7,64	-	1,00
HB 112 T6 (A6:6) (40º)	11	44,42	44,92	46.645,30	283,18	8,38	-	1,00
HB 112 T6 (A6:6) (42º)	11	42,03	42,27	49.498,53	277,92	9,24	-	1,00
HB 125 T6 (A7:4) (20º)	3	46,31	49,91	24.233,19	185,89	2,71	-	1,00
HB 125 T6 (A7:4) (22º)	3	48,21	51,36	27.403,92	201,73	3,19	-	1,00
HB 125 T6 (A7:4) (24º)	4	49,90	52,66	30.566,95	216,22	3,69	-	1,00
HB 125 T6 (A7:4) (26º)	4	49,67	51,99	33.888,81	227,55	4,32	-	1,00
HB 125 T6 (A7:4) (28º)	5,50	50,32	52,28	37.240,81	239,65	4,92	-	1,00
HB 125 T6 (A7:4) (30º)	5,50	48,74	50,35	40.177,12	245,56	5,59	-	1,00
HB 125 T6 (A7:4) (32º)	7,50	47,70	49	43.209,79	251,25	6,26	-	1,00
HB 125 T6 (A7:4) (34º)	7,50	45,32	46,29	46.312,63	252,25	7,07	-	1,00
HB 125 T6 (A7:4) (36º)	7,50	42,35	43	49.665,35	247,58	7,95	-	1,00

Model	Motor power (kW)	Maximum efficiency point data						
		Max. efficiency (%)	Efficiency grade (N) (N)	Air Flow (m ³ /h)	Ps (Pa)	Pabs (kW)	speed (rpm)	Specific ratio
HB 125 T6 (A7:8) (20°)	4	47,06	49,27	26.696,21	283,54	4,49	-	1,00
HB 125 T6 (A7:8) (22°)	5,50	48,56	50,34	30.645,08	297,68	5,26	-	1,00
HB 125 T6 (A7:8) (24°)	7,50	49,95	51,32	34.677,46	313,95	6,11	-	1,00
HB 125 T6 (A7:8) (26°)	7,50	50,74	51,70	38.941,53	329,25	7,10	-	1,00
HB 125 T6 (A7:8) (28°)	7,50	51,29	51,84	43.274,16	346,56	8,23	-	1,00
HB 125 T6 (A7:8) (30°)	11	50,67	50,91	46.803,60	357,08	9,23	-	1,00
HB 125 T6 (A7:8) (32°)	11	49,60	49,65	50.345,14	366,45	10,38	-	1,00
HB 125 T6 (A7:8) (34°)	11	48,50	48,47	54.072,65	373,66	11,61	-	1,00
HB 125 T6 (A7:8) (36°)	15	47,63	47,52	57.707,96	379,39	12,79	-	1,00
HB 125 T6 (A7:8) (38°)	15	45,59	45,39	61.565,16	384,24	14,45	-	1,00
HB 125 T6 (A7:8) (40°)	15	43,46	43,18	64.341,26	384,84	15,88	-	1,00
HB 125 T6 (A7:8) (42°)	15	41,62	41,27	67.617,95	381,61	17,38	-	1,00