



CENTRIFUGAL SMOKE EXTRACTION FANS

SMOKE EXTRACTION PRODUCT CATALOGS



**MEDIUM PRESSURE AXIAL
FANS AND AXIAL SMOKE
EXTRACTION FANS**



**CENTRIFUGAL SMOKE
EXTRACTION FANS**



**SMOKE EXTRACTION VENTILATION
FOR PARKING PREMISES**



FIRE SAFETY DAMPERS



60 Hz



**MEDIUM PRESSURE AXIAL
FANS AND AXIAL SMOKE
EXTRACTION FANS**



60 Hz



**SMOKE EXTRACTION VENTILATION
FOR PARKING PREMISES**



CONTENTS

Smoke extraction systems of buildings	2
Tower-SV-K2. Roof-mounted centrifugal fan for smoke extraction with vertical air discharge	6
BOX-S. Duct smoke extraction fan	12
Accessories for roof-mounted smoke extraction fans	17
Accessories for duct smoke extraction fans	18
Operation of fans with frequency converters	19
Frequency converters	20

SMOKE EXTRACTION SYSTEMS OF BUILDINGS

Smoke control is a complex process involving smoke extraction and fresh air supply by the supply and exhaust ventilation system of buildings in order to ensure safe evacuation of people in case of a fire in any of the spaces.

The smoke control system of a building or structure must ensure protection of people along the evacuation paths from the fire hazards during the time required for the personnel evacuation procedure or the entire period of fire development and control by means of extracting the combustion and thermal decomposition products and/or preventing their spreading. A smoke control system is an integral element of a utility system design including all kinds of high-rise buildings, shopping and office centres, hospital facilities, production and storage spaces etc. as well as underground structures.

According to conclusive evidence the majority of mortalities in a fire are caused by poisoning from carbon monoxide and other combustion products. Carbon monoxide is one of the most toxic smoke components. It is carbon monoxide poisoning that accounts for 80 % of the fire accident causes. Fires in closed spaces where oxygen supply is limited are especially prone to intensive carbon monoxide generation. Carbon monoxide poisoning occurs when its concentration in the inspiratory air exceeds 0.08 %. Concentration growth up to 0.32 % results in paralysis and loss of consciousness (with imminent death in about 30 minutes). Concentrations in excess of 1.2 % lead to loss of consciousness after 2-3 aspirations whereas another 2-3 minutes are fatal. Smoke spreads much faster than fire, therefore causing loss of consciousness and cardiac arrest before the victim reaches the safety outdoors. Furthermore, smoke contamination impacts spatial orientation forcing the victim to negotiate obstacles by touch and, quite often, to diverge from the escape paths.

FIRE IN A BUILDING WITHOUT A SMOKE CONTROL SYSTEM

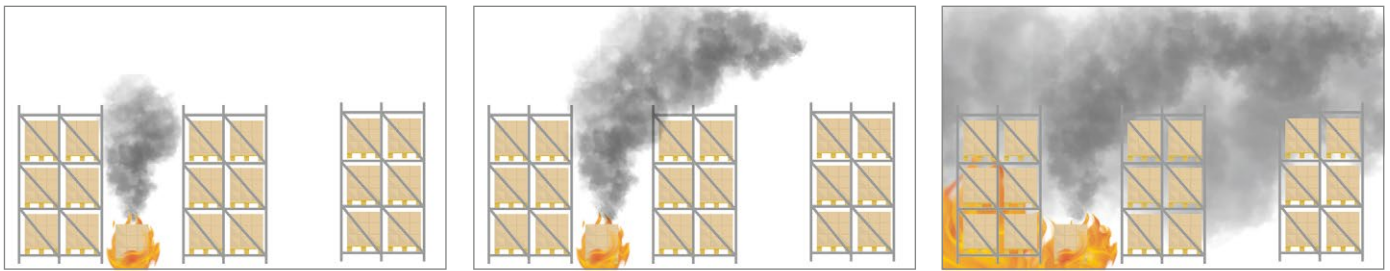

FIRE IN A BUILDING EQUIPPED WITH A SMOKE CONTROL SYSTEM

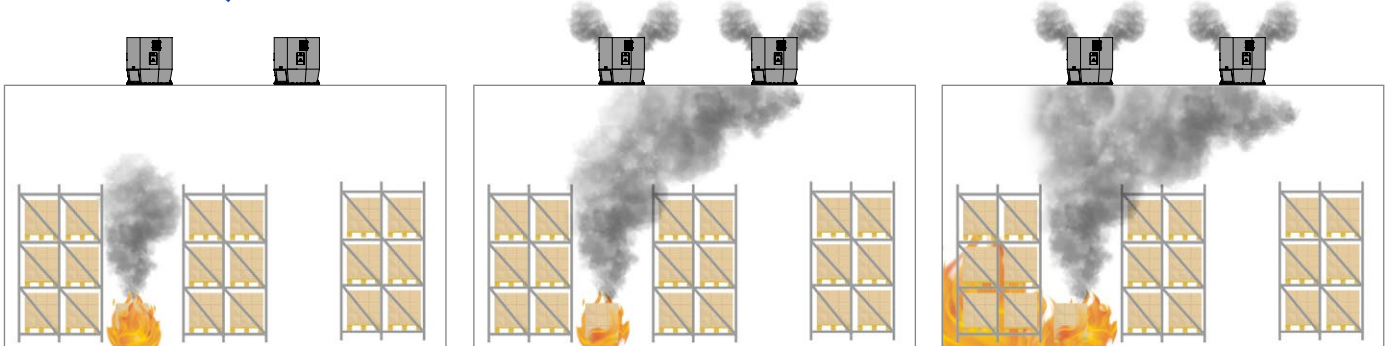

SMOKE CONTROL SYSTEM SOLUTION

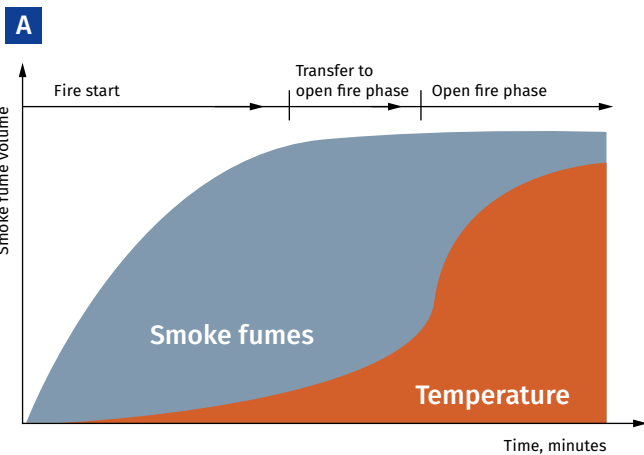

The A chart clearly shows that at the fire origin where no fire control systems are present, the smoke fume volume rapidly becomes critical.

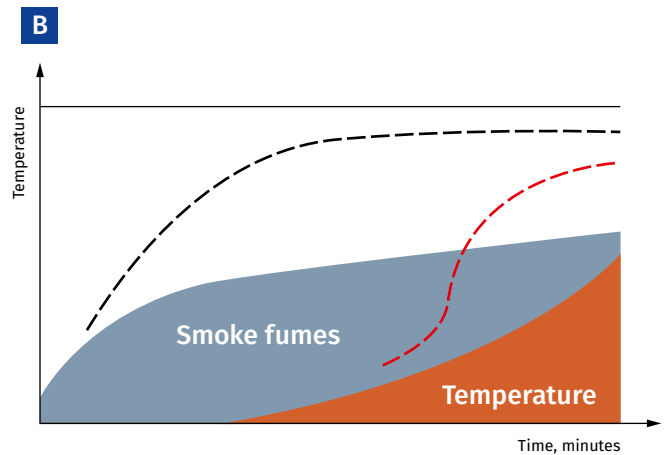

However, the B chart shows that a fire control extraction system helps to significantly reduce the content of smoke in the gas environment which remains below the safety threshold during the entire duration of fire.

SMOKE CONTROL SYSTEM FUNCTIONS:

- o Prevention of smoke spreading from the ignition source.
- o Prevention of smoke transfer to the evacuation paths (maintaining acceptable conditions for the people being evacuated from the building).
- o Maintaining a microclimate beyond the ignition source area to enable normal operation of fire-fighting teams.
- o Protecting life of people in the building.
- o Protecting property against damage.

DESIGN:

- o The smoke control system elements are integrated at the initial phase of the building (residential complex, office block, warehouse facility etc.) construction. These communications must be contained in the design engineering documents specific to the life-support system. All the works specific to the design and installation of smoke control systems are strictly covered by the applicable construction standards and regulations.
- o Smoke control plays a paramount role in making a building safe and ensuring compliance with any and all fire safety standards and regulations. Purpose-built smoke exhaust duct lines provide additional safety and enable easy evacuation of people using corridors and stairs which are completely free of hazardous fumes.
- o Smoke control is a complex process affected by numerous conditions and factors, and, therefore, the design of such communication systems requires an expert qualification. Smoke control systems must only be designed by professionals since any disregard of the commonly accepted state regulations may lead to human casualties.

SMOKE CONTROL SYSTEMS CONSIST OF:

- o **Smoke extraction fans** which are used in emergency exhaust ventilation systems for forced extraction of smoke and heated gases and simultaneous transfer of heat generated by the fire away and beyond the limits of the serviced spaces where the ignition occurs. Such units are used in production, public, residential, administrative and other spaces. Such fans are capable of handling smoke and air mixtures with temperatures up to 600 °C.
- o **Pressurization fans** are intended for creating a positive pressure differential in lift shafts, at landings and in air-lock corridors to prevent their contamination by smoke.
- o **Smoke dampers** installed on the protected premises accept smoke fumes and direct them into smoke shafts. Such devices are equipped with electric magnet or electric actuators. The dampers are rated according to the fire-resistance limit which can vary up to 180 minutes at the smoke temperature of 600 °C.
- o **Fire-resisting dampers** are installed in exhaust ventilation and general ventilation systems to prevent the spread of fire hazards (fire and smoke fumes). Such units are equipped with an electric actuator or a thermal lock.
- o **Ventilation air ducts and shafts** are intended for transferring smoke fumes from the protected premises away from the building. Air ducts are made of non-combustible materials.

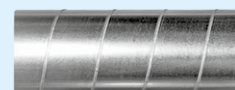
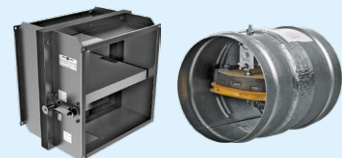
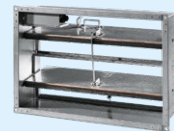
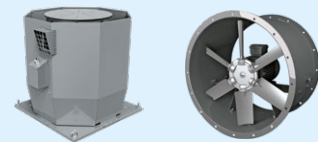

SAMPLE SCHEME AND OPERATION OF A SMOKE EXTRACTION SYSTEM IN A MULTI-STOREY RESIDENTIAL BUILDING WITH AN UNDERGROUND CAR PARK

SMOKE CONTROL SYSTEM SOLUTION

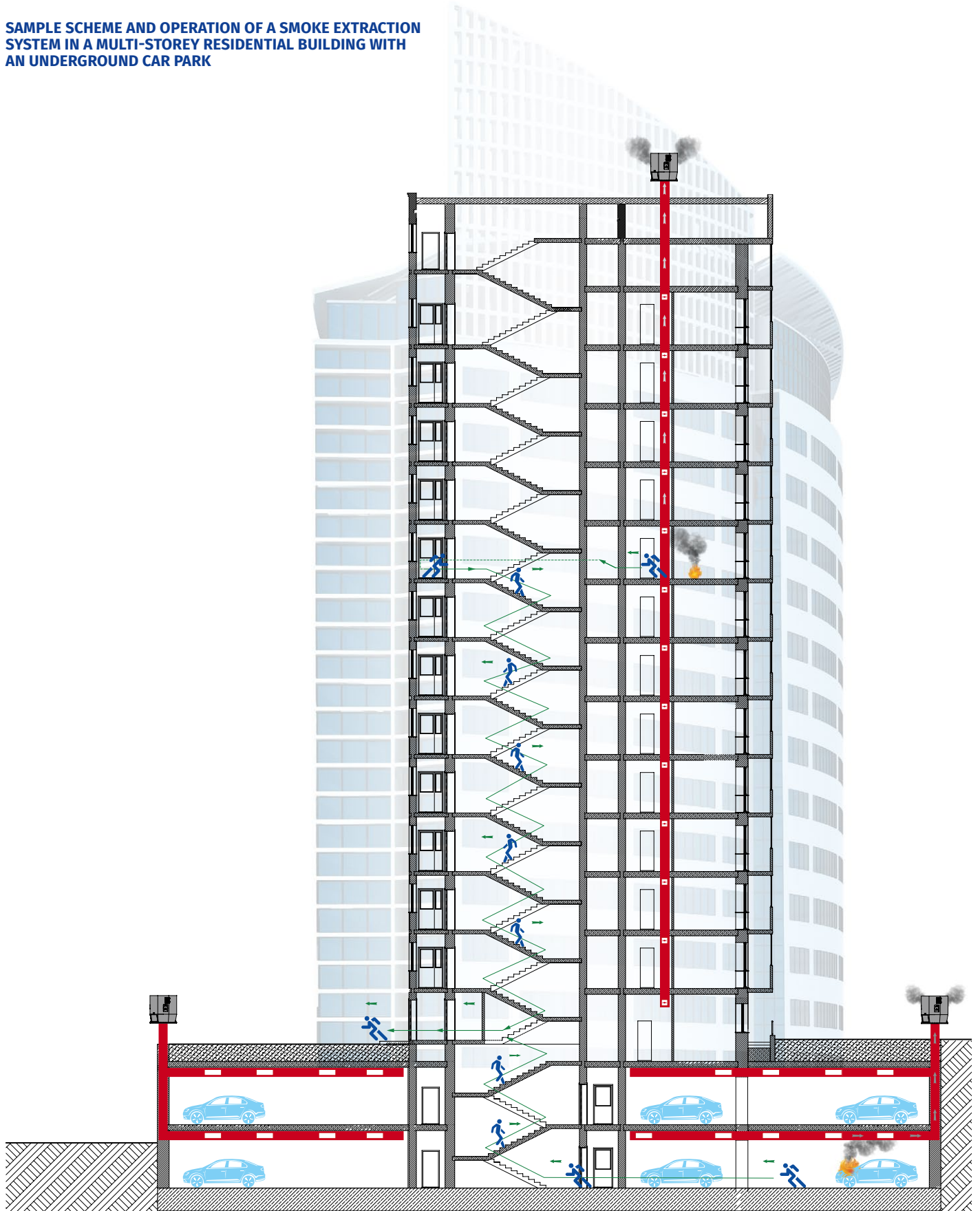

Typical smoke control system solution in case of a fire on the second floor:
Ventilation system: fire-resisting dampers **BSK** ③ and ④ block the floor 2 (closed), thus containing the fire and smoke at the ignition floor, fire-resisting dampers **BSK** ② and ⑥ remain open enabling pressurisation of the adjacent floors 1 and 3 by the supply ventilation system while fire-resisting dampers **BSK** ① and ⑤ in the exhaust ventilation branch remain closed.

Smoke control system: smoke extraction is handled by the **Tower-SH / Tower-SV** fan via the open **RSKM** ⑪ damper, the supply air is fed from the air pressurisation system via the open damper ⑧ while dampers ⑦, ⑨, ⑩ and ⑫ remain closed.

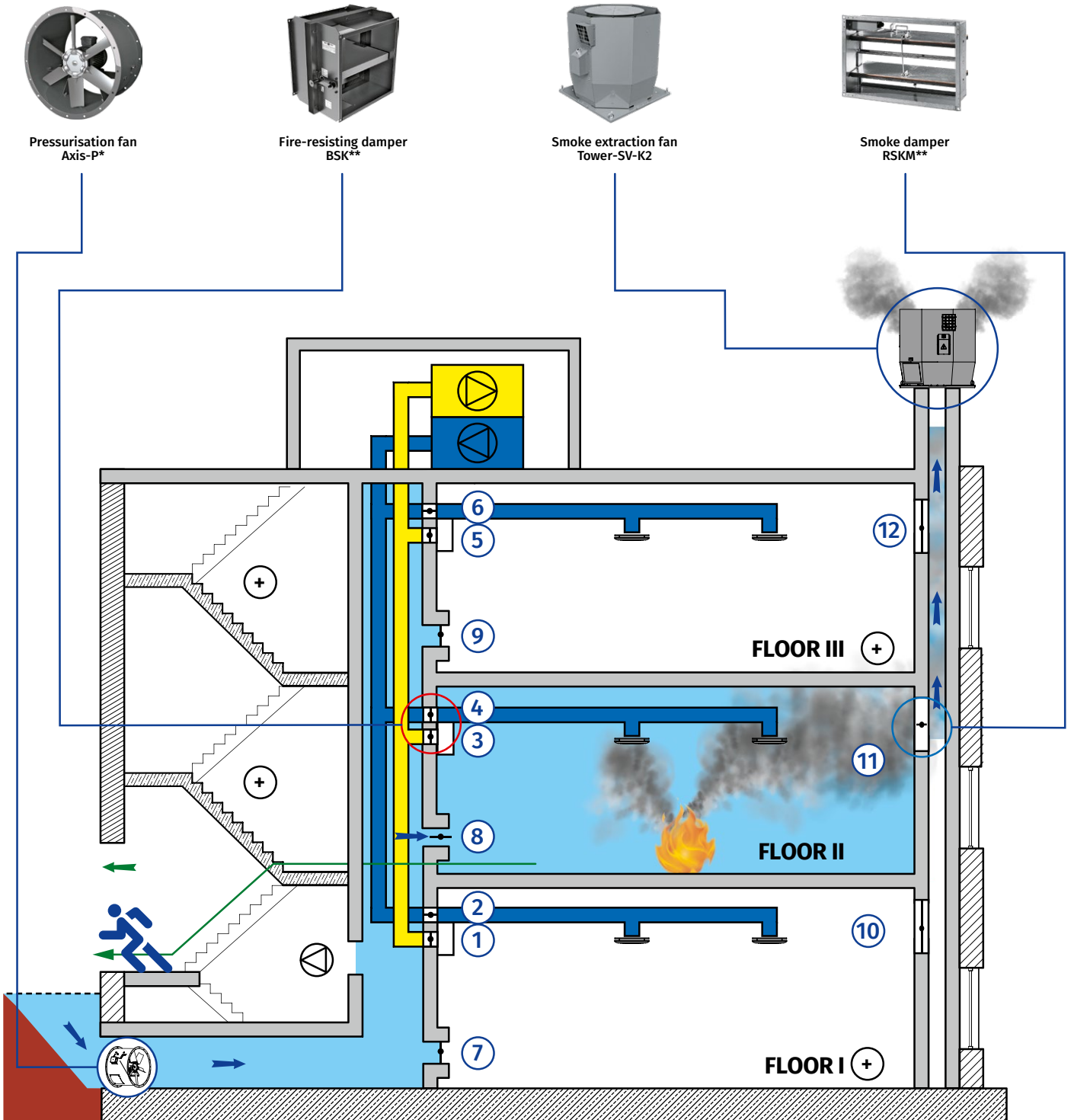

*Detailed information on fans is provided in the "Medium pressure axial fans and axial smoke extraction fans" catalogue.
 **Detailed information on dampers is provided in the "Fire safety dampers" catalogue.

TOWER-SV-K2

Roof-mounted centrifugal fan for smoke extraction with vertical air discharge

Use

- Smoke extraction fans are used in emergency exhaust ventilation systems for forced extraction of smoke and heated gases and simultaneous transfer of heat away and beyond the limits of the serviced spaces in case of fire.
- Such units are used in production, public, residential, administrative and other spaces.



Air flow:
up to 86 500 m³/h



Transported air temperature:
600 °C/2 hours



Operation

- The fans are capable of handling smoke and air mixtures with temperatures up to +600 °C for 120 minutes.
- The fans can operate in conjunction with a frequency converter (hereinafter referred to as FC) or directly when connected to power supply.
- The aerodynamic characteristics of the fans for mains operation are given below.
- The fan can be used for general exhaust ventilation.
- The fan can be designed for moderate (U), tropical (T) or maritime moderately cold (M) climate conditions.

Design

- The fans are made of heat resistant steel with polymer coating providing weathering resistance.
- Equipped with a protective grille against accidental touches and ingress of foreign objects.
- The impeller with backward curved blades are painted with powder coating.
- Can be additionally equipped with a service switch.

Motor

- The fans are equipped with three-phase electric motors rated for 400 V.
- The motor is located in the compartment offset from the transported air stream.
- Motor ingress protection rating is IP54.

Installation

- The fans can be installed directly on the roof or on the SM-AF mounting curb.
- Make sure that the location provides for sufficient space as required for the fan maintenance.



SM-AF mounting curb
Detailed information on the SM-AF mounting curb is given in the section "Accessories for roof-mounted smoke extraction fans".

Designation key

Model	Impeller size [mm]	Number of motor poles	Motor phase and operation modes	Motor power [kW]	Options	Climatic modification	Fire resistance	Frequency, Hz	Paint colour
Tower-SV-K2: roof-mounted centrifugal smoke extraction fan with vertical air discharge in an octagonal casing	315; 355; 400; 450; 500; 560; 630; 710; 800; 900; 1000; 1120	- 2; 4; 6; 8; 10	E: single-phase across-the-line motor EP: single-phase motor with variable frequency start D: three-phase motor DP: three-phase motor with variable frequency start	0.12; 0.25; 0.37; 0.55; 0.75; 1.1; 1.5; 2.2; 3; 4; 5.5; 7.5; 11; 15; 18.5; 22; 30; 37; 45	- K: with a terminal box S1: built-in external switch	- U1: temperate climate HL1: cold climate T1: tropical climate M1: maritime moderately cold climate	- 200/2: 200°C/2 hours; 300/2: 300°C/2 hours; 400/2: 400°C/2 hours; 600/2: 600°C/2 hours	- 50 Hz 60Hz: 60 Hz	- RAL7040 gray by default RALxxxx: paint colour according to RALxxxx Zn: galvanized steel

ROOF-MOUNTED SMOKE EXTRACTION FANS

Overall dimensions [mm]

Model	H	A	B	C	Ø d
Tower-SV-K2 315-2D/1.1-K	779	680	480	820	16
Tower-SV-K2 355-4D/0.25-K	744	680	480	820	16
Tower-SV-K2 355-2D/2.2-K	801	680	480	820	16
Tower-SV-K2 400-6D/0.25-K	772	760	580	866	16
Tower-SV-K2 400-4D/0.55-K	897	760	580	880	16
Tower-SV-K2 450-6D/0.25-K	794	760	580	864	16
Tower-SV-K2 450-4D/1.1-K	929	810	640	933	16
Tower-SV-K2 500-8D/0.25-K	888	830	640	950	16
Tower-SV-K2 500-6D/0.55-K	991	830	640	1094	16
Tower-SV-K2 500-4D/1.5-K	921	1000	750	1082	16
Tower-SV-K2 560-8D/0.37-K	991	1000	750	1094	16
Tower-SV-K2 560-6D/0.75-K	991	1000	750	1094	16
Tower-SV-K2 560-4D/3-K	991	1000	750	1094	16
Tower-SV-K2 630-8D/0.75-K	1060	1010	750	1121	16
Tower-SV-K2 630-6D/1.5-K	1105	1180	980	1257	16
Tower-SV-K2 630-4D/5.5-K	1264	1180	980	1267	16
Tower-SV-K2 710-8D/1.1-K	1237	1180	980	1311	16
Tower-SV-K2 710-6D/2.2-K	1387	1180	980	1311	16
Tower-SV-K2 710-4D/11-K	1297	1180	980	1311	16
Tower-SV-K2 800-8D/2.2-K	1297	1340	1050	1494	16
Tower-SV-K2 800-6D/4-K	1448	1340	1050	1494	16
Tower-SV-K2 800-4D/15-K	1600	1340	1050	1524	16
Tower-SV-K2 900-10D/2.2-K	1595	1550	1340	1686	16
Tower-SV-K2 900-8D/7.5-K	1680	1550	1340	1686	16
Tower-SV-K2 900-6D/15-K	1829	1550	1340	1686	16
Tower-SV-K2 1000-10D/3-K	1753	1640	1340	1876	16
Tower-SV-K2 1000-8D/11-K	1866	1640	1340	1876	16
Tower-SV-K2 1000-6D/22-K	1789	1640	1340	1876	16
Tower-SV-K2 1120-8D/15-K	1956	1640	1340	1876	16
Tower-SV-K2 1120-6D/30-K	1956	1640	1340	1876	16

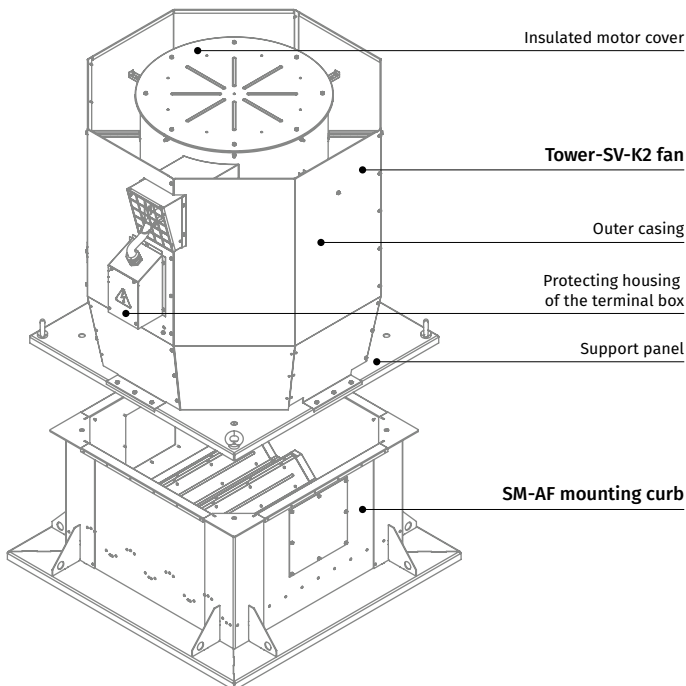
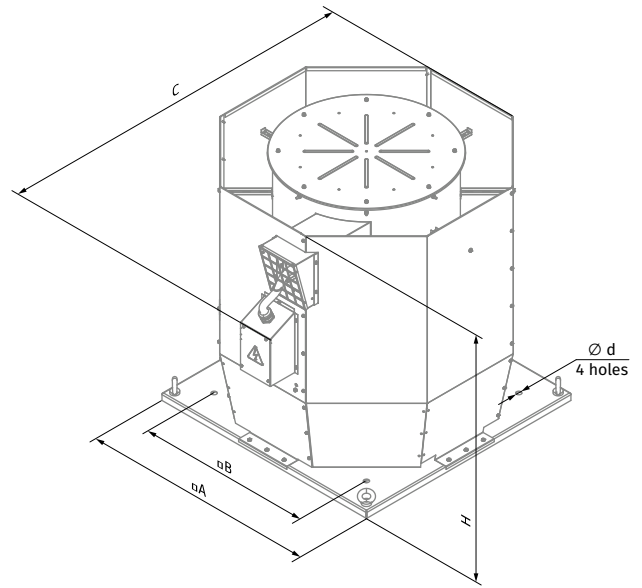

Technical data

Standard size	Number of poles	Voltage [V/50 Hz]	Fan model	Rated power Ny [kW]	RPM [min ⁻¹]	Curve number
315	2	3~400	Tower-SV-K2 315-2D/1.1-K	1.1	2880	①
355	4	3~400	Tower-SV-K2 355-4D/0.25-K	0.25	1335	②
	2	3~400	Tower-SV-K2 355-2D/2.2-K	2.2	2900	③
400	6	3~400	Tower-SV-K2 400-6D/0.25-K	0.25	860	④
	4	3~400	Tower-SV-K2 400-4D/0.55-K	0.55	1345	⑤
	2	3~400	Tower-SV-K2 400-2D/4-K	4	2840	⑥
450	6	3~400	Tower-SV-K2 450-6D/0.25-K	0.25	860	⑦
	4	3~400	Tower-SV-K2 450-4D/1.1-K	1.1	1400	⑧
	2	3~400	Tower-SV-K2 450-2D/7.5-K	7.5	2948	⑨

Standard size: 315

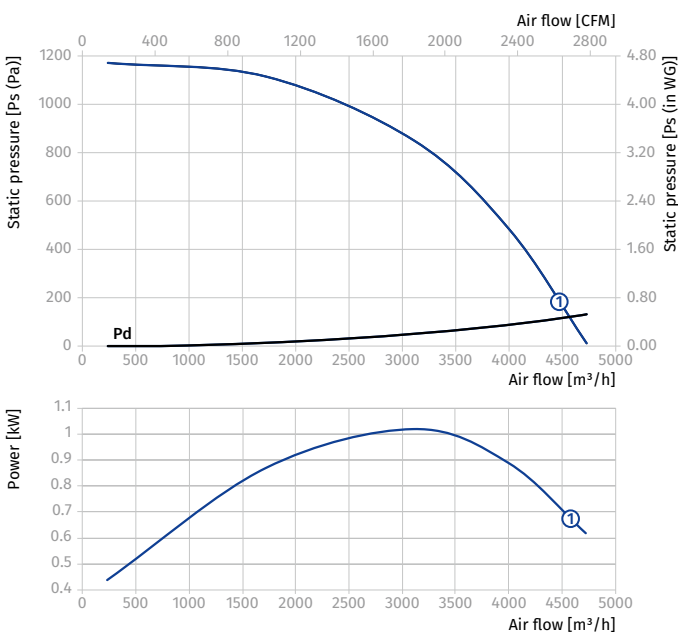

Standard size: 355

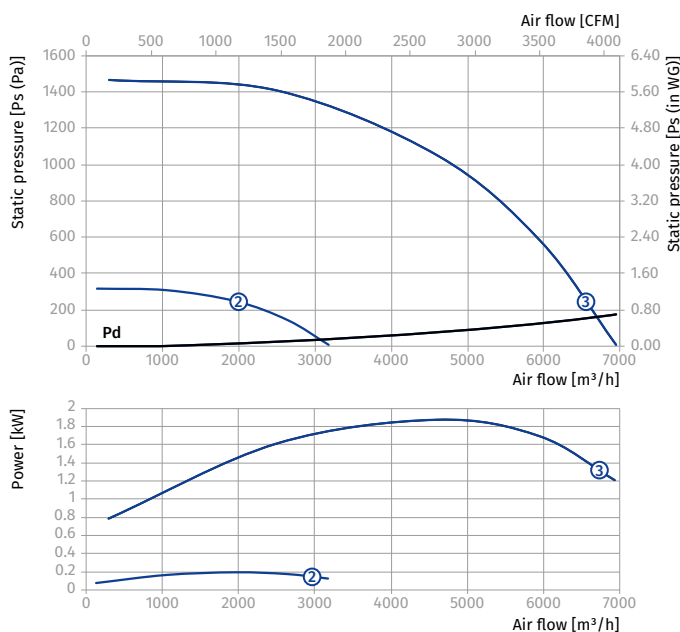

Standard size: 400

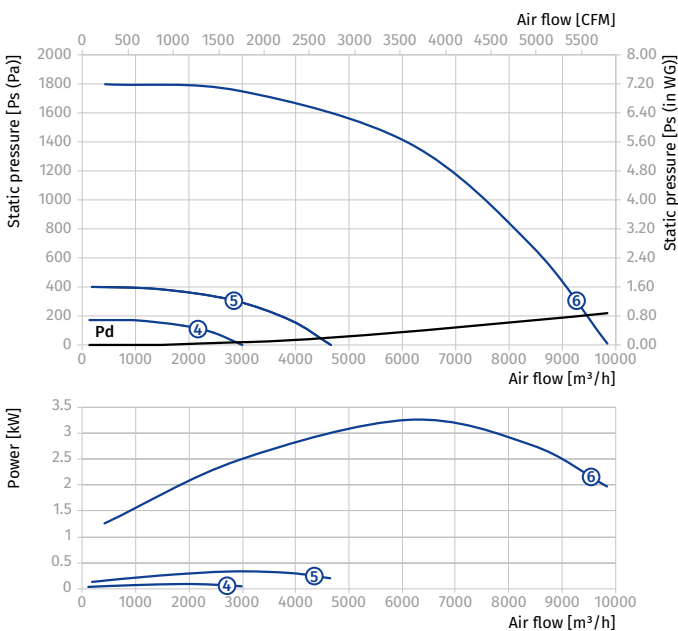

Standard size: 450

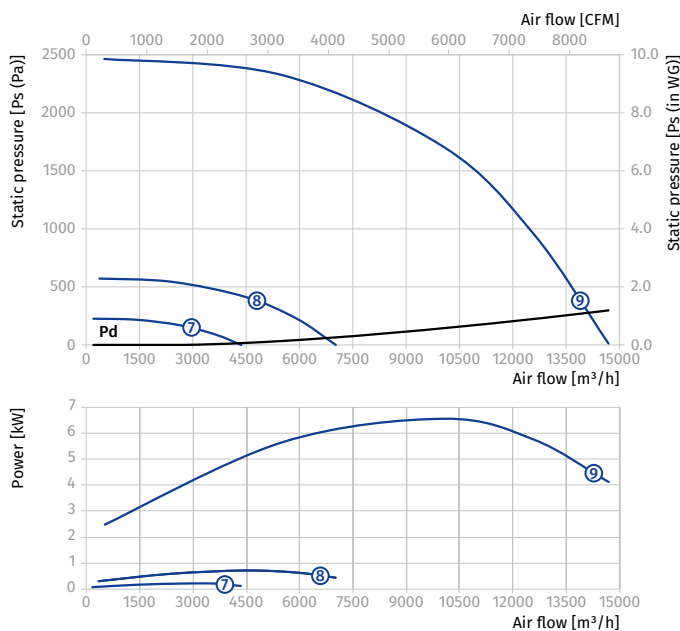

Standard size	Number of poles	Voltage [V/50 Hz]	Fan model	Rated power Ny [kW]	RPM [min ⁻¹]	Curve number
500	8	3~400	Tower-SV-K2 500-8D/0.25-K	0.25	670	①
	6	3~400	Tower-SV-K2 500-6D/0.55-K	0.55	900	②
	4	3~400	Tower-SV-K2 500-4D/1.5-K	1.5	1430	③
560	8	3~400	Tower-SV-K2 560-8D/0.37-K	0.37	665	④
	6	3~400	Tower-SV-K2 560-6D/0.75-K	0.75	940	⑤
	4	3~400	Tower-SV-K2 560-4D/3-K	3	1435	⑥
630	8	3~400	Tower-SV-K2 630-8D/0.75-K	0.75	670	⑦
	6	3~400	Tower-SV-K2 630-6D/1.5-K	1.5	940	⑧
	4	3~400	Tower-SV-K2 630-4D/5.5-K	5.5	1400	⑨
710	8	3~400	Tower-SV-K2 710-8D/1.1-K	1.1	660	⑩
	6	3~400	Tower-SV-K2 710-6D/2.2-K	2.2	945	⑪
	4	3~400	Tower-SV-K2 710-4D/11-K	11	1460	⑫

Standard size: 500

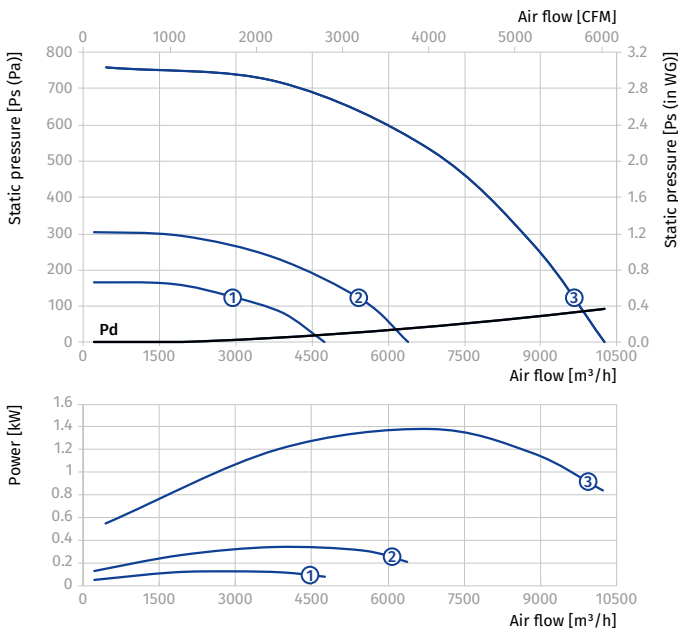

Standard size: 560

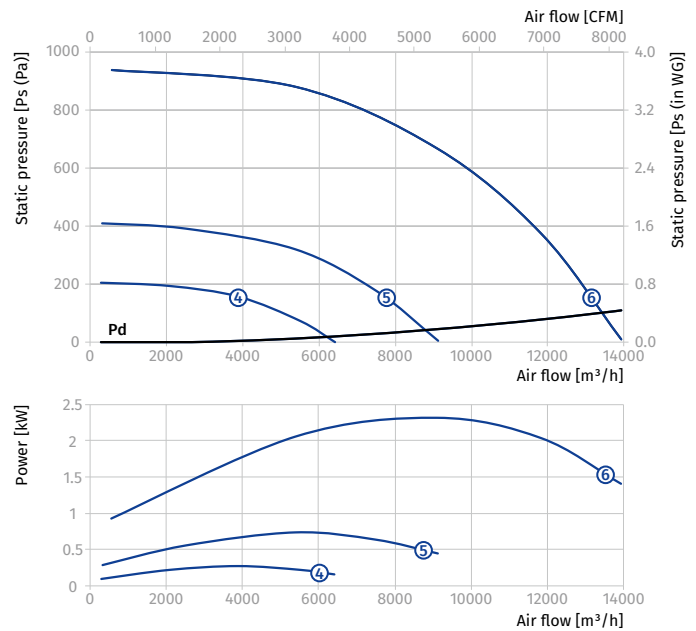

Standard size: 630

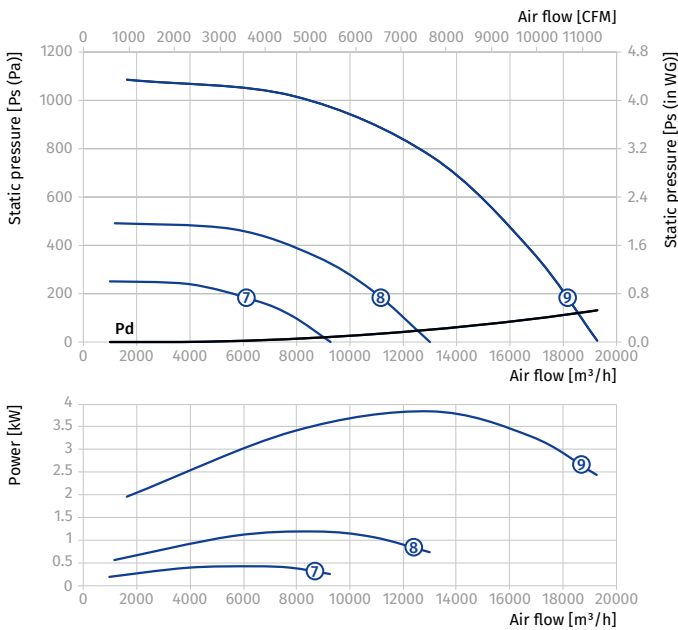

Standard size: 710

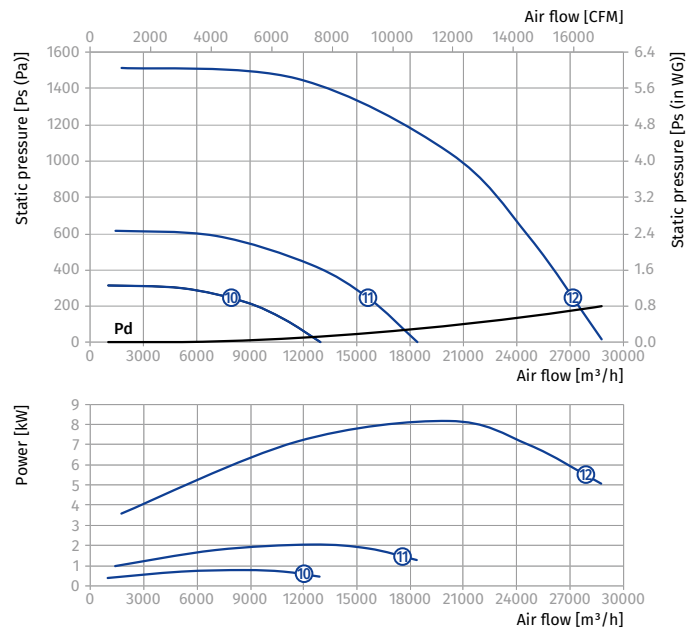

Standard size	Number of poles	Voltage [V/50 Hz]	Fan model	Rated power Ny [kW]	RPM [min ⁻¹]	Curve number
800	8	3~400	Tower-SV-K2 800-8D/2.2-K	2.2	700	①
	6	3~400	Tower-SV-K2 800-6D/4-K	4	965	②
	4	3~400	Tower-SV-K2 800-4D/15-K	15	1460	③
900	10	3~400	Tower-SV-K2 900-10D/2.2-K	2.2	590	④
	8	3~400	Tower-SV-K2 900-8D/4-K	4	700	⑤
	6	3~400	Tower-SV-K2 900-6D/7.5-K	7.5	970	⑥
	4	3~400	Tower-SV-K2 900-4D/30-K	30	1470	⑦
1000	10	3~400	Tower-SV-K2 1000-10D/3-K	3	590	⑧
	8	3~400	Tower-SV-K2 1000-8D/7.5-K	7.5	705	⑨
	6	3~400	Tower-SV-K2 1000-6D/15-K	15	975	⑩
1120	10	3~400	Tower-SV-K2 1120-10D/7.5-K	7.5	590	⑪
	8	3~400	Tower-SV-K2 1120-8D/11-K	11	720	⑫
	8	3~400	Tower-SV-K2 1120-8D/15-K	15	730	⑬
	6	3~400	Tower-SV-K2 1120-6D/22-K	22	975	⑭
	6	3~400	Tower-SV-K2 1120-6D/30-K	30	980	⑮

Standard size: 800

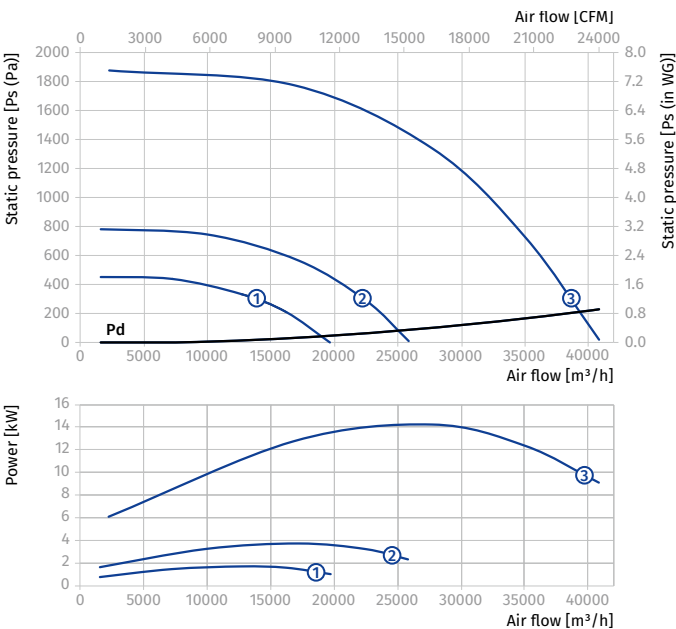

Standard size: 900

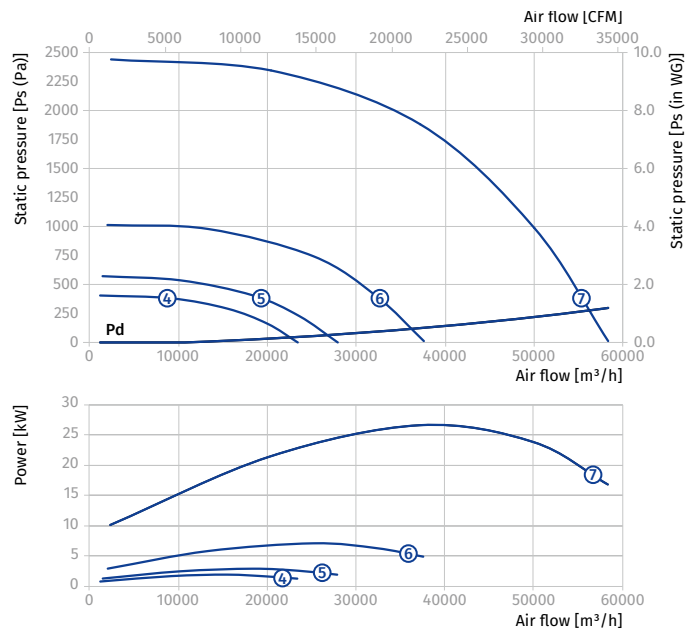

Standard size: 1000

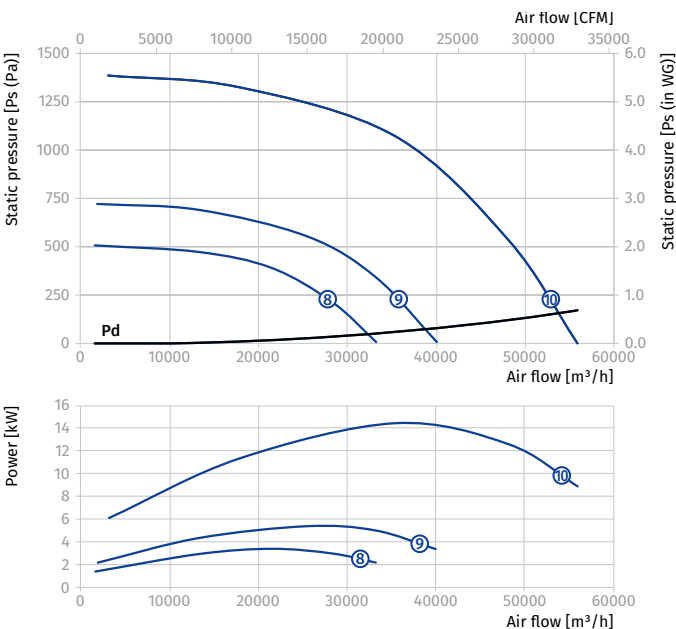

Standard size: 1120

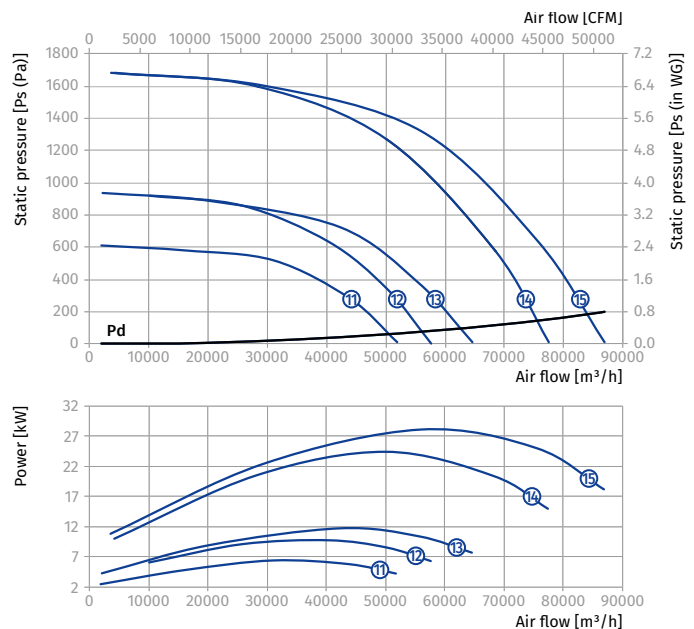

ROOF-MOUNTED SMOKE EXTRACTION FANS

BOX-S

Duct smoke extraction fan

Use

- The dual-purpose fan is used in emergency exhaust ventilation systems for forced removal of smoke, heated gases and combustion products, as well as for general exhaust ventilation of shopping centres, garages, warehouses, kitchens.



Air flow:
up to 28 500 m³/h



Transported air temperature:
400 °C/2 hours



Operation

- The fan is designed to remove smoke and air mixtures up to +400 °C for 120 minutes and for continuous operation at a temperature of the transported medium up to +100 °C.
- The fans can be equipped with a frequency converter for controlling the rotation frequency.

Design

- The fan casing is made of galvanized steel.
- The impeller with backward curved blades made of heat-resisting steel.

Motor

- The fans can be equipped with a single- or three-phase electric motor with power from 0.37 to 7.5 kW, degree of protection IP54 and designed for connection to 230/400 V, 50(60) Hz power mains.
- Single-speed fans are equipped with 2 or 4 pole motors.
- Two-speed fans are equipped with 2/4, 4/6, 4/8 pole motors.
- The electric motor is installed outside the air flow.

Overall dimensions [mm]

Model	A	A1	A2	B	B1	B2	C	D	Weight [kg]
BOX-S 25	500	520	540	300	320	340	680	557	40
BOX-S 28	600	620	640	300	320	340	680	558	40
BOX-S 31	600	620	640	350	370	390	680	624	56
BOX-S 35	700	720	740	400	420	440	680	657	51
BOX-S 40	700	720	740	500	520	540	680	772	70
BOX-S 40...60Hz	700	720	740	500	520	540	680	816	66
BOX-S 45	800	820	840	600	620	640	800	872	89
BOX-S 45...60Hz	800	820	840	600	620	640	800	918	83
BOX-S 50	800	820	840	600	620	640	840	914	97
BOX-S 50...60Hz	800	820	840	600	620	640	840	954	95
BOX-S 56	900	920	940	700	720	740	840	1058	100
BOX-S 56...60Hz	900	920	940	700	720	740	840	1103	118
BOX-S 63	1000	1020	1040	800	820	840	1040	1150	130
BOX-S 71	1200	1220	1245	900	920	945	1040	1354	178

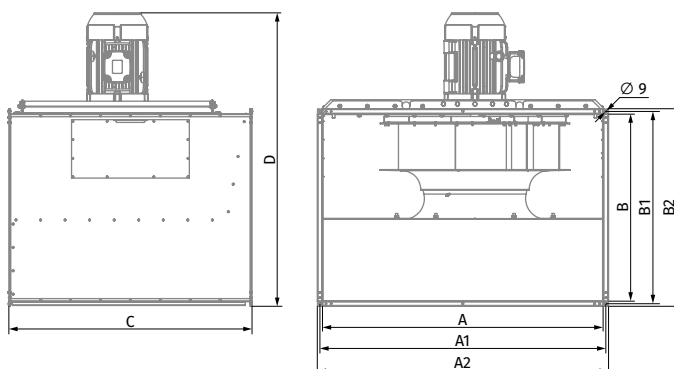

Designation key

Model	Impeller standard size [cm]	Pole number	Number of phases	Motor power [kW]	Spigot dimension [cm]	Frequency, Hz
BOX-S: rectangular duct fan for smoke removal	25; 28; 31; 35; 40; 45; 50; 56; 63; 71	2: single-speed fan 4: single-speed fan 6: single-speed fan 2/4: two-speed fan 4/6: two-speed fan	E: single-phase D: three-phase	x: single-speed x/x: two-speed	50x30; 60x30; 60x35; 70x40; 70x50; 80x60; 90x70; 100x80; 120x90	_: 50 Hz 60Hz: 60 Hz

DUCT SMOKE EXTRACTION FANS

Technical data

Standard size	Number of poles	Voltage [V/50 Hz]	Fan model	Rated power Ny [kW]	RPM [min ⁻¹]	High speed chart number	Low speed chart number
250	2	1~230	BOX-S 25-2E/0.37-50x30	0.37	2880	①	-
	2	3~400	BOX-S 25-2D/0.37-50x30	0.37	2880	①	-
	2/4	3~400	BOX-S 25-2/4D/0.37/0.1-50x30	0.37/0.1	2880/1440	①	②
280	2	1~230	BOX-S 28-2E/0.55-60x30	0.55	2880	③	-
	2	3~400	BOX-S 28-2D/0.55-60x30	0.55	2880	③	-
	2/4	3~400	BOX-S 28-2/4D/0.55/0.1-60x30	0.55/0.1	2880/1440	③	④
315	2	1~230	BOX-S 31-2E/1.1-60x35	1.1	2880	⑤	-
	2	3~400	BOX-S 31-2D/1.1-60x35	1.1	2880	⑤	-
	2/4	3~400	BOX-S 31-2/4D/1.1/0.25-60x35	1.1/0.25	2880/1440	⑤	⑥
355	4	1~230	BOX-S 35-4E/0.37-70x40	0.37	1420	⑦	-
	4	3~400	BOX-S 35-4D/0.37-70x40	0.37	1420	⑦	-
	4/6	3~400	BOX-S 35-4/6D/0.55/0.1-70x40	0.55/0.1	1420/905	⑦	⑧

Standard size: 25

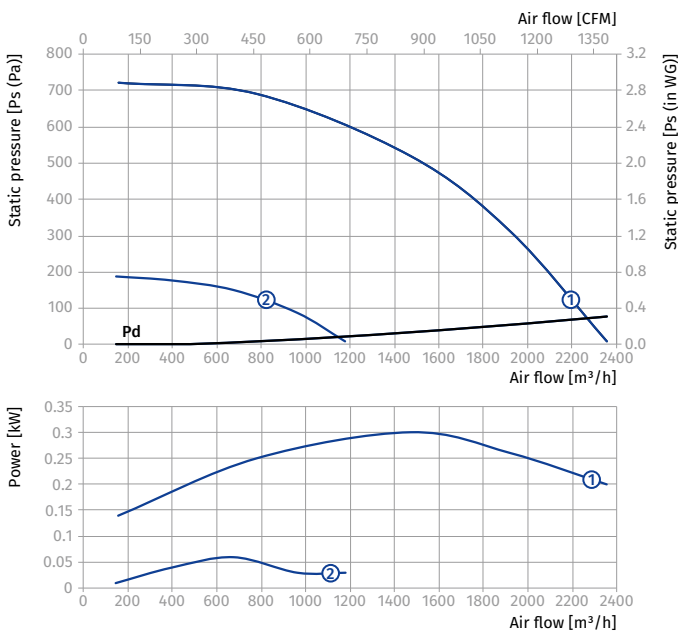

Standard size: 28

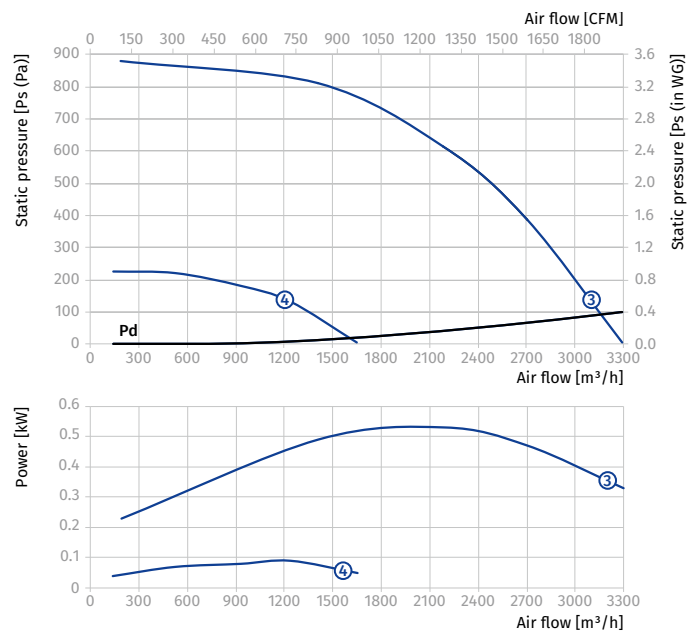

Standard size: 31

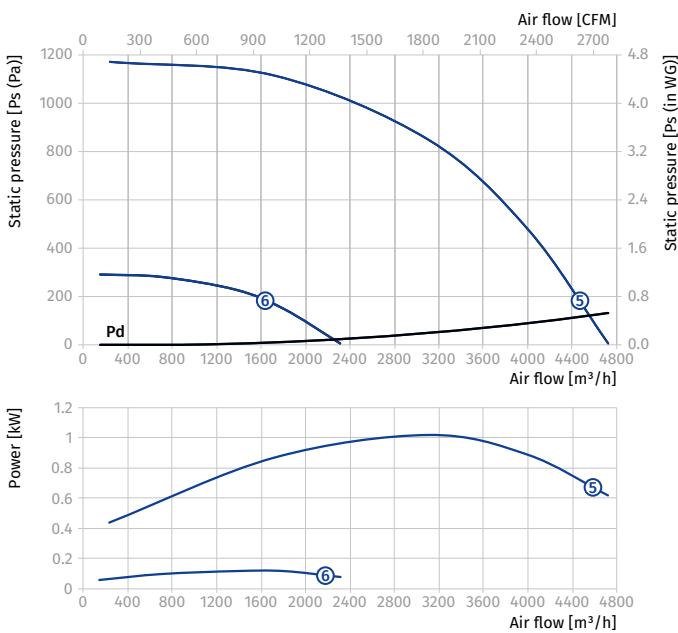

Standard size: 35

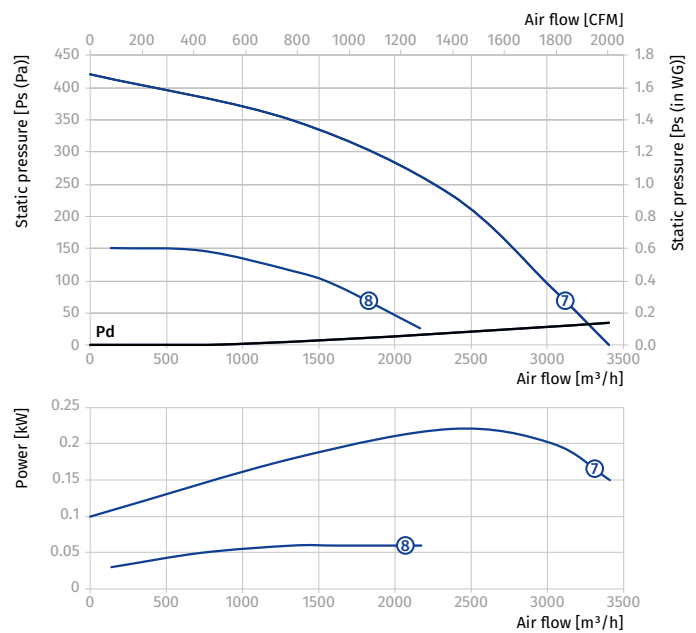

Standard size	Number of poles	Voltage [V/50 Hz]	Fan model	Rated power Ny [kW]	RPM [min ⁻¹]	High speed chart number	Low speed chart number
400	4	1~230	BOX-S 40-4E/0.55-70x50	0.55	1420	①	-
	4	3~400	BOX-S 40-4D/0.55-70x50	0.55	1420	①	-
	4/6	3~400	BOX-S 40-4/6D/0.55/0.25-70x50	0.55/0.25	1420/905	①	②
450	4	1~230	BOX-S 45-4E/0.75-80x60	0.75	1435	③	-
	4	3~400	BOX-S 45-4D/0.75-80x60	0.75	1435	③	-
	4/6	3~400	BOX-S 45-4/6D/0.8/0.2-80x60	0.8/0.2	1435/905	③	④
500	4	1~230	BOX-S 50-4E/1.5-80x60	1.5	1430	⑤	-
	4	3~400	BOX-S 50-4D/1.5-80x60	1.5	1430	⑤	-
	4/6	3~400	BOX-S 50-4/6D/1.5/0.37-80x60	1.5/0.37	1430/920	⑤	⑥
560	4	1~230	BOX-S 56-4E/3-90x70	3	1435	⑦	-
	4	3~400	BOX-S 56-4D/3-90x70	3	1435	⑦	-
	4/6	3~400	BOX-S 56-4/6D/2.8/0.7-90x70	2.8/0.7	1435/950	⑦	⑧
	4/8	3~400	BOX-S 56-4/8D/2.8/0.55-90x70	2.8/0.55	1435/710	⑦	⑨

Standard size: 40

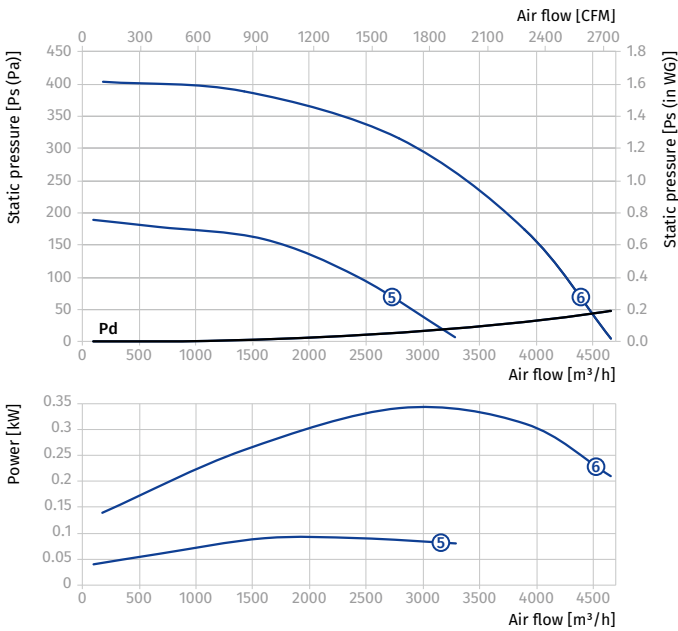

Standard size: 45

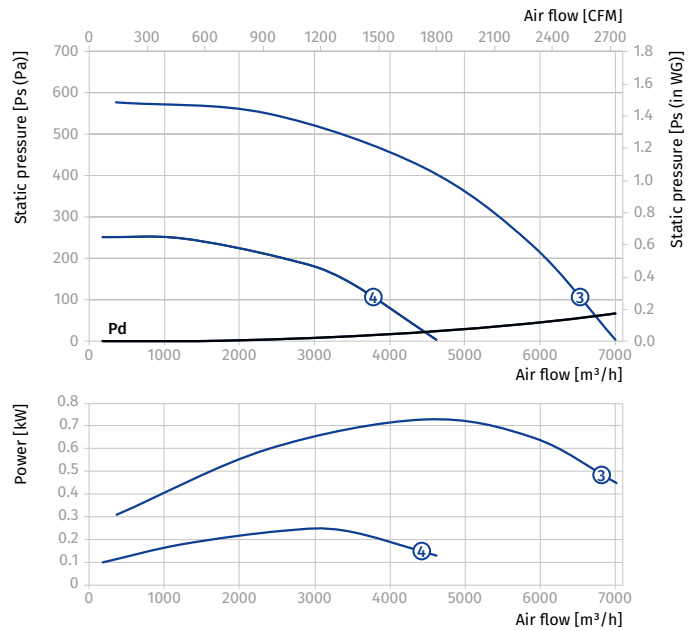

Standard size: 50

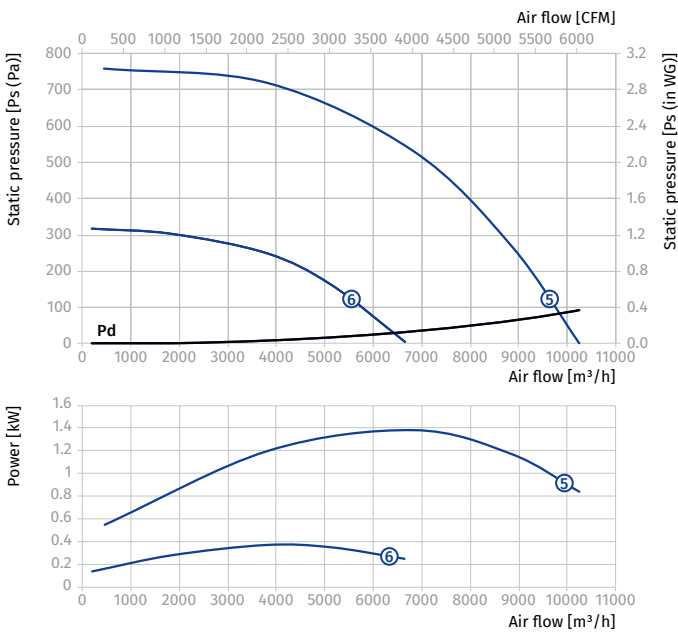

Standard size: 56

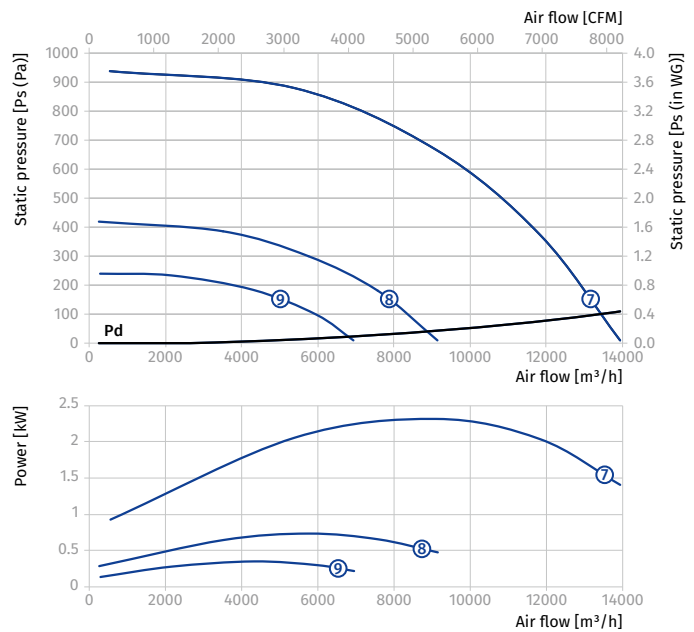

Standard size	Number of poles	Voltage [V/50 Hz]	Fan model	Rated power Ny [kW]	RPM [min ⁻¹]	High speed chart number	Low speed chart number
630	4	3~400	BOX-S 63-4D/4-100x80	4	1445	①	-
	4/6	3~400	BOX-S 63-4/6D/3.8/1-100x80	3.8/1	1445/950	①	②
	4/8	3~400	BOX-S 63-4/8D/3.8/0.75-100x80	3.8/0.75	1445/720	①	③
710	4	3~400	BOX-S 71-4D/7.5-120x90	7.5	1455	④	-
	4/6	3~400	BOX-S 71-4/6D/7.5/2.2-120x90	7.5/2.2	1455/960	④	⑤
	4/8	3~400	BOX-S 71-4/8D/7.5/1-120x90	7.5/1	1455/720	④	⑥

Standard size: 63

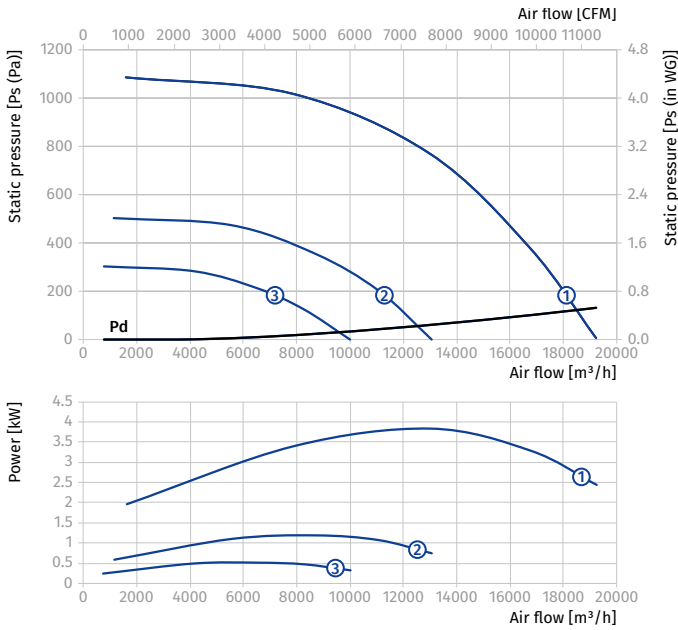

Standard size: 71

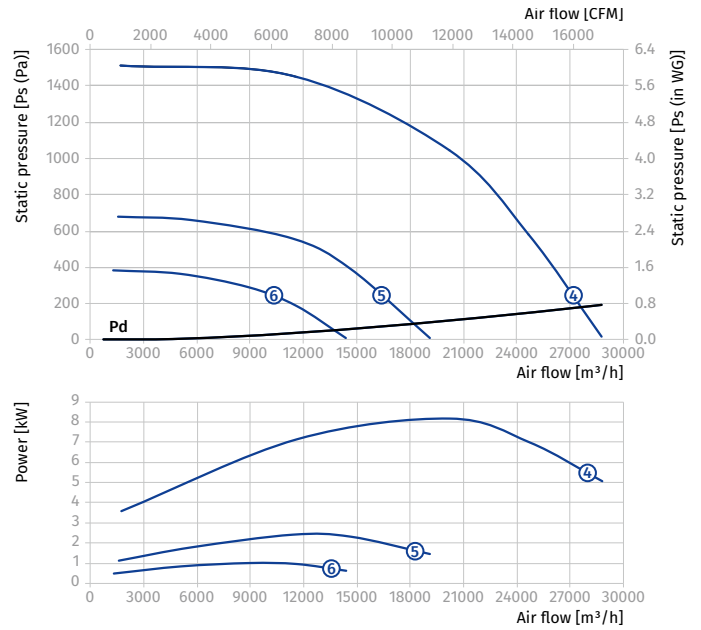

Standard size	Number of poles	Voltage [V/50 Hz]	Fan model	Rated power N_y [kW]	RPM [min ⁻¹]	Speed chart number
40	4	3~400	BOX-S 40-4D/1.1-70x50-60Hz	1,1	1749	①
45	4	3~400	BOX-S 45-4D/1.5-80x60-60Hz	1,5	1744	②
50	4	3~400	BOX-S 50-4D/2.2-80x60-60Hz	2,2	1748	③
56	4	3~400	BOX-S 56-4D/4.0-90x70-60Hz	4	1764	④

Standard size: 40

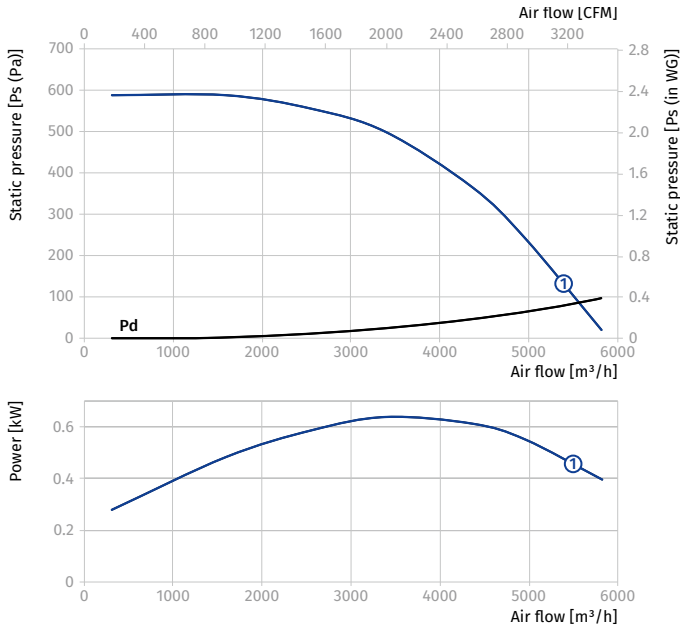

Standard size: 45

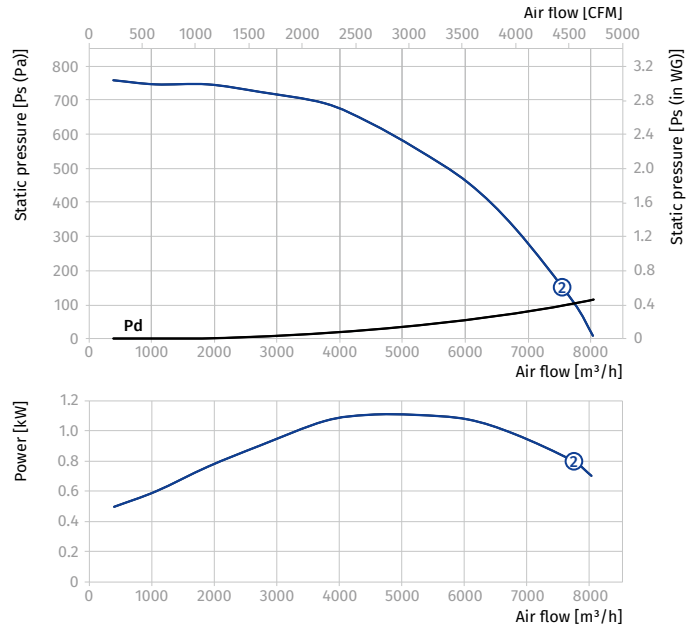

Standard size: 50

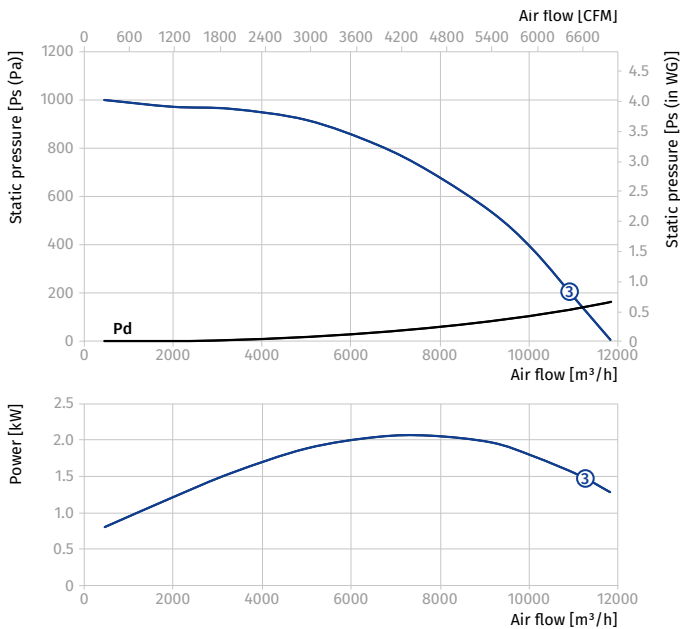

Standard size: 56

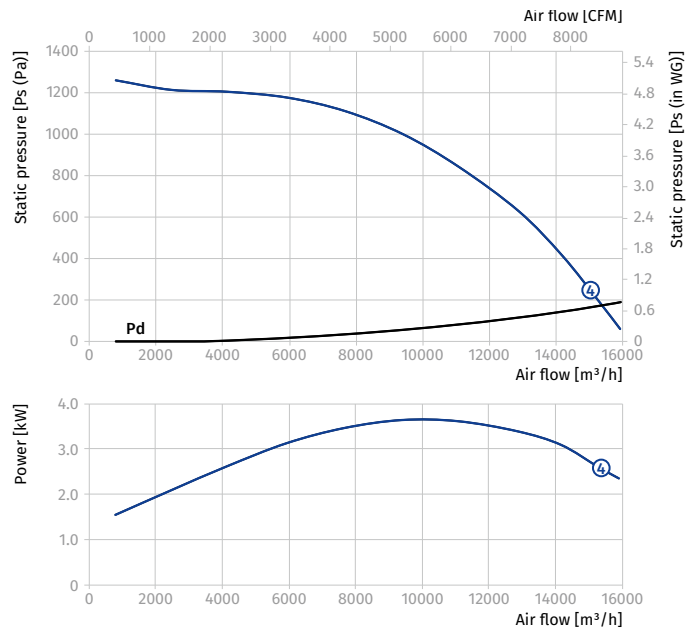

ACCESSORIES FOR ROOF-MOUNTED SMOKE EXTRACTION FANS

MOUNTING CURB SM-AF

- o The unit is used for mounting fans on rooftops.
- o The outer frames are supported for installation on the roof. The mounting curb is equipped with a side inspection door. Modifications are available to order according to the naming system.

Designation key

Series	Roof type	Heat insulation	Built-in damper availability:	Damper drive type	Diameter [mm]
SM-AF	0: for installation on a roof without a slope 1: for installation on a roof with a slope	0: no heat insulation 1: with heat insulation	0: no damper 1: exhaust damper 2: supply damper 3: smoke extraction damper	0: no drive 1: 24 V drive 2: 230 V drive	315; 355; 400; 450; 500; 560; 630; 710; 800; 900; 1000; 1120; 1250; 1400; 1600

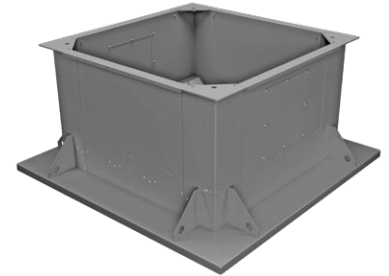

Model	Dimensions [mm]				Weight [kg]
	H	A	B	C	
SM-AF-0000-315/355					39.5
SM-AF-0010-315/355					43.5
SM-AF-0020-315/355	550	480	590	800	43.5
SM-AF-0100-315/355					50.5
SM-AF-0110-315/355					54.5
SM-AF-0120-315/355					54.5
SM-AF-0000-400/450					46
SM-AF-0010-400/450	550	580	692	900	51.5
SM-AF-0020-400/450					51.5
SM-AF-0100-400/450					58.5
SM-AF-0110-400/450					64
SM-AF-0120-400/450					64
SM-AF-0000-500	550	640	760	970	49
SM-AF-0010-500					56
SM-AF-0020-500					56
SM-AF-0100-500					63
SM-AF-0110-500					70
SM-AF-0120-500	70				
SM-AF-0000-560/630	550	750	910	1120	56.5
SM-AF-0010-560/630					66.5
SM-AF-0020-560/630					66.5
SM-AF-0100-560/630					72.5
SM-AF-0110-560/630					82.5
SM-AF-0120-560/630	82.5				
SM-AF-0000-710/800	550	980	1140	1350	68
SM-AF-0010-710/800					83
SM-AF-0020-710/800					83
SM-AF-0100-710/800					88
SM-AF-0110-710/800					103
SM-AF-0120-710/800	103				
SM-AF-0000-900	550	1050	1208	1420	71
SM-AF-0010-900					88.5
SM-AF-0020-900					88.5
SM-AF-0100-900					92
SM-AF-0110-900					109.5
SM-AF-0120-900	109.5				
SM-AF-0000-1000/1120	550	1340	1498	1710	85
SM-AF-0010-1000/1120					112
SM-AF-0020-1000/1120					115
SM-AF-0100-1000/1120					111
SM-AF-0110-1000/1120					137
SM-AF-0120-1000/1120	140				
SM-AF-0000-1250	550	1500	1688	1900	112
SM-AF-0010-1250					151
SM-AF-0020-1250					156
SM-AF-0100-1250					140
SM-AF-0110-1250					180
SM-AF-0120-1250	185				

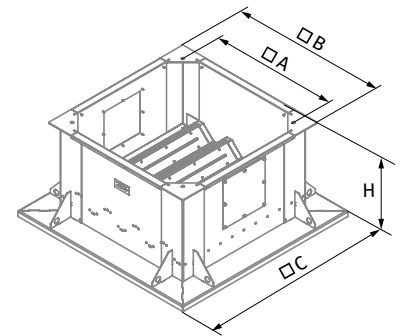

ACCESSORIES FOR ROOF-MOUNTED SMOKE EXTRACTION FANS

ACCESSORIES FOR DUCT SMOKE EXTRACTION FANS

Accessories selection table for BOX-S fans

Fan	Heat-resistant flexible joint up to 400 °C	Protective mesh
BOX-S 25...50x30	EVAF-BF-50x30	SZ-BF-50x30
BOX-S 28...60x30	EVAF-BF-60x30	SZ-BF-60x30
BOX-S 31...60x35	EVAF-BF-60x35	SZ-BF-60x35
BOX-S 35...70x40	EVAF-BF-70x40	SZ-BF-70x40
BOX-S 40...70x50	EVAF-BF-70x50	SZ-BF-70x50

Fan	Heat-resistant flexible joint up to 400 °C	Protective mesh
BOX-S 45...80x60	EVAF-BF-80x60	SZ-BF-80x60
BOX-S 50...80x60	EVAF-BF-80x60	SZ-BF-80x60
BOX-S 56...90x70	EVAF-BF-90x70	SZ-BF-90x70
BOX-S 63...100x80	EVAF-BF-100x80	SZ-BF-100x80
BOX-S 71...120x90	EVAF-BF-120x90	SZ-BF-120x90

FLEXIBLE JOINT EVAF-BF

- Flexible joints cancel out any potential vibrations transmitted by the fans or air handling units to the air ducting as well as partially compensate for the air duct assembly deformations caused by temperature variation.
- Flexible joints are formed by two flanges joined with vibration-absorbing material and are made of polymer-coated steel and PVC tape reinforced with polyamide fabric. The joints are not intended to withstand any significant mechanical loads and, therefore, may not be used as load-bearing structures. The **EVAF-BF** joints are designed for operation at a temperature of 400 °C for 2 hours..

Model	Dimensions [mm]					
	B	H	B1	H1	B2	H2
EVAF-BF-50x30	500	300	520	320	540	340
EVAF-BF-60x30	600	300	620	320	640	340
EVAF-BF-60x35	600	350	620	370	640	390
EVAF-BF-70x40	700	400	720	420	740	440
EVAF-BF-70x50	700	500	720	520	740	540
EVAF-BF-80x60	800	600	820	620	840	640
EVAF-BF-90x70	900	700	920	720	940	740
EVAF-BF-100x80	1000	800	1020	820	1040	840
EVAF-BF-120x90	1200	900	1220	920	1240	940

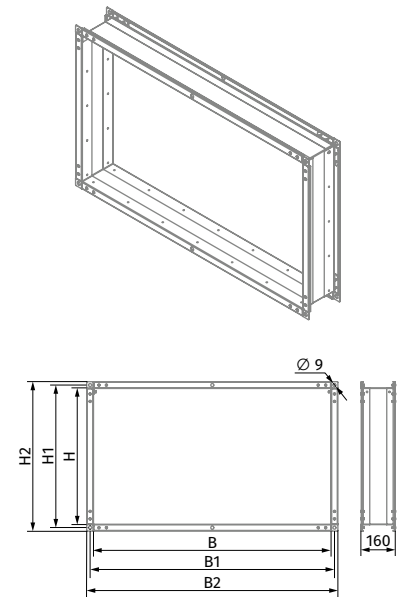

PROTECTIVE MESH SZ-BF

- Protects the fans against foreign objects.
- Protective mesh with 25x25 mm cells.

Model	Dimensions [mm]						
	B	H	B1	H1	B2	H2	L
SZ-BF-50x30	500	300	520	320	540	340	110
SZ-BF-60x30	600	300	620	320	640	340	110
SZ-BF-60x35	600	350	620	370	640	390	130
SZ-BF-70x40	700	400	720	420	740	440	145
SZ-BF-70x50	700	500	720	520	740	540	185
SZ-BF-80x60	800	600	820	620	840	640	220
SZ-BF-90x70	900	700	920	720	940	740	255
SZ-BF-100x80	1000	800	1020	820	1040	840	295
SZ-BF-120x90	1200	900	1220	920	1240	940	330

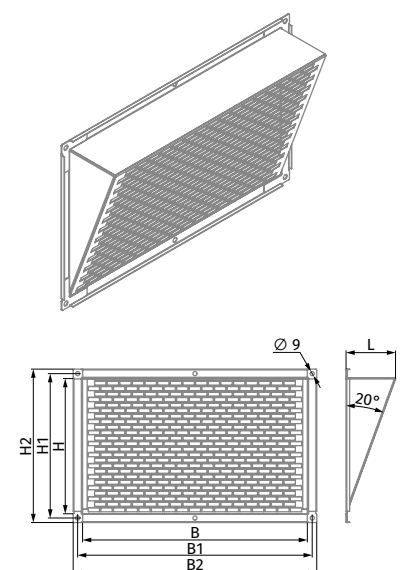

OPERATION OF FANS WITH FREQUENCY CONVERTERS

Ventilation systems produce a heavy load on the electrical systems of a building. Therefore, reducing the power consumption is among the top priorities for construction project designers.

DIRECT ON-LINE STARTING (DOL)

As a rule, smoke extraction systems utilize large high-performance fans. During starting the high inertia of the shaft causes a substantial increase in the start-up time – i.e. the time from the application of power to reaching the rated speed. As a result the motor is subjected to high starting current for a prolonged period of time.

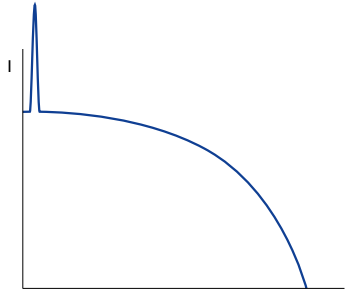

Current diagram with direct on-line starting

Standard switchgear (automatic circuit breakers, contactors and motor starters) is not designed to withstand prolonged overloads causing the fan to shut down automatically during starting. Using switchgear with a higher maximum current rating renders the electric motor protection system less sensitive.

As a result the switchgear will not be able to detect motor overload in time due to a higher current sensing threshold. Such challenges can only be addressed by utilizing a soft starter or a frequency converter to start the fan without causing a prolonged overload.

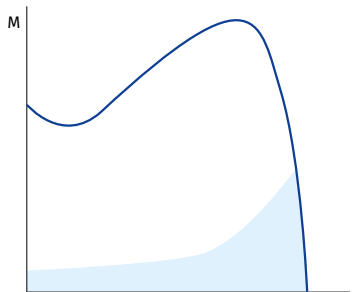

Torque diagram with direct on-line starting

FREQUENCY CONVERTER

A frequency converter (FC) consists of two main component blocks. One converts alternating current (50 or 60 Hz) into direct current. The other converts direct current into alternating current of variable frequency ranging from 0 to 250 Hz. By controlling the frequency output the FC offers a broad range of motor speed regulation.

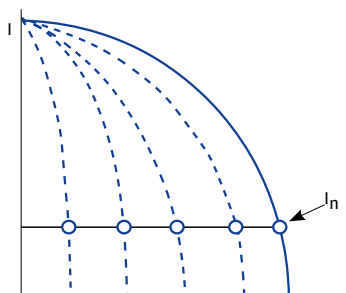

Current diagram with FC starting

During the starting the FC raises the frequency from 0 Hz to the electrical mains frequency (50 or 60 Hz).

As the frequency is increased gradually, the motor can be assumed to operate at its nominal speed for a given frequency value. Furthermore, on the assumption that the motor runs at its nominal speed the nominal torque should be immediately available whereas the current will be approximately equal to the nominal value.

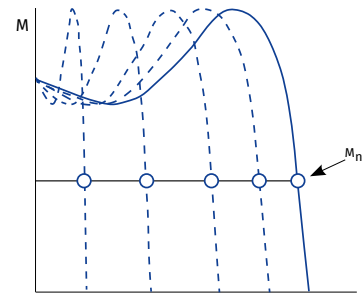

Torque diagram with FC starting

SOFT STARTER

Unlike an FC, a soft starter does not change the frequency of speed. Instead it gradually increases the voltage supplied to the motor – from the initial level to the nominal level.

The very low voltage initially supplied to the motor during starting helps avoid sudden jolts.

Both voltage and torque increase gradually.

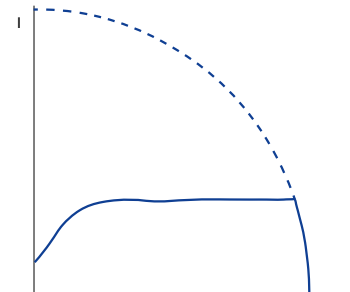

Current diagram with soft starter

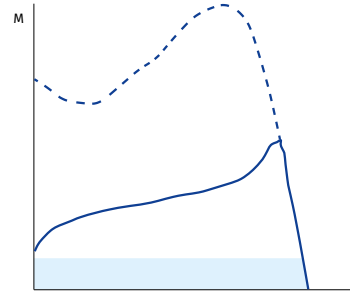

Torque diagram with soft starter

APPLICATIONS IN VENTILATION SYSTEMS

Using an FC or a soft starter allows to reduce the starting current thereby avoiding a loss of voltage in the electrical mains.

In addition to that the starting torque and mechanical strain on equipment are also reduced which translates into extended maintenance and repair intervals. General exhaust ventilation (GV) systems and emergency smoke extraction (SE) systems of car parks, warehouses, utility and industrial spaces can be integrated into a single system at the design level.

As the air flow rate a GV system is considerably lower than that in an SE system a high-capacity fan rated for smoke extraction duty runs in partial load mode.

Frequency converters can be programmed for several fixed-speed settings to enable operation in GV and SE modes.

The fan operating modes can be switched upon receiving an external signal from the control system.

Such integration of ventilation systems allows overall cost savings.

FC-51 AND FC-101: WHEN TO USE?

This catalogue features two series of frequency converters: FC-51 and FC-101.

The FC-51 series is only suitable for general ventilation systems.

If intended for a smoke extraction system, the fans should be fitted with the FC-101 series units as they feature an integrated fire mode.

When activated the integrated protection equipment of the frequency converter is overridden enabling the unit to continue operation despite the possibility of sustaining irreparable damage due to overheating or overloading.

In case of a fire, the FC-101 series frequency converters are capable of maintaining a higher air pressure level at landings compared to other areas of the building in order to keep the landings smoke-free.

MICRO DRIVE FC-51

Frequency converters

Use

- o This general-purpose variable frequency drive is designed for regulating the rotation speed of an AC electric motor with a maximum power output of 22 kW.
- o This unit is only suitable for general ventilation systems.



Features

- o The drive construction prevents forced air flow passage through its internal electronic components.
- o The internal circuit boards are well-protected.

Filter

- o The unit features an integrated HF filter which blocks RF interference from the motor and enables the use of a shielded cable up to 15 m long or unshielded cable up to 50 m long as per the applicable EU regulations.

Inputs and outputs

- o 5 programmable digital inputs
- o PNP/NPN logic
- o 20-5000 Hz pulse input
- o One 0-10 V or 0-20 mA analogue input
- o One 0-20 mA analogue input
- o Thermistor input (analogue or digital)
- o 1 analogue output
- o 1 relay, 240 V, 2 A
- o RS 485
- o MODBUS RTU

Control panels



Designation	Code
VLT control panel LCP 11 (without potentiometer)	132B0100
VLT Control Panel LCP 12 (with potentiometer)	132B0101



Designation	Code
Remote panel mounting kit	132B0102

Installation

- o Back-to-back installation for space savings. Thanks to a compact design the drives can be mounted immediately next to one another without any performance penalties.

Frequency converter type and order code

Three-phase, 380-480 V			
Power [kW]	Rated current [A]	Order code	Block type
0.37	1.2	132F0017	M1
0.75	2.2	132F0018	M1
1.5	3.7	132F0020	M2
2.2	5.3	132F0022	M2
3.0	7.2	132F0024	M3
4.0	9.0	132F0026	M3
5.5	12.0	132F0028	M3
7.5	15.5	132F0030	M3
11.0	23.0	132F0058	M4
15.0	31.0	132F0059	M4
18.0	37.0	132F0060	M5
22.0	43.0	132F0061	M5

Outside dimensions (including mounting ledge)

mm	M1	M2	M3	M4	M5
Height	150	176	239	292	335
Width	70	75	90	125	165
Depth	148	168	194	241	248

+ 6 mm with potentiometer

BASIC DRIVE FC-101

Frequency converters



Use

- o This general-purpose variable frequency drive is designed for regulating the rotation speed of an AC electric motor with a maximum power output of 90 kW.
- o This drive is suitable for both general ventilation and smoke extraction ventilation systems.

Certified fire mode

- o The fire mode prevents the drive from a self-protecting shut-down. While in this mode the drive continues to perform speed regulation duty for mission-critical fans irrespective of control signals, warnings and alarms which may otherwise force it shut down.

Filter

- o A built-in throttle on the DC link ensures a low harmonic load on the power mains as per the EN 61000-3-12 standard requirements.

Inputs and outputs

- o Four PNP or NPN programmable digital inputs, 0-24 V DC
- o 2 analogue inputs (0-10 V or 0/4-20 mA)
- o 2 analogue outputs (0/4-20 mA)
- o 2 relay outputs
- o MODBUS RTU (RS 485)
- o BACnet MSTP
- o FC Protocol
- o N2 Metasys
- o FLN Apogee

Installation

- o Thanks to an ultra-compact design the drive can be easily fitted into a larger unit or panel of an air ventilation system. The casings are rated IP20/Type 1/IP21 (optional) and IP54.

Frequency converter type and SKU code

Power [kW]	Current [A]	VLT® FC 101 HVAC Basic Drive 0.37-90 kW (3 x 380 – 480 V-, without a braking transistor)			
0.37	1.2	-	131L9861	-	-
0.75	2.2	-	131L9862	131N0177	131N0178
1.5	3.7	-	131L9863	131N0179	131N0180
2.2	5.3	-	131L9864	131N0181	131N0182
3	7.2	-	131L9865	131N0183	131N0184
4	9.1	-	131L9866	131N0185	131N0186
5.5	12	-	131L9867	131N0187	131N0188
7.5	15.5	-	131L9868	131N0189	131N0190
11	23	-	131L9869	131N0191	131N0192
15	31	-	131L9870	131N0193	131N0194
18	37	-	131L9871	131N0195	131N0196
22	42.5	-	131L9872	131N0197	131N0198
30	61	131L9873	131L9875	131N0201	131N0202
37	73	131L9881	131L9883	131N0205	131N0206
45	90	131L9889	131L9891	131N0209	131N0210
55	106	131L9897	131L9899	131N0213	131N0214
75	147	131L9905	131L9907	131N0217	131N0218
90	177	131L9913	131L9915	131N0221	131N0222
Casing	(E20) IP20/Chassis	(E20) IP20/Chassis	IP54	IP54	IP54
EMC filter	(H2) RFI class A2 (for industrial areas)	(H3/H4) RFI class A1/B (for residential areas)	(H2) RFI class A2 (for industrial areas)	(H3) RFI class A1/B (for residential areas)	(H3) RFI class A1/B (for residential areas)
Control panel	(X) without panel	(X) without panel	Integral	Integral	Integral

VLT® HVAC Basic frequency converters rated up to 22 kW are fitted with circuit boards with a special class 3C3 protective coating. For frequency converters rated higher than 22 kW this protective coating is optional while, the 3C2 coating is standard.

VLT® FC 101 HVAC Basic Drive frequency converter options

Order code	Description
132B0200	Operator's digital panel
132B0201	Kit for remote mounting of the operator panel to an IP55 cabinet, including 3 m cable
132B0202	Decoupling plate for H1 and H2 standard sizes
132B0204	Decoupling plate for H3 standard size
132B0205	Decoupling plate for H4 and H5 standard sizes
132B0207	Decoupling plate for H6 standard size
132B0242	Decoupling plate for H6 standard size (extra large)

Order code	Description
132B0208	Decoupling plate for H7 standard size
132B0243	Decoupling plate for H7 standard size (extra large)
132B0209	Decoupling plate for H8 standard size
132B0244	External EMC filter class A1/B1 for power output from 0.37 to 2.2 kW
132B0245	External EMC filter class A1/B1 for power output from 3 to 7.5 kW
132B0246	External EMC filter class A1/B1 for power output from 11 to 15 kW
132B0247	External EMC filter class A1/B1 for power output from 18.5 to 22 kW

Blauberg Ventilatoren GmbH
Aidenbachstr. 52
D-81379 Munich

info@blaubergventilatoren.de
www.blaubergventilatoren.de

Technical changes reserved.
Illustrations and texts are non-binding.

02/2023