

AATZA

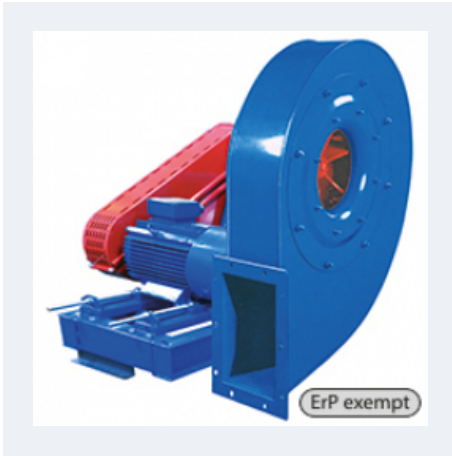

HIGH PRESSURE WITH STRAIGHT IMPELLER AND BELT TRANSMISSION

MANUFACTURING FEATURES:

- Fan made of Fe360 sheet. The fan paint finish is based on a Qualicoat polyester powder coating stoved at 200°C, with an average film thickness of 70 microns. Average heat resistance of coating is 180°C with peaks of 200°C.
- Fully welded housing.
- High efficiency simple inlet straight blade impeller made of Fe360 sheet statically and dynamically balanced. Impellers are painted with polyester primer that resists temperatures up to 300°C.
- Motorized fan with base frame (configuration 12). Full equipped fans including: motor, pulleys, belts, belts guard and shaft guard. Fitted over a base plate.
- Standard orientation LG270.
- It allows adjusting the orientation locally from models 400 to 630. Models sizes from 710 to 1000 size the orientation is fixed.

APPLICATIONS:

- Designed for inline installation, they are suitable for:
- Industrial applications, extraction or injection of air.
 - Cooling of machines and parts.
 - Exhaust after filters, separators and cyclones.
 - Pneumatic transport.
 - Solid material transport and textile fibers.
 - Maximum working temperature: carried air: 130°C, ambient: 60°C.

UNDER REQUEST

- Fans for 60Hz and special voltages.
- 2 speed motor.
- Fan with free shaft (configuration 1) or with motor supported on the pedestal side (configuration 9).
- C4 or C5 coating painting
- Hot dip galvanized
- Special steel (Cor-Ten A, Hardox...)
- Inox 304 (normal or electropolished finish)
- Inox 316 (normal or electropolished finish)
- Cooling wheel
- Anticaloric paint
- Reinforced housing
- Fully welded housing (waterproof)
- Insulated housing
- Split casing (for big sizes)
- Inspection door to facilitate maintenance and cleaning
- Drain plug.
- Airtight axle
- Frontal foot
- Double suction flange
- Available in non-sparking air passage and standard motor.
- Other brands of motors.
- Orientation: RD0, RD45, RD90, RD135, RD180, RD225, RD270, RD315, LG0, LG45, LG90, LG135, LG180. LG225, LG315.

Accessories



AB



AC



AVR



AVS



BA-400



BAD



EI



FS



INT



JE 45



RA



RI



SFC

Technical data

Three-phase motor

Code	Model	RPM	Min. Rated power kW	Max. Rated power kW	Max. Airflow m ³ /h	Sound db (A)**	Weight t*	Connect. diagram
5064040__R__	AATZA 400	2350 - 3500	1,10	4	640	53	37	1
5064045__R__	AATZA 450	2150 - 3500	0,37	5,50	830	57	48	1
5064050__R__	AATZA 500	1900 - 3500	0,37	5,50	1.130	62	68	1
5064056__R__	AATZA 560	1700 - 3500	0,55	7,50	1.570	67	91	1
5064063__R__	AATZA 630	1500 - 3300	1,10	9	2.230	66	118	1
5064071__R__	AATZA 710	1350 - 2900	1,50	11	2.510	68	179	1
5064080__R__	AATZA 800	1200 - 2600	1,10	15	3.770	66	217	1
5064090__R__	AATZA 900	1050 - 2300	3	18,50	4.790	68	280	1
5064100__R__	AATZA 1000	950 - 2100	4	22	5.780	69	365	1

Notes:

* The motor is not included in fan weight

** Total sound pressure level at the point of maximum flow measured in dB(A) in the suction measured in free field at a distance of 6m from the source

Dimensions

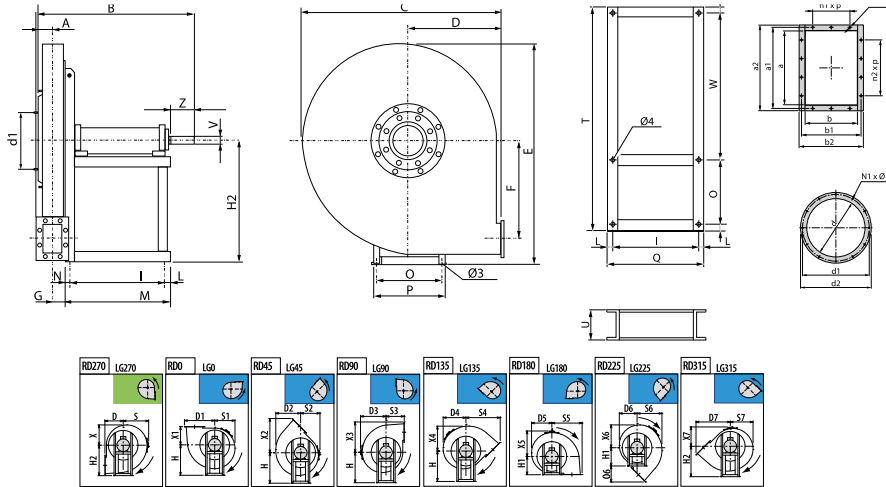

Model	A	B	C	D	D1	D2	D3	D4	D5
AATZA 400	42	514	620	280	351	314	340	302	282
AATZA 450	46	522	675	300	388	350	375	335	313
AATZA 500	52	677	745	335	431	386	410	370	345
AATZA 560	59	688	835	375	483	438	460	418	391
AATZA 630	65	723	940	425	544	493	515	472	441

Model	D6	D7	E	F	G	H	H1	H2	I
AATZA 400	293	445	657	273	38	375	375	375	284
AATZA 450	319	486	713	305	42	400	400	400	284
AATZA 500	350	541	795	342	47	450	450	450	407
AATZA 560	392	606	891	387	53	500	500	500	407
AATZA 630	438	688	1001	436	58	560	560	560	407

Model	L	M	N	N1xØ1	N2xØ2	O	O6	P	Q
AATZA 400	23	347	40	Nº4 M6x20	4x10	288	165	324	330
AATZA 450	23	347	40	Nº8 M6x20	4x10	288	186	324	330
AATZA 500	28	485	50	Nº8 M6x20	4x10	355	206	400	463
AATZA 560	28	485	50	Nº8 M6x20	6x10	355	231	400	463
AATZA 630	28	485	50	Nº8 M6x20	6x12	355	263	400	463

Model	R	S	S1	S2	S3	S4	S5	S6	S7
AATZA 400	18	340	282	293	280	445	351	314	302
AATZA 450	18	375	313	319	300	486	388	350	335
AATZA 500	23	410	345	350	335	541	431	386	370
AATZA 560	23	460	391	392	375	606	483	438	418
AATZA 630	23	515	441	438	425	688	544	493	472

Model	T	U	V	W	X	X1	X2	X3	X4
AATZA 400	900	100	24	576	282	280	445	351	314
AATZA 450	900	100	24	576	313	300	486	388	350
AATZA 500	1060	120	28	660	345	335	541	431	386
AATZA 560	1180	120	28	780	391	375	606	483	438
AATZA 630	1180	120	38	780	441	425	688	544	493

Model	X5	X6	X7	Z	a	a1	a2	b	b1
AATZA 400	340	302	293	50	95	129	155	68	102
AATZA 450	375	335	319	50	105	139	165	76	110
AATZA 500	410	370	350	60	117	151	177	85	119
AATZA 560	460	418	392	60	131	165	191	95	129
AATZA 630	515	472	438	80	146	182	216	105	139

Model	b2	d	d1	d2	n2xp	Ø3	Ø4
AATZA 400	128	130	165	190	-	14	14
AATZA 450	136	145	182	215	-	12	14
AATZA 500	145	165	200	235	-	14	14
AATZA 560	155	185	219	250	1x100	14	14
AATZA 630	175	205	241	275	1x112	14	14

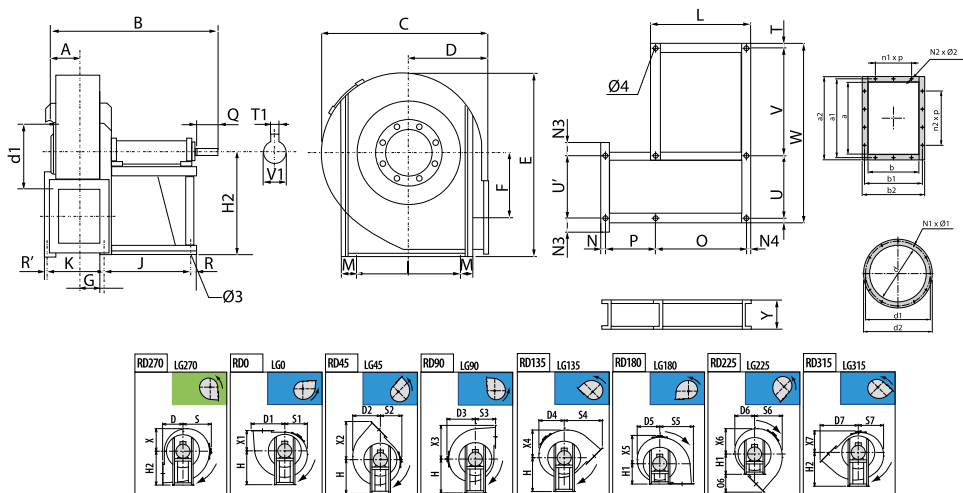

Model	A	B	C	D	D1	D2	D3	D4	D5
AATZA 710	70	835	1045	475	606	547	570	522	492
AATZA 800	78	850	1170	530	679	622	640	592	554
AATZA 900	86	870	1315	600	759	696	715	668	628
AATZA 1000	95	975	1460	670	841	775	790	735	691

Model	D6	D7	E	F	G	H	H1	H2	I
AATZA 710	489	764	1122	488	101,5	630	630	630	485
AATZA 800	545	854	1264	551	108,5	710	710	710	485
AATZA 900	617	961	1428	620	120,5	800	800	800	485
AATZA 1000	670	1072	1591	690	139,5	900	900	900	762

Model	J	K	L	M	N	N1xØ1	N2xØ2	N3	N4
AATZA 710	477	203	543	23	20	Nº8 M8x25	6x12	55	33
AATZA 800	477	217	543	23	20	Nº8 M8x25	6x12	60	33
AATZA 900	477	241	543	23	25	Nº8 M8x25	8x12	70	33
AATZA 1000	551	279	629	32	35	Nº8 M8x25	8x12	150	39

Model	O	O6	P	Q	R	R'	S	S1	S2
AATZA 710	477	289	203	110	33	20	570	492	489
AATZA 800	477	324	217	110	33	20	640	554	545
AATZA 900	477	361	241	110	33	25	715	628	617
AATZA 1000	551	172	279	110	39	35	790	691	670

Model	S3	S4	S5	S6	S7	T	T1	U	U'
AATZA 710	475	764	606	547	522	23	12	485	410
AATZA 800	530	854	679	622	592	23	12	485	420
AATZA 900	600	961	759	696	668	23	14	485	485
AATZA 1000	670	1072	841	775	735	32	14	762	526

Model	V	V1	W	X	X1	X2	X3	X4	X5
AATZA 710	720	42	1250	492	475	764	606	547	570
AATZA 800	970	42	1500	554	530	854	679	622	640
AATZA 900	970	48	1500	628	600	961	759	696	715
AATZA 1000	974	48	1800	691	670	1072	841	775	790

Model	X6	X7	Y	a	a1	a2	b	b1	b2
AATZA 710	522	489	160	166	200	236	117	151	187
AATZA 800	592	545	160	185	219	255	131	165	201

Model	X6	X7	Y	a	a1	a2	b	b1	b2
AATZA 900	668	617	160	207	241	277	148	182	218
AATZA 1000	735	670	180	231	265	301	166	200	236

Model	d	d1	d2	n1xp	n2xp	Ø3	Ø4
AATZA 710	228	265	298	-	1x112	19	19
AATZA 800	255	292	325	-	1x112	19	19
AATZA 900	285	332	365	1x112	1x112	19	19
AATZA 1000	320	366	400	1x112	1x112	24	20

Wiring diagram

DIAGRAM N° 1

230/400V

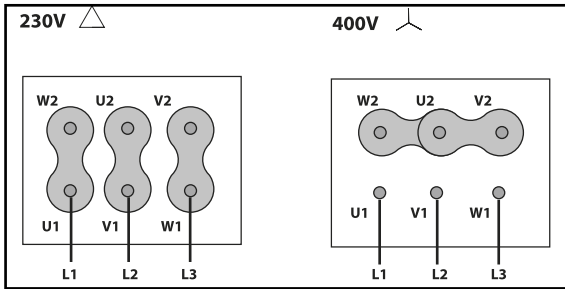

400/690V

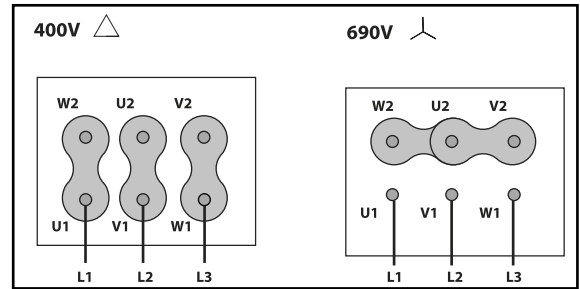

CHARACTERISTIC CURVE

AATZA 400

AIR FLOW - PRESSURE

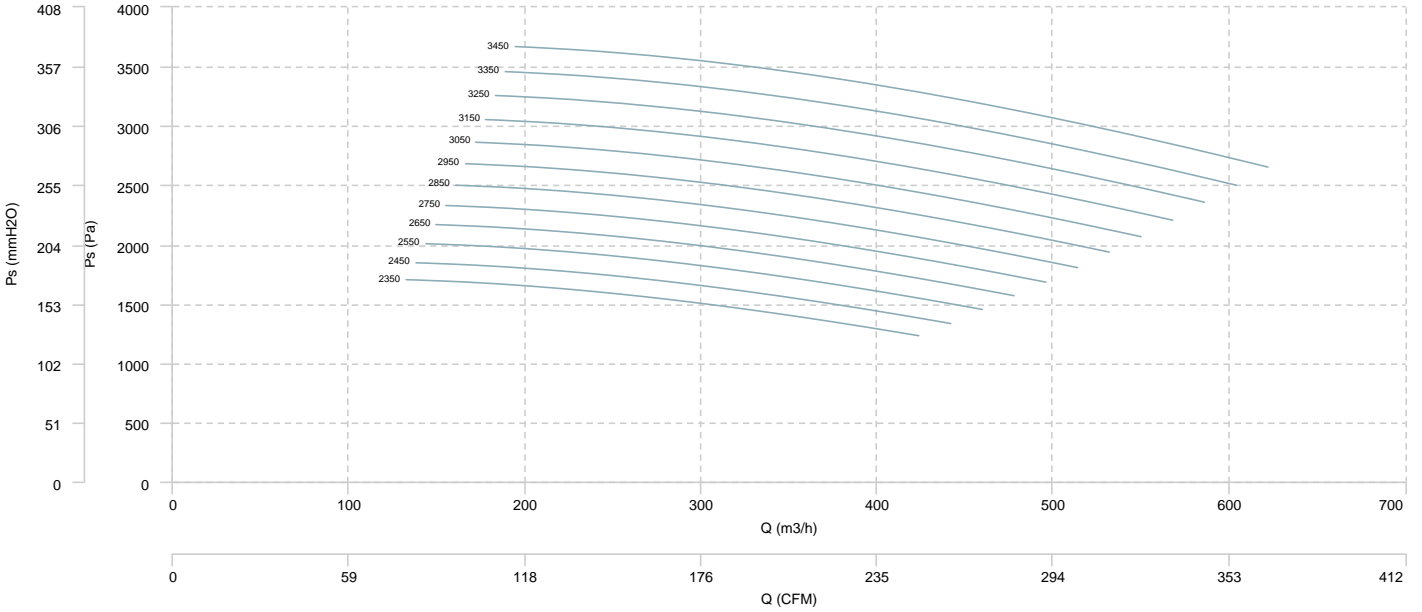

AIR FLOW - MECHANICAL POWER

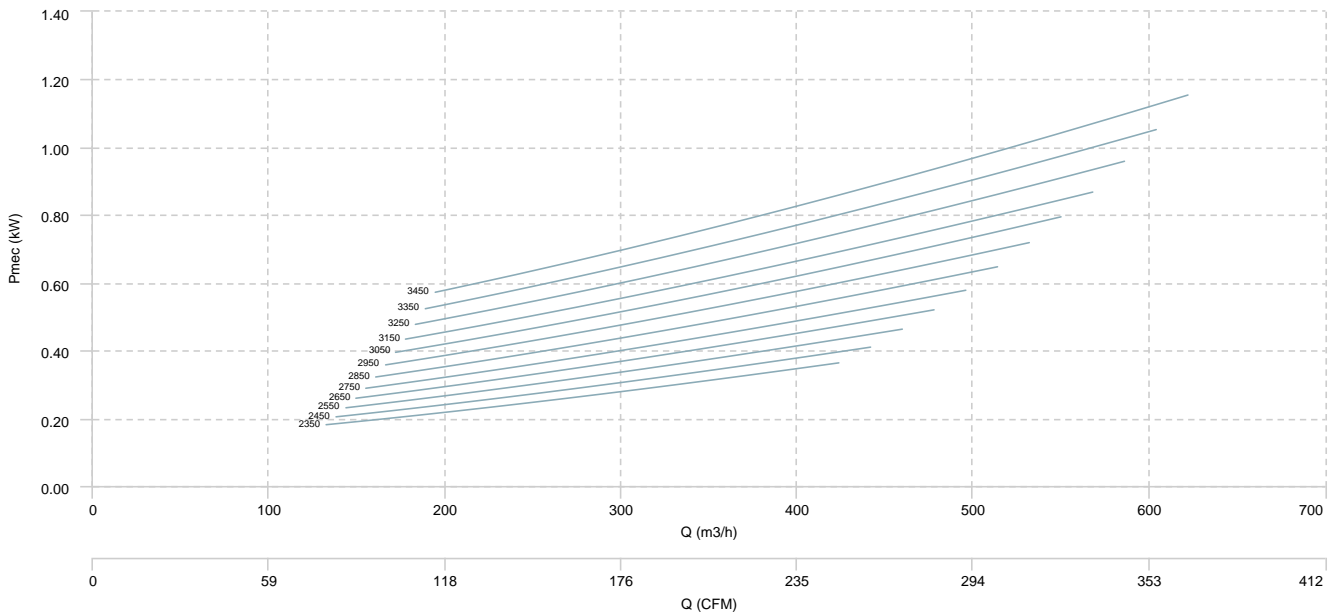

AATZA 450

AIR FLOW - PRESSURE

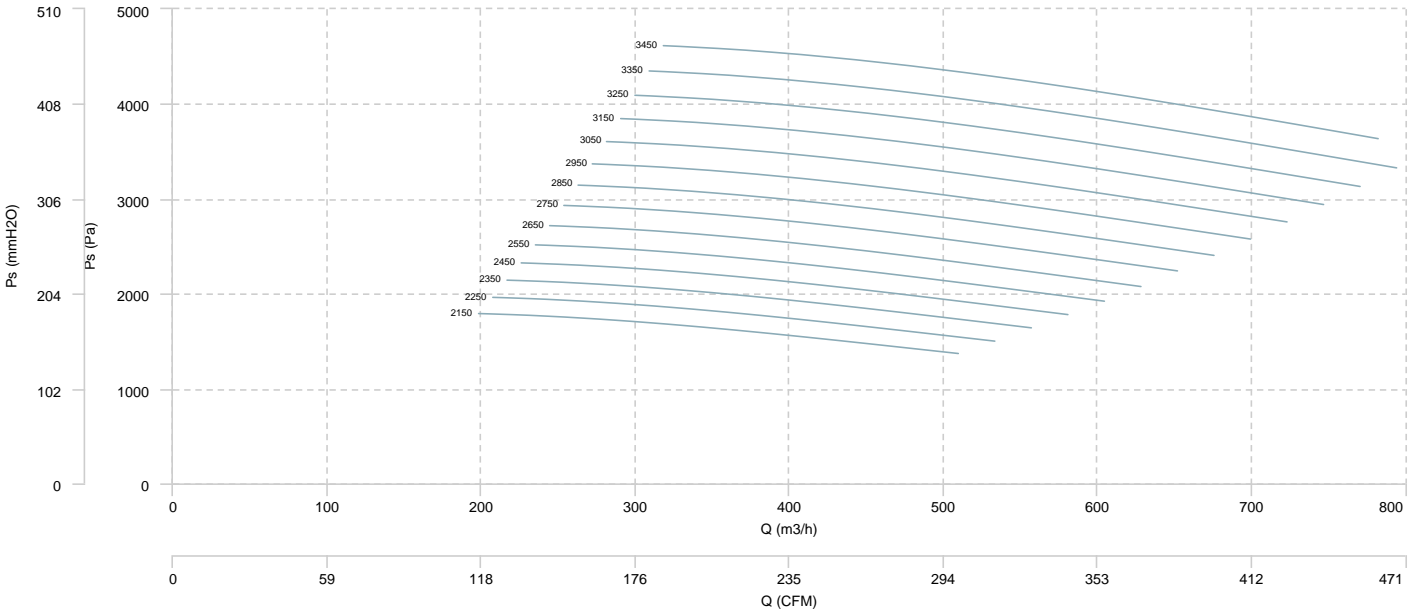

AIR FLOW - MECHANICAL POWER

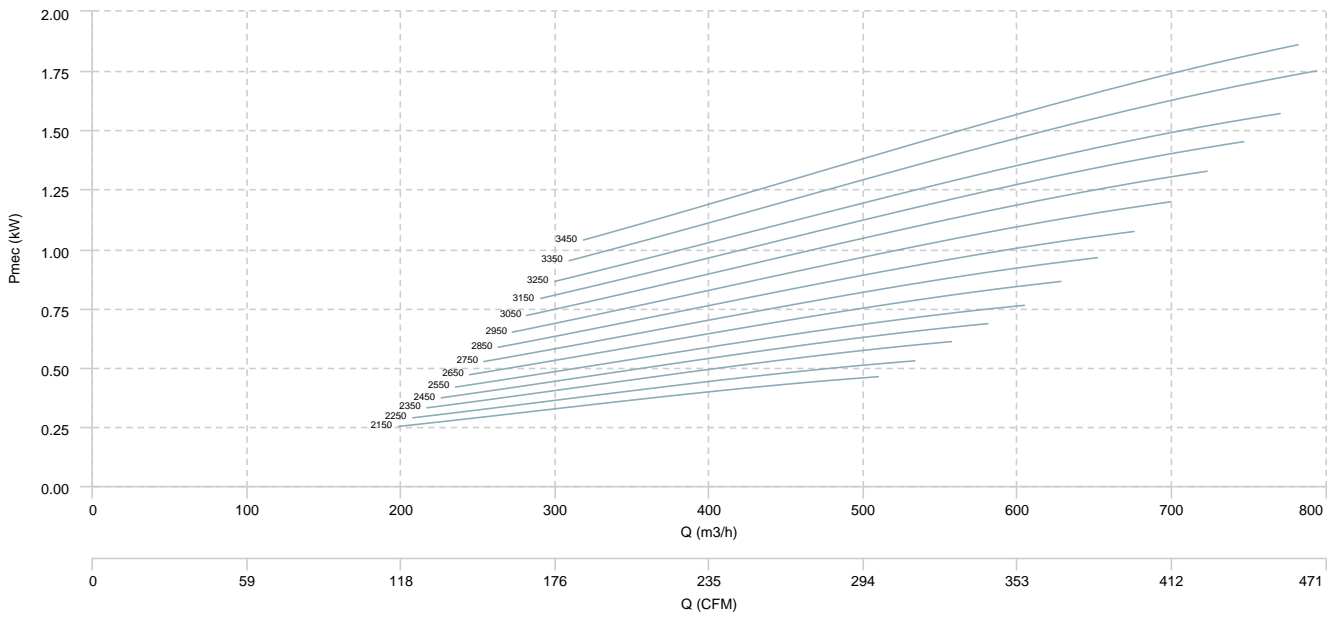

AATZA 500

AIR FLOW - PRESSURE

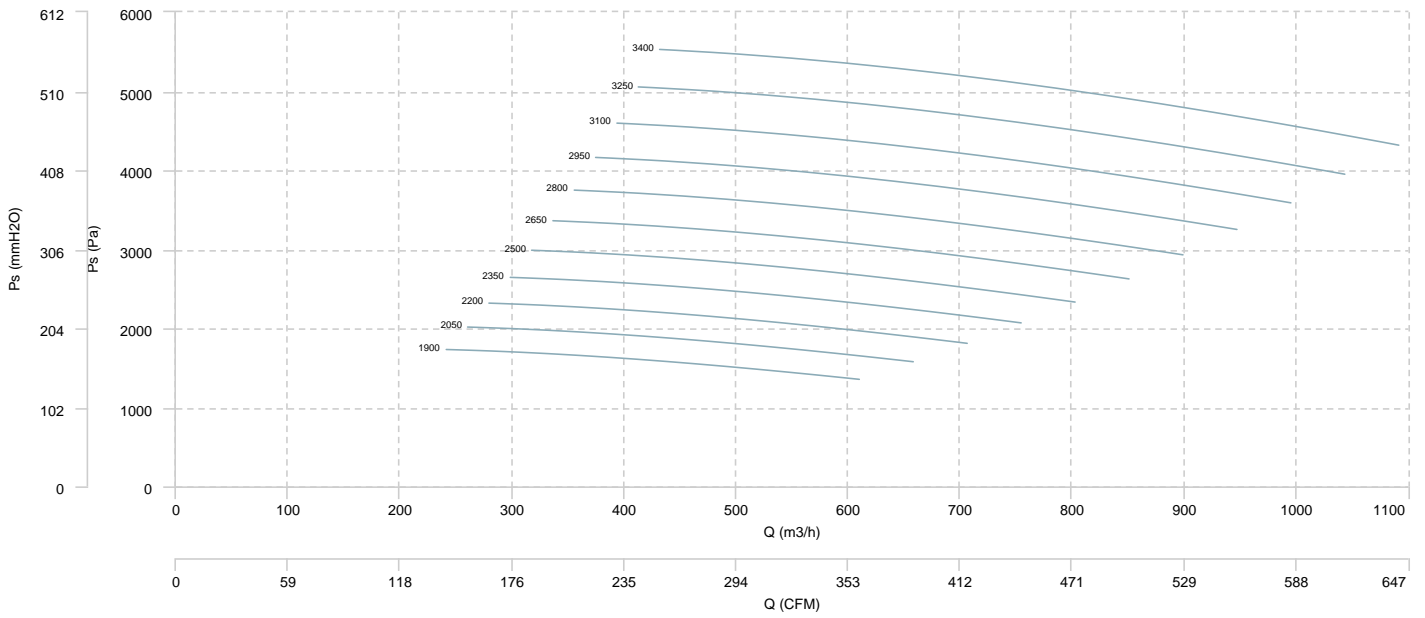

AIR FLOW - MECHANICAL POWER

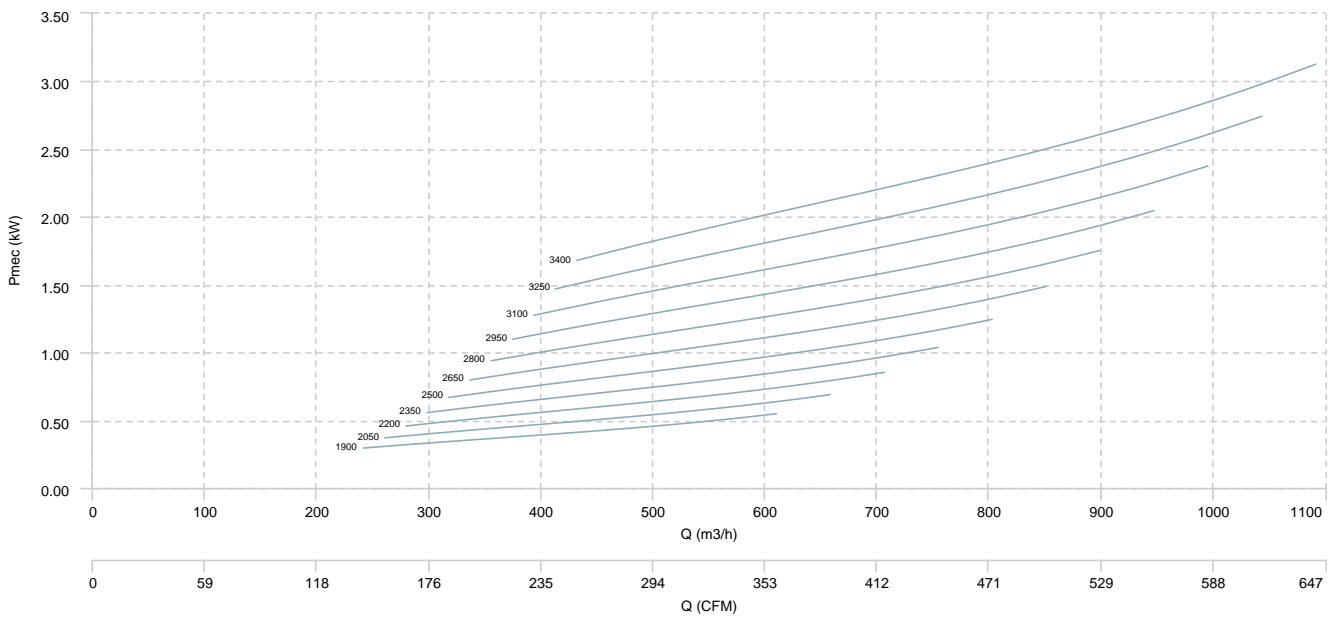

AATZA 560

AIR FLOW - PRESSURE

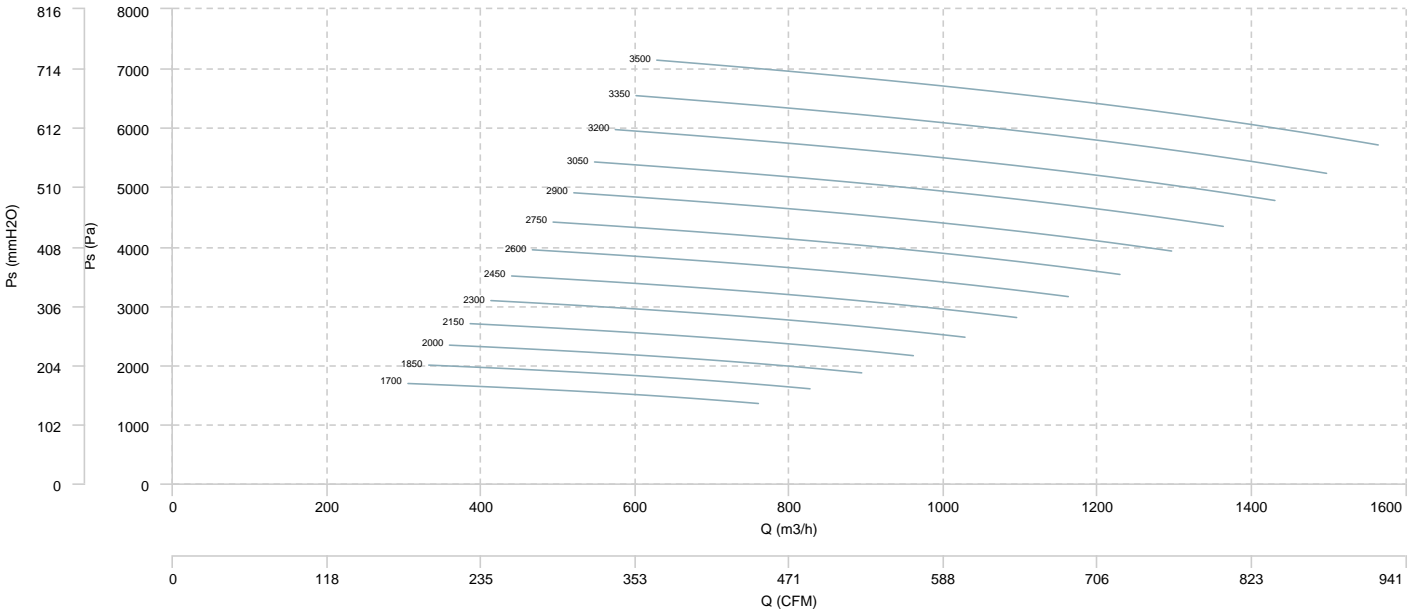

AIR FLOW - MECHANICAL POWER

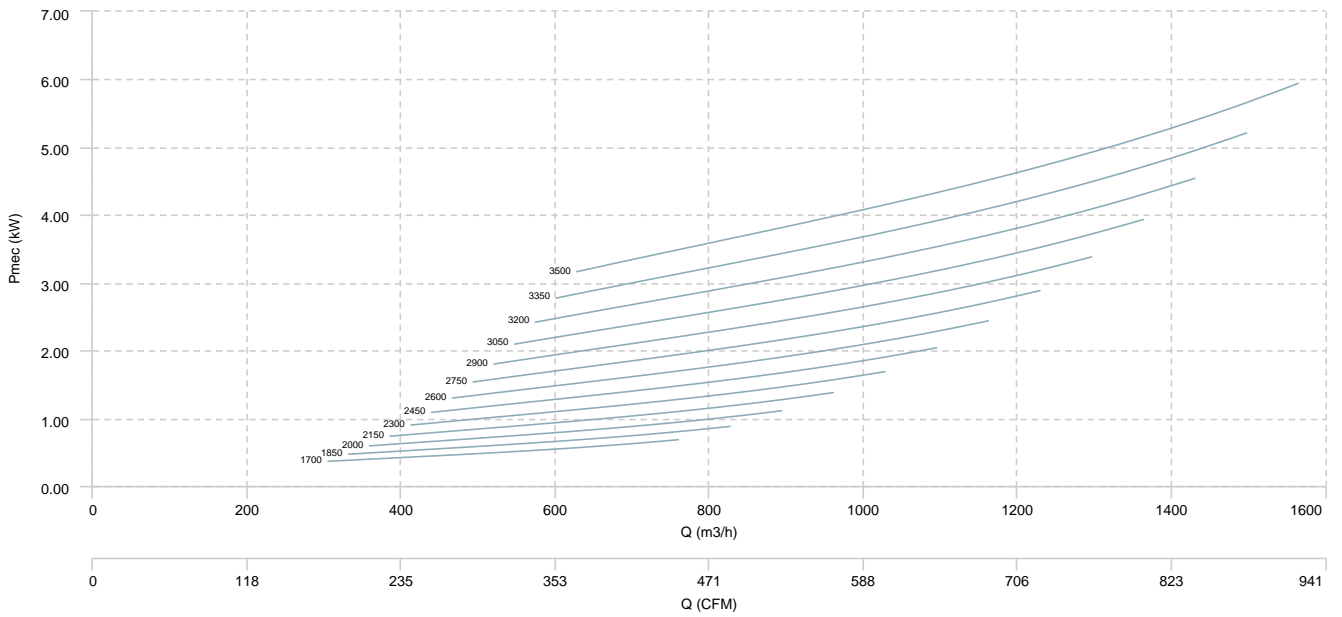

AATZA 630

AIR FLOW - PRESSURE

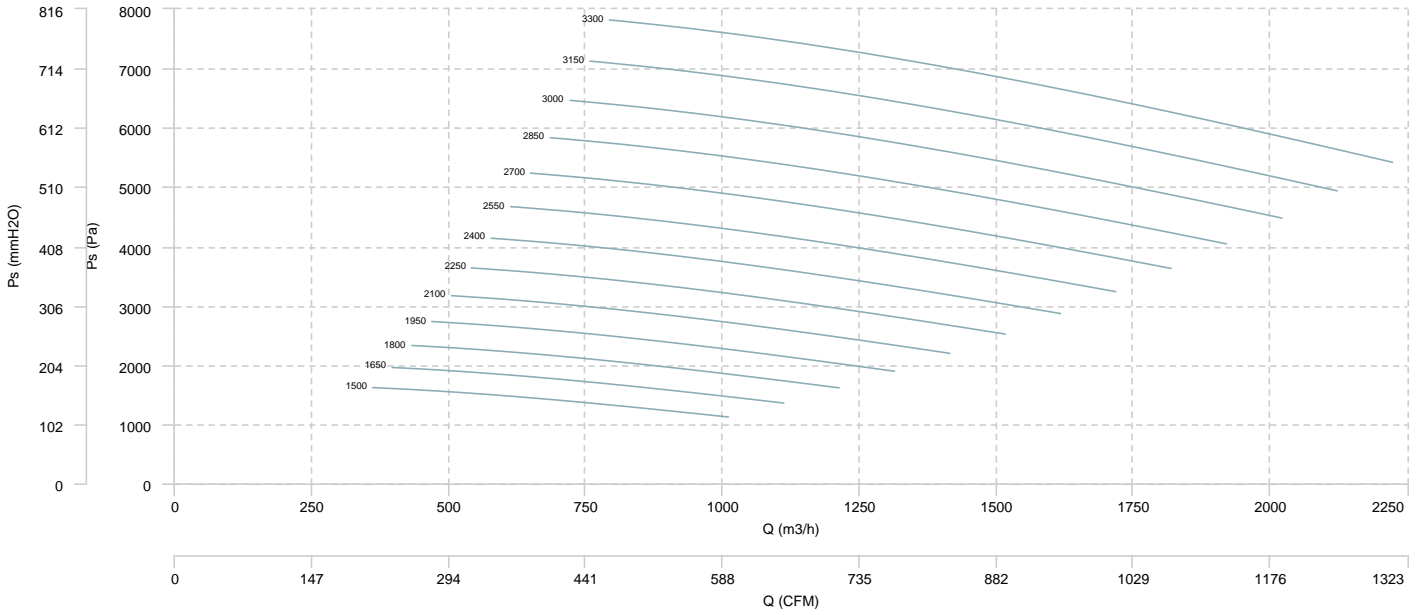

AIR FLOW - MECHANICAL POWER

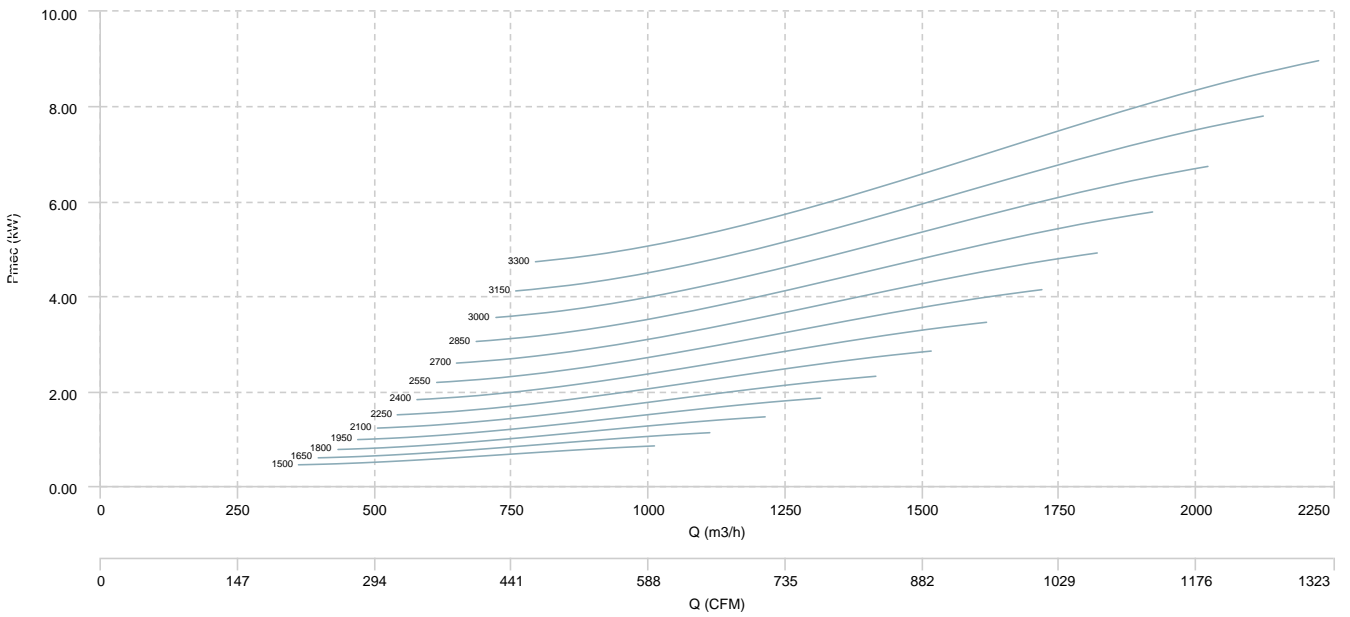

AATZA 710

AIR FLOW - PRESSURE

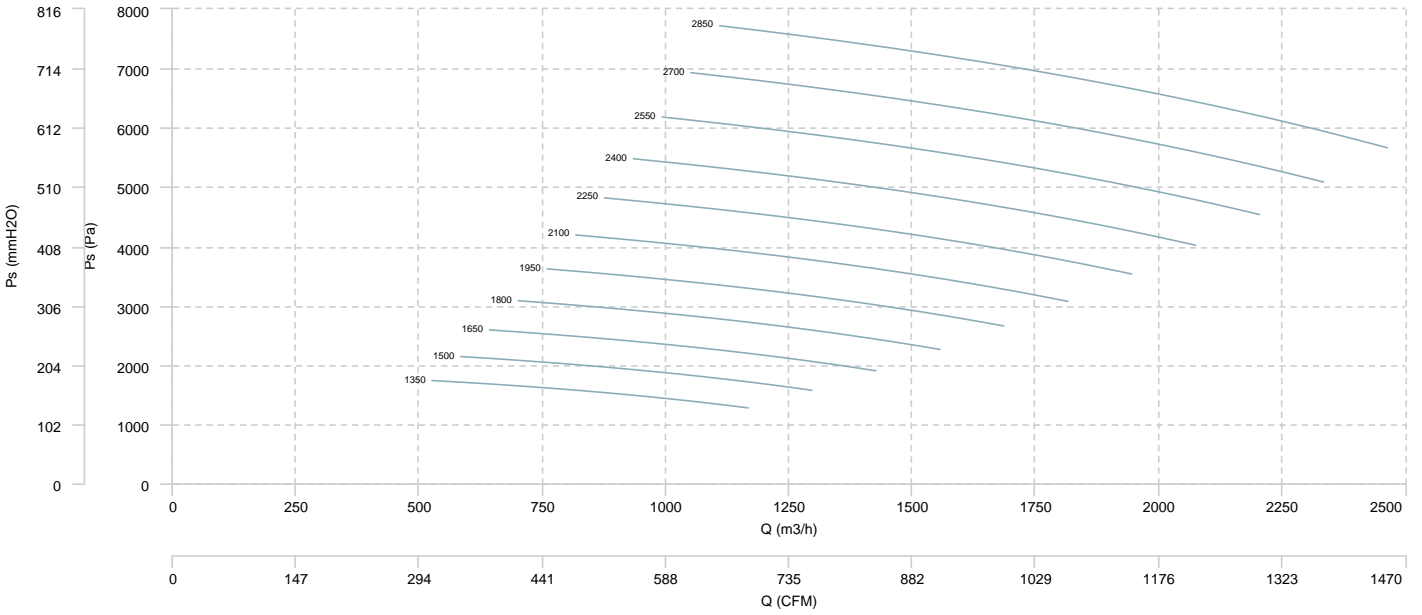

AIR FLOW - MECHANICAL POWER

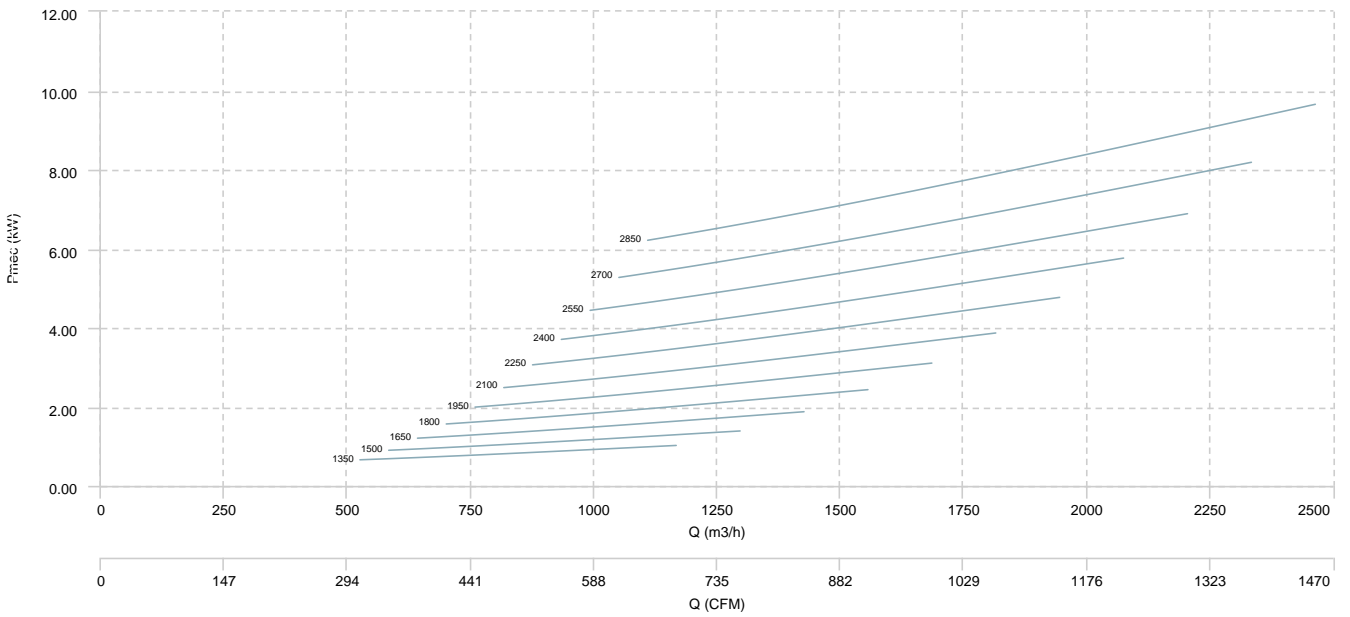

AATZA 800

AIR FLOW - PRESSURE

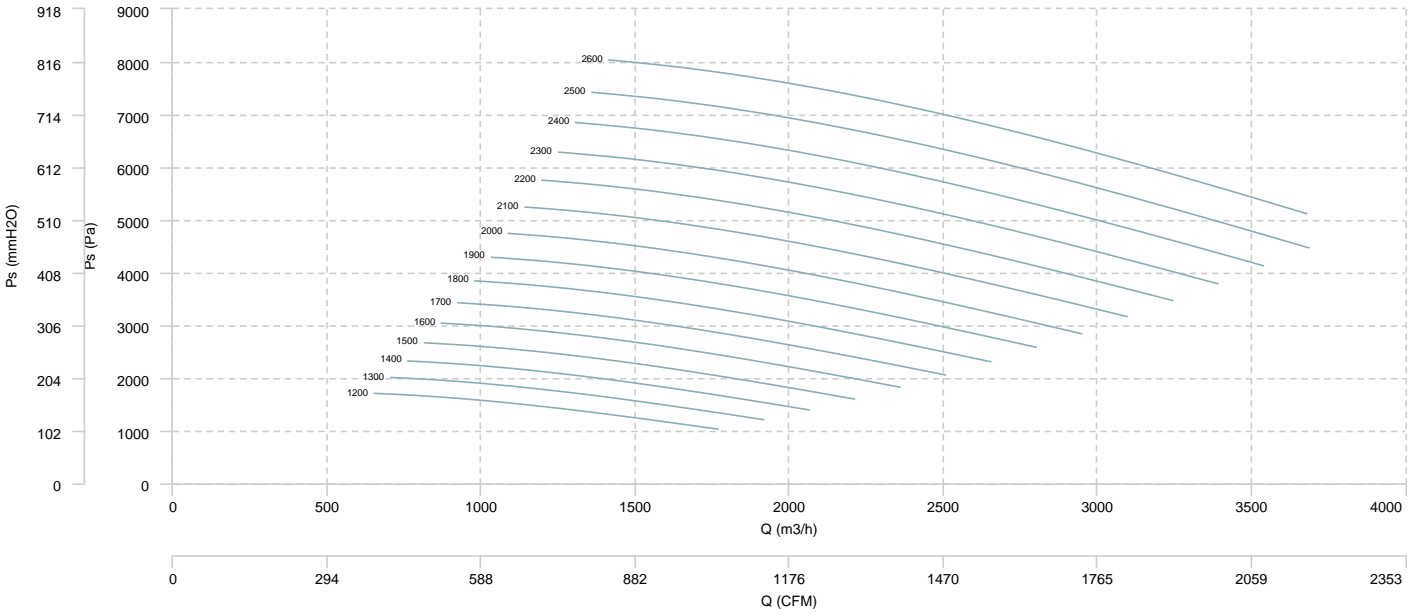

AIR FLOW - MECHANICAL POWER

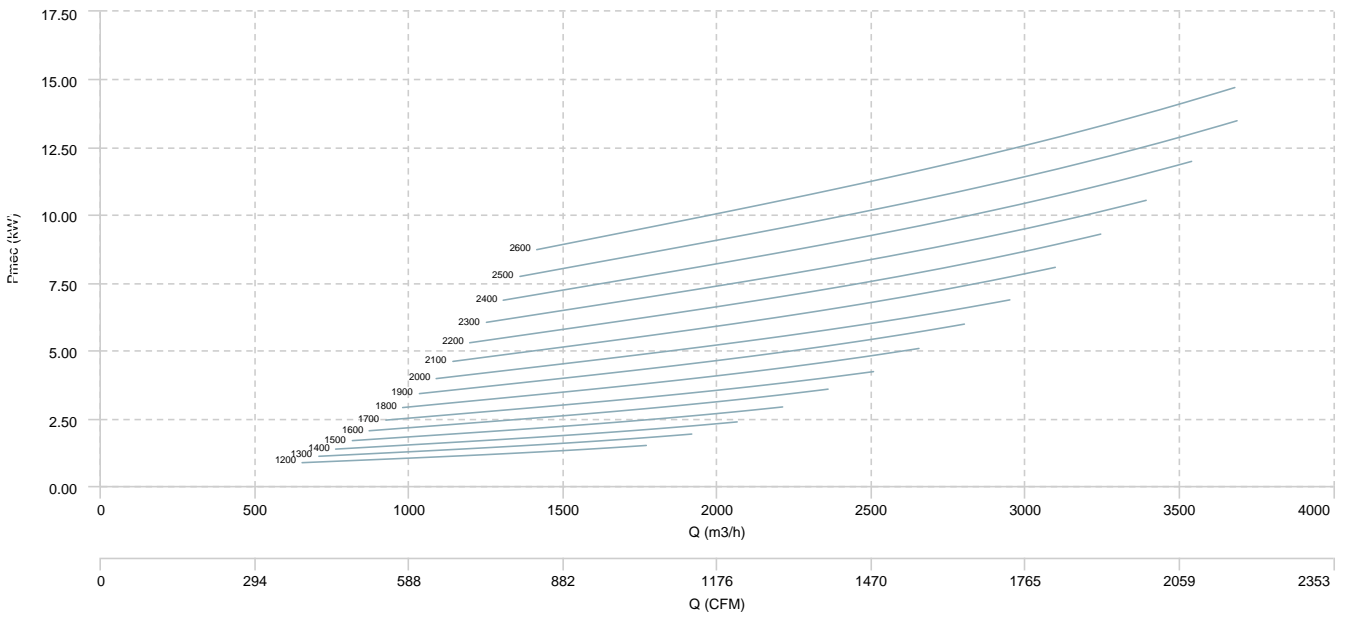

AATZA 900

AIR FLOW - PRESSURE

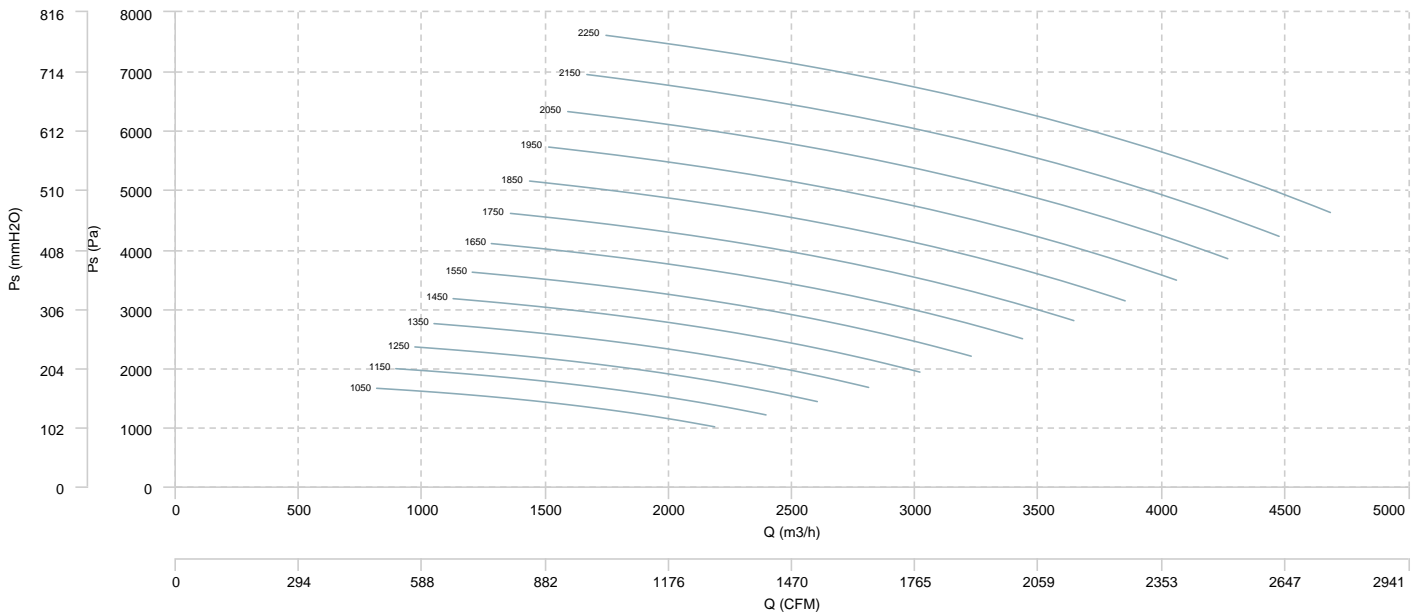

AIR FLOW - MECHANICAL POWER

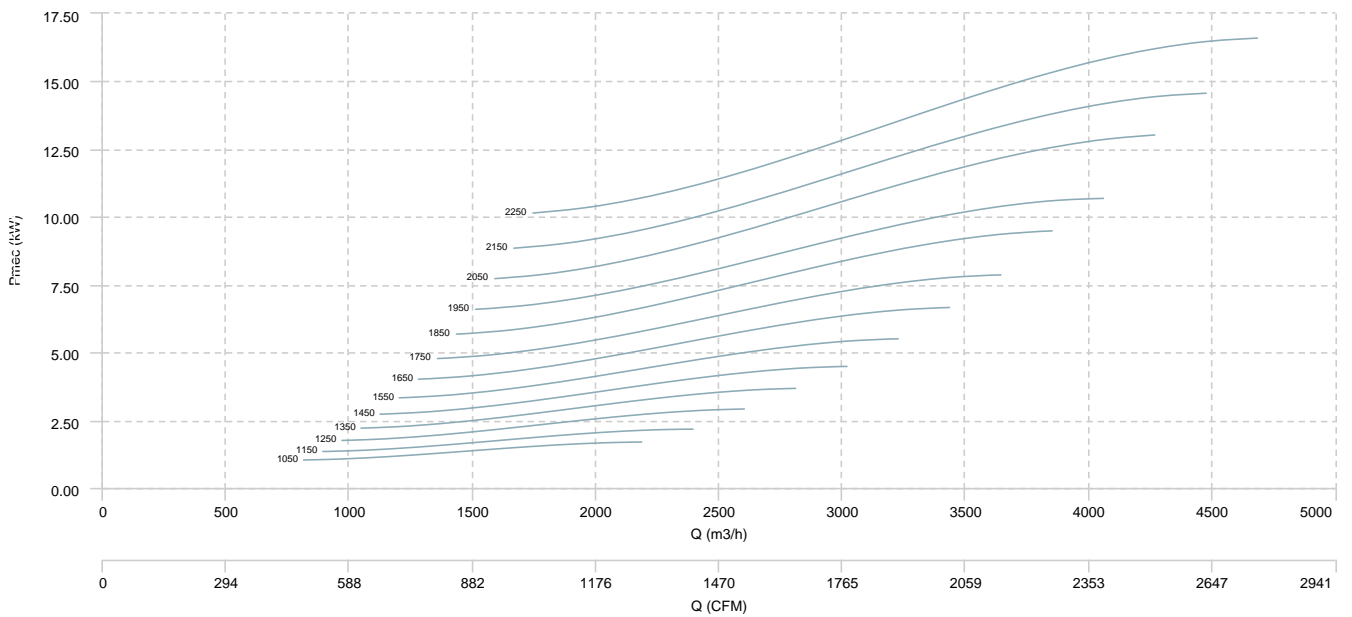

AATZA 1000

AIR FLOW - PRESSURE

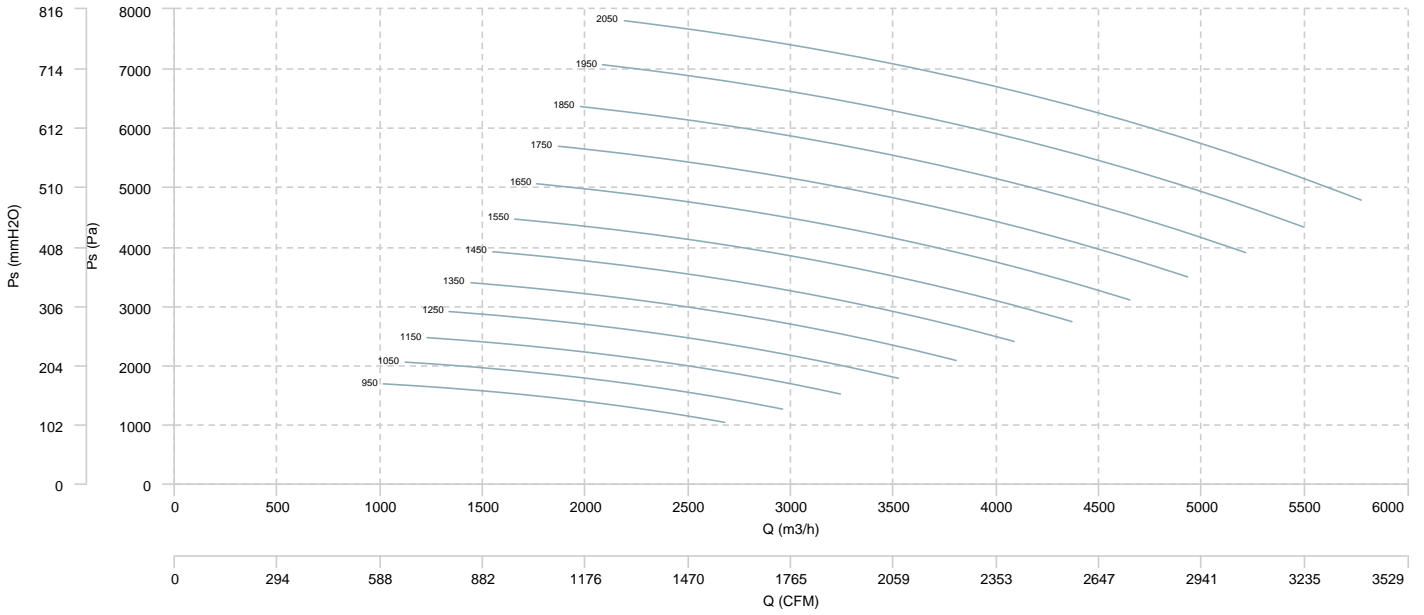

AIR FLOW - MECHANICAL POWER

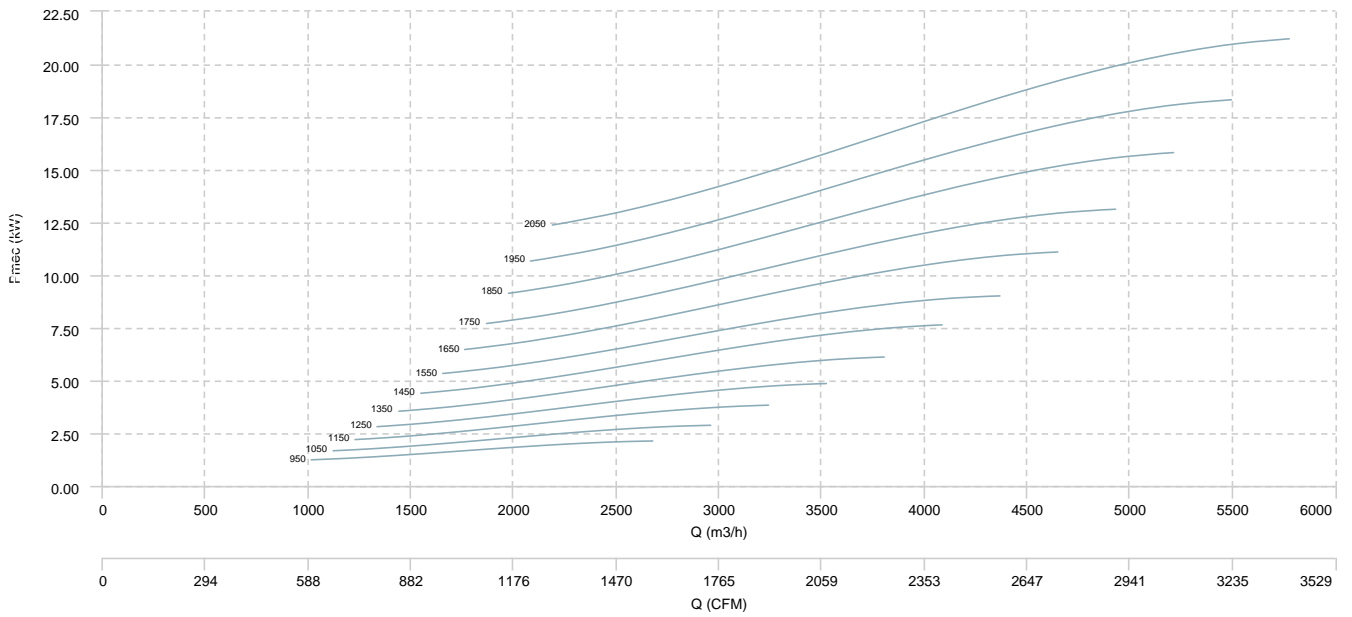

Sound data

Sound power Lw dB (A)										
Model		63 Hz	125 Hz	250 Hz	500 Hz	1000 Hz	2000 Hz	4000 Hz	8000 Hz	Total
AATZA 400 (2350 RPM)	Inlet	43	55	61	66	66	62	55	52	71
AATZA 450 (2150 RPM)	Inlet	45	57	64	68	69	64	57	54	73
AATZA 500 (1900 RPM)	Inlet	47	59	65	69	70	66	59	56	74
AATZA 560 (1700 RPM)	Inlet	49	61	67	72	72	68	61	58	77
AATZA 630 (1500 RPM)	Inlet	49	61	67	71	72	67	61	58	76
AATZA 710 (1350 RPM)	Inlet	50	62	68	72	73	68	62	59	77
AATZA 800 (1200 RPM)	Inlet	48	60	66	70	71	66	60	57	75
AATZA 900 (1050 RPM)	Inlet	49	61	67	71	72	68	61	58	77
AATZA 1000 (950 RPM)	Inlet	50	62	69	73	74	69	63	60	78

Notes:

* To calculate the sound power level at different rpm from those indicated above, use the following formula:

$$Lw \text{ dB(A)}_{rpmA} = Lw \text{ dB(A)}_{rpmB} + 52.5 \cdot \log_{10} \frac{rpmA}{rpmB}$$