

HC



SHORT CASE VARIABLE PITCH BLADES FAN

MANUFACTURING FEATURES:

- Plate axial fan with circular reinforced frame.
- Motor-impeller modular assembly for complete versatility.
- Polyester powder finishing coat.
- Standard asynchronous squirrel-cage motor with IP-55 protection and Class F insulation. Manufactured with standard voltages: 230V 50Hz in single phase motors and 230/400V 50Hz in three phase motors up to 4kW and 400/690V 50Hz for higher powers.
- HC: Polypropylene impeller (A2 profile) or polyamide impeller reinforced with fibreglass (other profiles) with variable pitch angle.
- HCA: Cast aluminum impeller with variable pitch angle.

APPLICATIONS:

Designed for wall or duct installation, they are suitable for:

- Air renewal in buildings and industries.
- Smoke exhaust (maximum 50-60°C).
- Maximum working temperature: 50°C single phase, 60°C three phase.

UNDER REQUEST:

- Supply impeller (air direction from impeller to motor), 100% reversible impeller.
- 60Hz fans and special voltages.
- Hot-dipped galvanized or stainless steel housing.
- Optional can be adapted an square plate to the frame, to transform it in an axial square frame version fan.

Accessories



AC



AVR



AVS



BA-400



BAD



INT



JE 45

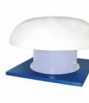

KIT TE



KIT TM



PO



RP



RP1



SFC



**SIL-C /
SIL-CN**

Technical data

Single-phase motor / 4 poles

Code	Model	Angle	Min. Rated power kW	Max. Rated power kW	Max. Airflow w m3/h	Sound db (A)**	Weight t	Connect. diagram
-	HC 35 M4 (A0:6)	35° - 40°	0,12	0,12	3.440	46	10	1
-	HC 40 M4 (A0:6)	35° - 40°	0,18	0,25	4.670	51	11,60	1
-	HC 45 M4 (A0:6)	35° - 40°	0,25	0,25	6.360	52	13,70	1
-	HC 45 M4 (A5:6)	25° - 45°	0,25	0,55	6.760	51	15,10	1
-	HC 50 M4 (A0:6)	35° - 40°	0,37	0,37	8.140	53	18,30	1
-	HC 50 M4 (A5:6)	25° - 45°	0,25	0,75	9.420	54	19,80	1
-	HC 56 M4 (A2:6)	20° - 45°	0,37	0,75	13.910	60	23,20	1
-	HC 56 M4 (A2:9)	20° - 45°	0,37	0,75	14.710	60	24,20	1
-	HC 56 M4 (A5:6)	20° - 45°	0,37	0,75	14.640	70	22,30	1
-	HC 63 M4 (A2:6)	20° - 30°	0,37	0,75	13.810	60	27,20	1
-	HC 63 M4 (A2:9)	20° - 27,5°	0,37	0,75	12.510	62	28,40	1
-	HC 63 M4 (A5:6)	20° - 25°	0,37	0,75	12.020	63	26,20	1
-	HC 71 M4 (A2:6)	20° - 25°	0,75	0,75	15.510	64	33,60	1
-	HC 71 M4 (A2:9)	20° - 20°	0,75	0,75	12.080	68	34,90	1
-	HC 71 M4 (A5:6)	20° - 20°	0,75	0,75	13.640	66	32,60	1

Single-phase motor / 6 poles

Code	Model	Angle	Min. Rated power kW	Max. Rated power kW	Max. Airflow w m3/h	Sound db (A)**	Weight t	Connect. diagram
-	HC 45 M6 (A0:6)	35° - 40°	0,12	0,12	4.120	42	13,70	1
-	HC 45 M6 (A5:6)	25° - 45°	0,18	0,18	4.380	42	15,10	1
-	HC 50 M6 (A0:6)	35° - 40°	0,12	0,12	5.270	44	18,30	1
-	HC 50 M6 (A5:6)	25° - 45°	0,18	0,18	6.100	45	19,80	1
-	HC 56 M6 (A2:6)	20° - 45°	0,12	0,55	9.000	51	23,20	1
-	HC 56 M6 (A2:9)	20° - 45°	0,12	0,55	9.520	51	24,20	1
-	HC 56 M6 (A5:6)	20° - 45°	0,18	0,55	9.760	67	22,30	1
-	HC 63 M6 (A2:6)	20° - 45°	0,37	0,75	13.010	53	27,20	1
-	HC 63 M6 (A2:9)	20° - 45°	0,37	0,75	14.110	53	28,40	1
-	HC 63 M6 (A5:6)	20° - 45°	0,37	0,75	13.570	71	26,20	1
-	HC 71 M6 (A2:6)	20° - 45°	0,37	0,75	18.110	56	33,60	1
-	HC 71 M6 (A2:9)	20° - 45°	0,37	0,75	19.610	58	34,90	1
-	HC 71 M6 (A5:6)	20° - 45°	0,37	0,75	18.350	76	32,60	1

Three-phase motor / 4 poles

Code	Model	Angle	Min. Rated power kW	Max. Rated power kW	Max. Airflow m ³ /h	Sound db (A)**	Weight t*	Connect. diagram
-	HC 35 T4 (A0:6)	35° - 40°	0,12	0,12	3.440	46	10	2
-	HC 40 T4 (A0:6)	35° - 40°	0,18	0,18	4.670	51	11,60	2
-	HC 45 T4 (A0:6)	35° - 40°	0,25	0,25	6.360	52	13,70	2
-	HC 45 T4 (A5:6)	25° - 45°	0,25	0,55	6.760	51	15,10	2
-	HC 50 T4 (A0:6)	35° - 40°	0,37	0,37	8.140	53	18,30	2
-	HC 50 T4 (A5:6)	25° - 45°	0,25	0,75	9.420	54	19,80	2
-	HC 56 T4 (A2:6)	20° - 45°	0,37	2,20	13.910	60	23,20	2
-	HC 56 T4 (A2:9)	20° - 45°	0,37	2,20	14.710	60	24,20	2
-	HC 56 T4 (A5:6)	20° - 45°	0,37	2,20	14.640	70	22,30	2
-	HC 63 T4 (A2:6)	20° - 45°	0,37	3	20.110	62	27,20	2
-	HC 63 T4 (A2:9)	20° - 45°	0,37	3	21.810	63	28,40	2
-	HC 63 T4 (A5:6)	20° - 45°	0,37	3	20.350	74	26,20	2
-	HC 71 T4 (A2:6)	20° - 45°	0,75	4	27.910	65	33,60	2
-	HC 71 T4 (A2:9)	20° - 45°	0,75	4	30.310	68	34,90	2
-	HC 71 T4 (A5:6)	20° - 45°	0,75	4	27.520	79	32,60	2
-	HC 80 T4 (A2:6)	20° - 45°	1,10	9,20	39.010	67	38,70	2
-	HC 80 T4 (A2:9)	20° - 45°	1,10	9,20	41.810	72	40,20	2
-	HC 80 T4 (A5:6)	20° - 40°	1,10	4	34.470	71	37,60	2
-	HC 90 T4 (A6:3)	20° - 42°	3	15	50.950	75	55,20	2
-	HC 90 T4 (A6:6)	20° - 42°	3	15	58.310	76	57,50	2
-	HC 100 T4 (A6:3)	20° - 42°	5,50	22	69.340	76	68,30	2
-	HC 100 T4 (A6:6)	20° - 42°	5,50	22	81.210	80	70,90	2
-	HC 112 T4 (A6:3)	20° - 42°	5,50	37	92.050	78	81,50	2
-	HC 112 T4 (A6:6)	20° - 42°	5,50	37	109.010	83	84,40	2
-	HC 125 T4 (A7:4)	20° - 42°	7,50	45	132.010	85	95,70	2
-	HC 125 T4 (A7:8)	20° - 42°	11	45	151.010	89	99,70	2

Three-phase motor / 6 poles

Code	Model	Angle	Min. Rated power kW	Max. Rated power kW	Max. Airflow m ³ /h	Sound db (A)**	Weight t*	Connect. diagram
-	HC 35 T6 (A0:6)	35° - 40°	0,12	0,12	2.230	37	10	2
-	HC 40 T6 (A0:6)	35° - 40°	0,12	0,12	3.030	42	11,60	2
-	HC 45 T6 (A0:6)	35° - 40°	0,12	0,12	4.120	42	13,70	2

Code	Model	Angle	Min. Rated power kW	Max. Rated power kW	Max. Airflow w m3/h	Sound db (A)**	Weigh t*	Connect. diagram
-	HC 45 T6 (A5:6)	25° - 45°	0,18	0,18	4.380	42	15,10	2
-	HC 50 T6 (A0:6)	35° - 40°	0,12	0,12	5.270	44	18,30	2
-	HC 50 T6 (A5:6)	25° - 45°	0,18	0,18	6.100	45	19,80	2
-	HC 56 T6 (A2:6)	20° - 45°	0,12	0,55	9.000	51	23,20	2
-	HC 56 T6 (A2:9)	20° - 45°	0,12	0,55	9.520	51	24,20	2
-	HC 56 T6 (A5:6)	20° - 45°	0,18	0,55	9.760	67	22,30	2
-	HC 63 T6 (A2:6)	20° - 45°	0,37	0,75	13.010	53	27,20	2
-	HC 63 T6 (A2:9)	20° - 45°	0,37	0,75	14.110	53	28,40	2
-	HC 63 T6 (A5:6)	20° - 45°	0,37	0,75	13.570	71	26,20	2
-	HC 71 T6 (A2:6)	20° - 45°	0,37	1,10	18.110	56	33,60	2
-	HC 71 T6 (A2:9)	20° - 45°	0,37	1,10	19.610	58	34,90	2
-	HC 71 T6 (A5:6)	20° - 45°	0,37	1,10	18.350	76	32,60	2
-	HC 80 T6 (A2:6)	20° - 45°	0,75	2,20	25.310	57	38,70	2
-	HC 80 T6 (A2:9)	20° - 45°	0,75	2,20	27.110	63	40,20	2
-	HC 80 T6 (A5:6)	20° - 45°	0,75	2,20	25.190	72	37,60	2
-	HC 90 T6 (A6:3)	20° - 42°	0,75	4	33.010	65	55,20	2
-	HC 90 T6 (A6:6)	20° - 42°	0,75	4	37.810	66	57,50	2
-	HC 100 T6 (A6:3)	20° - 42°	1,10	7,50	44.970	66	68,30	2
-	HC 100 T6 (A6:6)	20° - 42°	1,10	7,50	52.610	70	70,90	2
-	HC 112 T6 (A6:3)	20° - 42°	1,50	11	59.660	69	81,50	2
-	HC 112 T6 (A6:6)	20° - 42°	1,50	11	70.510	73	84,40	2
-	HC 125 T6 (A7:4)	20° - 42°	2,20	15	85.410	76	95,70	2
-	HC 125 T6 (A7:8)	20° - 42°	3	15	98.110	80	99,70	2

2 SPEED MOTOR / 4/8 poles

Code	Model	Angle	Min. Rated power kW	Max. Rated power kW	Max. Airflow w m3/h	Sound db (A)**	Weigh t*	Connect. diagram
-	HC 35 T4/T8 (A0:6)	35° - 40°	0,25	0,25	3.440	46	10	3
-	HC 40 T4/T8 (A0:6)	35° - 40°	0,25	0,25	4.670	51	11,60	3
-	HC 45 T4/T8 (A0:6)	35° - 40°	0,25	0,25	6.360	52	13,70	3
-	HC 45 T4/T8 (A5:6)	25° - 45°	0,25	0,55	6.760	51	15,10	3
-	HC 50 T4/T8 (A0:6)	35° - 40°	0,33	0,33	8.140	53	18,30	3
-	HC 50 T4/T8 (A5:6)	25° - 45°	0,25	0,75	9.420	54	19,80	3
-	HC 56 T4/T8 (A2:6)	20° - 45°	0,33	2,20	13.910	60	23,20	3
-	HC 56 T4/T8 (A2:9)	20° - 45°	0,33	2,20	14.710	60	24,20	3
-	HC 56 T4/T8 (A5:6)	20° - 45°	0,33	2,20	14.640	70	22,30	3

Code	Model	Angle	Min. Rated power kW	Max. Rated power kW	Max. Airflow m ³ /h	Sound db (A)**	Weight t*	Connect. diagram
-	HC 63 T4/T8 (A2:6)	20° - 45°	0,33	3	20.110	62	27,20	3
-	HC 63 T4/T8 (A2:9)	20° - 45°	0,33	3	21.810	63	28,40	3
-	HC 63 T4/T8 (A5:6)	20° - 45°	0,33	3	20.350	74	26,20	3
-	HC 71 T4/T8 (A2:6)	20° - 45°	0,75	4	27.910	65	33,60	3
-	HC 71 T4/T8 (A2:9)	20° - 45°	0,75	4	30.310	68	34,90	3
-	HC 71 T4/T8 (A5:6)	20° - 45°	0,75	4	27.520	79	32,60	3
-	HC 80 T4/T8 (A2:6)	20° - 45°	1,10	7,50	39.010	67	38,70	3
-	HC 80 T4/T8 (A2:9)	20° - 45°	1,10	7,50	41.810	72	40,20	3
-	HC 80 T4/T8 (A5:6)	20° - 45°	1,10	4	37.780	76	37,60	3
-	HC 90 T4/T8 (A6:3)	20° - 42°	3	15	50.950	75	55,20	3
-	HC 90 T4/T8 (A6:6)	20° - 42°	3	15	58.310	76	57,50	3
-	HC 100 T4/T8 (A6:3)	20° - 42°	5,50	20	69.340	76	68,30	3
-	HC 100 T4/T8 (A6:6)	20° - 42°	5,50	20	81.210	80	70,90	3
-	HC 112 T4/T8 (A6:3)	20° - 42°	5,50	37	92.050	78	81,50	3
-	HC 112 T4/T8 (A6:6)	20° - 42°	5,50	37	109.010	83	84,40	3
-	HC 125 T4/T8 (A7:4)	20° - 42°	7,50	44	132.010	85	95,70	3
-	HC 125 T4/T8 (A7:8)	20° - 42°	11	44	151.010	89	99,70	3

Notes:

* The motor is not included in fan weight

** Total sound pressure level at the point of maximum flow measured in dB(A) in the suction measured in free field at a distance of 6m from the source

Dimensions

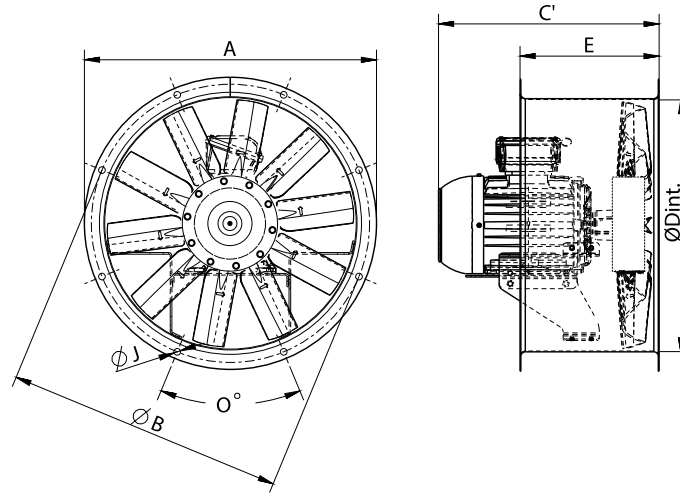

Model	C' (Mot. T.63)	C' (Mot. T.71)	C' (Mot. T.80)	C' (Mot. T.90L)	C' (Mot. T.90S)	C' (Mot. T.100L)	C' (Mot. T.112)	C' (Mot. T.112M)	C' (Mot. T.132)
HC 35 M4 (A0:6)	308	311	340	-	-	-	-	-	-
HC 35 T4 (A0:6)	308	311	340	-	-	-	-	-	-
HC 35 T6 (A0:6)	308	311	340	-	-	-	-	-	-
HC 35 T4/T8 (A0:6)	308	311	340	-	-	-	-	-	-
HC 40 M4 (A0:6)	308	311	345	387	361.5	-	-	-	-
HC 40 T4 (A0:6)	308	311	345	387	361.5	-	-	-	-
HC 40 T6 (A0:6)	308	311	345	387	361.5	-	-	-	-
HC 40 T4/T8 (A0:6)	308	311	345	387	361.5	-	-	-	-
HC 45 M4 (A0:6)	338	348	357	397	372	428	-	-	-
HC 45 M4 (A5:6)	338	348	357	397	372	428	-	-	-
HC 45 M6 (A0:6)	338	348	357	397	372	428	-	-	-
HC 45 M6 (A5:6)	338	348	357	397	372	428	-	-	-
HC 45 T4 (A0:6)	338	348	357	397	372	428	-	-	-
HC 45 T4 (A5:6)	338	348	357	397	372	428	-	-	-
HC 45 T6 (A0:6)	338	348	357	397	372	428	-	-	-
HC 45 T6 (A5:6)	338	348	357	397	372	428	-	-	-
HC 45 T4/T8 (A0:6)	338	348	357	397	372	428	-	-	-
HC 45 T4/T8 (A5:6)	338	348	357	397	372	428	-	-	-
HC 50 M4 (A0:6)	-	348	360	397	372	428	-	-	-
HC 50 M4 (A5:6)	-	348	360	397	372	428	-	-	-
HC 50 M6 (A0:6)	-	348	360	397	372	428	-	-	-
HC 50 M6 (A5:6)	-	348	360	397	372	428	-	-	-
HC 50 T4 (A0:6)	-	348	360	397	372	428	-	-	-
HC 50 T4 (A5:6)	-	348	360	397	372	428	-	-	-

Model	C' (Mot. T.63)	C' (Mot. T.71)	C' (Mot. T.80)	C' (Mot. T.90L)	C' (Mot. T.90S)	C' (Mot. T.100L)	C' (Mot. T.112)	C' (Mot. T.112M)	C' (Mot. T.132)
HC 50 T6 (A0:6)	-	348	360	397	372	428	-	-	-
HC 50 T6 (A5:6)	-	348	360	397	372	428	-	-	-
HC 50 T4/T8 (A0:6)	-	348	360	397	372	428	-	-	-
HC 50 T4/T8 (A5:6)	-	348	360	397	372	428	-	-	-
HC 56 M4 (A2:6)	-	348	362	397	372	433	-	-	-
HC 56 M4 (A2:9)	-	348	362	397	372	433	-	-	-
HC 56 M4 (A5:6)	-	348	362	397	372	433	-	-	-
HC 56 M6 (A2:6)	-	348	362	397	372	433	-	-	-
HC 56 M6 (A2:9)	-	348	362	397	372	433	-	-	-
HC 56 M6 (A5:6)	-	348	362	397	372	433	-	-	-
HC 56 T4 (A2:6)	-	348	362	397	372	433	-	-	-
HC 56 T4 (A2:9)	-	348	362	397	372	433	-	-	-
HC 56 T4 (A5:6)	-	348	362	397	372	433	-	-	-
HC 56 T6 (A2:6)	-	348	362	397	372	433	-	-	-
HC 56 T6 (A2:9)	-	348	362	397	372	433	-	-	-
HC 56 T6 (A5:6)	-	348	362	397	372	433	-	-	-
HC 56 T4/T8 (A2:6)	-	348	362	397	372	433	-	-	-
HC 56 T4/T8 (A2:9)	-	348	362	397	372	433	-	-	-
HC 56 T4/T8 (A5:6)	-	348	362	397	372	433	-	-	-
HC 63 M4 (A2:6)	-	-	359	398	393	450	-	471	-
HC 63 M4 (A2:9)	-	-	359	398	393	450	-	471	-
HC 63 M4 (A5:6)	-	-	359	398	393	450	-	471	-
HC 63 M6 (A2:6)	-	-	359	398	393	450	-	471	-
HC 63 M6 (A2:9)	-	-	359	398	393	450	-	471	-
HC 63 M6 (A5:6)	-	-	359	398	393	450	-	471	-
HC 63 T4 (A2:6)	-	-	359	398	393	450	-	471	-
HC 63 T4 (A2:9)	-	-	359	398	393	450	-	471	-
HC 63 T4 (A5:6)	-	-	359	398	393	450	-	471	-
HC 63 T6 (A2:6)	-	-	359	398	393	450	-	471	-
HC 63 T6 (A2:9)	-	-	359	398	393	450	-	471	-
HC 63 T6 (A5:6)	-	-	359	398	393	450	-	471	-
HC 63 T4/T8 (A2:6)	-	-	359	398	393	450	-	471	-
HC 63 T4/T8 (A2:9)	-	-	359	398	393	450	-	471	-
HC 63 T4/T8 (A5:6)	-	-	359	398	393	450	-	471	-
HC 71 M4 (A2:6)	-	-	362	421	396	452	-	473	-
HC 71 M4 (A2:9)	-	-	362	421	396	452	-	473	-
HC 71 M4 (A5:6)	-	-	362	421	396	452	-	473	-
HC 71 M6 (A2:6)	-	-	362	421	396	452	-	473	-
HC 71 M6 (A2:9)	-	-	362	421	396	452	-	473	-
HC 71 M6 (A5:6)	-	-	362	421	396	452	-	473	-

Model	C' (Mot. T.63)	C' (Mot. T.71)	C' (Mot. T.80)	C' (Mot. T.90L)	C' (Mot. T.90S)	C' (Mot. T.100L)	C' (Mot. T.112)	C' (Mot. T.112M)	C' (Mot. T.132)
HC 71 T4 (A2:6)	-	-	362	421	396	452	-	473	-
HC 71 T4 (A2:9)	-	-	362	421	396	452	-	473	-
HC 71 T4 (A5:6)	-	-	362	421	396	452	-	473	-
HC 71 T6 (A2:6)	-	-	362	421	396	452	-	473	-
HC 71 T6 (A2:9)	-	-	362	421	396	452	-	473	-
HC 71 T6 (A5:6)	-	-	362	421	396	452	-	473	-
HC 71 T4/T8 (A2:6)	-	-	362	421	396	452	-	473	-
HC 71 T4/T8 (A2:9)	-	-	362	421	396	452	-	473	-
HC 71 T4/T8 (A5:6)	-	-	362	421	396	452	-	473	-
HC 80 T4 (A2:6)	-	-	-	445	445	476	-	477	-
HC 80 T4 (A2:9)	-	-	-	445	445	476	-	477	-
HC 80 T4 (A5:6)	-	-	-	445	445	476	-	477	-
HC 80 T6 (A2:6)	-	-	-	445	445	476	-	477	-
HC 80 T6 (A2:9)	-	-	-	445	445	476	-	477	-
HC 80 T6 (A5:6)	-	-	-	445	445	476	-	477	-
HC 80 T4/T8 (A2:6)	-	-	-	445	445	476	-	477	-
HC 80 T4/T8 (A2:9)	-	-	-	445	445	476	-	477	-
HC 80 T4/T8 (A5:6)	-	-	-	445	445	476	-	477	-
HC 90 T4 (A6:3)	-	-	-	-	-	655	655	-	655
HC 90 T4 (A6:6)	-	-	-	-	-	655	655	-	655
HC 90 T6 (A6:3)	-	-	-	-	-	655	655	-	655
HC 90 T6 (A6:6)	-	-	-	-	-	655	655	-	655
HC 90 T4/T8 (A6:3)	-	-	-	-	-	655	655	-	655
HC 90 T4/T8 (A6:6)	-	-	-	-	-	655	655	-	655
HC 100 T4 (A6:3)	-	-	-	-	-	-	-	-	655
HC 100 T4 (A6:6)	-	-	-	-	-	-	-	-	655
HC 100 T6 (A6:3)	-	-	-	-	-	-	-	-	655
HC 100 T6 (A6:6)	-	-	-	-	-	-	-	-	655
HC 100 T4/T8 (A6:3)	-	-	-	-	-	-	-	-	655
HC 100 T4/T8 (A6:6)	-	-	-	-	-	-	-	-	655
HC 112 T4 (A6:3)	-	-	-	-	-	-	-	-	765
HC 112 T4 (A6:6)	-	-	-	-	-	-	-	-	765
HC 112 T6 (A6:3)	-	-	-	-	-	-	-	-	765
HC 112 T6 (A6:6)	-	-	-	-	-	-	-	-	765
HC 112 T4/T8 (A6:3)	-	-	-	-	-	-	-	-	765
HC 112 T4/T8 (A6:6)	-	-	-	-	-	-	-	-	765
HC 125 T4 (A7:4)	-	-	-	-	-	-	-	-	765
HC 125 T4 (A7:8)	-	-	-	-	-	-	-	-	765
HC 125 T6 (A7:4)	-	-	-	-	-	-	-	-	765
HC 125 T6 (A7:8)	-	-	-	-	-	-	-	-	765

Model	C' (Mot. T.63)	C' (Mot. T.71)	C' (Mot. T.80)	C' (Mot. T.90L)	C' (Mot. T.90S)	C' (Mot. T.100L)	C' (Mot. T.112)	C' (Mot. T.112M)	C' (Mot. T.132)
HC 125 T4/T8 (A7:4)	-	-	-	-	-	-	-	-	765
HC 125 T4/T8 (A7:8)	-	-	-	-	-	-	-	-	765

Model	C' (Mot. T.132M)	C' (Mot. T.132S)	C' (Mot. T.160L)	C' (Mot. T.160M)	C' (Mot. T.180L)	C' (Mot. T.180M)	C' (Mot. T.200)	C' (Mot. T.225)	E
HC 35 M4 (A0:6)	-	-	-	-	-	-	-	-	250
HC 35 T4 (A0:6)	-	-	-	-	-	-	-	-	250
HC 35 T6 (A0:6)	-	-	-	-	-	-	-	-	250
HC 35 T4/T8 (A0:6)	-	-	-	-	-	-	-	-	250
HC 40 M4 (A0:6)	-	-	-	-	-	-	-	-	250
HC 40 T4 (A0:6)	-	-	-	-	-	-	-	-	250
HC 40 T6 (A0:6)	-	-	-	-	-	-	-	-	250
HC 40 T4/T8 (A0:6)	-	-	-	-	-	-	-	-	250
HC 45 M4 (A0:6)	-	-	-	-	-	-	-	-	250
HC 45 M4 (A5:6)	-	-	-	-	-	-	-	-	250
HC 45 M6 (A0:6)	-	-	-	-	-	-	-	-	250
HC 45 M6 (A5:6)	-	-	-	-	-	-	-	-	250
HC 45 T4 (A0:6)	-	-	-	-	-	-	-	-	250
HC 45 T4 (A5:6)	-	-	-	-	-	-	-	-	250
HC 45 T6 (A0:6)	-	-	-	-	-	-	-	-	250
HC 45 T6 (A5:6)	-	-	-	-	-	-	-	-	250
HC 45 T4/T8 (A0:6)	-	-	-	-	-	-	-	-	250
HC 45 T4/T8 (A5:6)	-	-	-	-	-	-	-	-	250
HC 50 M4 (A0:6)	-	-	-	-	-	-	-	-	250
HC 50 M4 (A5:6)	-	-	-	-	-	-	-	-	250
HC 50 M6 (A0:6)	-	-	-	-	-	-	-	-	250
HC 50 M6 (A5:6)	-	-	-	-	-	-	-	-	250
HC 50 T4 (A0:6)	-	-	-	-	-	-	-	-	250
HC 50 T4 (A5:6)	-	-	-	-	-	-	-	-	250
HC 50 T6 (A0:6)	-	-	-	-	-	-	-	-	250
HC 50 T6 (A5:6)	-	-	-	-	-	-	-	-	250
HC 50 T4/T8 (A0:6)	-	-	-	-	-	-	-	-	250
HC 50 T4/T8 (A5:6)	-	-	-	-	-	-	-	-	250
HC 56 M4 (A2:6)	-	-	-	-	-	-	-	-	250
HC 56 M4 (A2:9)	-	-	-	-	-	-	-	-	250
HC 56 M4 (A5:6)	-	-	-	-	-	-	-	-	250
HC 56 M6 (A2:6)	-	-	-	-	-	-	-	-	250
HC 56 M6 (A2:9)	-	-	-	-	-	-	-	-	250
HC 56 M6 (A5:6)	-	-	-	-	-	-	-	-	250
HC 56 T4 (A2:6)	-	-	-	-	-	-	-	-	250

Model	C' (Mot. T.132M)	C' (Mot. T.132S)	C' (Mot. T.160L)	C' (Mot. T.160M)	C' (Mot. T.180L)	C' (Mot. T.180M)	C' (Mot. T.200)	C' (Mot. T.225)	E
HC 56 T4 (A2:9)	-	-	-	-	-	-	-	-	250
HC 56 T4 (A5:6)	-	-	-	-	-	-	-	-	250
HC 56 T6 (A2:6)	-	-	-	-	-	-	-	-	250
HC 56 T6 (A2:9)	-	-	-	-	-	-	-	-	250
HC 56 T6 (A5:6)	-	-	-	-	-	-	-	-	250
HC 56 T4/T8 (A2:6)	-	-	-	-	-	-	-	-	250
HC 56 T4/T8 (A2:9)	-	-	-	-	-	-	-	-	250
HC 56 T4/T8 (A5:6)	-	-	-	-	-	-	-	-	250
HC 63 M4 (A2:6)	-	-	-	-	-	-	-	-	250
HC 63 M4 (A2:9)	-	-	-	-	-	-	-	-	250
HC 63 M4 (A5:6)	-	-	-	-	-	-	-	-	250
HC 63 M6 (A2:6)	-	-	-	-	-	-	-	-	250
HC 63 M6 (A2:9)	-	-	-	-	-	-	-	-	250
HC 63 M6 (A5:6)	-	-	-	-	-	-	-	-	250
HC 63 T4 (A2:6)	-	-	-	-	-	-	-	-	250
HC 63 T4 (A2:9)	-	-	-	-	-	-	-	-	250
HC 63 T4 (A5:6)	-	-	-	-	-	-	-	-	250
HC 63 T6 (A2:6)	-	-	-	-	-	-	-	-	250
HC 63 T6 (A2:9)	-	-	-	-	-	-	-	-	250
HC 63 T6 (A5:6)	-	-	-	-	-	-	-	-	250
HC 63 T4/T8 (A2:6)	-	-	-	-	-	-	-	-	250
HC 63 T4/T8 (A2:9)	-	-	-	-	-	-	-	-	250
HC 63 T4/T8 (A5:6)	-	-	-	-	-	-	-	-	250
HC 71 M4 (A2:6)	-	-	-	-	-	-	-	-	350
HC 71 M4 (A2:9)	-	-	-	-	-	-	-	-	350
HC 71 M4 (A5:6)	-	-	-	-	-	-	-	-	350
HC 71 M6 (A2:6)	-	-	-	-	-	-	-	-	350
HC 71 M6 (A2:9)	-	-	-	-	-	-	-	-	350
HC 71 M6 (A5:6)	-	-	-	-	-	-	-	-	350
HC 71 T4 (A2:6)	-	-	-	-	-	-	-	-	350
HC 71 T4 (A2:9)	-	-	-	-	-	-	-	-	350
HC 71 T4 (A5:6)	-	-	-	-	-	-	-	-	350
HC 71 T6 (A2:6)	-	-	-	-	-	-	-	-	350
HC 71 T6 (A2:9)	-	-	-	-	-	-	-	-	350
HC 71 T6 (A5:6)	-	-	-	-	-	-	-	-	350
HC 71 T4/T8 (A2:6)	-	-	-	-	-	-	-	-	350
HC 71 T4/T8 (A2:9)	-	-	-	-	-	-	-	-	350
HC 71 T4/T8 (A5:6)	-	-	-	-	-	-	-	-	350
HC 80 T4 (A2:6)	571	533	-	-	-	-	-	-	350
HC 80 T4 (A2:9)	571	533	-	-	-	-	-	-	350

Model	C' (Mot. T.132M)	C' (Mot. T.132S)	C' (Mot. T.160L)	C' (Mot. T.160M)	C' (Mot. T.180L)	C' (Mot. T.180M)	C' (Mot. T.200)	C' (Mot. T.225)	E
HC 80 T4 (A5:6)	571	533	-	-	-	-	-	-	350
HC 80 T6 (A2:6)	571	533	-	-	-	-	-	-	350
HC 80 T6 (A2:9)	571	533	-	-	-	-	-	-	350
HC 80 T6 (A5:6)	571	533	-	-	-	-	-	-	350
HC 80 T4/T8 (A2:6)	571	533	-	-	-	-	-	-	350
HC 80 T4/T8 (A2:9)	571	533	-	-	-	-	-	-	350
HC 80 T4/T8 (A5:6)	571	533	-	-	-	-	-	-	350
HC 90 T4 (A6:3)	-	-	762	718	794	756	-	-	425
HC 90 T4 (A6:6)	-	-	762	718	794	756	-	-	425
HC 90 T6 (A6:3)	-	-	762	718	794	756	-	-	425
HC 90 T6 (A6:6)	-	-	762	718	794	756	-	-	425
HC 90 T4/T8 (A6:3)	-	-	762	718	794	756	-	-	425
HC 90 T4/T8 (A6:6)	-	-	762	718	794	756	-	-	425
HC 100 T4 (A6:3)	-	-	762	718	794	756	-	-	425
HC 100 T4 (A6:6)	-	-	762	718	794	756	-	-	425
HC 100 T6 (A6:3)	-	-	762	718	794	756	-	-	425
HC 100 T6 (A6:6)	-	-	762	718	794	756	-	-	425
HC 100 T4/T8 (A6:3)	-	-	762	718	794	756	-	-	425
HC 100 T4/T8 (A6:6)	-	-	762	718	794	756	-	-	425
HC 112 T4 (A6:3)	-	-	772	765	804	766	869	954	500
HC 112 T4 (A6:6)	-	-	772	765	804	766	869	954	500
HC 112 T6 (A6:3)	-	-	772	765	804	766	869	954	500
HC 112 T6 (A6:6)	-	-	772	765	804	766	869	954	500
HC 112 T4/T8 (A6:3)	-	-	772	765	804	766	869	954	500
HC 112 T4/T8 (A6:6)	-	-	772	765	804	766	869	954	500
HC 125 T4 (A7:4)	-	-	772	765	804	766	869	954	500
HC 125 T4 (A7:8)	-	-	772	765	804	766	869	954	500
HC 125 T6 (A7:4)	-	-	772	765	804	766	869	954	500
HC 125 T6 (A7:8)	-	-	772	765	804	766	869	954	500
HC 125 T4/T8 (A7:4)	-	-	772	765	804	766	869	954	500
HC 125 T4/T8 (A7:8)	-	-	772	765	804	766	869	954	500

Model	O	ØA	ØB	ØD	ØJ
HC 35 M4 (A0:6)	8x45°	434	395	365	10
HC 35 T4 (A0:6)	8x45°	434	395	365	10
HC 35 T6 (A0:6)	8x45°	434	395	365	10
HC 35 T4/T8 (A0:6)	8x45°	434	395	365	10
HC 40 M4 (A0:6)	8x45°	472	450	403	10
HC 40 T4 (A0:6)	8x45°	472	450	403	10
HC 40 T6 (A0:6)	8x45°	472	450	403	10

Model	O	ØA	ØB	ØD	ØJ
HC 40 T4/T8 (A0:6)	8x45°	472	450	403	10
HC 45 M4 (A0:6)	8X45°	525	500	452	12
HC 45 M4 (A5:6)	8X45°	525	500	452	12
HC 45 M6 (A0:6)	8X45°	525	500	452	12
HC 45 M6 (A5:6)	8X45°	525	500	452	12
HC 45 T4 (A0:6)	8X45°	525	500	452	12
HC 45 T4 (A5:6)	8X45°	525	500	452	12
HC 45 T6 (A0:6)	8X45°	525	500	452	12
HC 45 T6 (A5:6)	8X45°	525	500	452	12
HC 45 T4/T8 (A0:6)	8X45°	525	500	452	12
HC 45 T4/T8 (A5:6)	8X45°	525	500	452	12
HC 50 M4 (A0:6)	12x30°	600	560	504	12
HC 50 M4 (A5:6)	12x30°	600	560	504	12
HC 50 M6 (A0:6)	12x30°	600	560	504	12
HC 50 M6 (A5:6)	12x30°	600	560	504	12
HC 50 T4 (A0:6)	12x30°	600	560	504	12
HC 50 T4 (A5:6)	12x30°	600	560	504	12
HC 50 T6 (A0:6)	12x30°	600	560	504	12
HC 50 T6 (A5:6)	12x30°	600	560	504	12
HC 50 T4/T8 (A0:6)	12x30°	600	560	504	12
HC 50 T4/T8 (A5:6)	12x30°	600	560	504	12
HC 56 M4 (A2:6)	12X30°	646	620	559	12
HC 56 M4 (A2:9)	12X30°	646	620	559	12
HC 56 M4 (A5:6)	12X30°	646	620	559	12
HC 56 M6 (A2:6)	12X30°	646	620	559	12
HC 56 M6 (A2:9)	12X30°	646	620	559	12
HC 56 M6 (A5:6)	12X30°	646	620	559	12
HC 56 T4 (A2:6)	12X30°	646	620	559	12
HC 56 T4 (A2:9)	12X30°	646	620	559	12
HC 56 T4 (A5:6)	12X30°	646	620	559	12
HC 56 T6 (A2:6)	12X30°	646	620	559	12
HC 56 T6 (A2:9)	12X30°	646	620	559	12
HC 56 T6 (A5:6)	12X30°	646	620	559	12
HC 56 T4/T8 (A2:6)	12X30°	646	620	559	12
HC 56 T4/T8 (A2:9)	12X30°	646	620	559	12
HC 56 T4/T8 (A5:6)	12X30°	646	620	559	12
HC 63 M4 (A2:6)	12X30°	725	690	633	12
HC 63 M4 (A2:9)	12X30°	725	690	633	12
HC 63 M4 (A5:6)	12X30°	725	690	633	12
HC 63 M6 (A2:6)	12X30°	725	690	633	12

Model	O	ØA	ØB	ØD	ØJ
HC 63 M6 (A2:9)	12X30 ^º	725	690	633	12
HC 63 M6 (A5:6)	12X30 ^º	725	690	633	12
HC 63 T4 (A2:6)	12X30 ^º	725	690	633	12
HC 63 T4 (A2:9)	12X30 ^º	725	690	633	12
HC 63 T4 (A5:6)	12X30 ^º	725	690	633	12
HC 63 T6 (A2:6)	12X30 ^º	725	690	633	12
HC 63 T6 (A2:9)	12X30 ^º	725	690	633	12
HC 63 T6 (A5:6)	12X30 ^º	725	690	633	12
HC 63 T4/T8 (A2:6)	12X30 ^º	725	690	633	12
HC 63 T4/T8 (A2:9)	12X30 ^º	725	690	633	12
HC 63 T4/T8 (A5:6)	12X30 ^º	725	690	633	12
HC 71 M4 (A2:6)	16x22,5 ^º	802	770	715	12
HC 71 M4 (A2:9)	16x22,5 ^º	802	770	715	12
HC 71 M4 (A5:6)	16x22,5 ^º	802	770	715	12
HC 71 M6 (A2:6)	16x22,5 ^º	802	770	715	12
HC 71 M6 (A2:9)	16x22,5 ^º	802	770	715	12
HC 71 M6 (A5:6)	16x22,5 ^º	802	770	715	12
HC 71 T4 (A2:6)	16x22,5 ^º	802	770	715	12
HC 71 T4 (A2:9)	16x22,5 ^º	802	770	715	12
HC 71 T4 (A5:6)	16x22,5 ^º	802	770	715	12
HC 71 T6 (A2:6)	16x22,5 ^º	802	770	715	12
HC 71 T6 (A2:9)	16x22,5 ^º	802	770	715	12
HC 71 T6 (A5:6)	16x22,5 ^º	802	770	715	12
HC 71 T4/T8 (A2:6)	16x22,5 ^º	802	770	715	12
HC 71 T4/T8 (A2:9)	16x22,5 ^º	802	770	715	12
HC 71 T4/T8 (A5:6)	16x22,5 ^º	802	770	715	12
HC 80 T4 (A2:6)	16x22,5 ^º	892	860	801	12
HC 80 T4 (A2:9)	16x22,5 ^º	892	860	801	12
HC 80 T4 (A5:6)	16x22,5 ^º	892	860	801	12
HC 80 T6 (A2:6)	16x22,5 ^º	892	860	801	12
HC 80 T6 (A2:9)	16x22,5 ^º	892	860	801	12
HC 80 T6 (A5:6)	16x22,5 ^º	892	860	801	12
HC 80 T4/T8 (A2:6)	16x22,5 ^º	892	860	801	12
HC 80 T4/T8 (A2:9)	16x22,5 ^º	892	860	801	12
HC 80 T4/T8 (A5:6)	16x22,5 ^º	892	860	801	12
HC 90 T4 (A6:3)	16x22,5 ^º	1000	970	903.5	12
HC 90 T4 (A6:6)	16x22,5 ^º	1000	970	903.5	12
HC 90 T6 (A6:3)	16x22,5 ^º	1000	970	903.5	12
HC 90 T6 (A6:6)	16x22,5 ^º	1000	970	903.5	12
HC 90 T4/T8 (A6:3)	16x22,5 ^º	1000	970	903.5	12

Model	O	ØA	ØB	ØD	ØJ
HC 90 T4/T8 (A6:6)	16x22,5º	1000	970	903.5	12
HC 100 T4 (A6:3)	16x22,5º	1115	1070	1013	12
HC 100 T4 (A6:6)	16x22,5º	1115	1070	1013	12
HC 100 T6 (A6:3)	16x22,5º	1115	1070	1013	12
HC 100 T6 (A6:6)	16x22,5º	1115	1070	1013	12
HC 100 T4/T8 (A6:3)	16x22,5º	1115	1070	1013	12
HC 100 T4/T8 (A6:6)	16x22,5º	1115	1070	1013	12
HC 112 T4 (A6:3)	16x22,5º	1234	1190	1132	12
HC 112 T4 (A6:6)	16x22,5º	1234	1190	1132	12
HC 112 T6 (A6:3)	16x22,5º	1234	1190	1132	12
HC 112 T6 (A6:6)	16x22,5º	1234	1190	1132	12
HC 112 T4/T8 (A6:3)	16x22,5º	1234	1190	1132	12
HC 112 T4/T8 (A6:6)	16x22,5º	1234	1190	1132	12
HC 125 T4 (A7:4)	20x18º	1365	1320	1263	15
HC 125 T4 (A7:8)	20x18º	1365	1320	1263	15
HC 125 T6 (A7:4)	20x18º	1365	1320	1263	15
HC 125 T6 (A7:8)	20x18º	1365	1320	1263	15
HC 125 T4/T8 (A7:4)	20x18º	1365	1320	1263	15
HC 125 T4/T8 (A7:8)	20x18º	1365	1320	1263	15

Wiring diagram

DIAGRAM N° 1

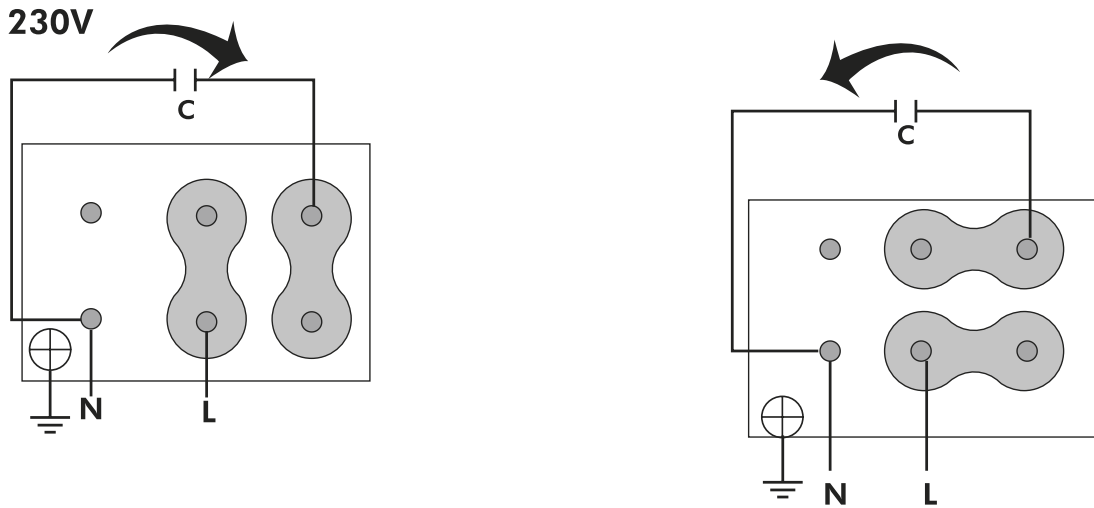

DIAGRAM N° 2

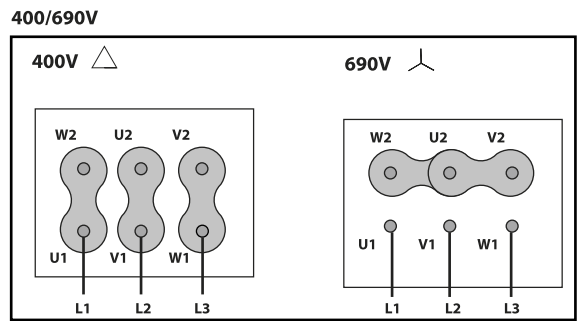
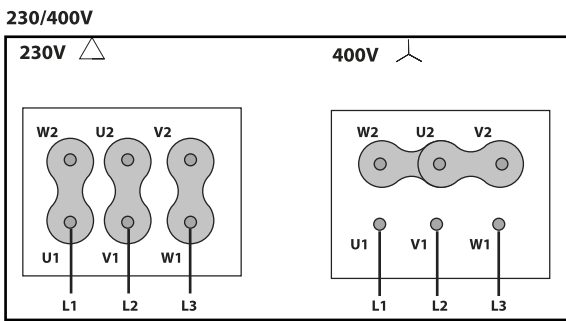
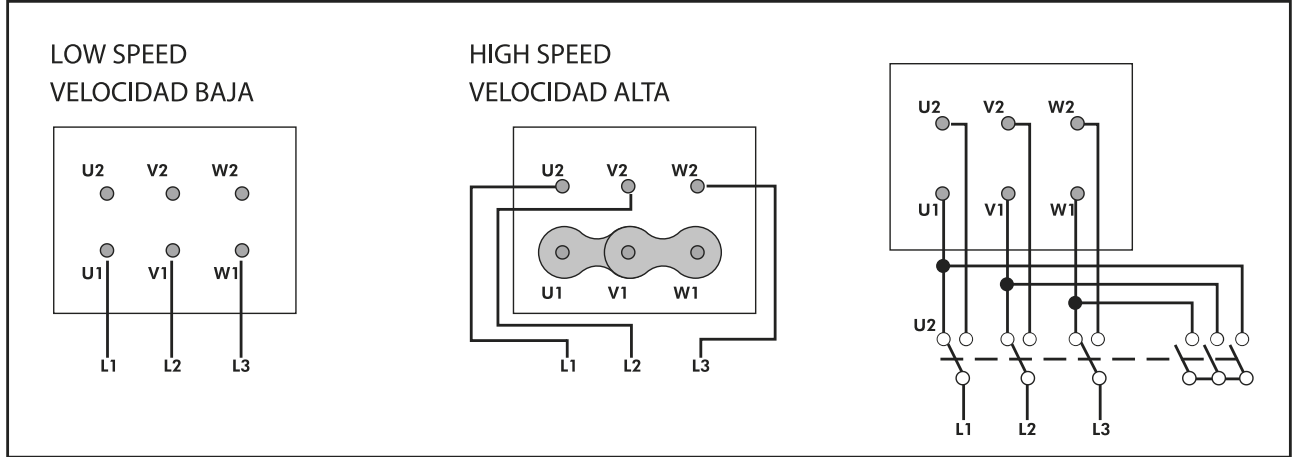

DIAGRAM Nº 3

400V DAHLANDER (Y,YY)



CHARACTERISTIC CURVE

HC 35 M4 (A0:6)

AIR FLOW - PRESSURE

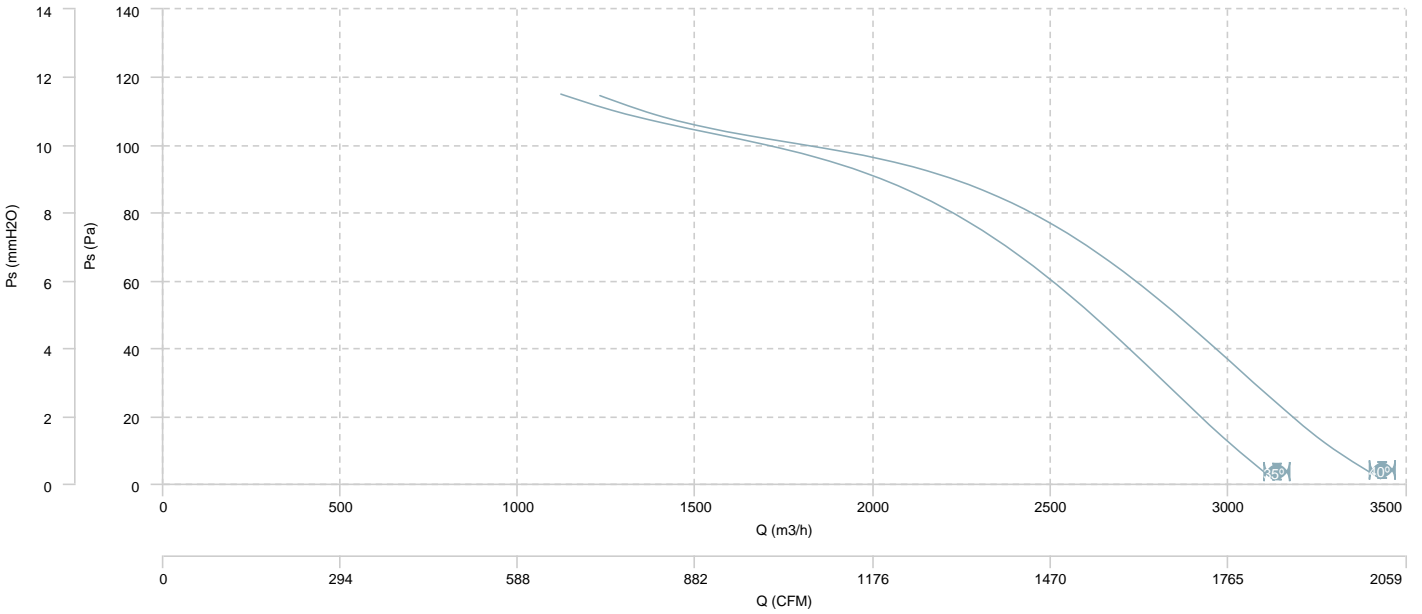

AIR FLOW - MECHANICAL POWER

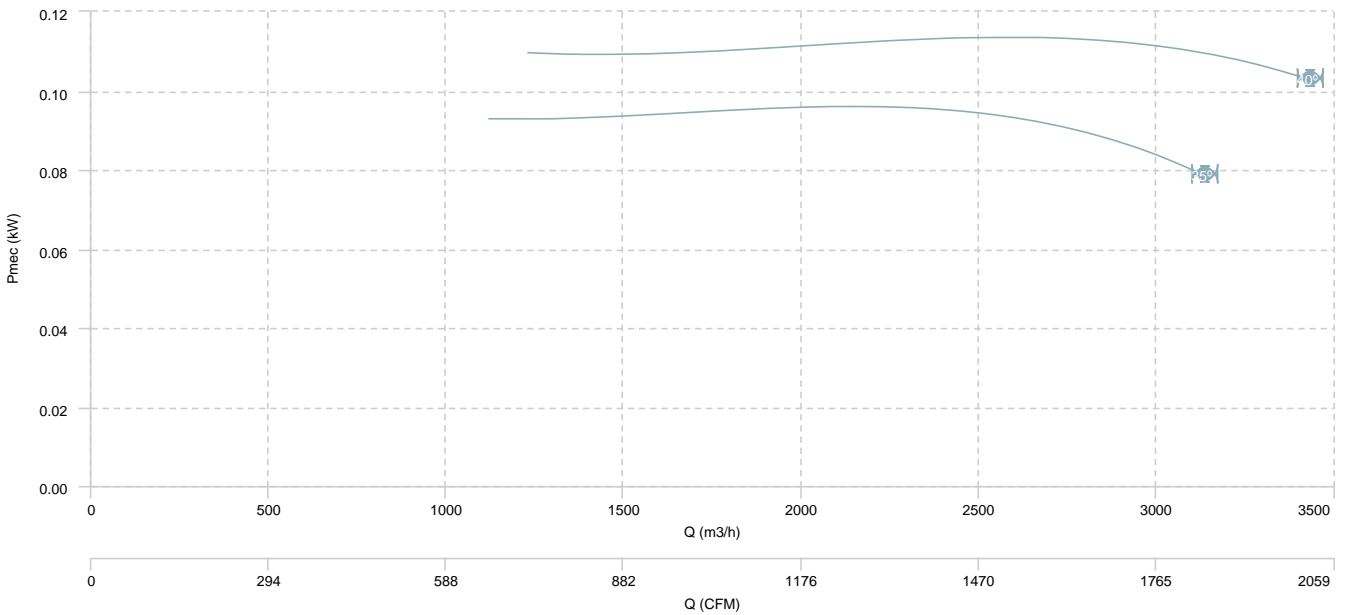

HC 40 M4 (A0:6)

AIR FLOW - PRESSURE

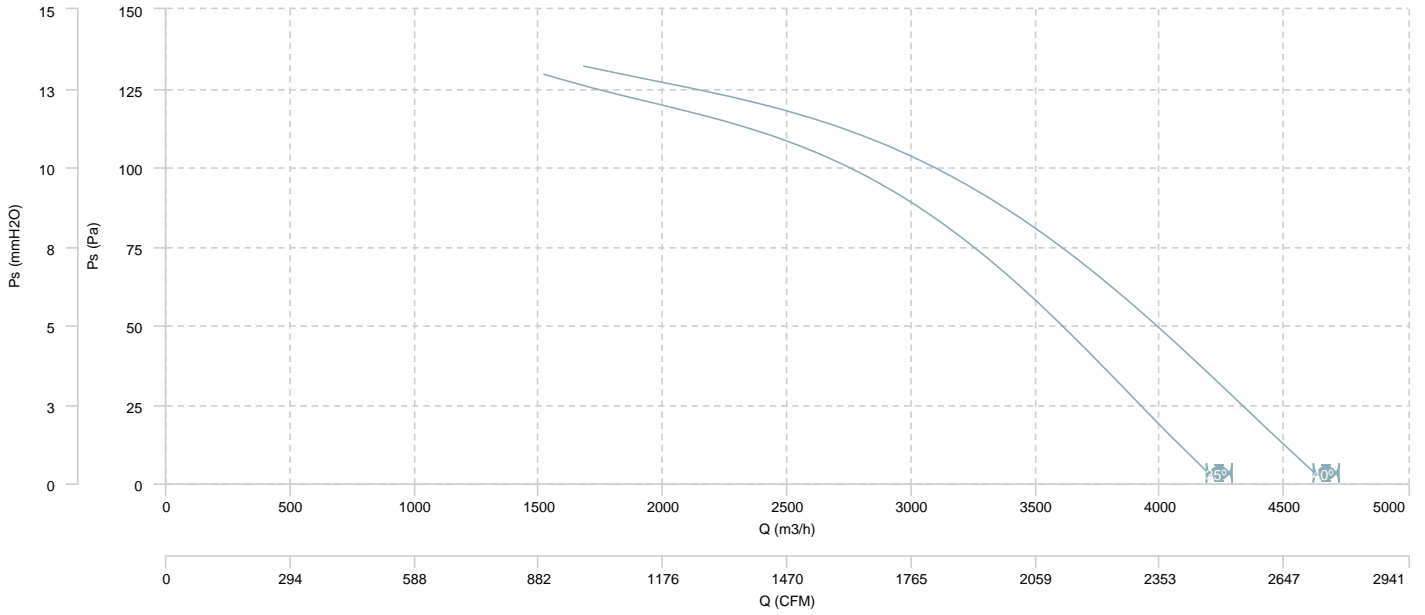

AIR FLOW - MECHANICAL POWER

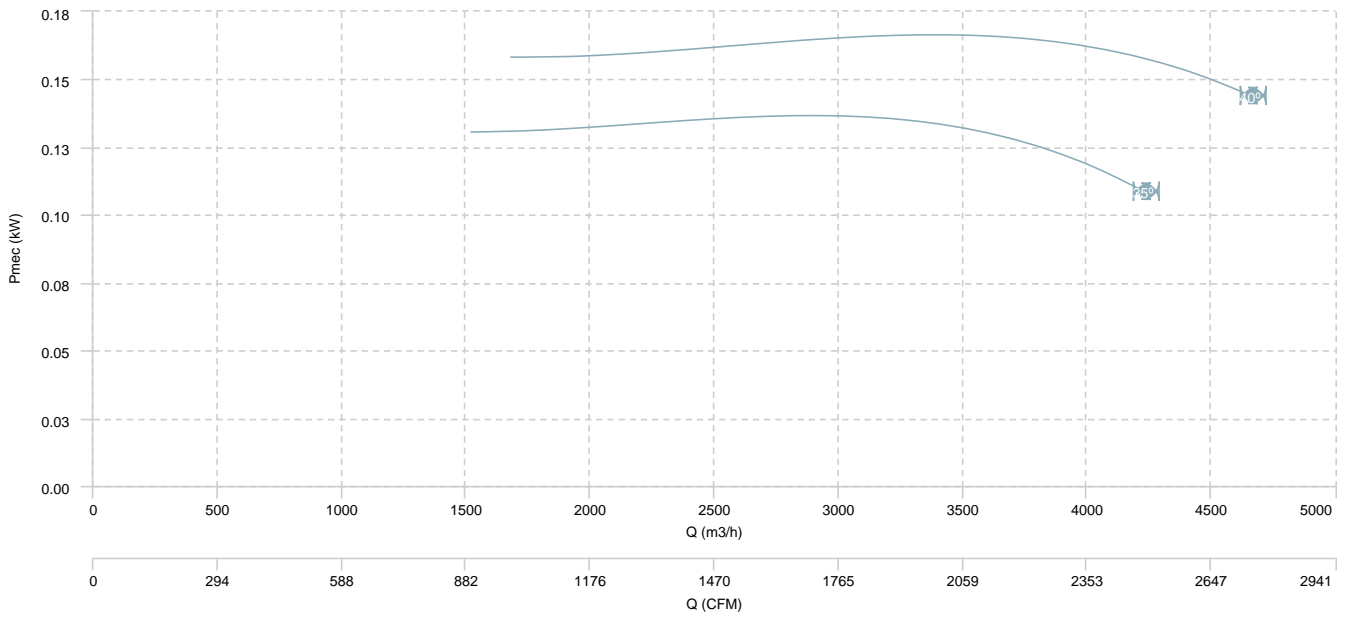

HC 45 M4 (A0:6)

AIR FLOW - PRESSURE

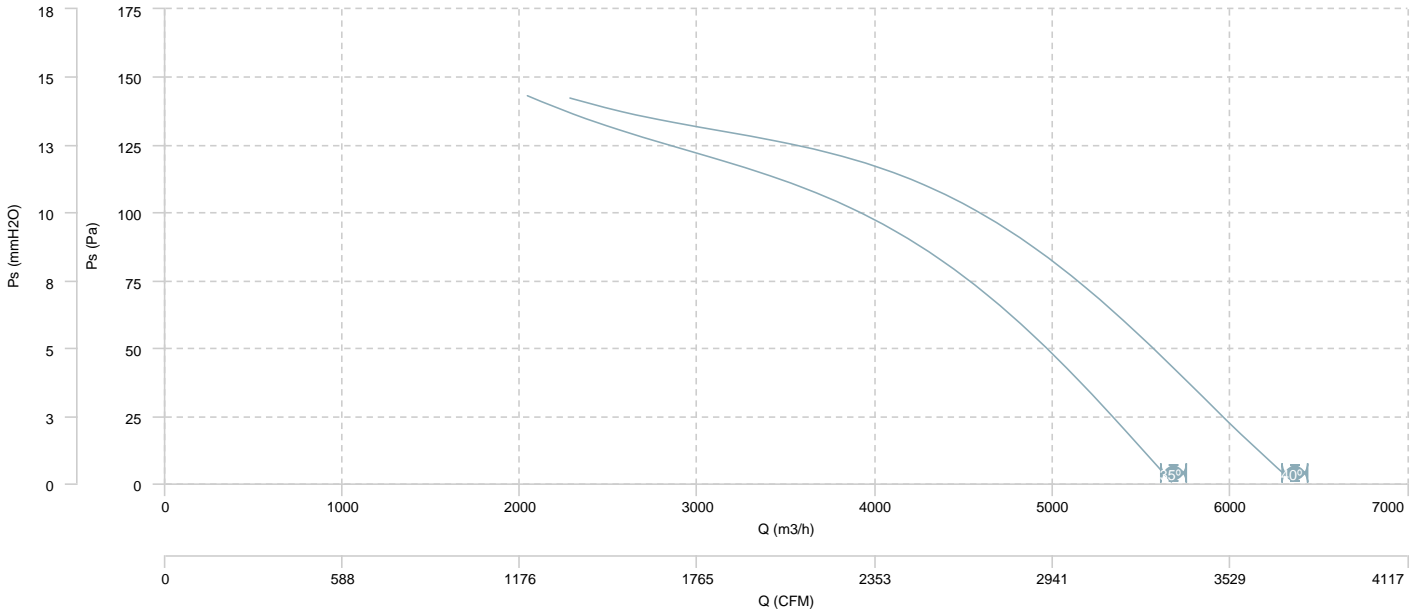

AIR FLOW - MECHANICAL POWER

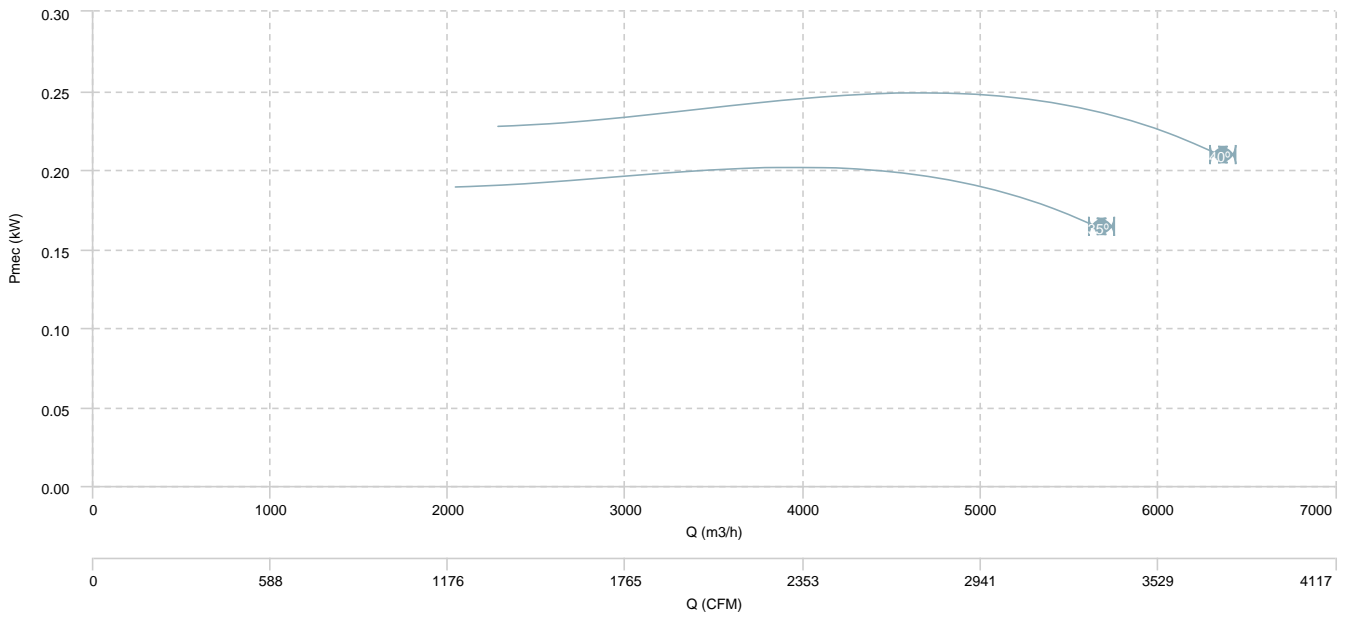

HC 45 M4 (A5:6)

AIR FLOW - PRESSURE

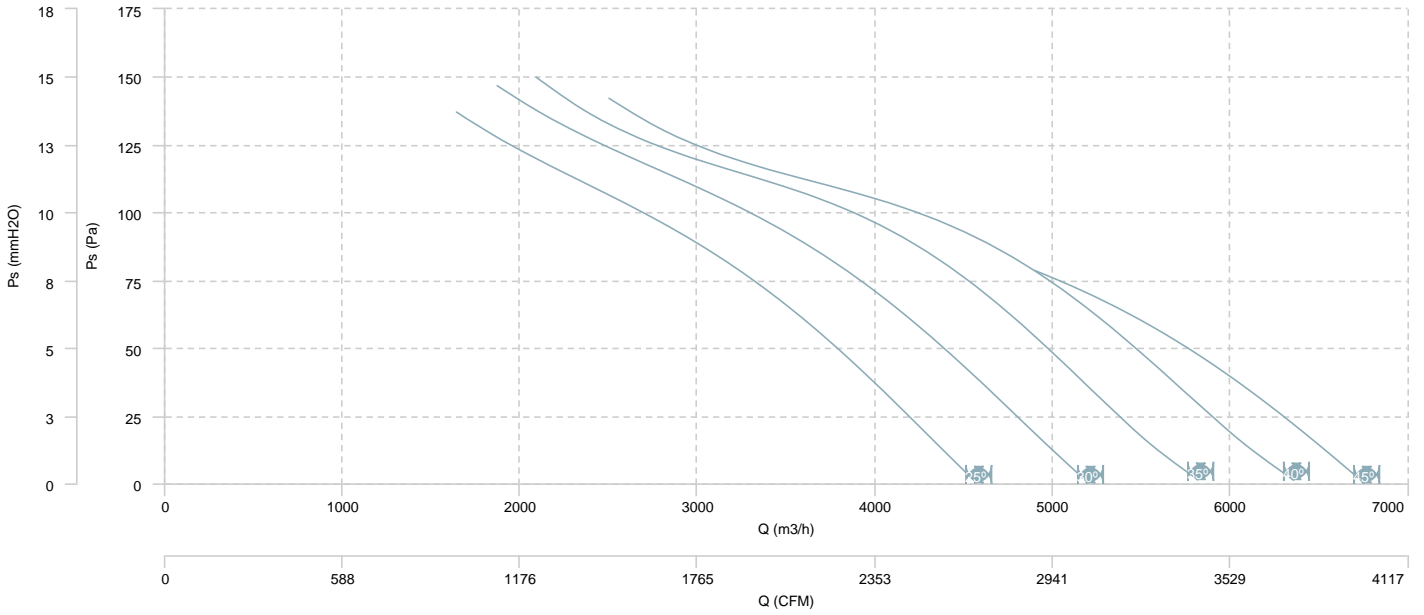

AIR FLOW - MECHANICAL POWER

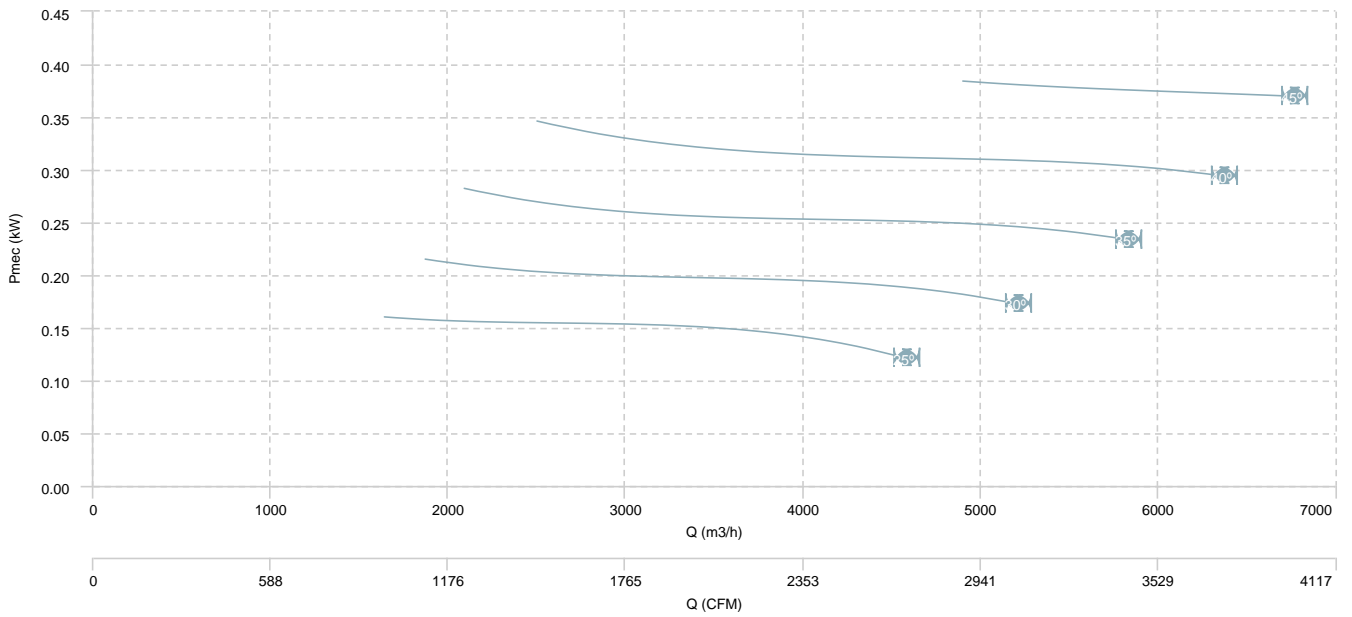

HC 45 M6 (A0:6)

AIR FLOW - PRESSURE

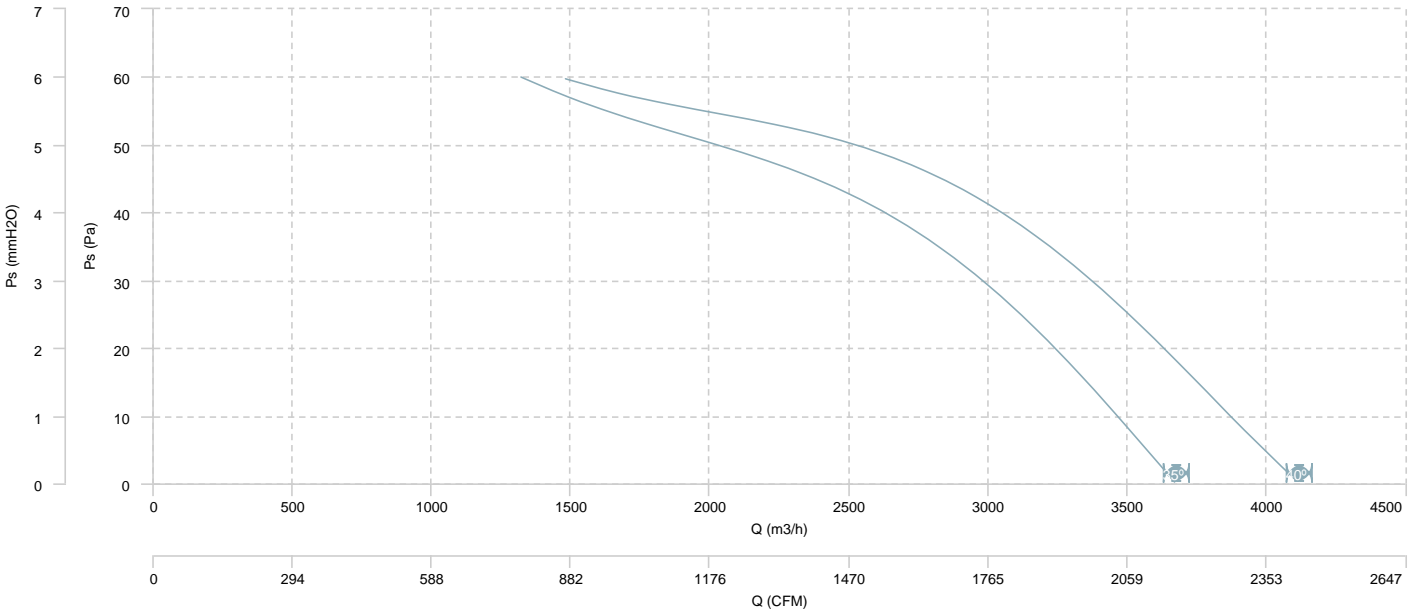

AIR FLOW - MECHANICAL POWER

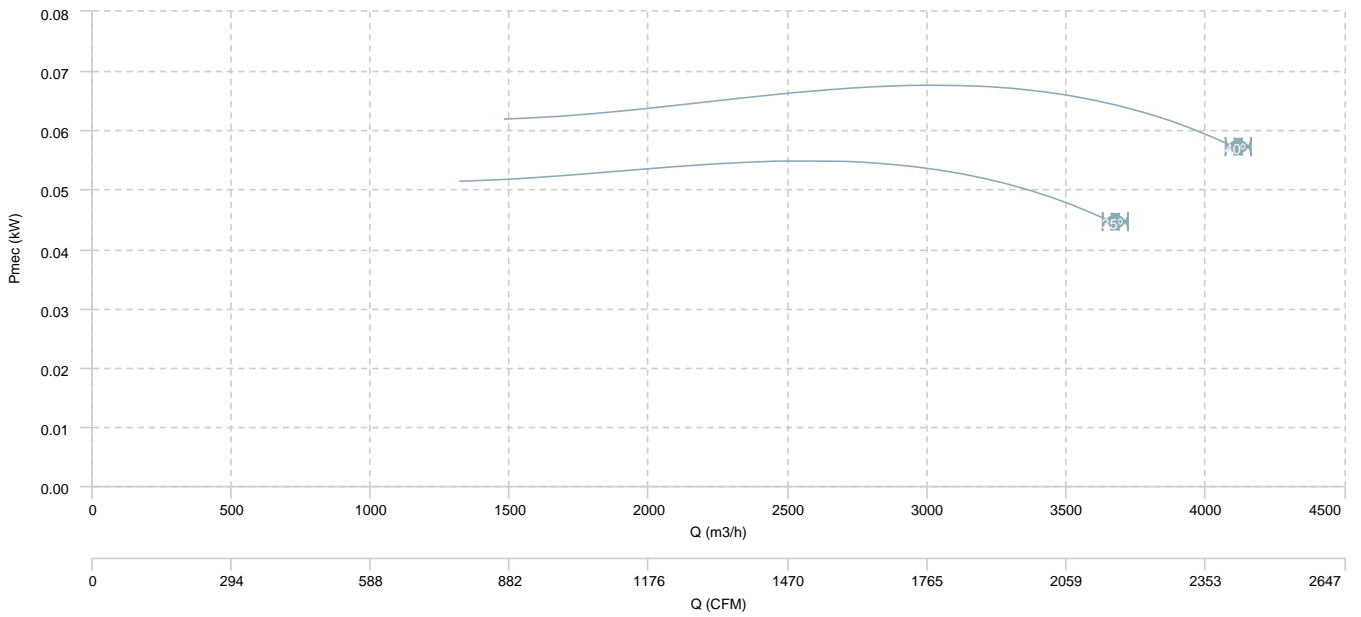

HC 45 M6 (A5:6)

AIR FLOW - PRESSURE

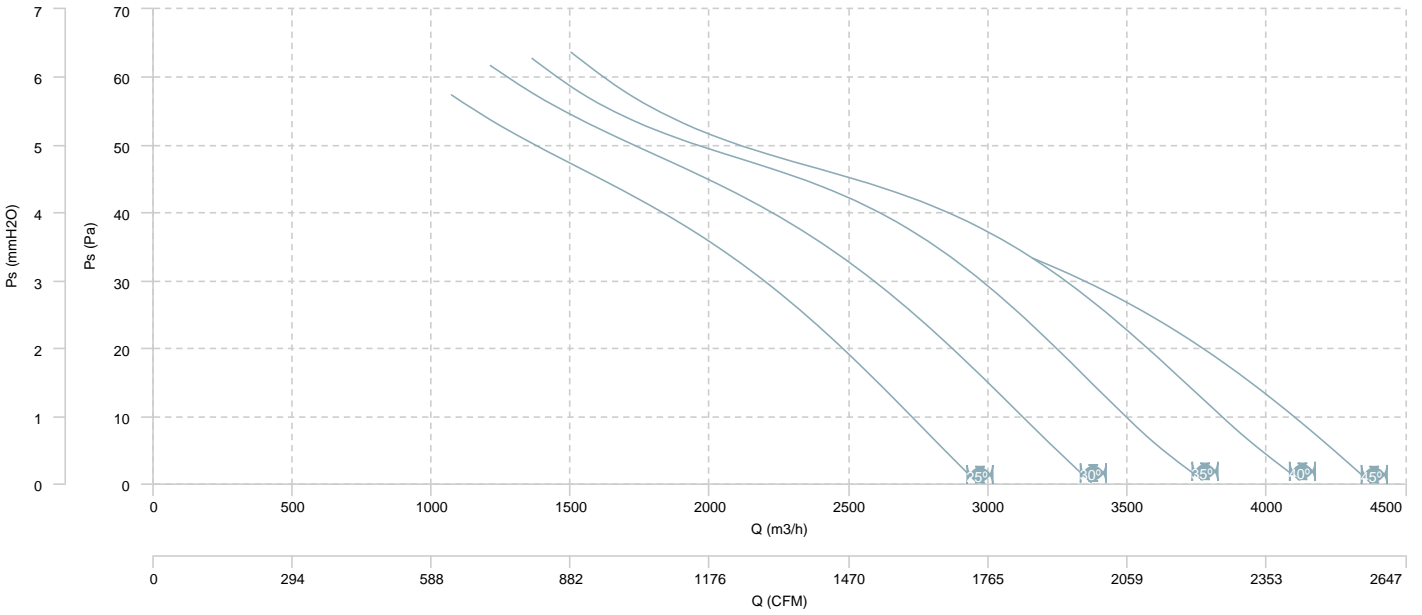

AIR FLOW - MECHANICAL POWER

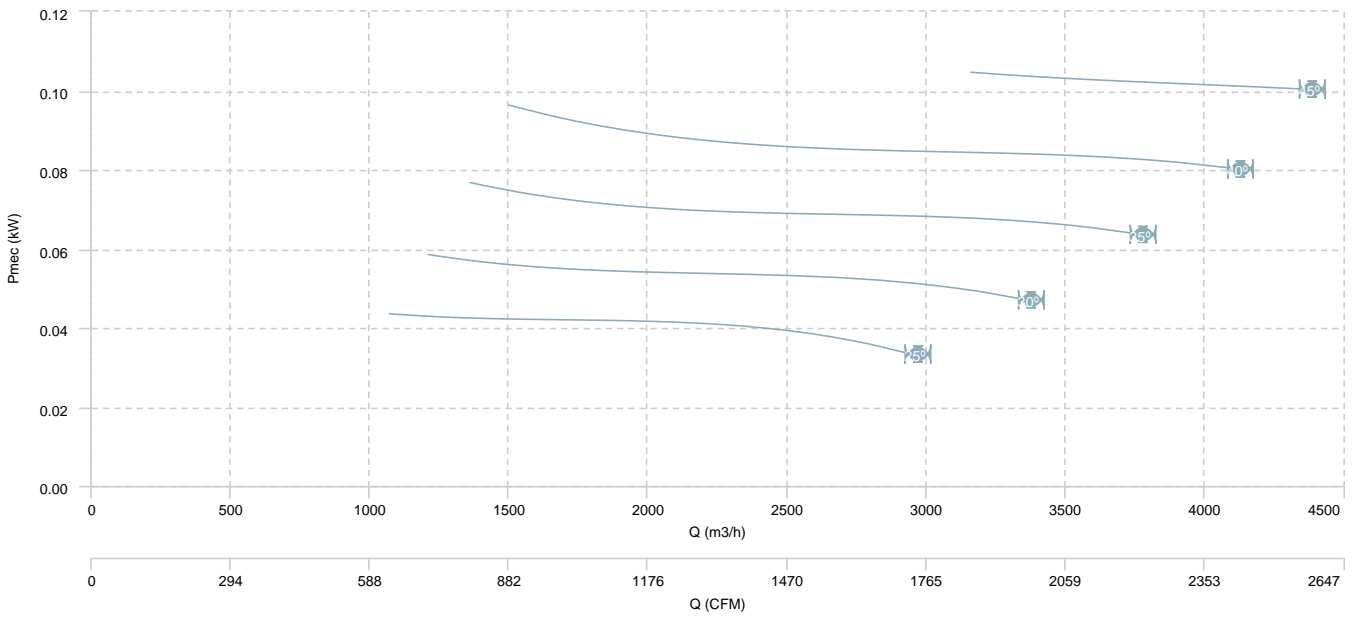

HC 50 M4 (A0:6)

AIR FLOW - PRESSURE

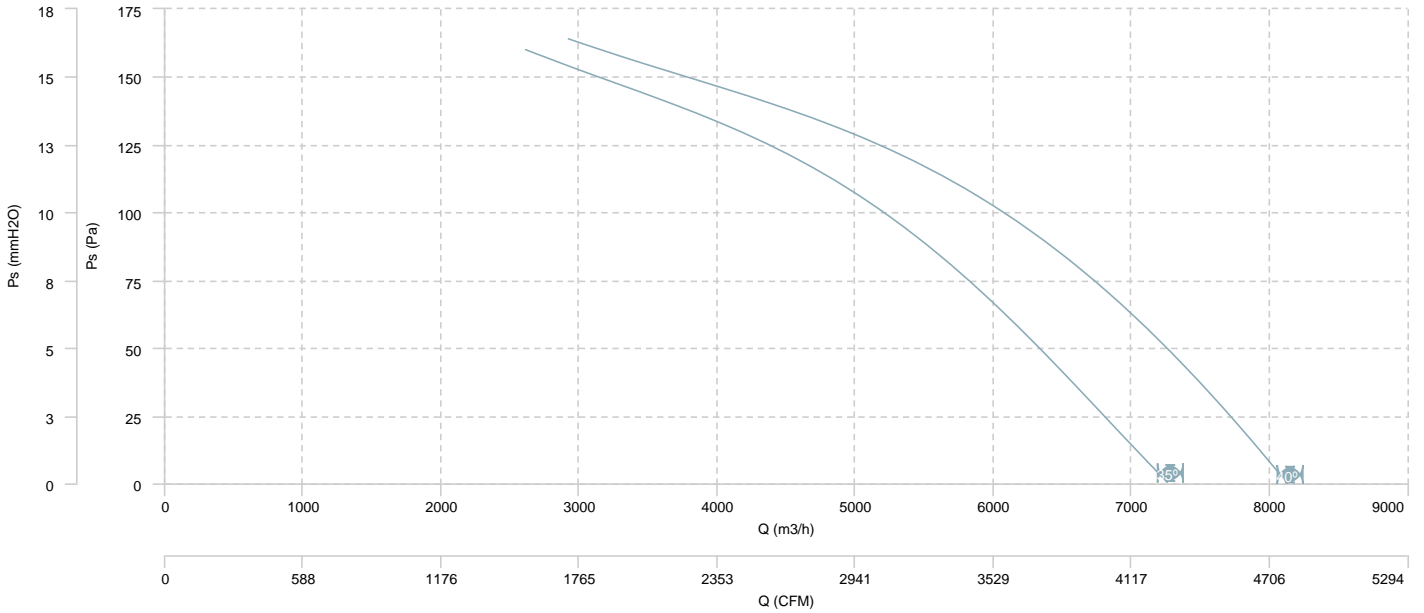

AIR FLOW - MECHANICAL POWER

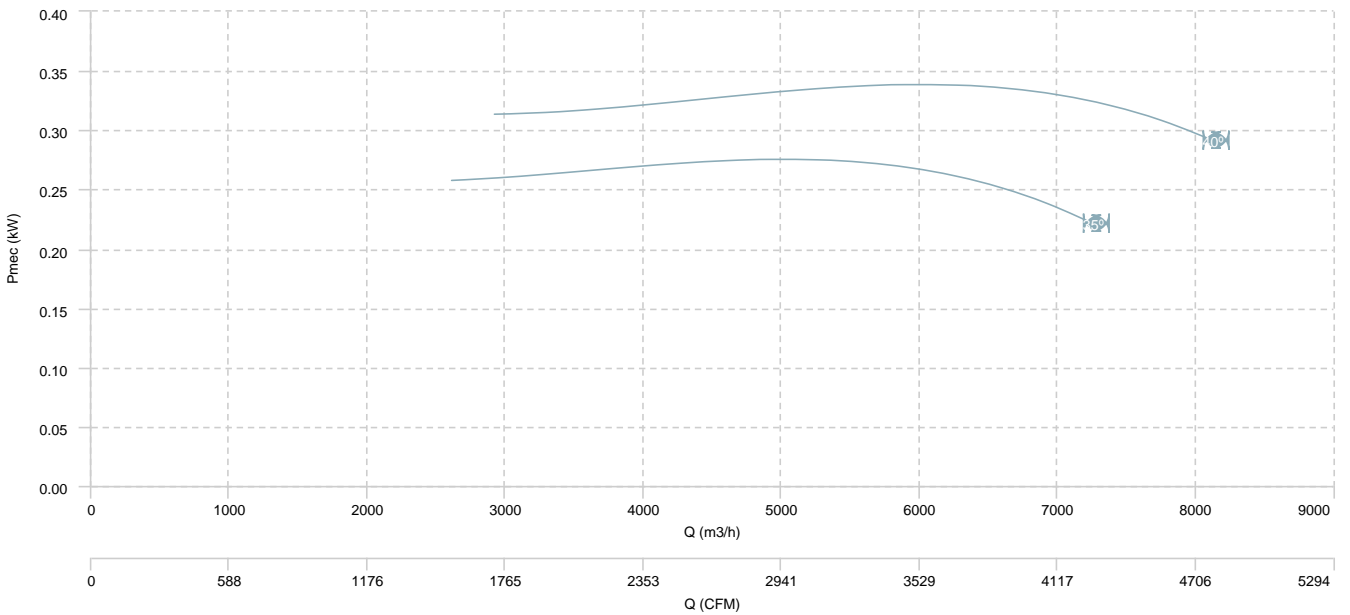

HC 50 M4 (A5:6)

AIR FLOW - PRESSURE

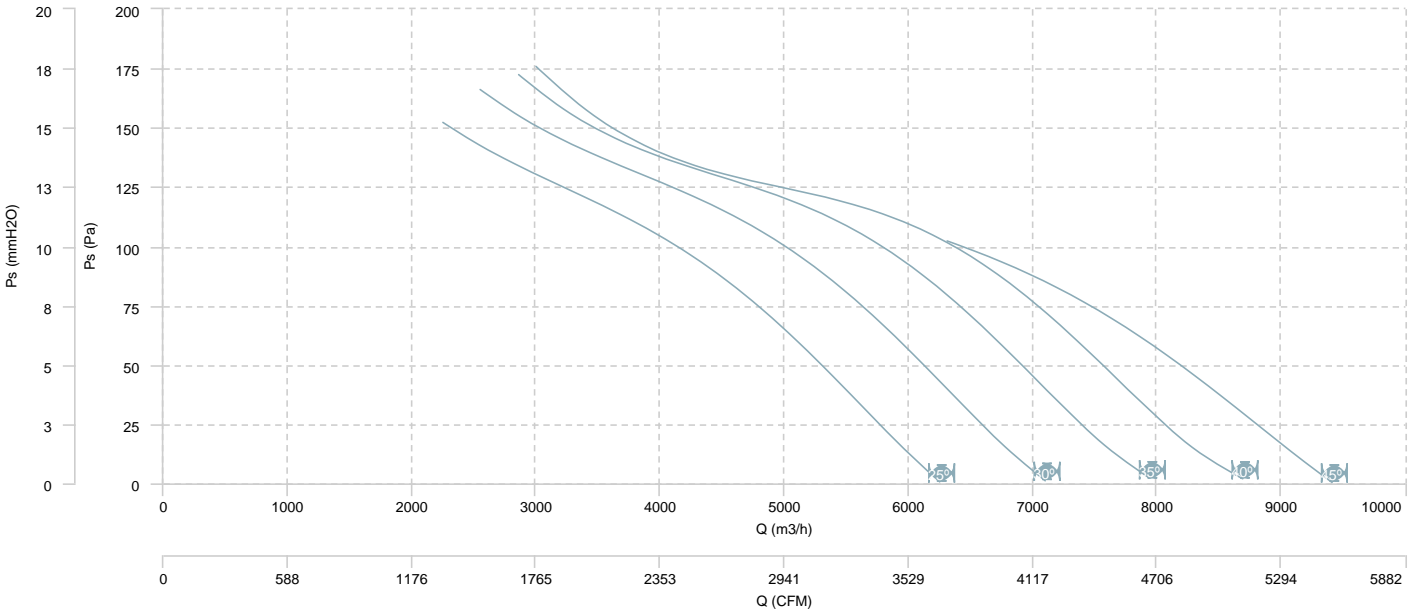

AIR FLOW - MECHANICAL POWER

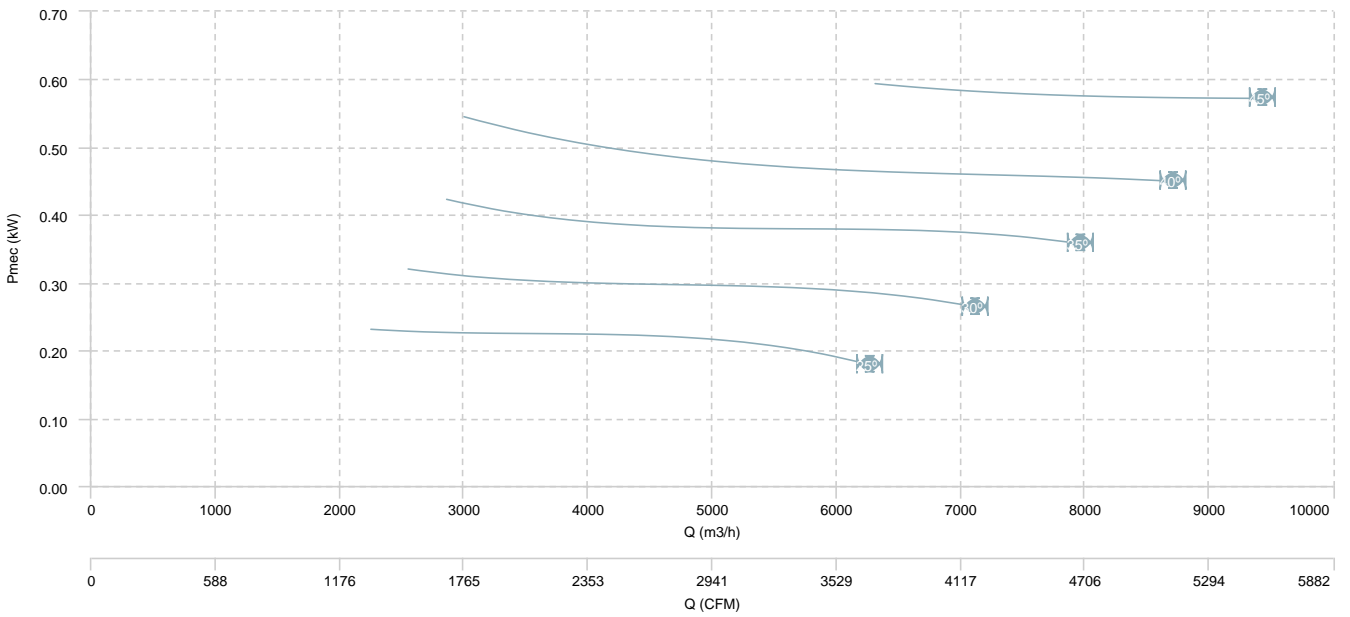

HC 50 M6 (A0:6)

AIR FLOW - PRESSURE

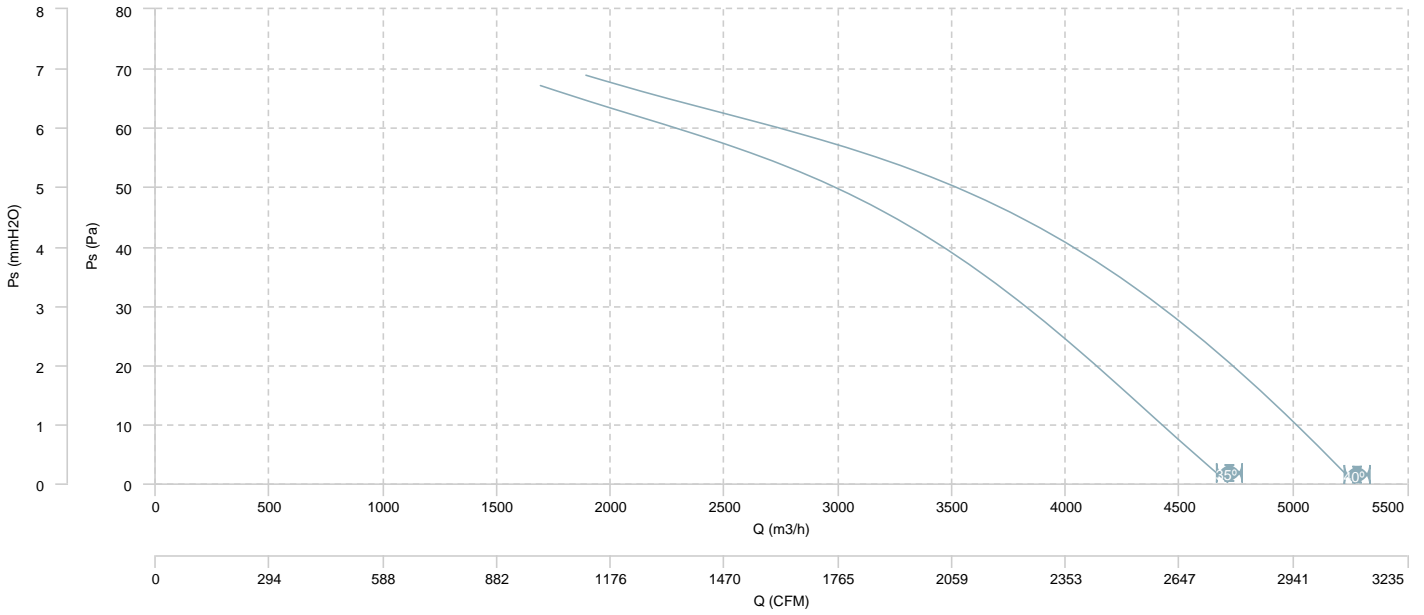

AIR FLOW - MECHANICAL POWER

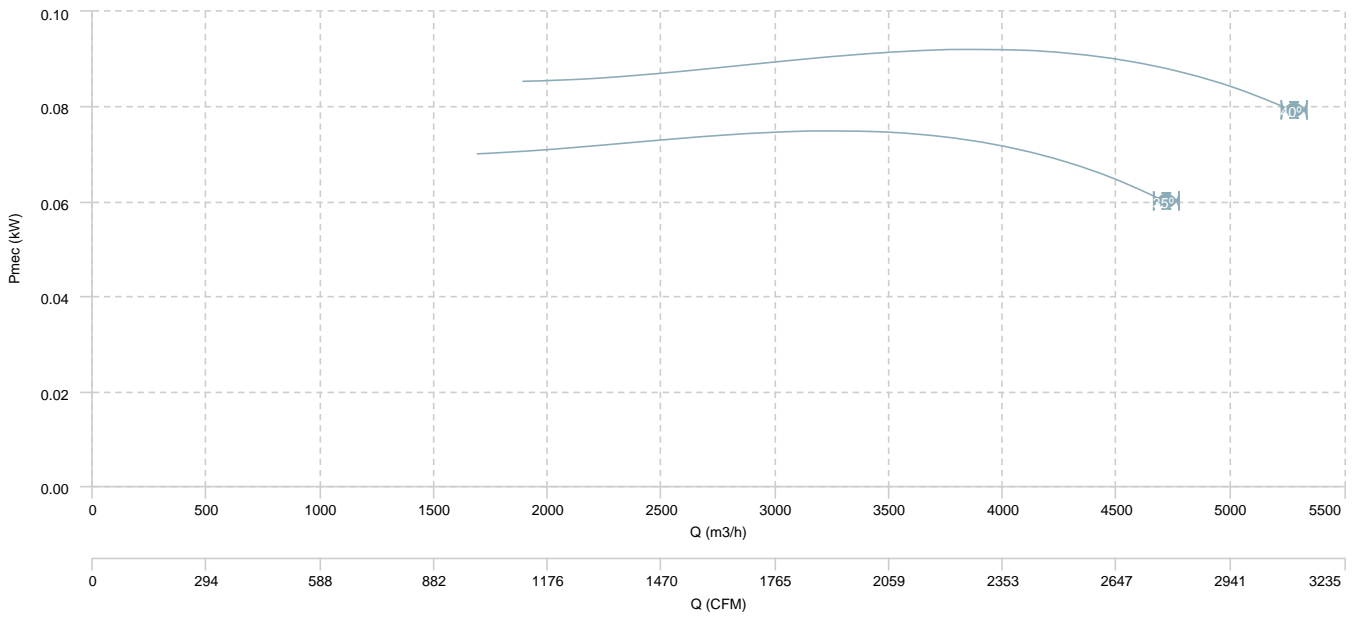

HC 50 M6 (A5:6)

AIR FLOW - PRESSURE

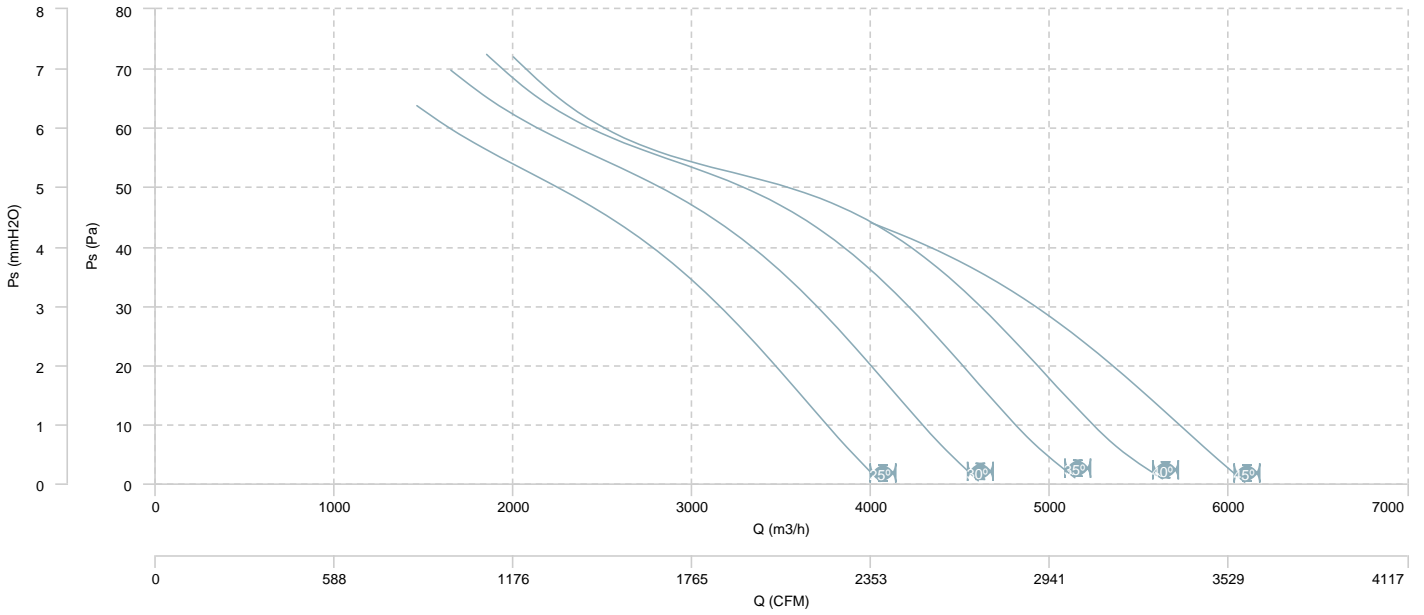

AIR FLOW - MECHANICAL POWER

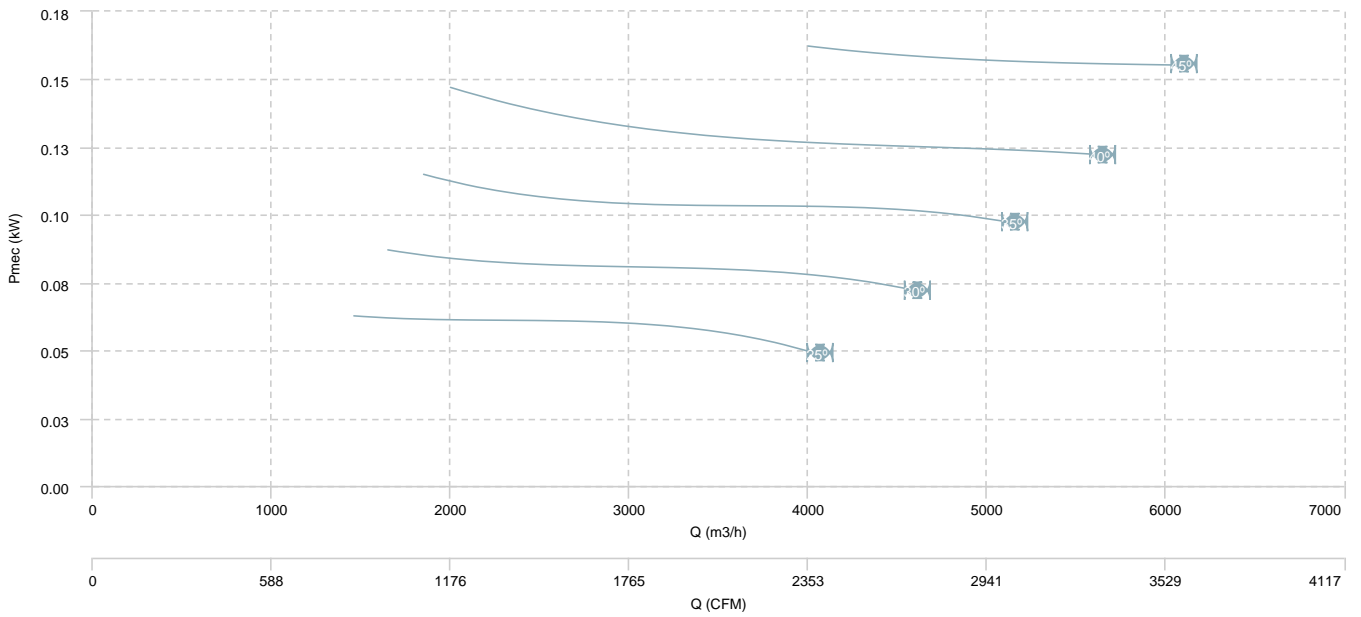

HC 56 M4 (A5:6)

AIR FLOW - PRESSURE

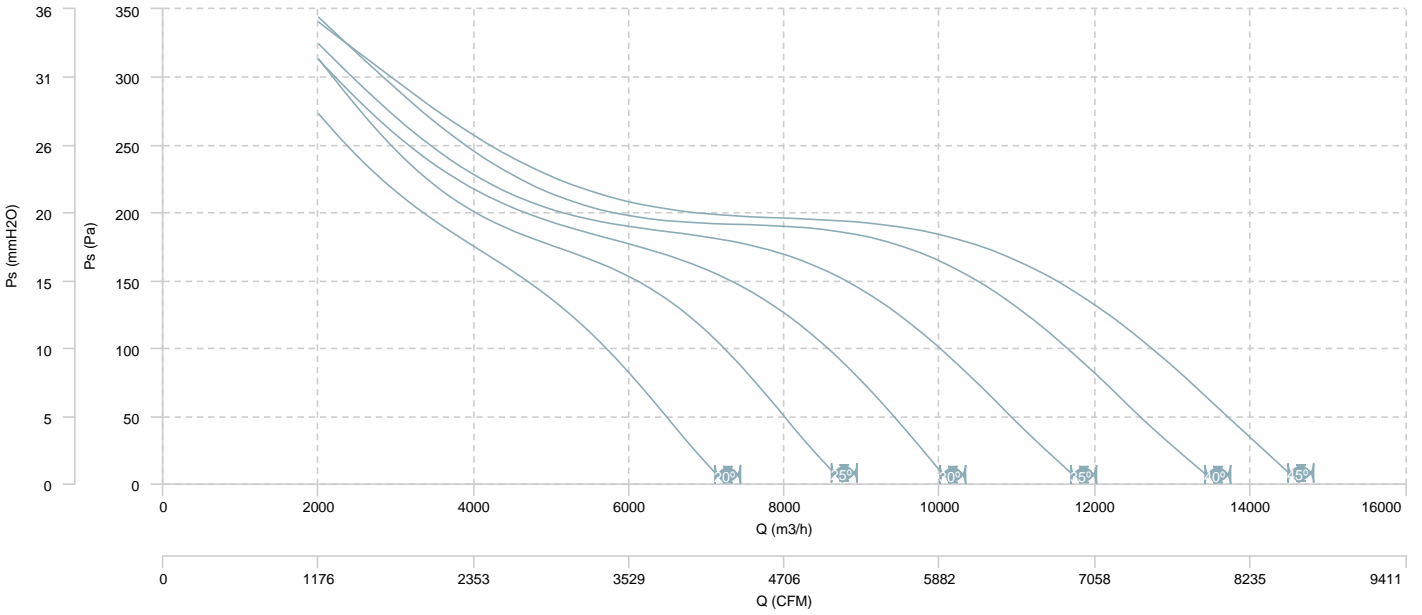

AIR FLOW - MECHANICAL POWER

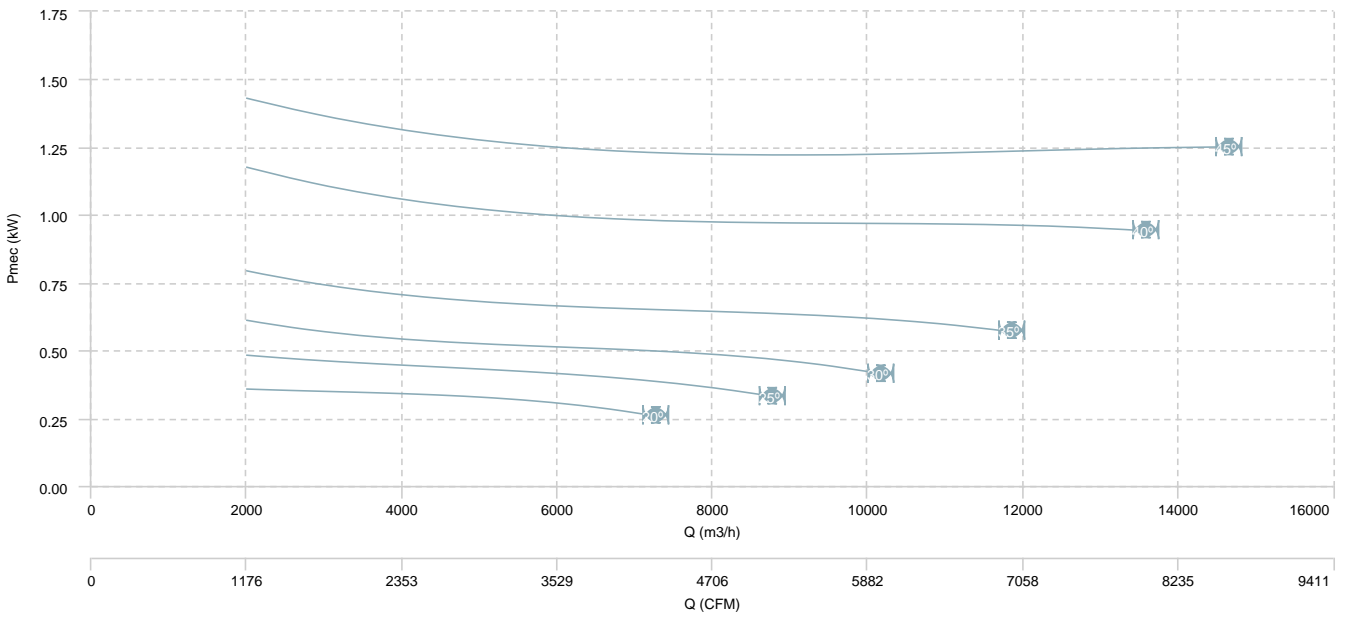

HC 56 M4 (A2:9)

AIR FLOW - PRESSURE

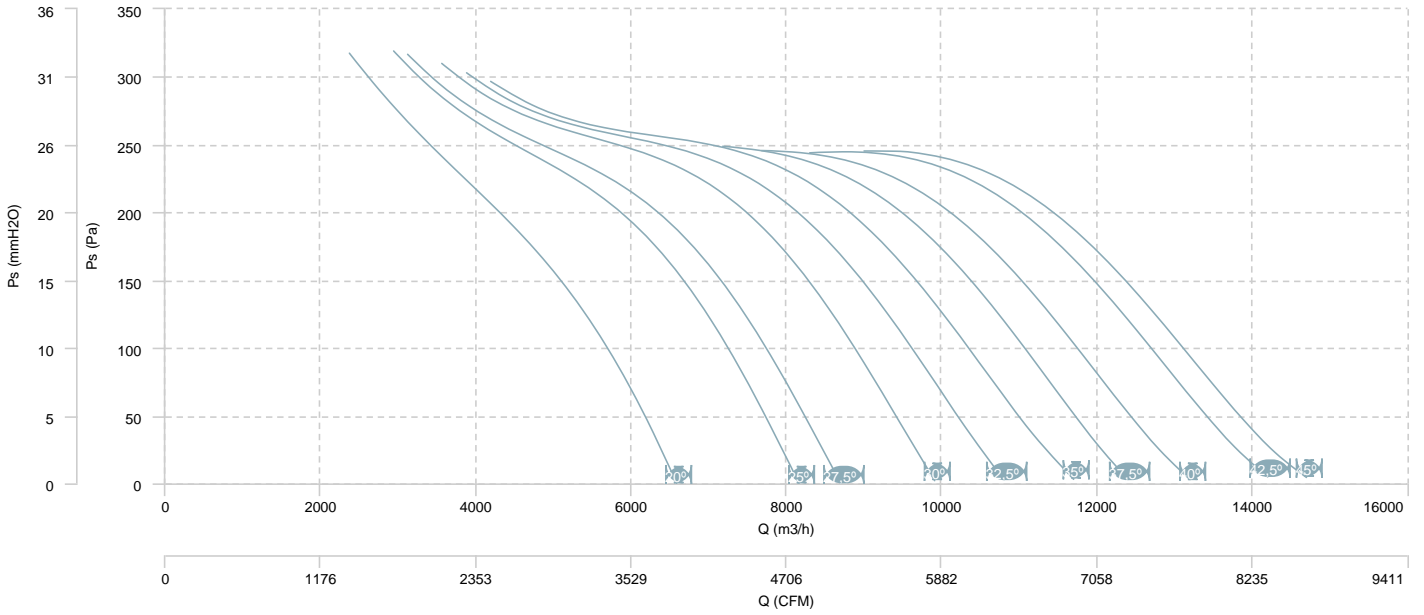

AIR FLOW - MECHANICAL POWER

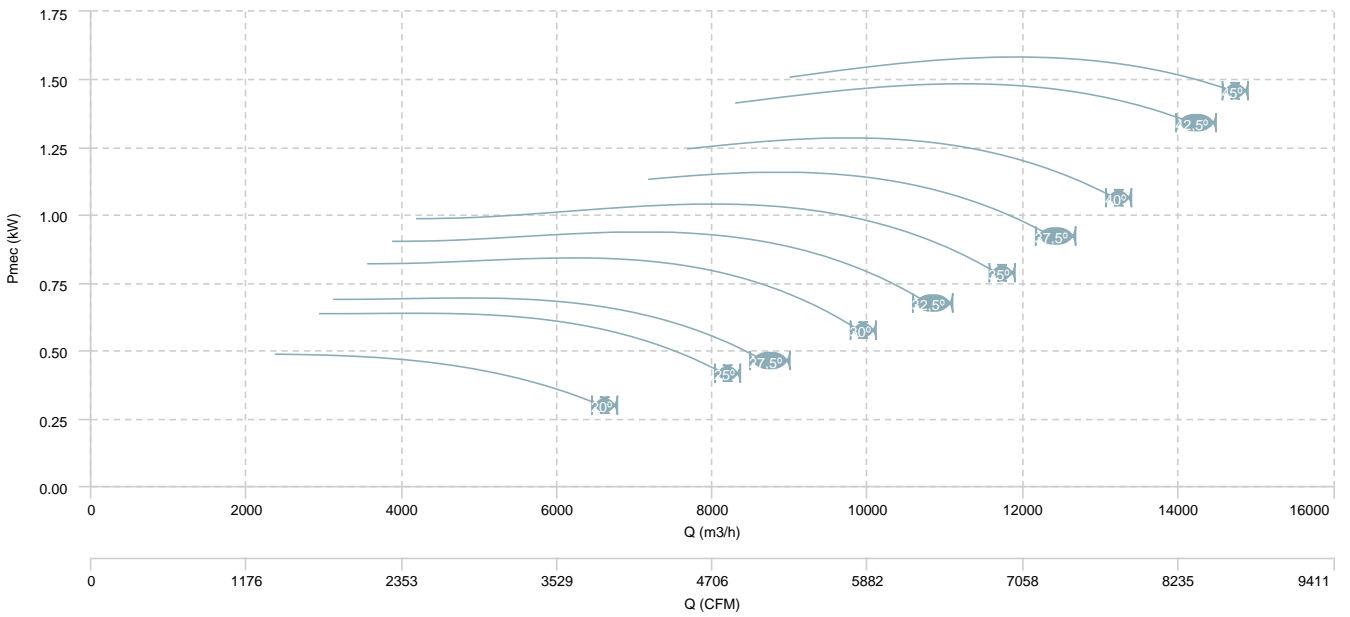

HC 56 M4 (A2:6)

AIR FLOW - PRESSURE

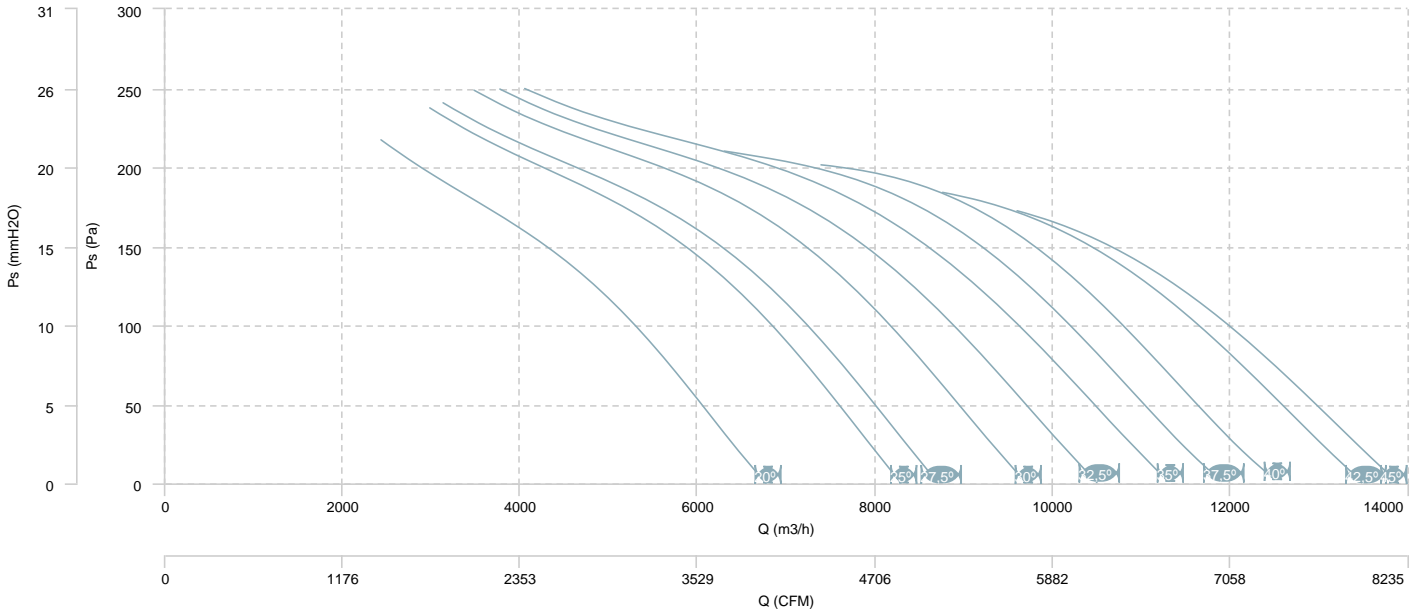

AIR FLOW - MECHANICAL POWER

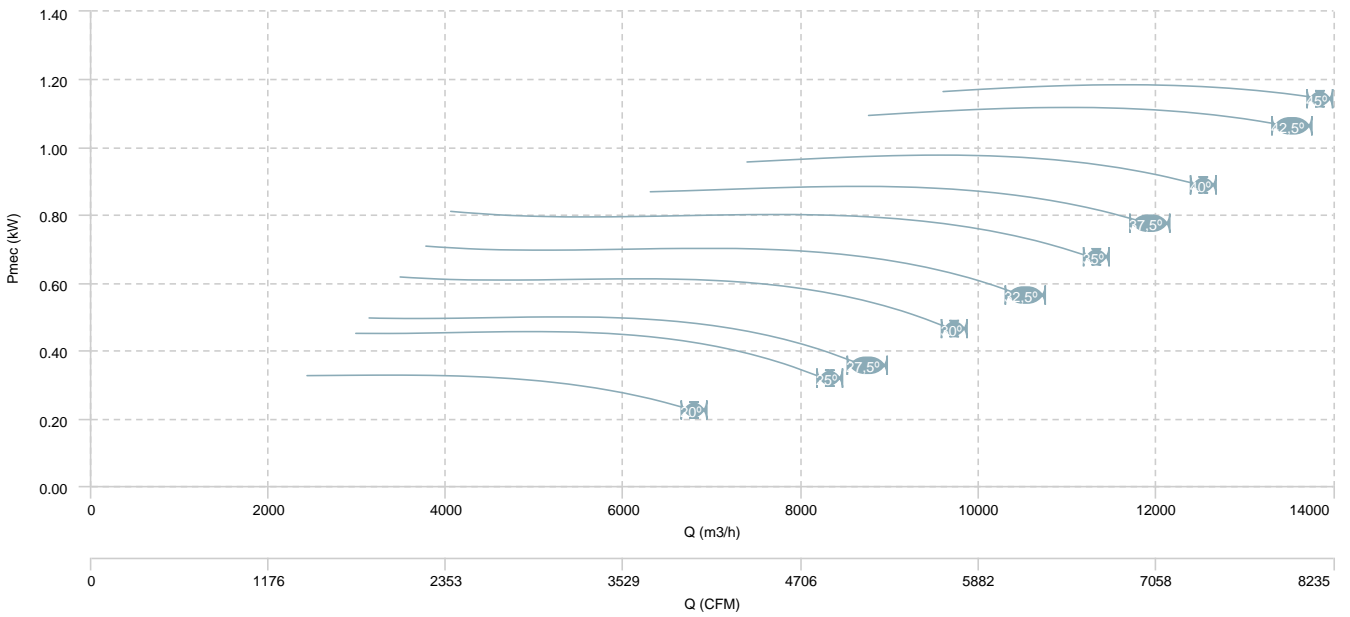

HC 56 M6 (A5:6)

AIR FLOW - PRESSURE

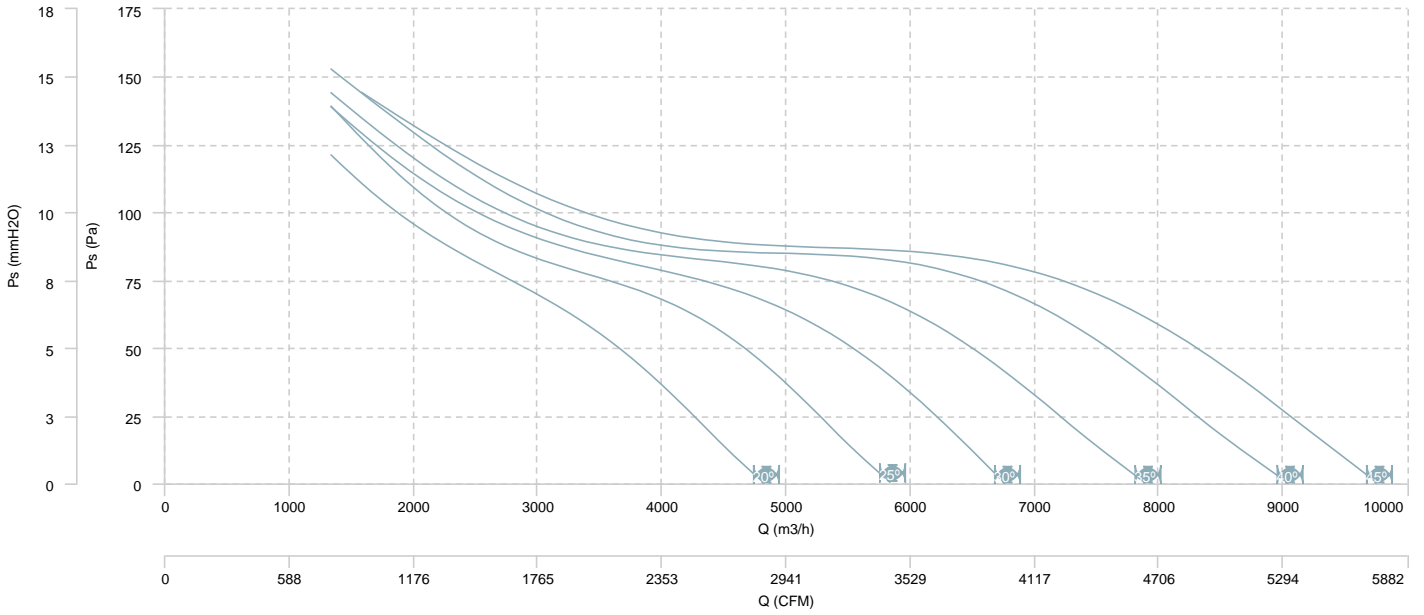

AIR FLOW - MECHANICAL POWER

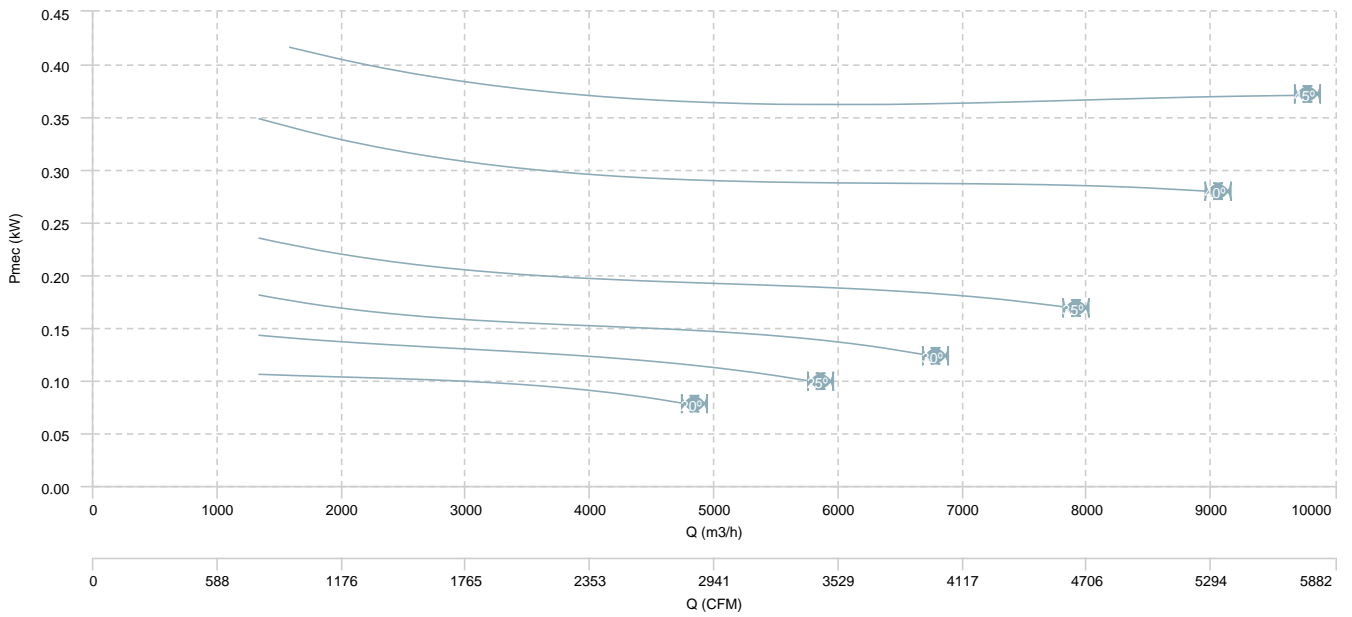

HC 56 M6 (A2:6)

AIR FLOW - PRESSURE

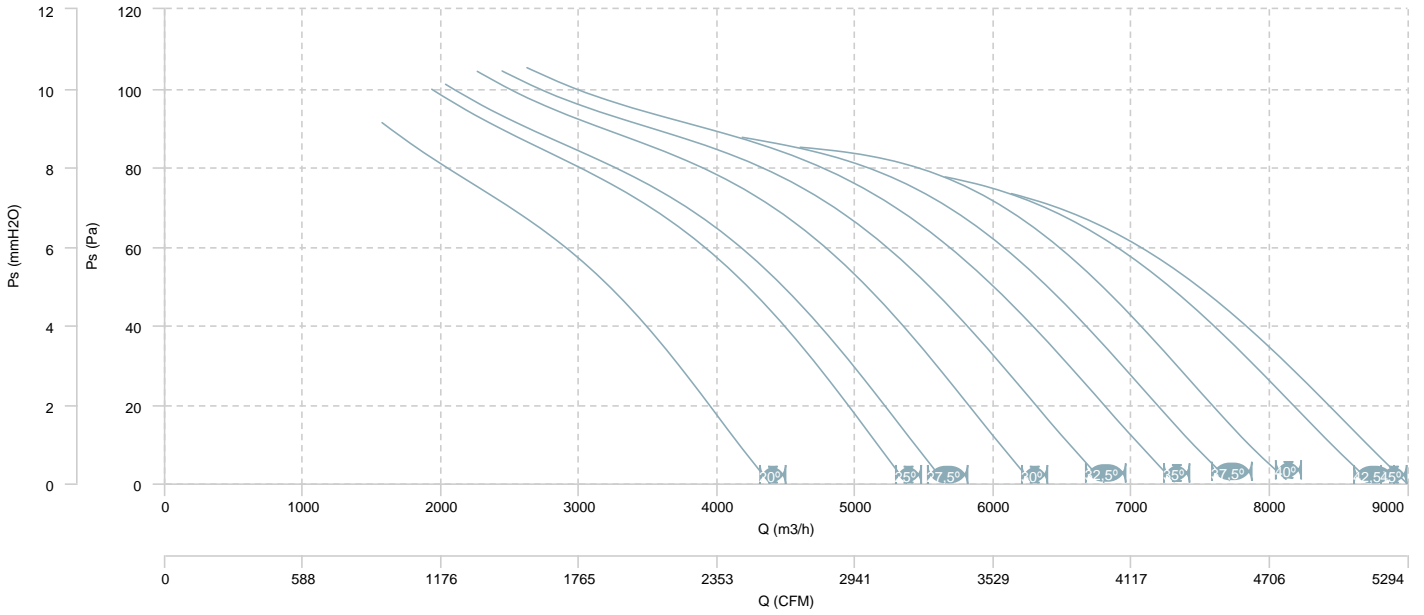

AIR FLOW - MECHANICAL POWER

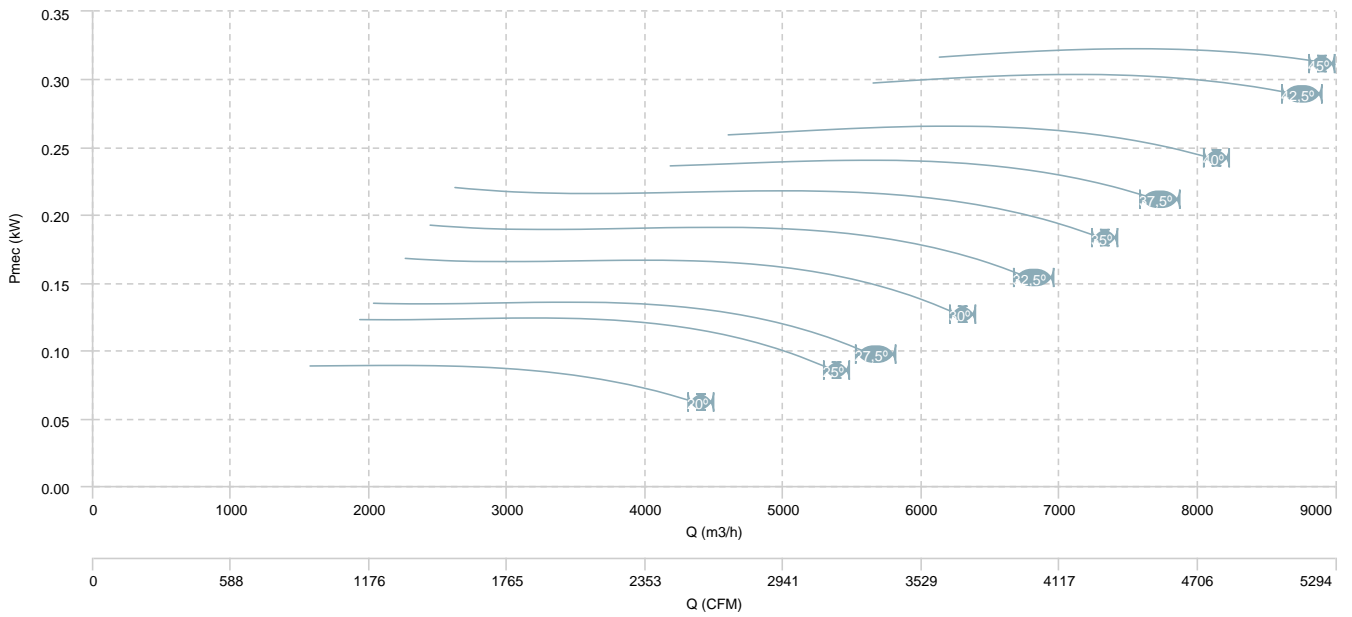

HC 56 M6 (A2:9)

AIR FLOW - PRESSURE

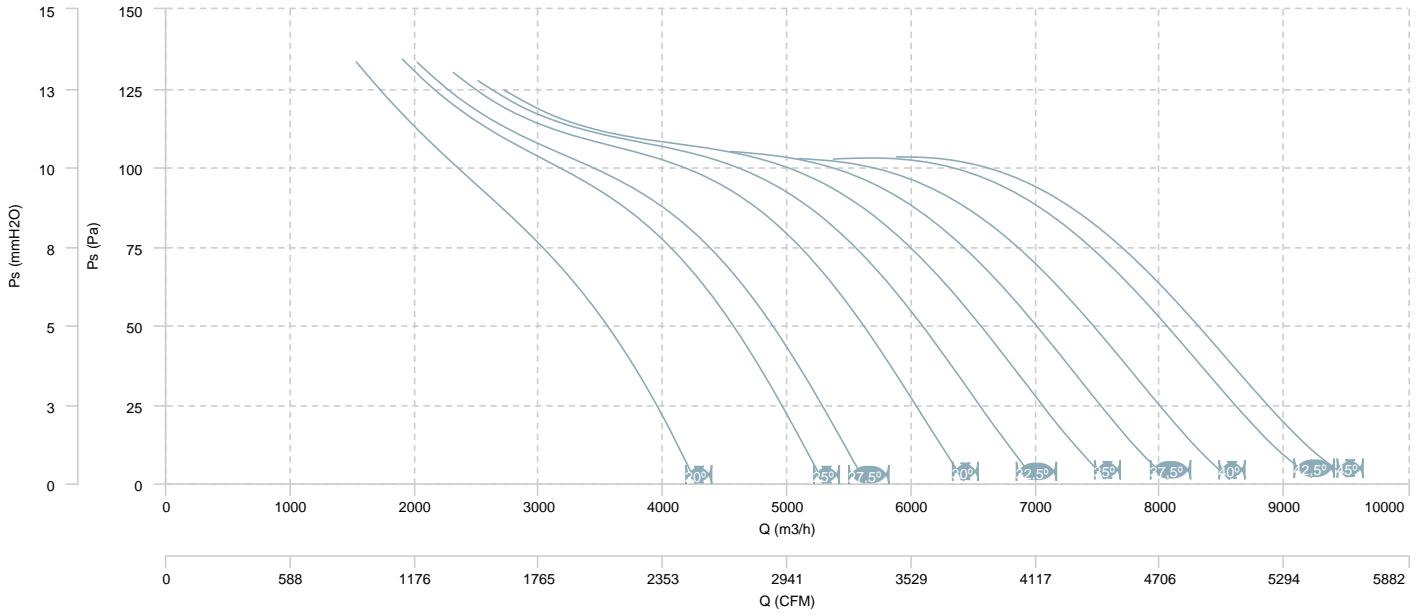

AIR FLOW - MECHANICAL POWER

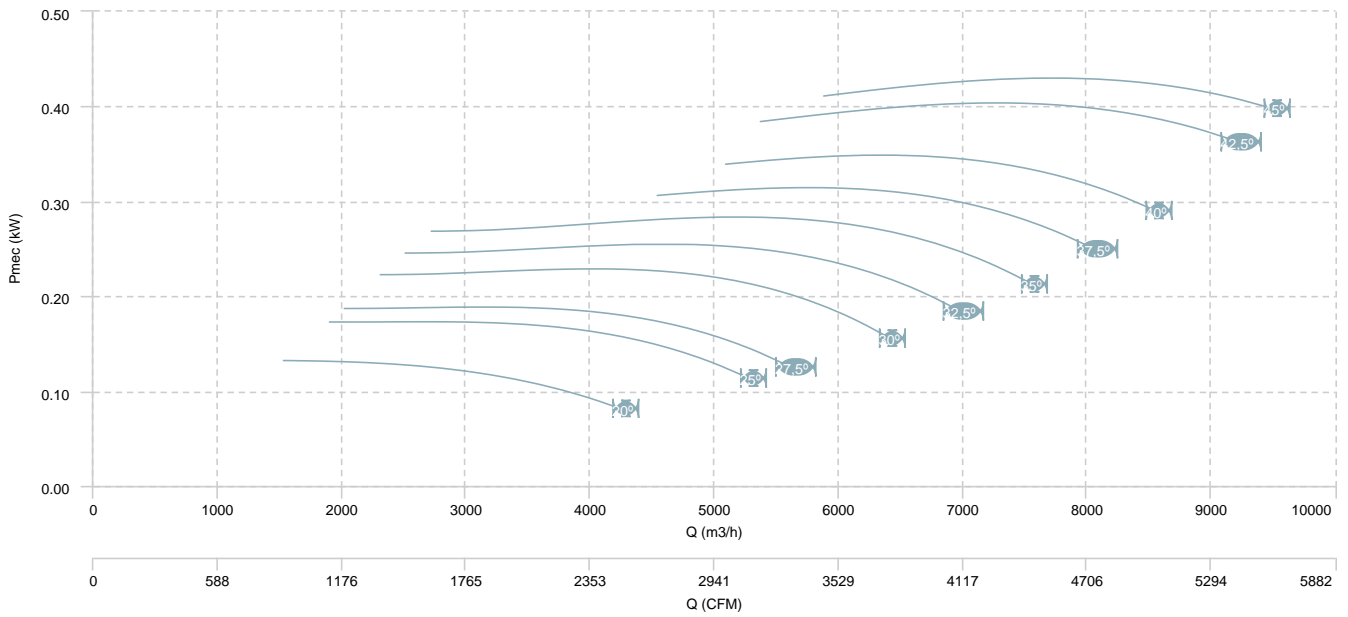

HC 63 M4 (A5:6)

AIR FLOW - PRESSURE

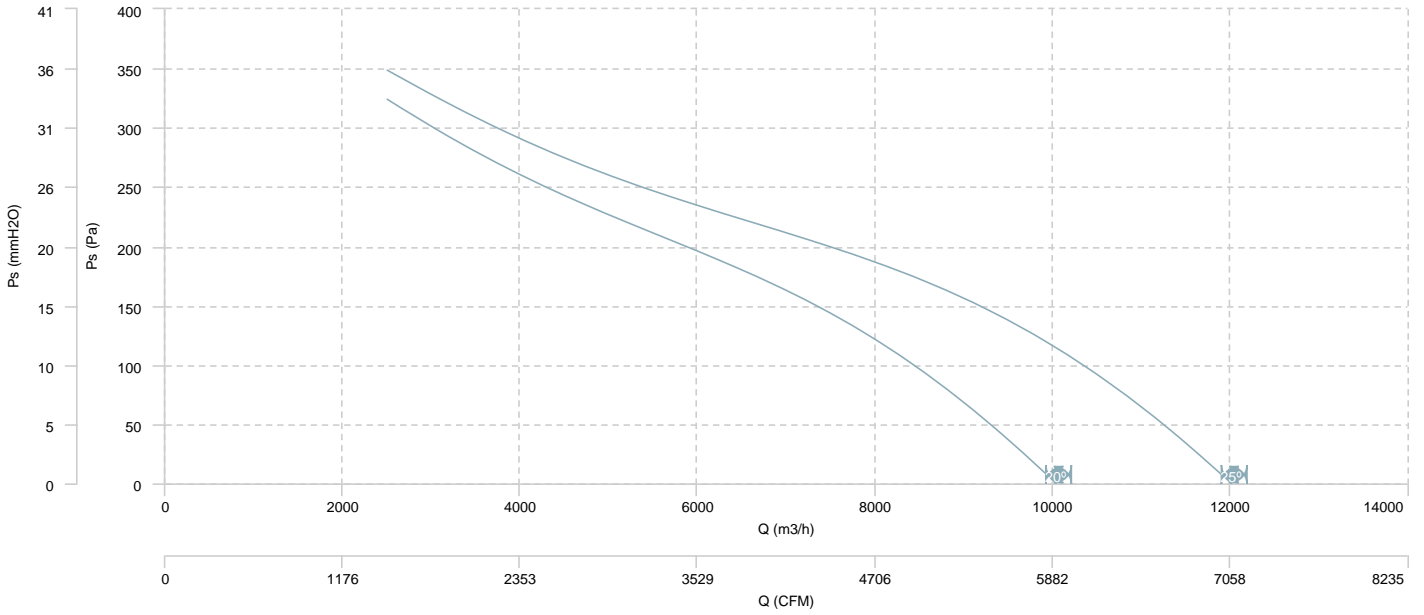

AIR FLOW - MECHANICAL POWER

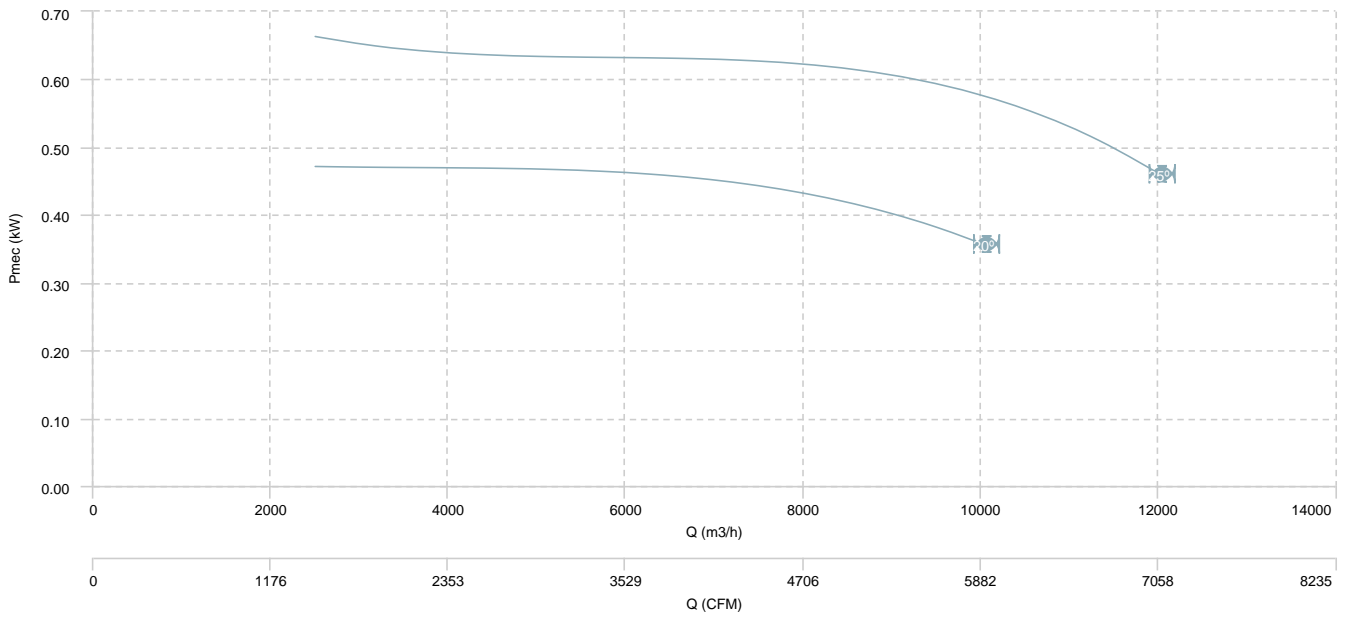

HC 63 M4 (A2:9)

AIR FLOW - PRESSURE

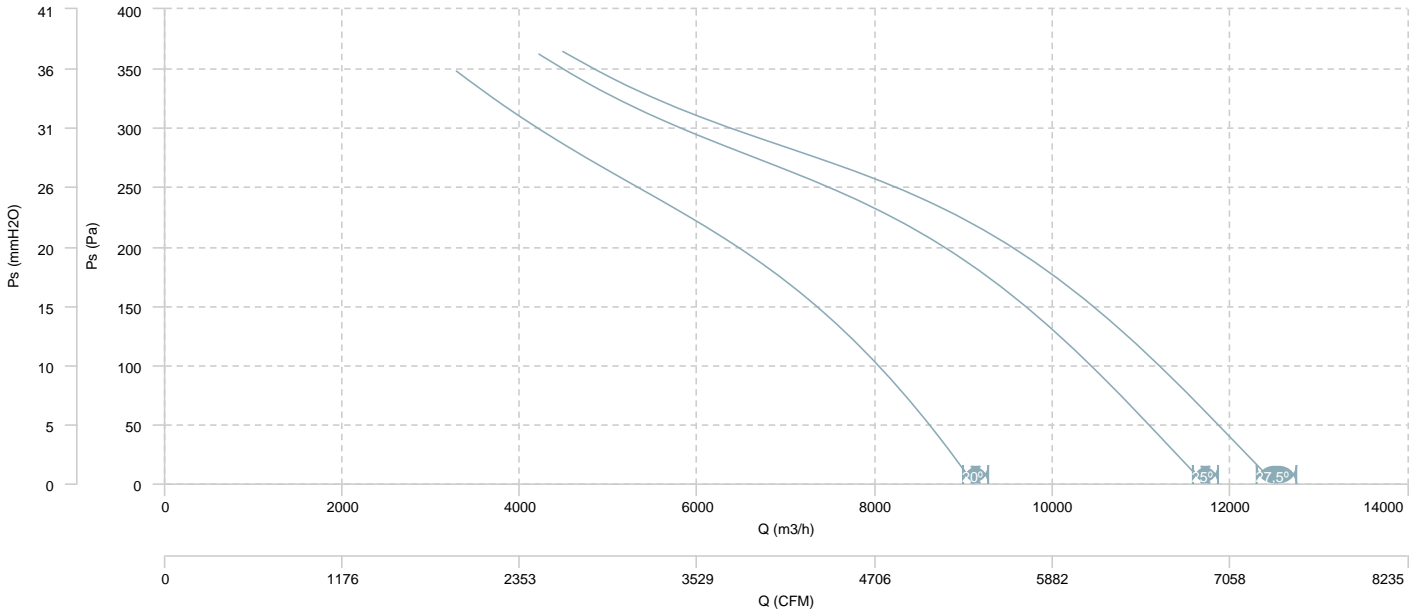

AIR FLOW - MECHANICAL POWER

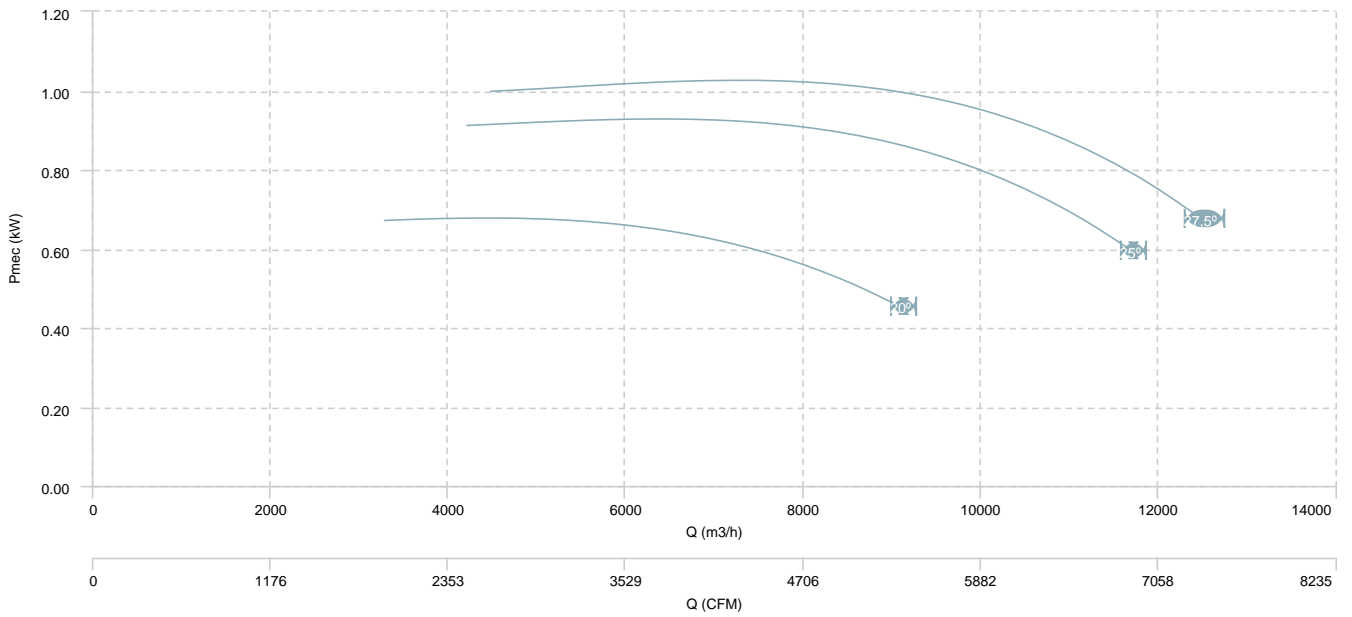

HC 63 M4 (A2:6)

AIR FLOW - PRESSURE

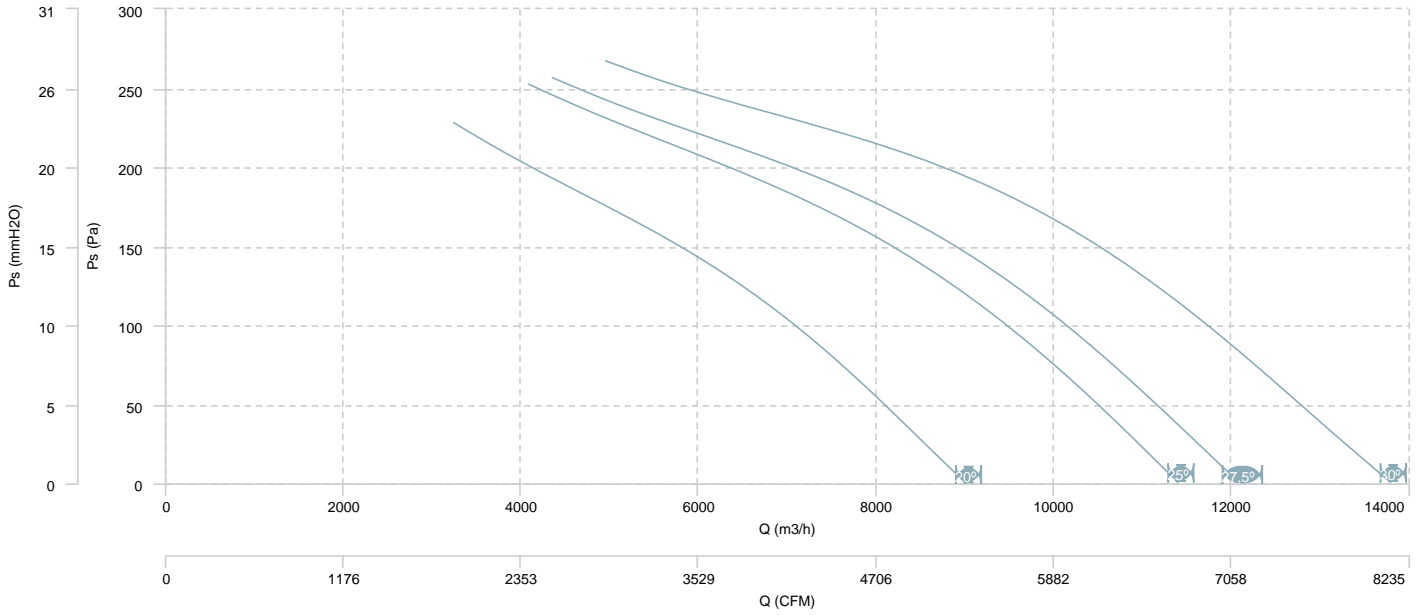

AIR FLOW - MECHANICAL POWER

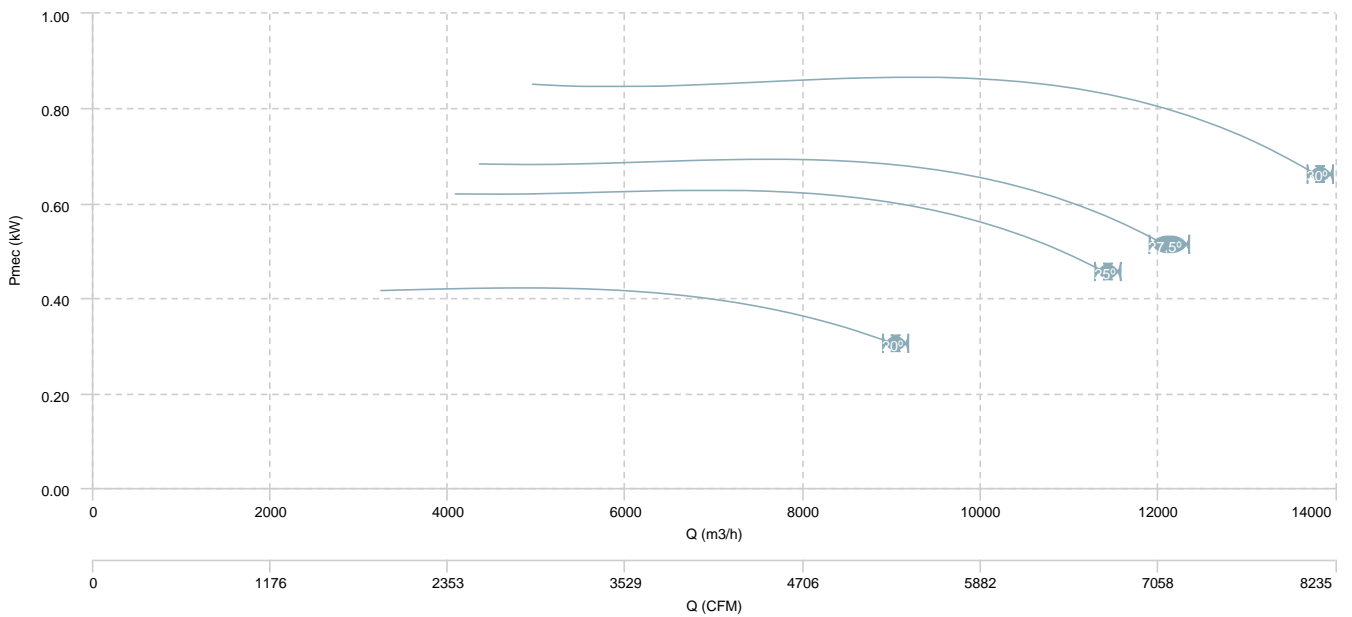

HC 63 M6 (A2:6)

AIR FLOW - PRESSURE

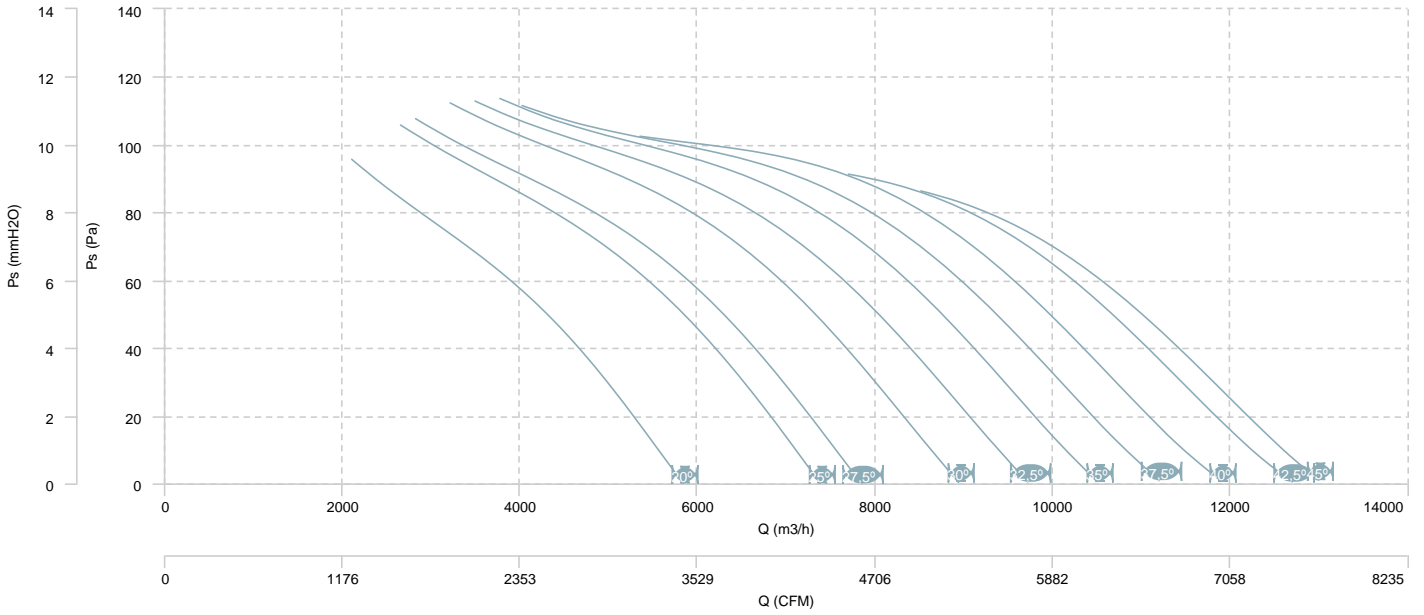

AIR FLOW - MECHANICAL POWER

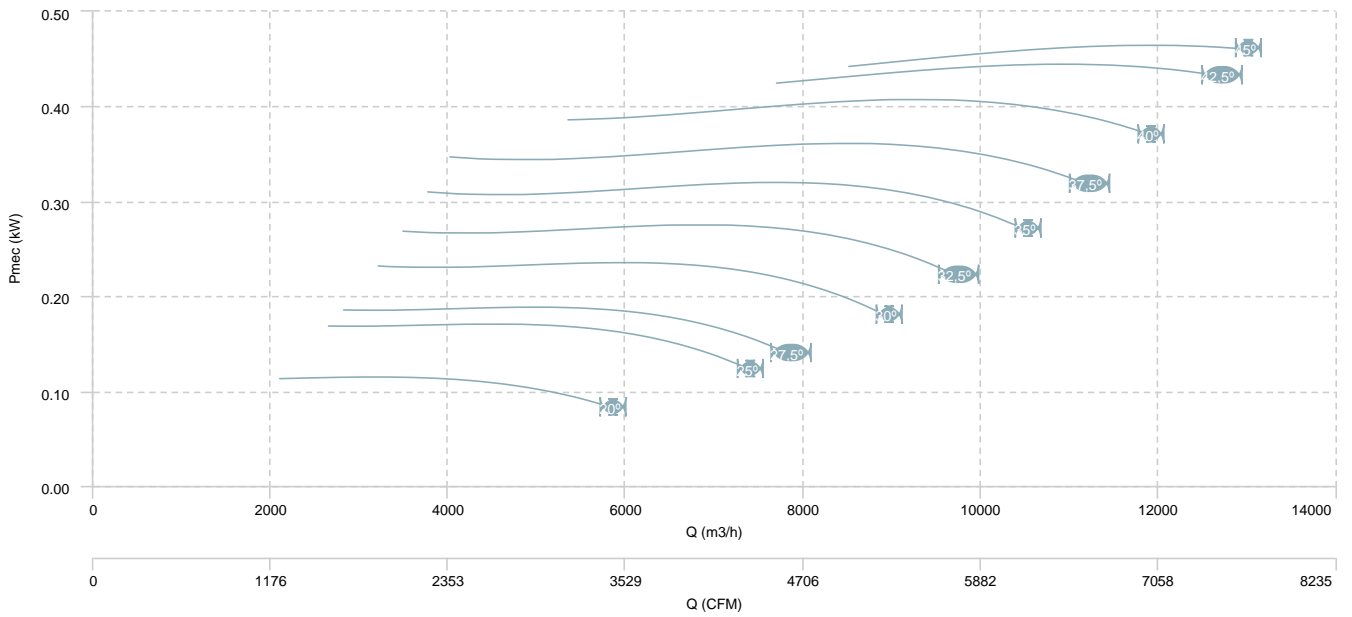

HC 63 M6 (A5:6)

AIR FLOW - PRESSURE

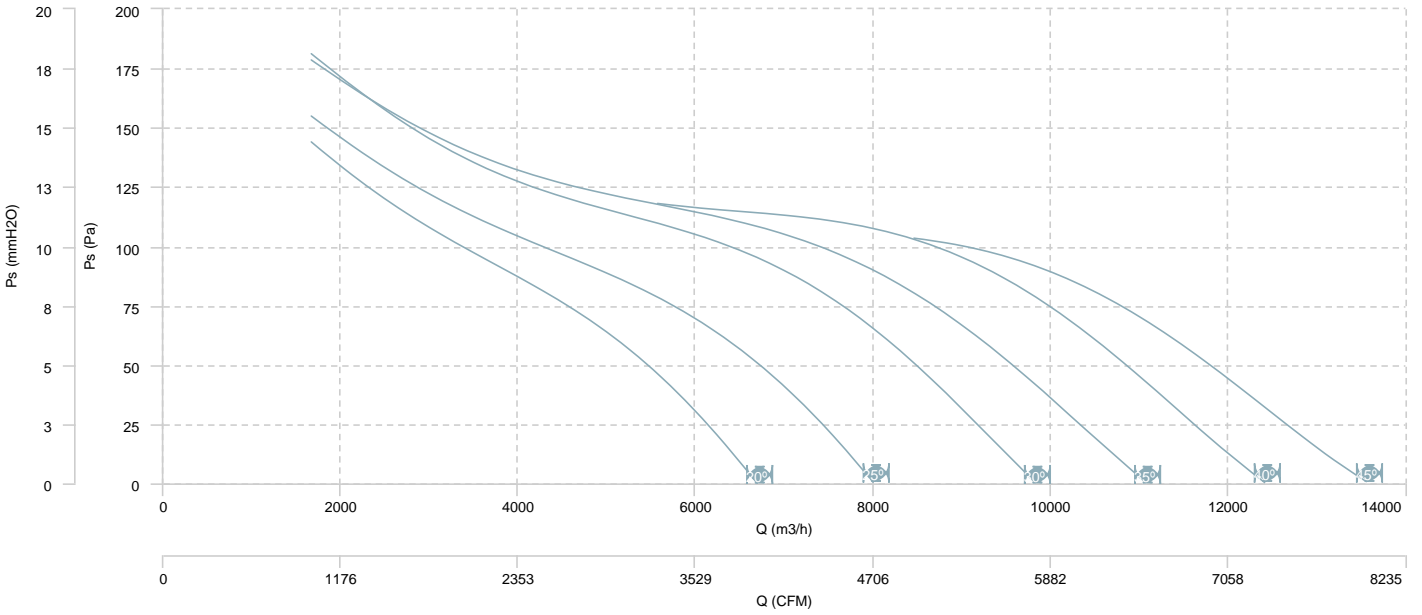

AIR FLOW - MECHANICAL POWER

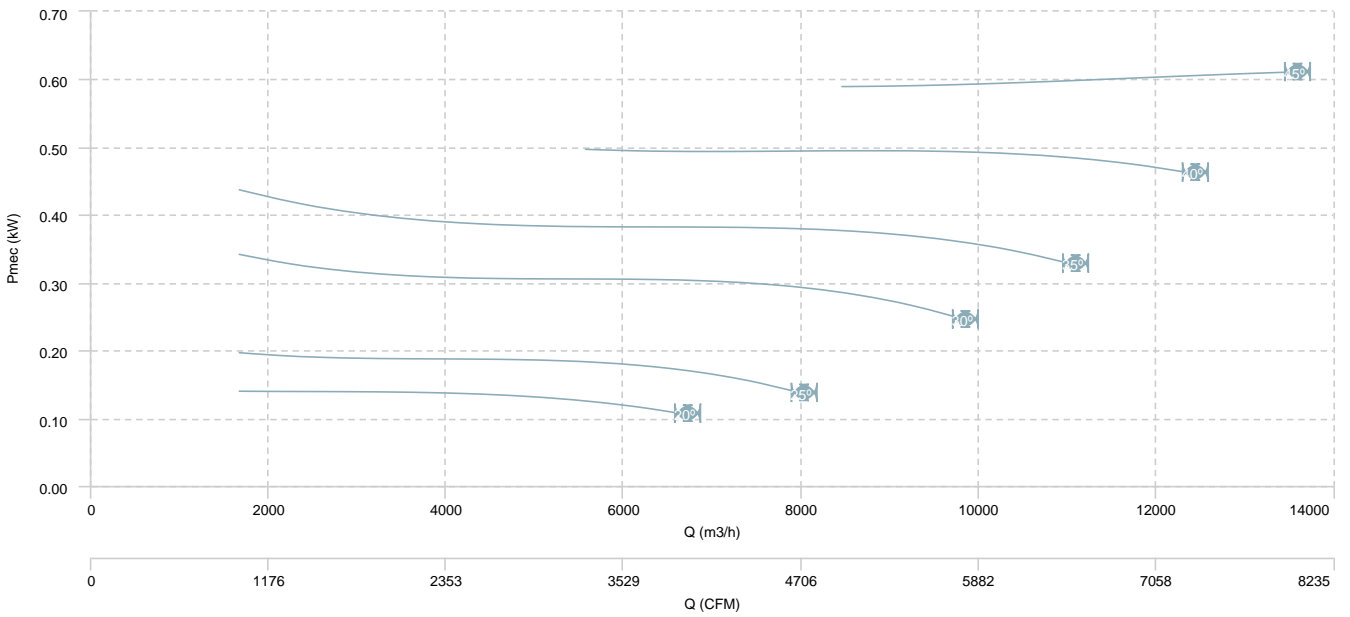

HC 63 M6 (A2:9)

AIR FLOW - PRESSURE

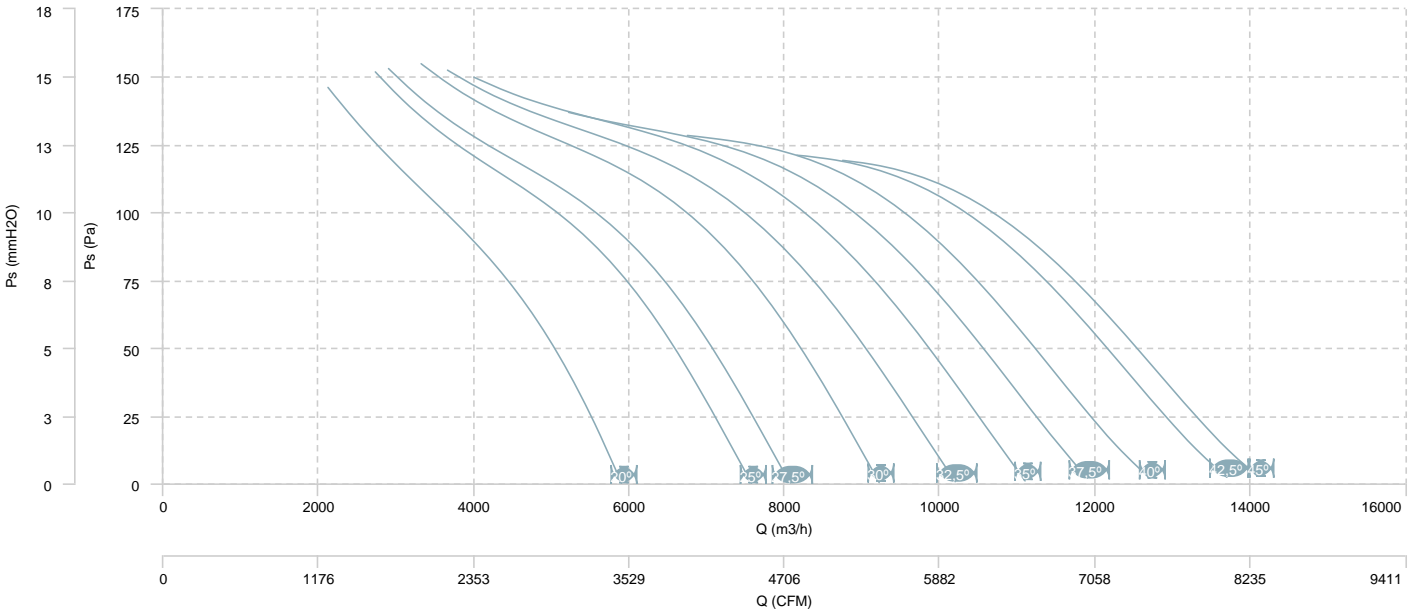

AIR FLOW - MECHANICAL POWER

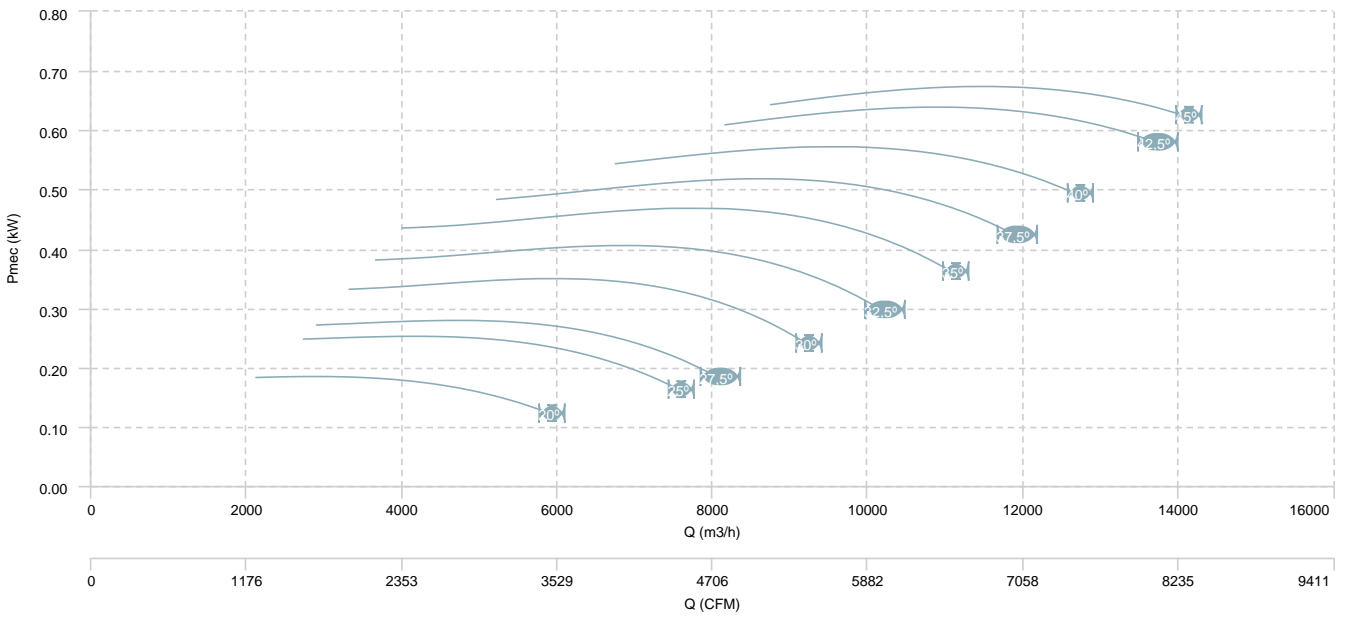

HC 71 M4 (A2:6)

AIR FLOW - PRESSURE

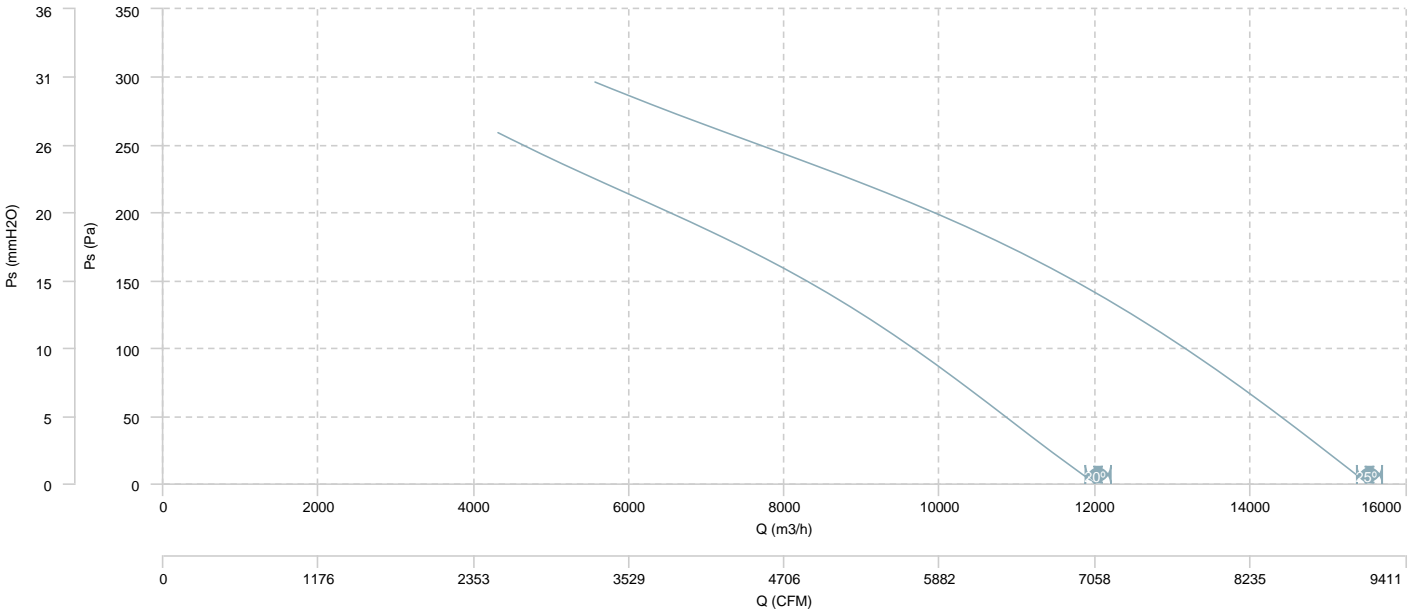

AIR FLOW - MECHANICAL POWER

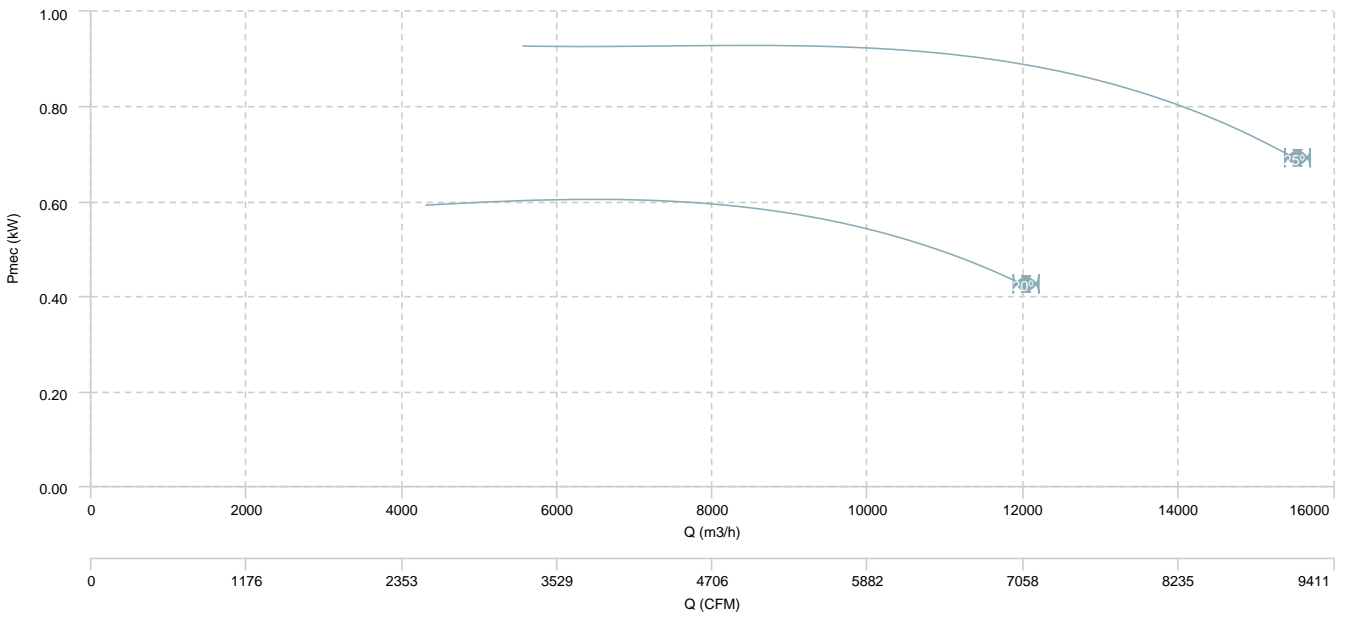

HC 71 M4 (A2:9)

AIR FLOW - PRESSURE

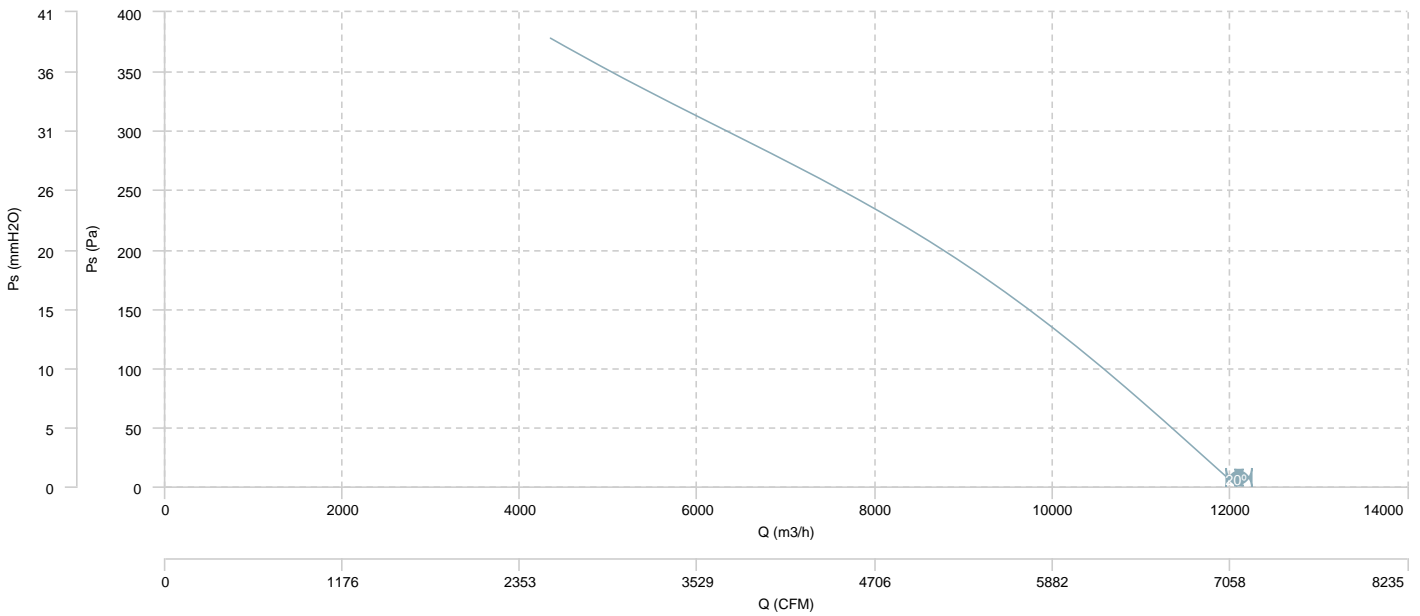

AIR FLOW - MECHANICAL POWER

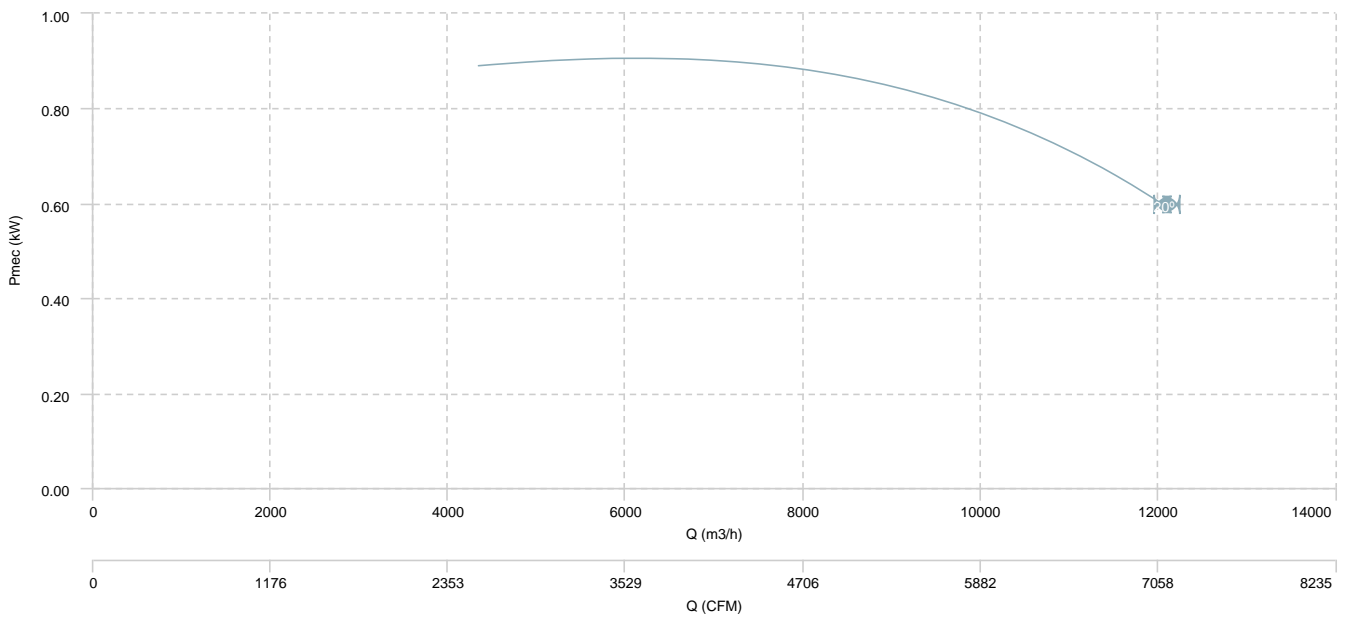

HC 71 M4 (A5:6)

AIR FLOW - PRESSURE

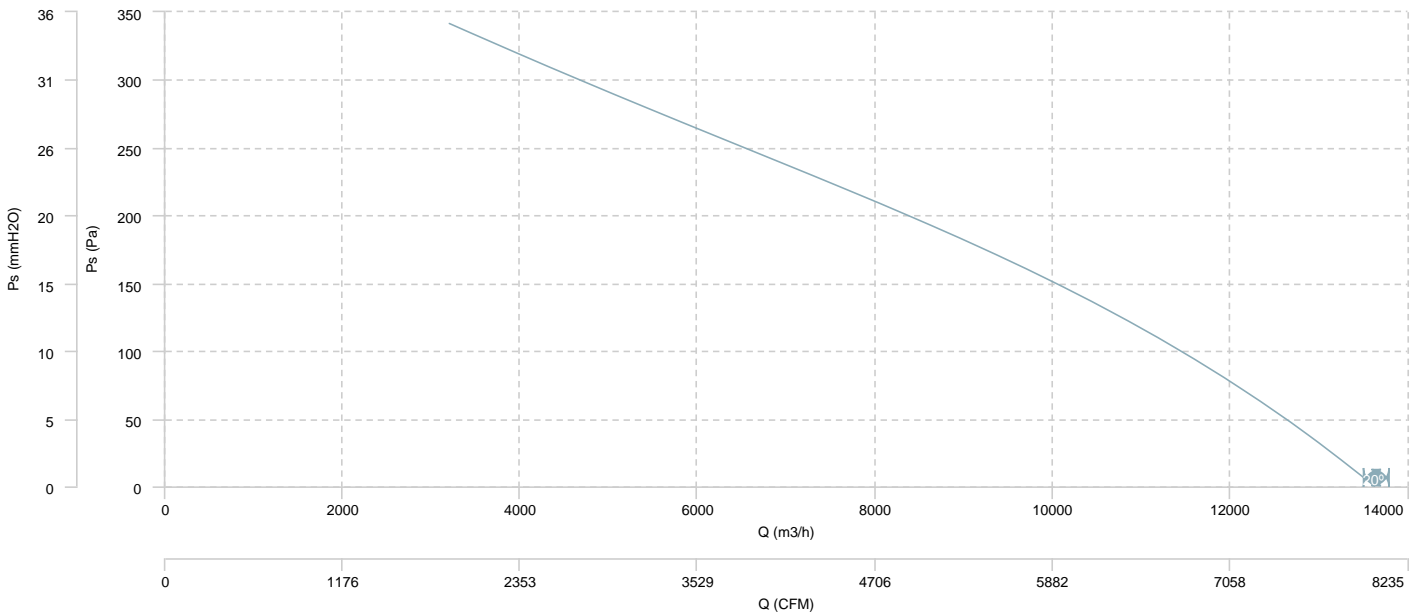

AIR FLOW - MECHANICAL POWER

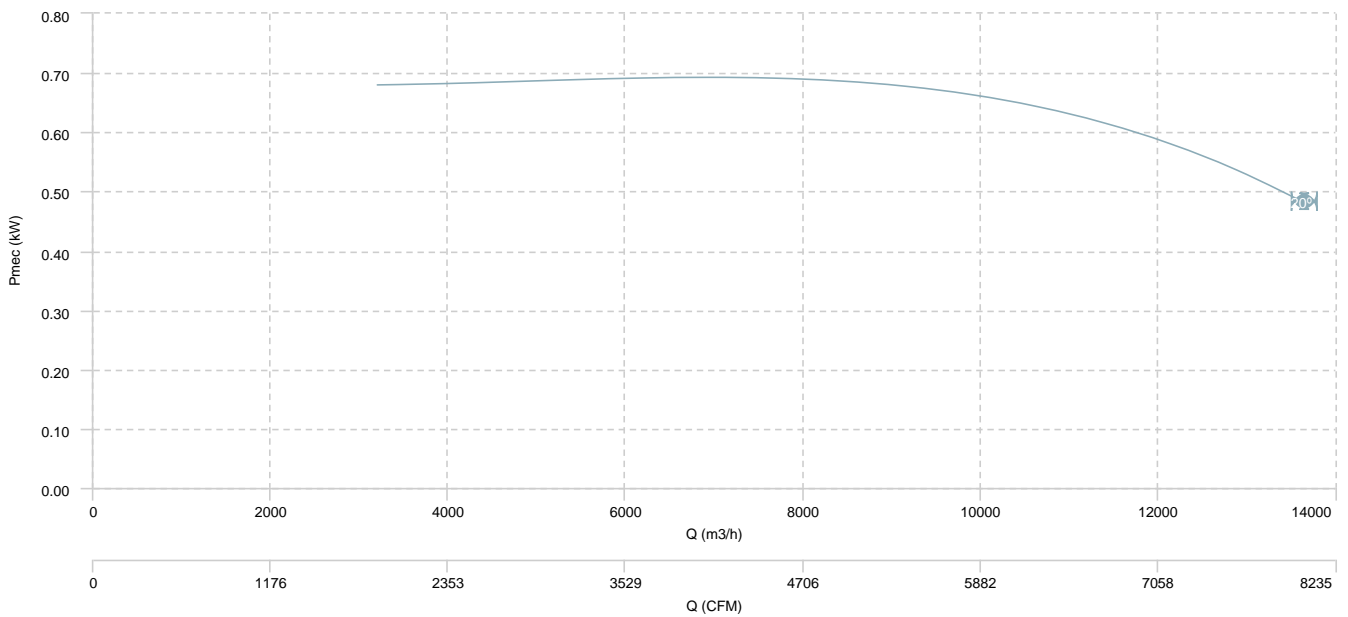

HC 71 M6 (A5:6)

AIR FLOW - PRESSURE

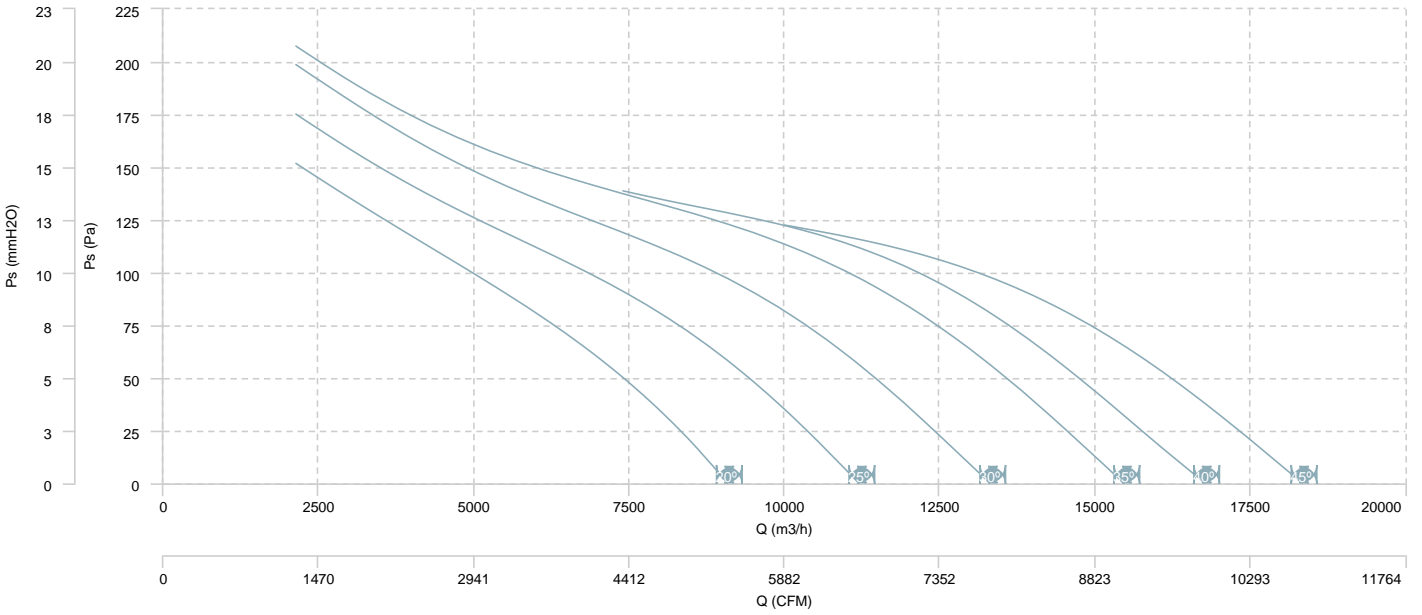

AIR FLOW - MECHANICAL POWER

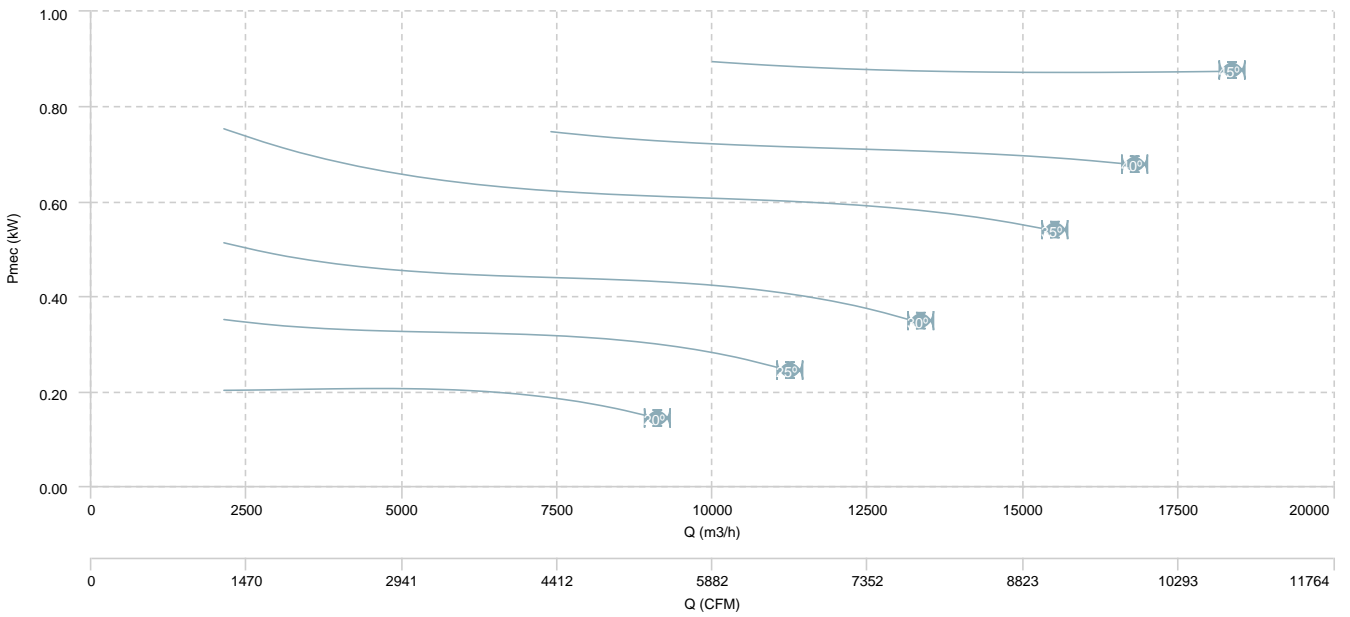

HC 71 M6 (A2:6)

AIR FLOW - PRESSURE

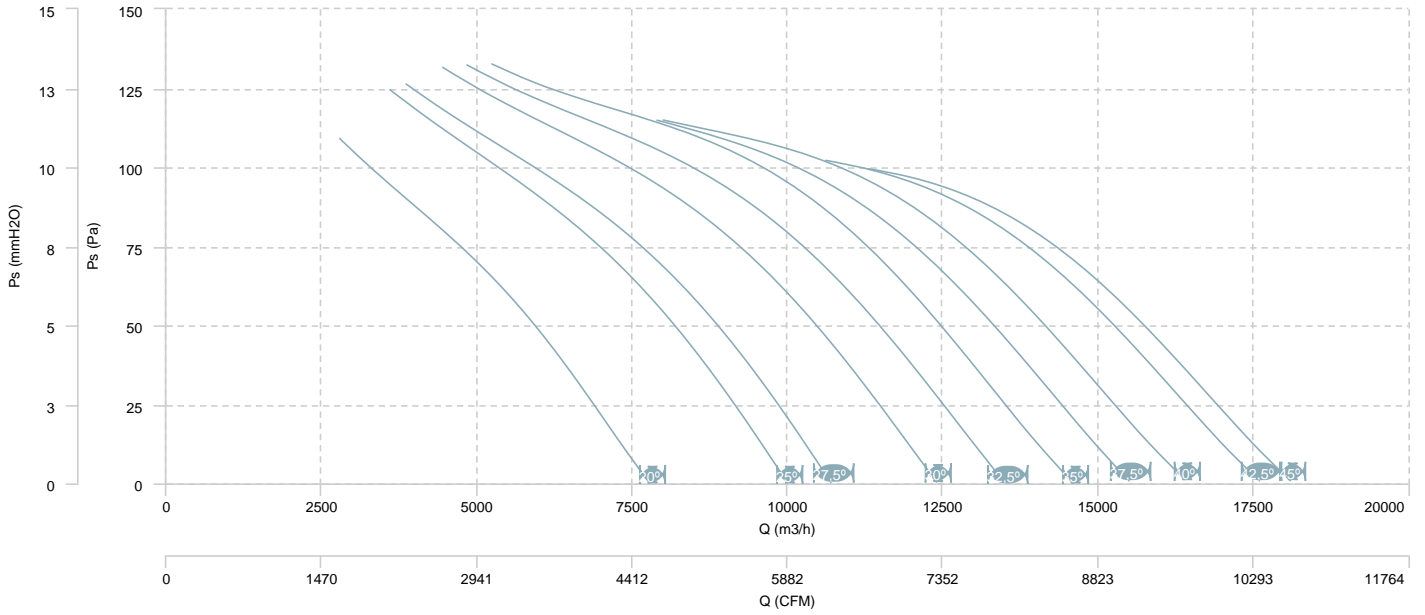

AIR FLOW - MECHANICAL POWER

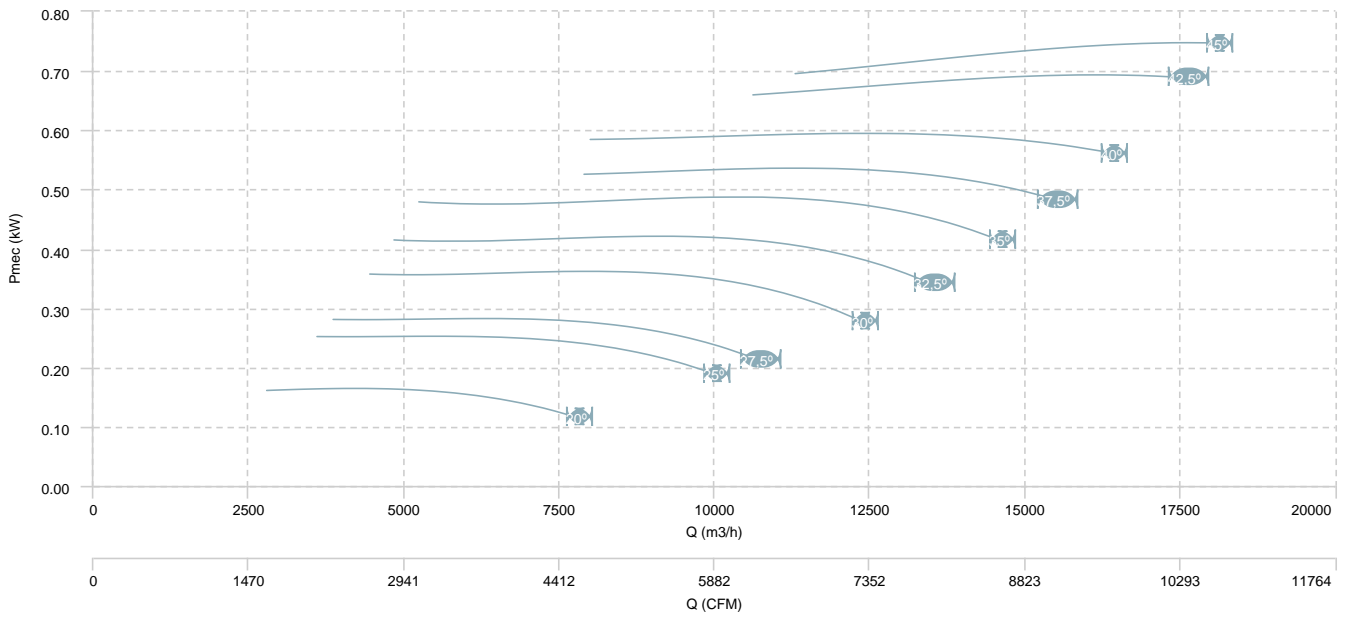

HC 71 M6 (A2:9)

AIR FLOW - PRESSURE

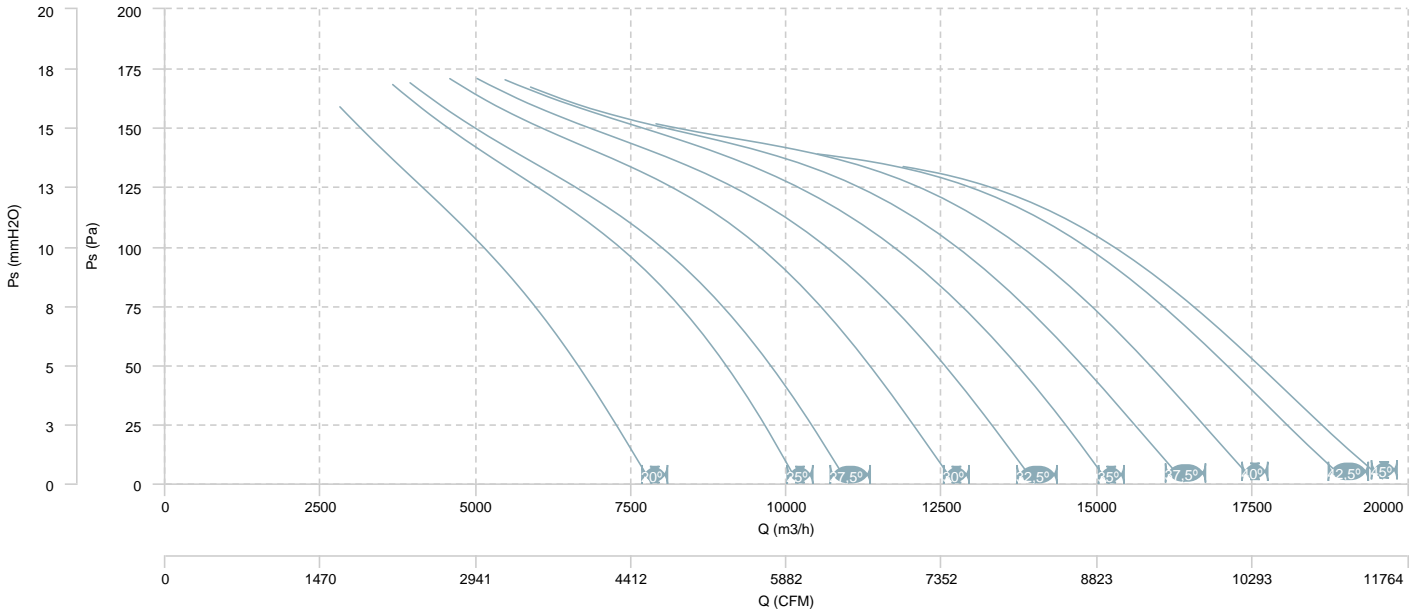

AIR FLOW - MECHANICAL POWER

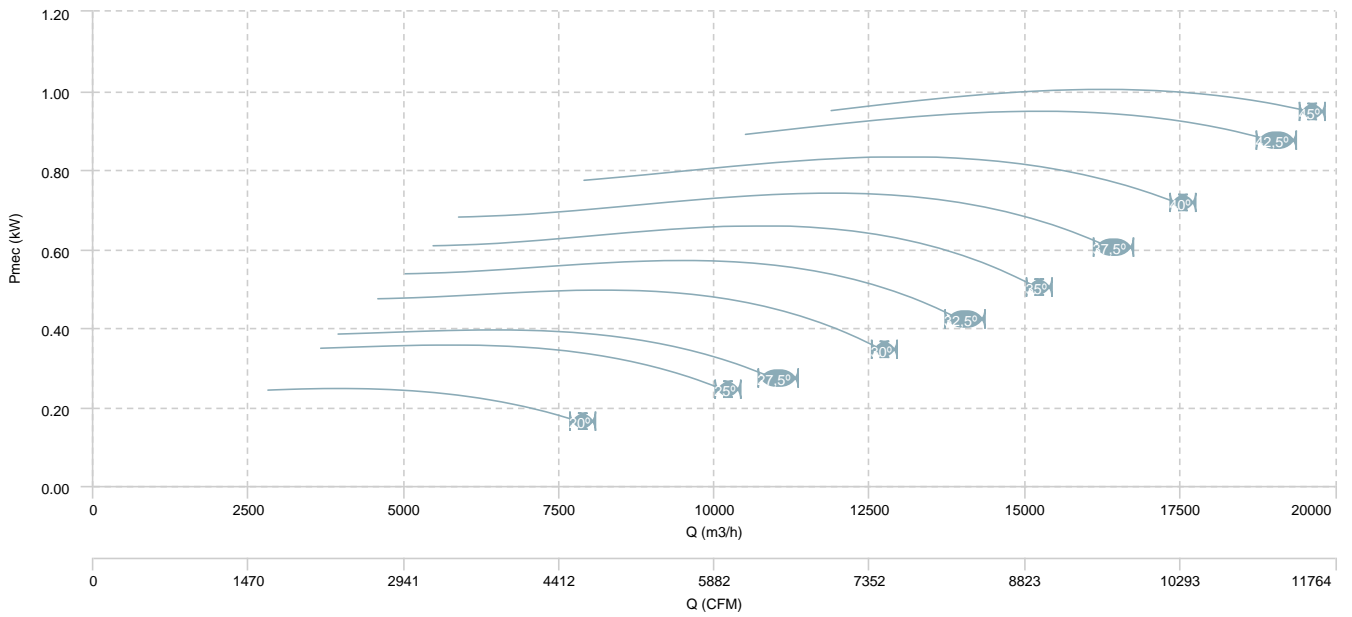

HC 35 T4 (A0:6)

AIR FLOW - PRESSURE

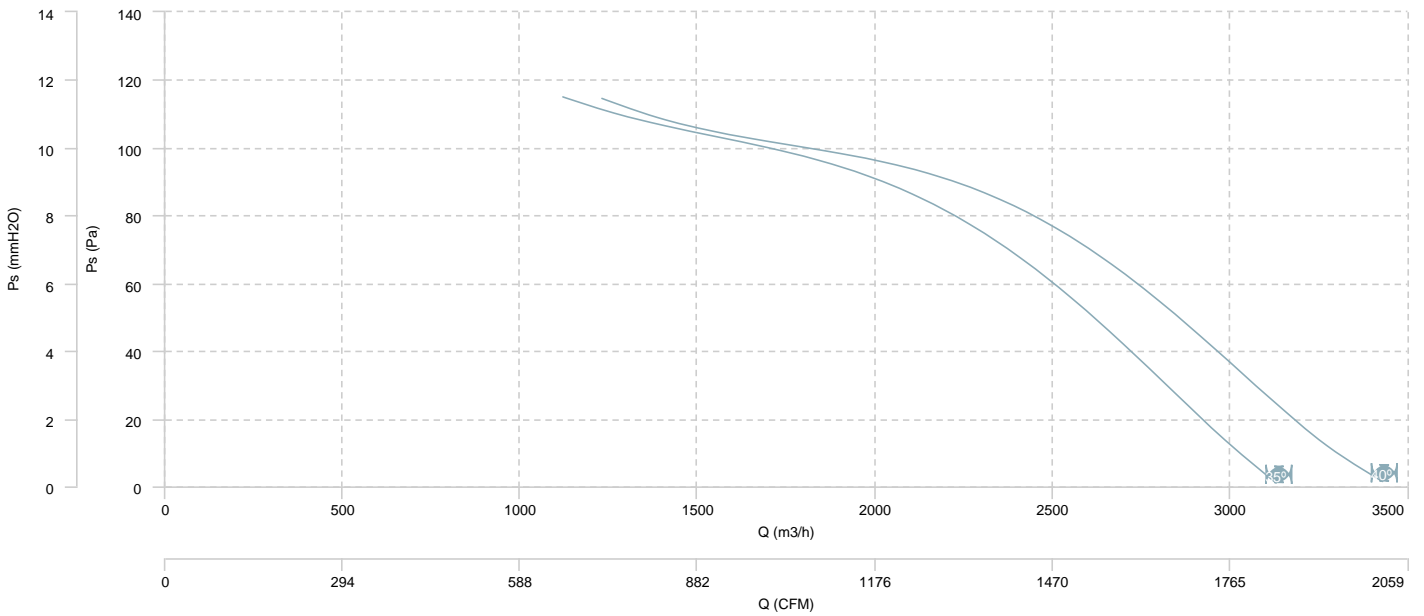

AIR FLOW - MECHANICAL POWER

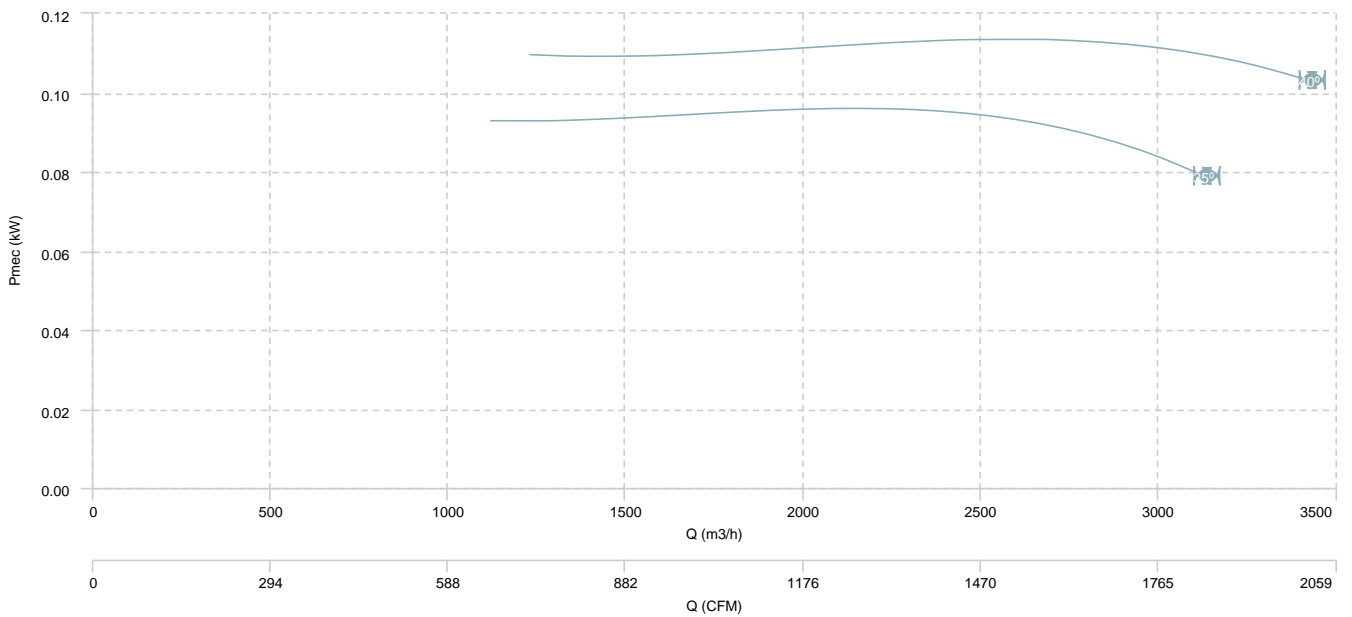

HC 35 T6 (A0:6)

AIR FLOW - PRESSURE

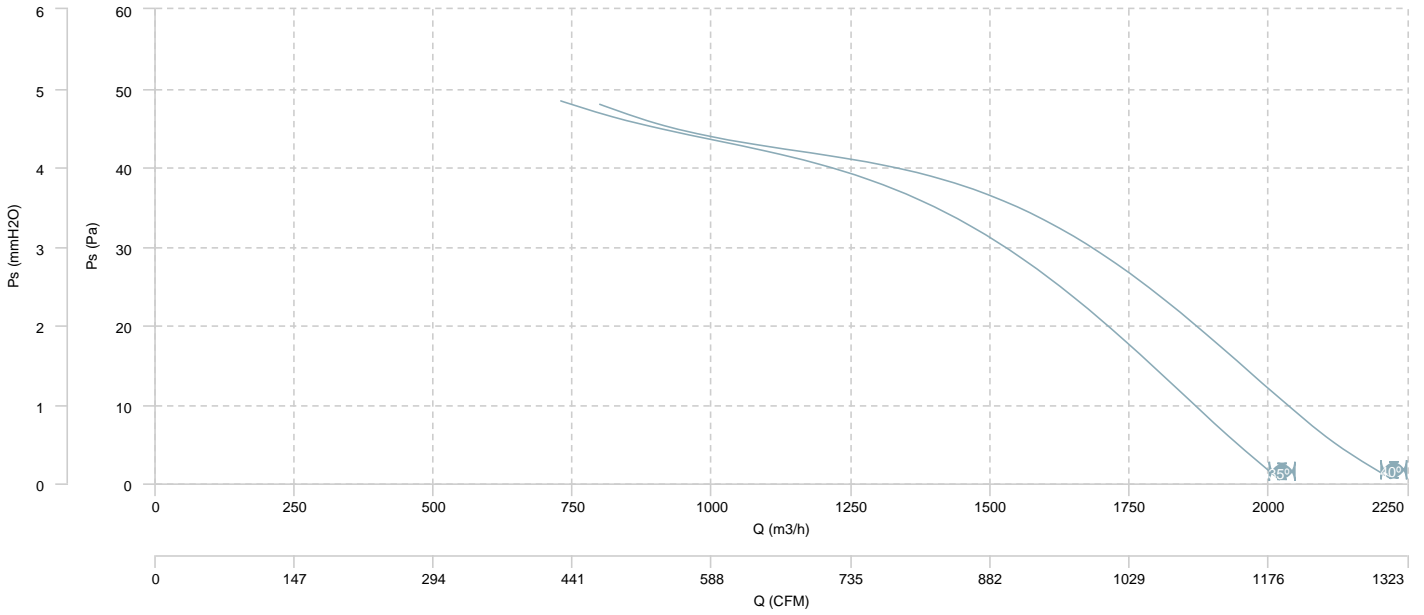

AIR FLOW - MECHANICAL POWER

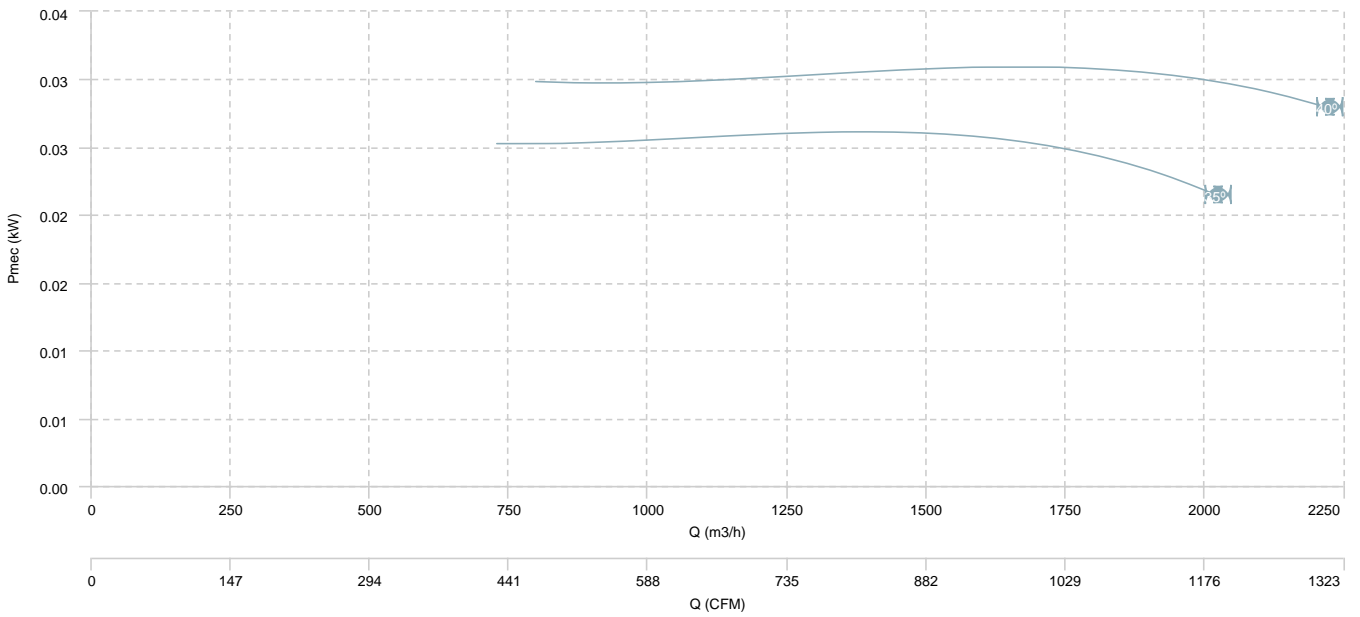

HC 35 T4/T8 (A0:6)

AIR FLOW - PRESSURE (4 poles)

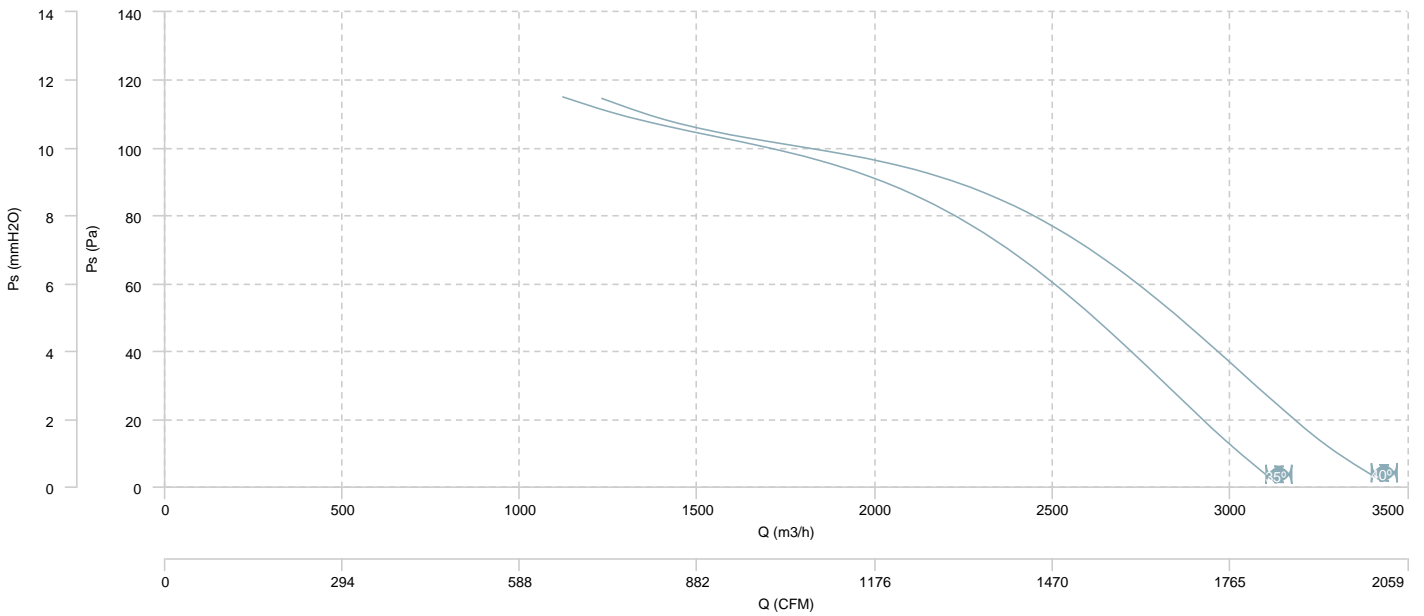

AIR FLOW - MECHANICAL POWER (4 poles)

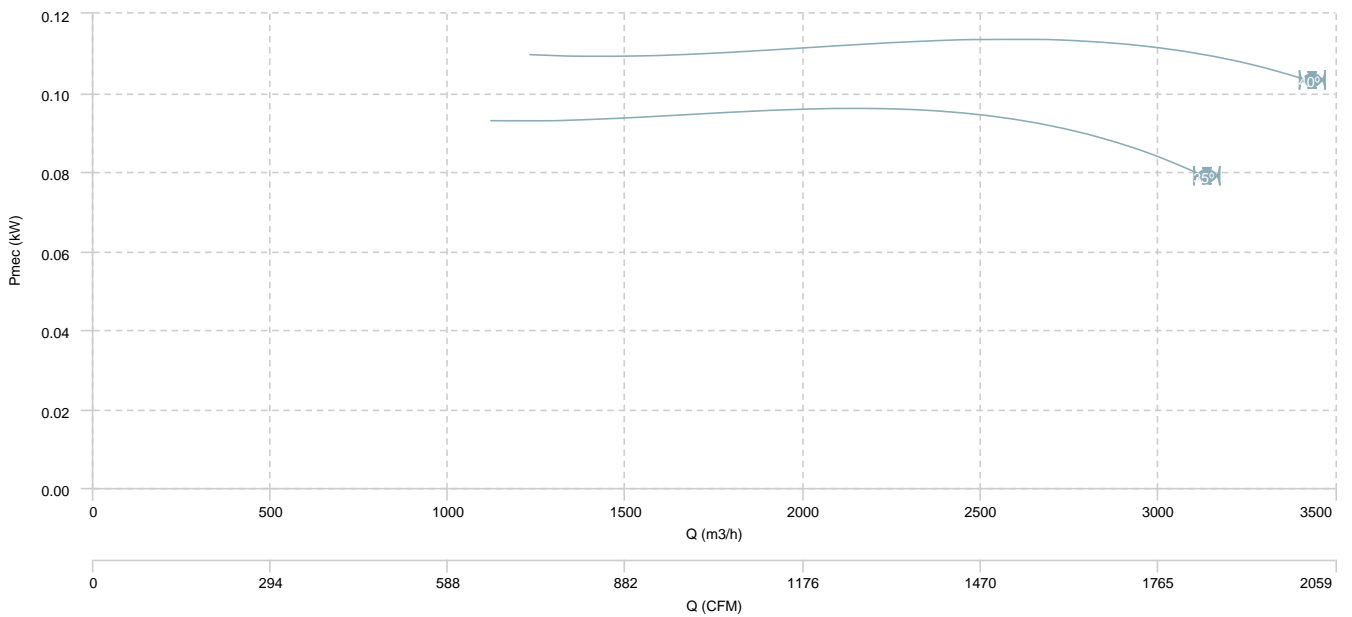

HC 35 T4/T8 (A0:6)

AIR FLOW - PRESSURE (8 poles)

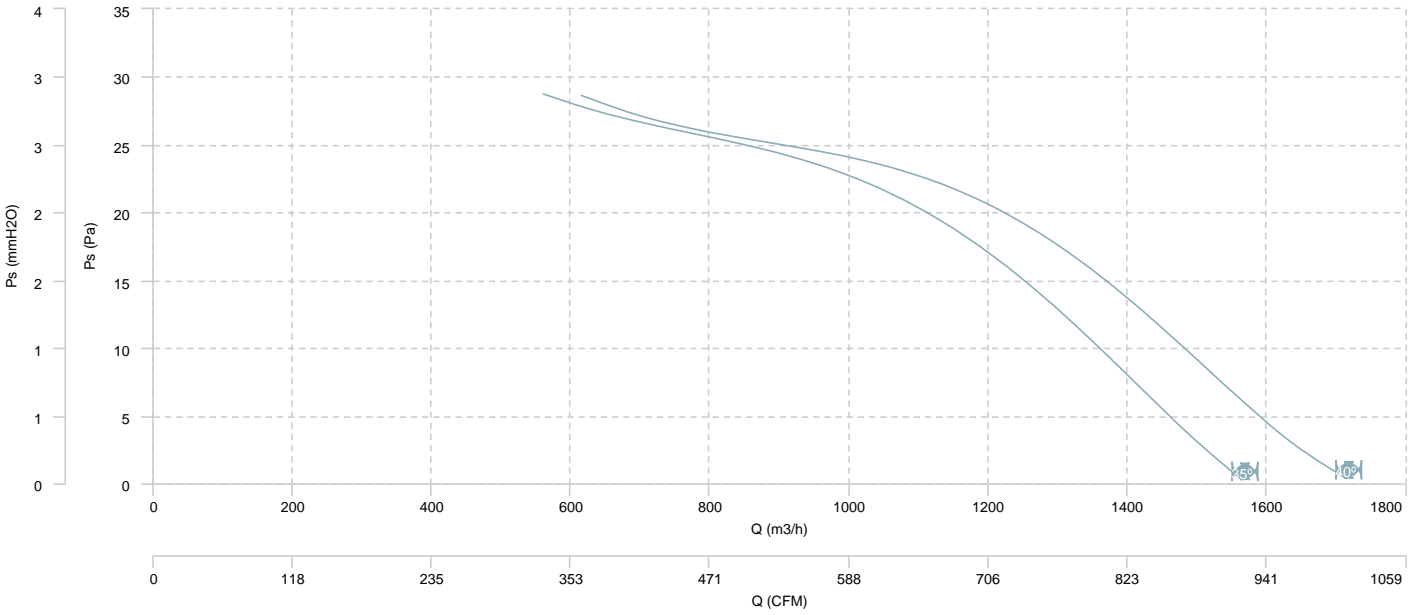

AIR FLOW - MECHANICAL POWER (8 poles)

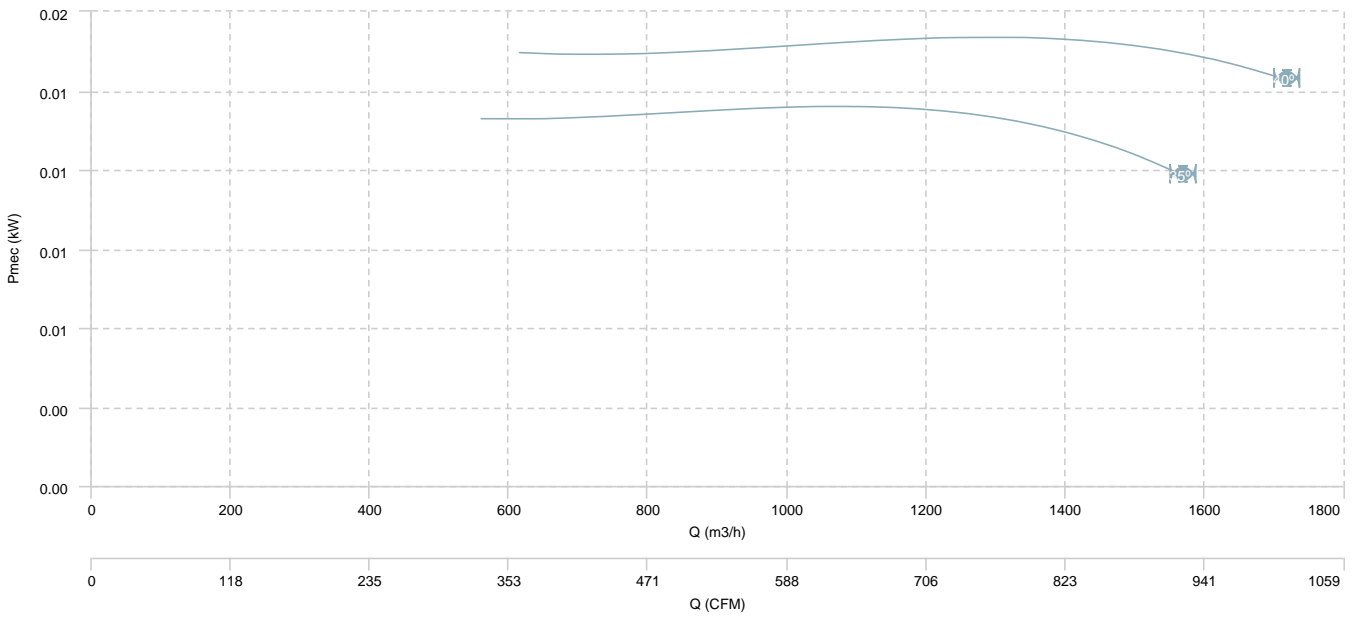

HC 40 T4 (A0:6)

AIR FLOW - PRESSURE

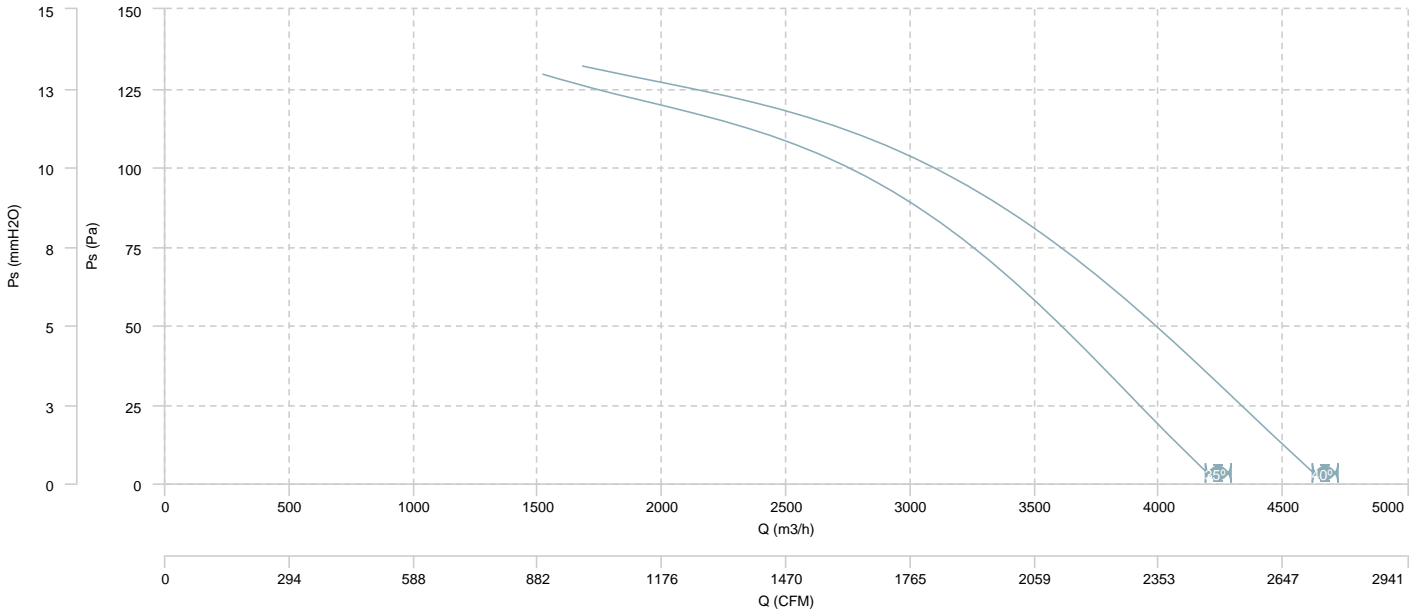

AIR FLOW - MECHANICAL POWER

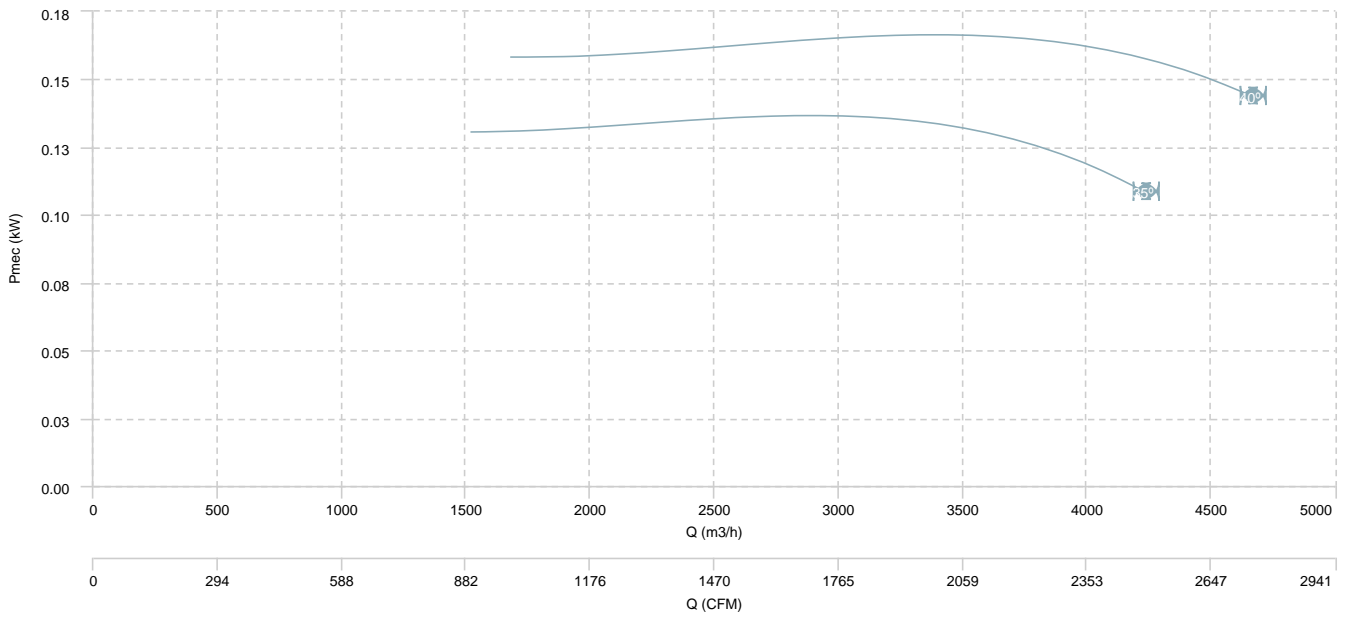

HC 40 T6 (A0:6)

AIR FLOW - PRESSURE

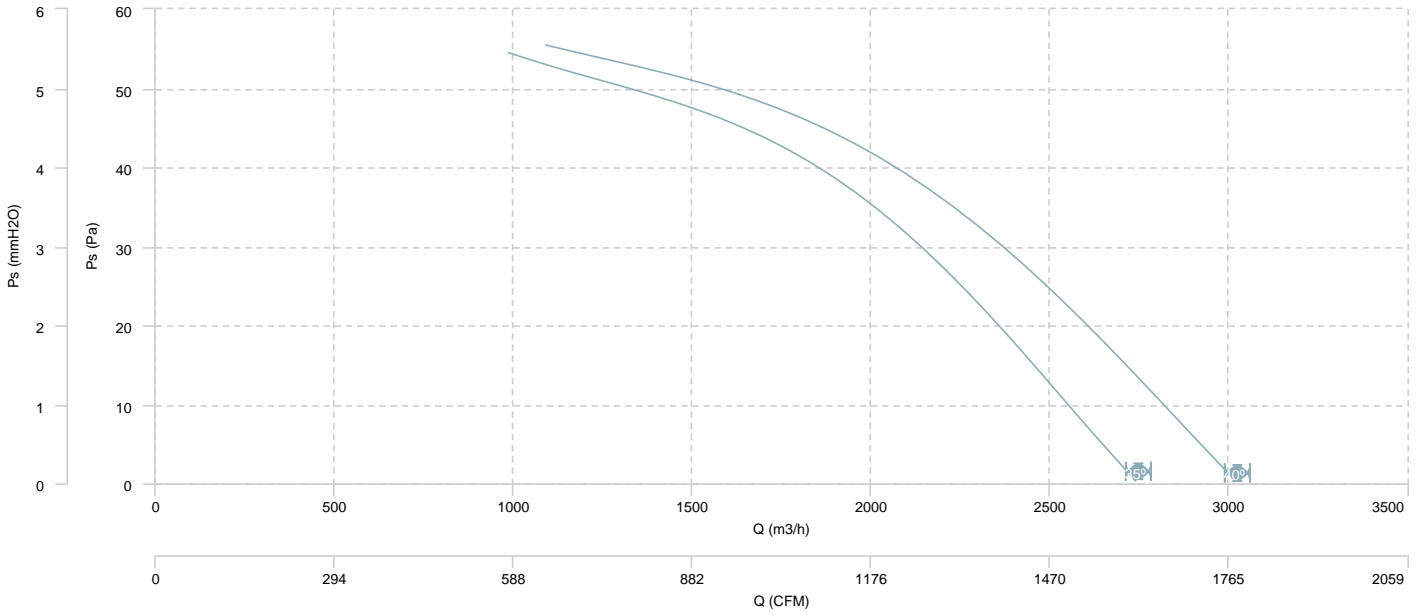

AIR FLOW - MECHANICAL POWER

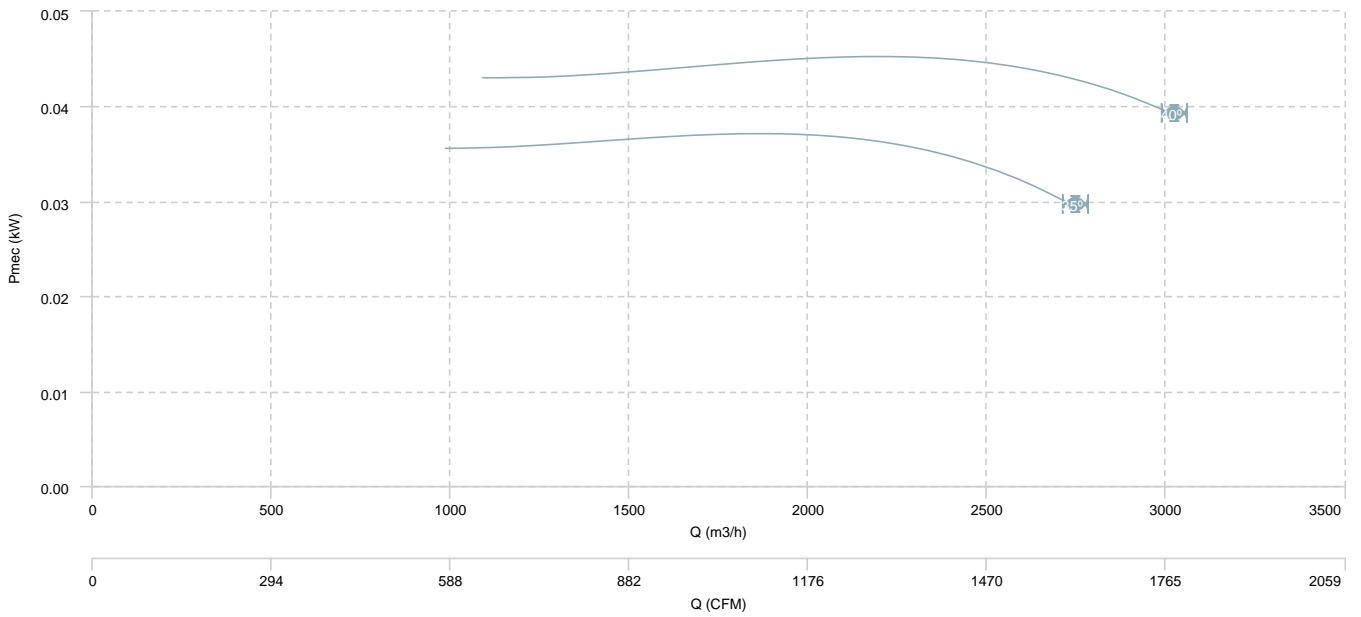

HC 40 T4/T8 (A0:6)

AIR FLOW - PRESSURE (4 poles)

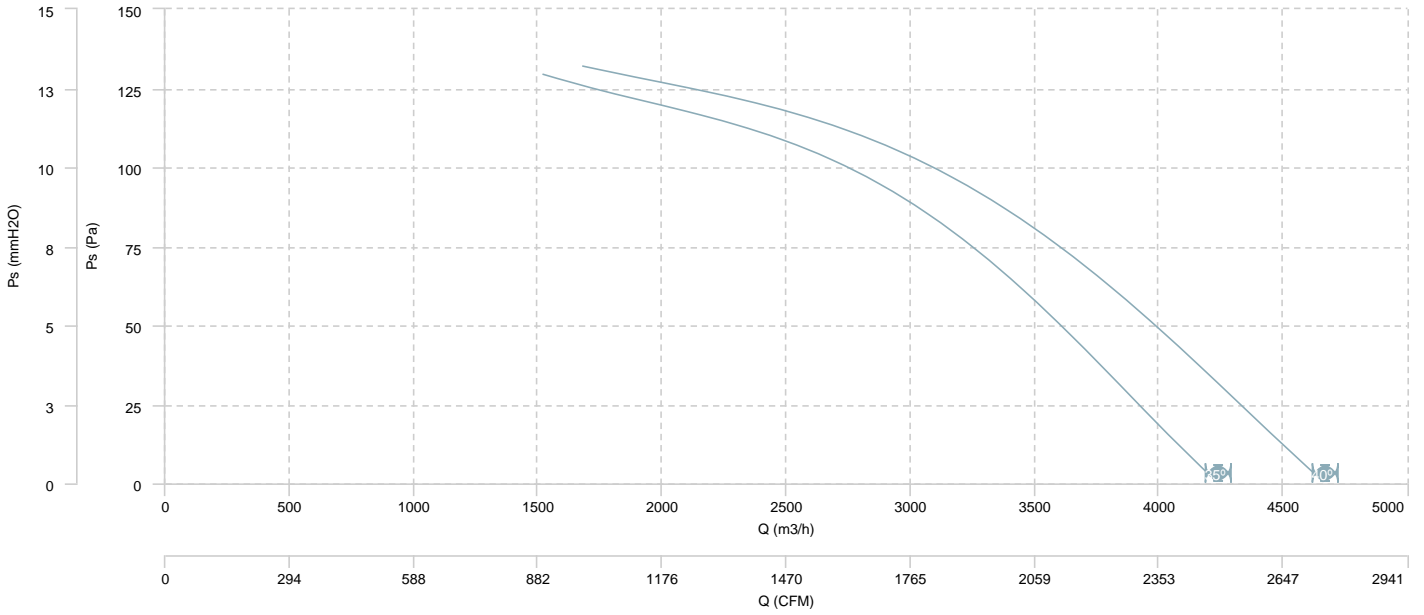

AIR FLOW - MECHANICAL POWER (4 poles)

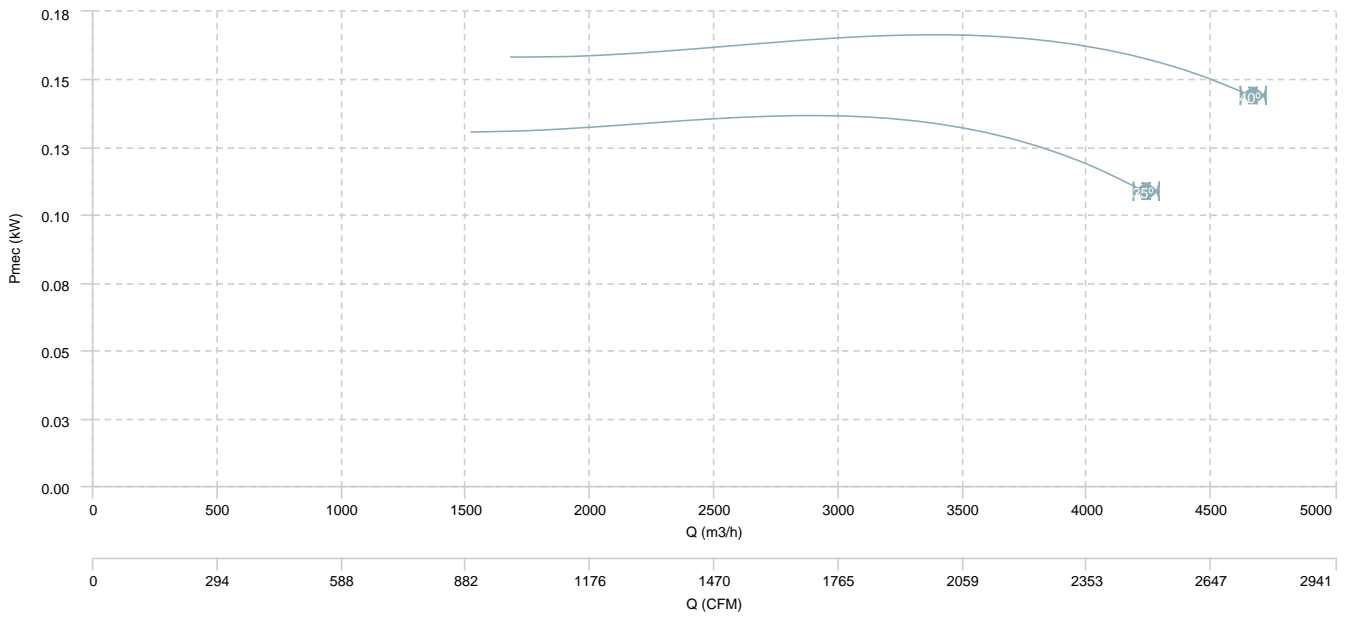

HC 40 T4/T8 (A0:6)

AIR FLOW - PRESSURE (8 poles)

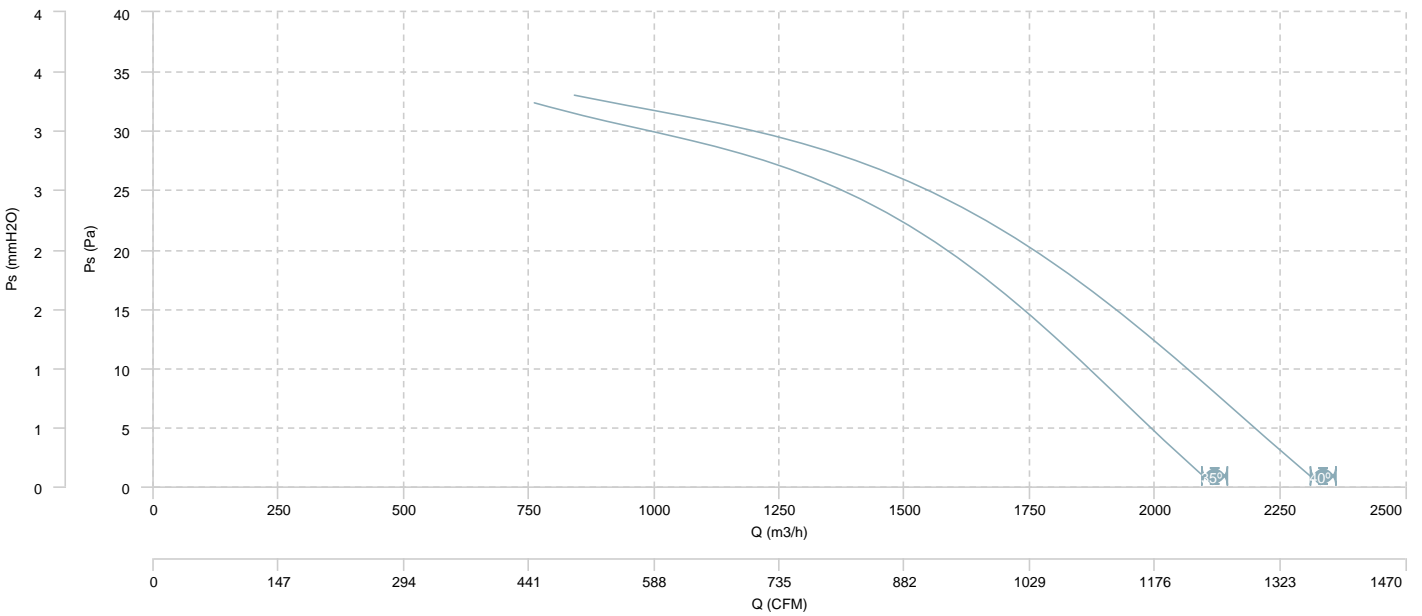

AIR FLOW - MECHANICAL POWER (8 poles)

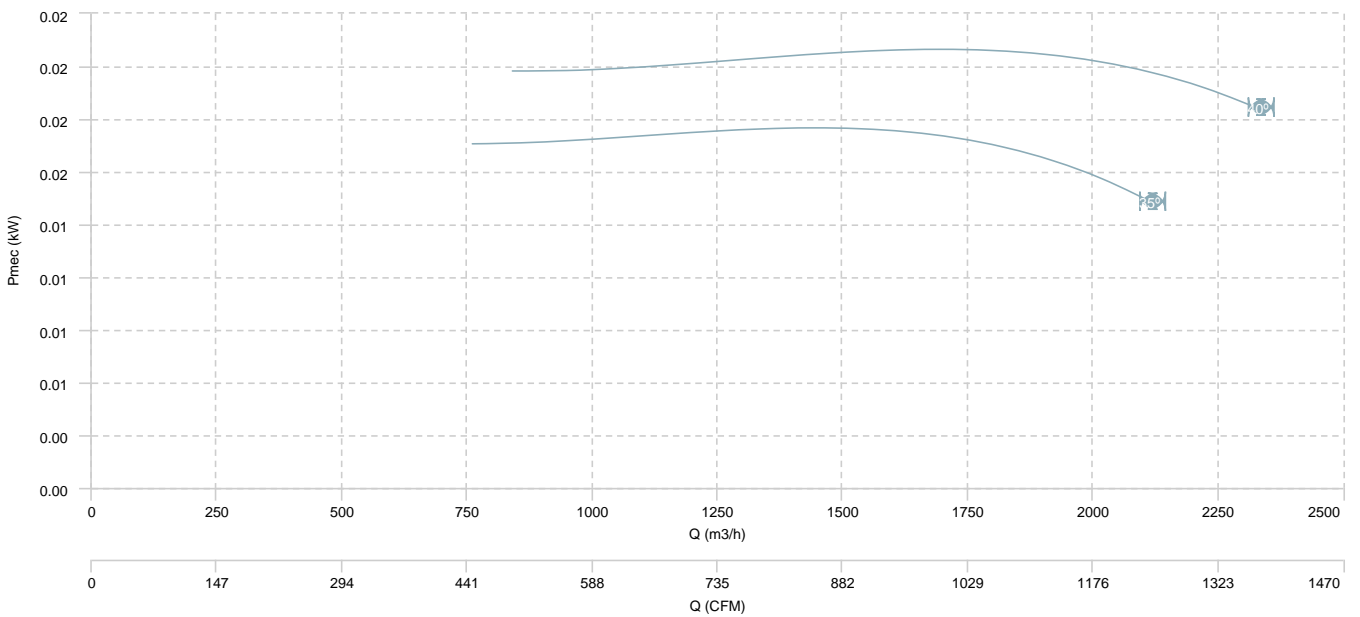

HC 45 T4 (A0:6)

AIR FLOW - PRESSURE

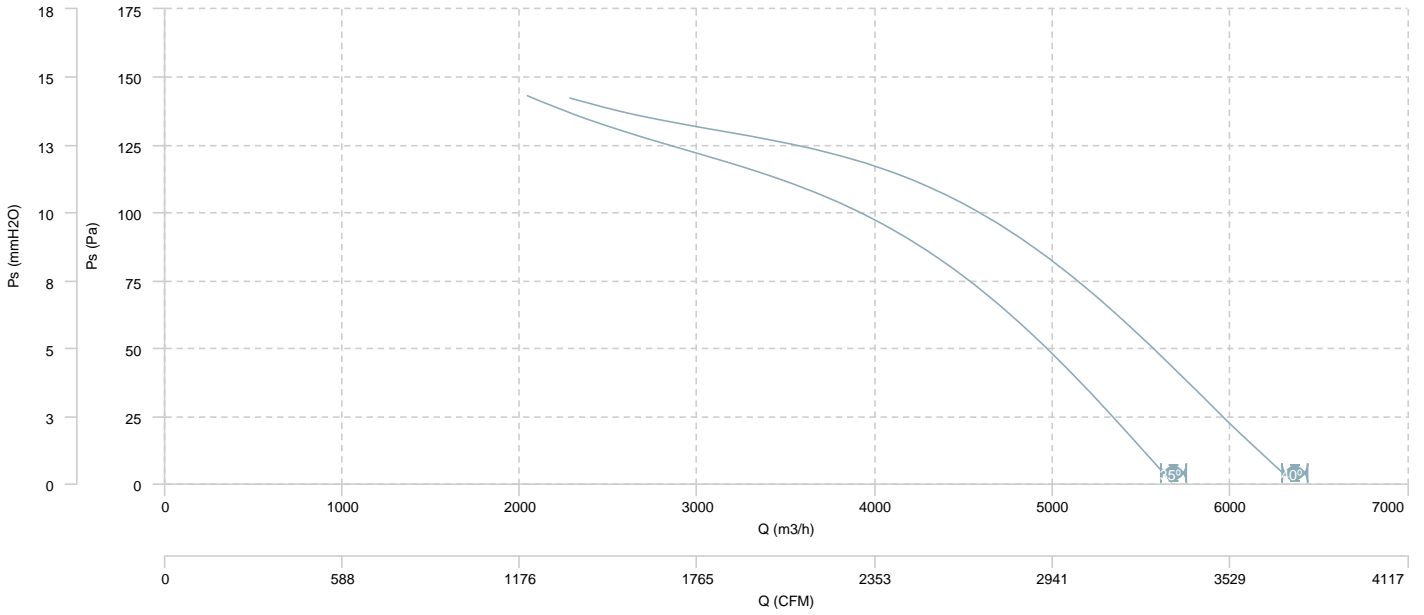

AIR FLOW - MECHANICAL POWER

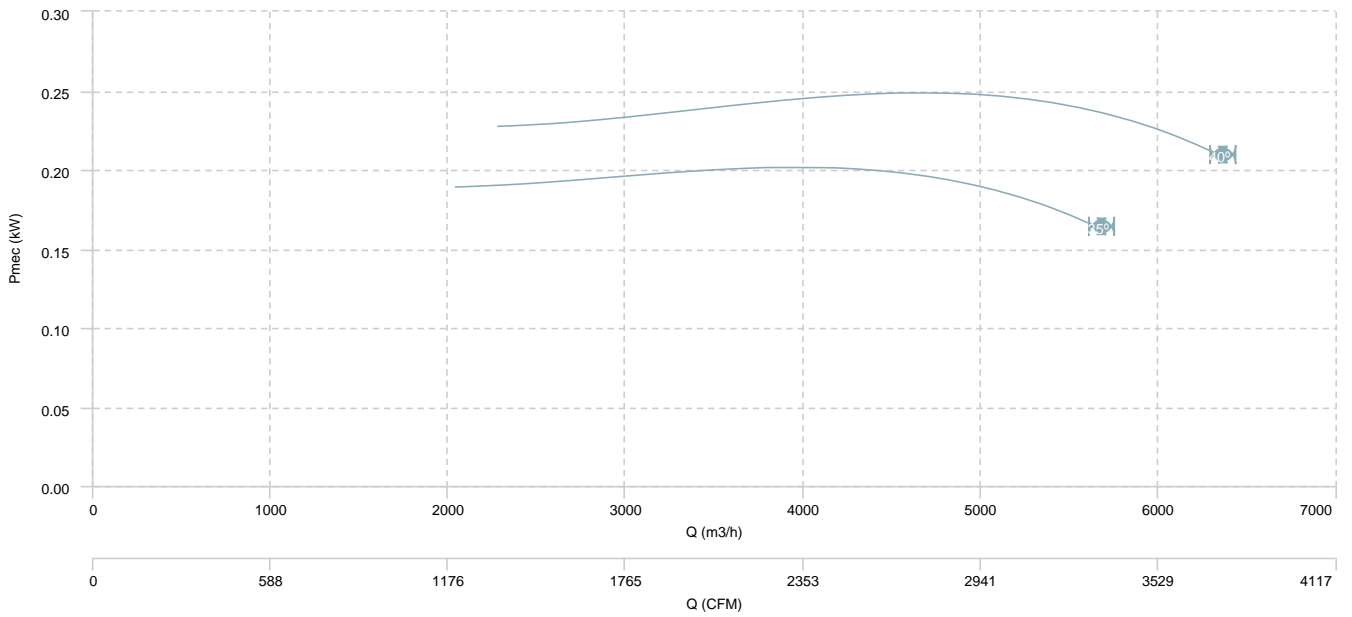

HC 45 T4 (A5:6)

AIR FLOW - PRESSURE

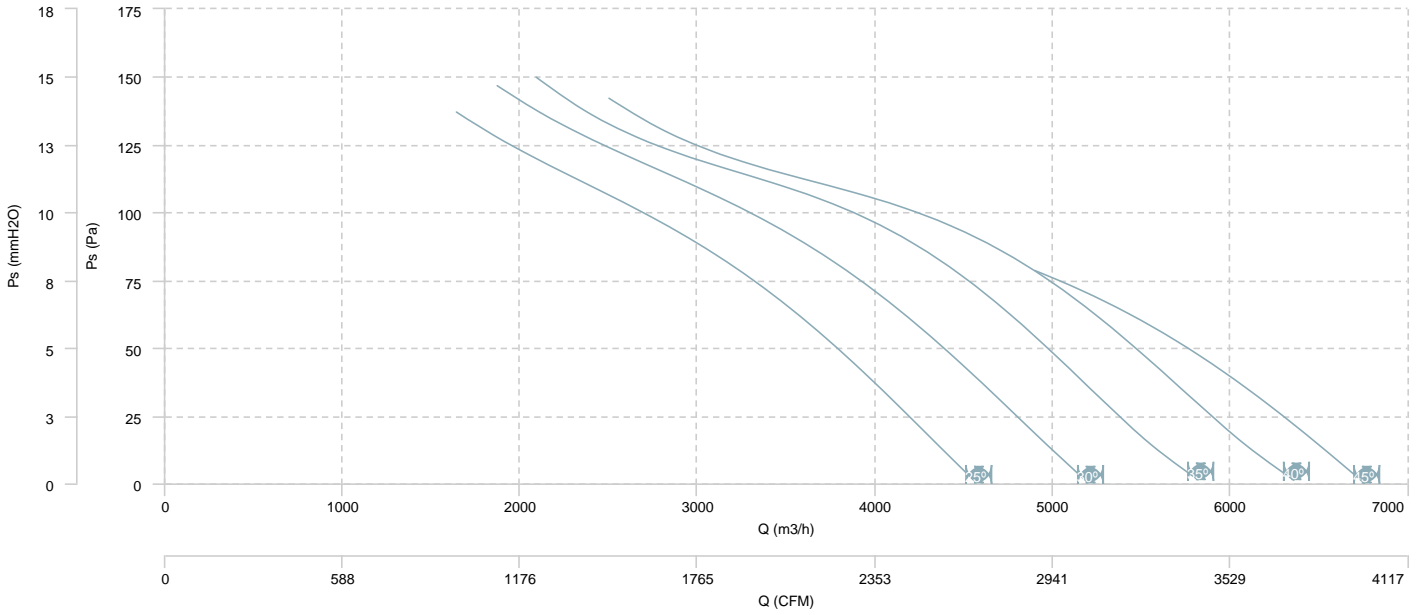

AIR FLOW - MECHANICAL POWER

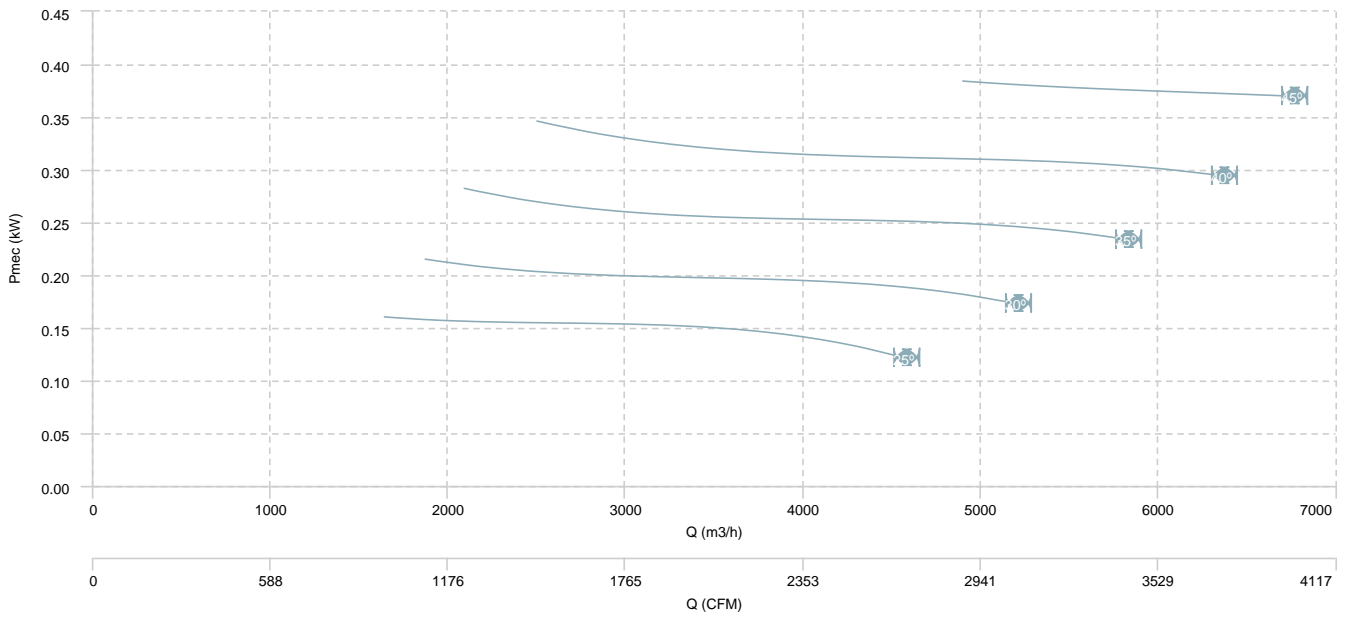

HC 45 T6 (A0:6)

AIR FLOW - PRESSURE

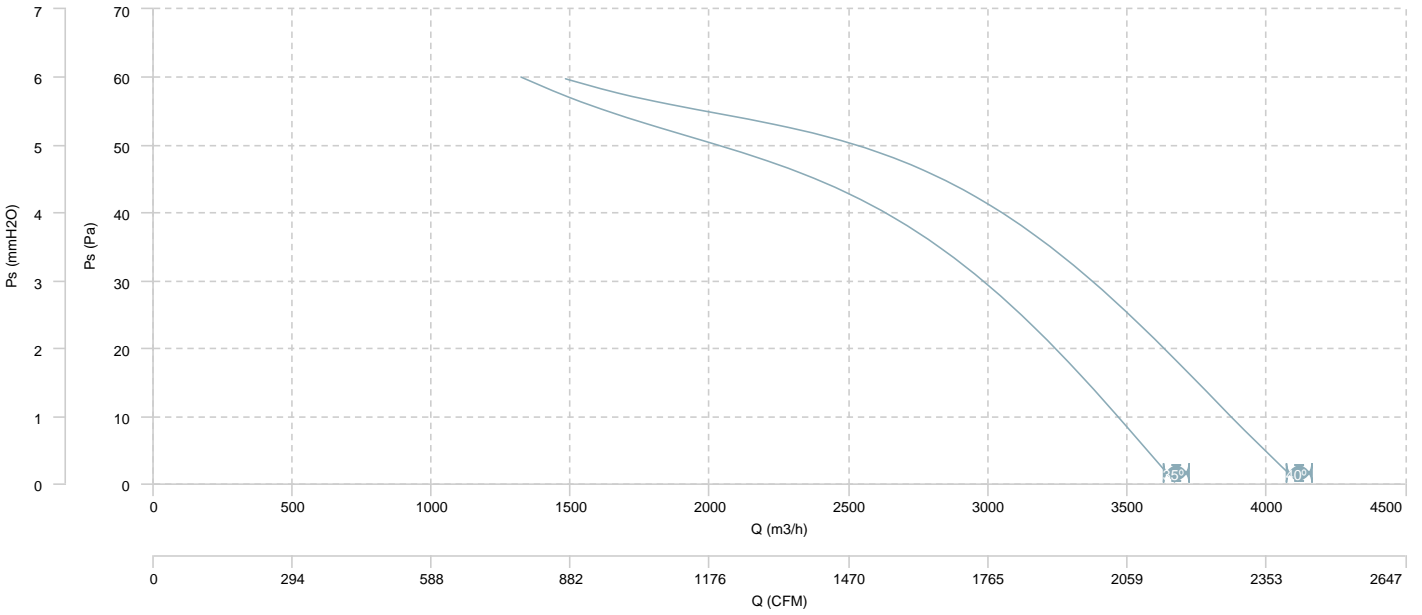

AIR FLOW - MECHANICAL POWER

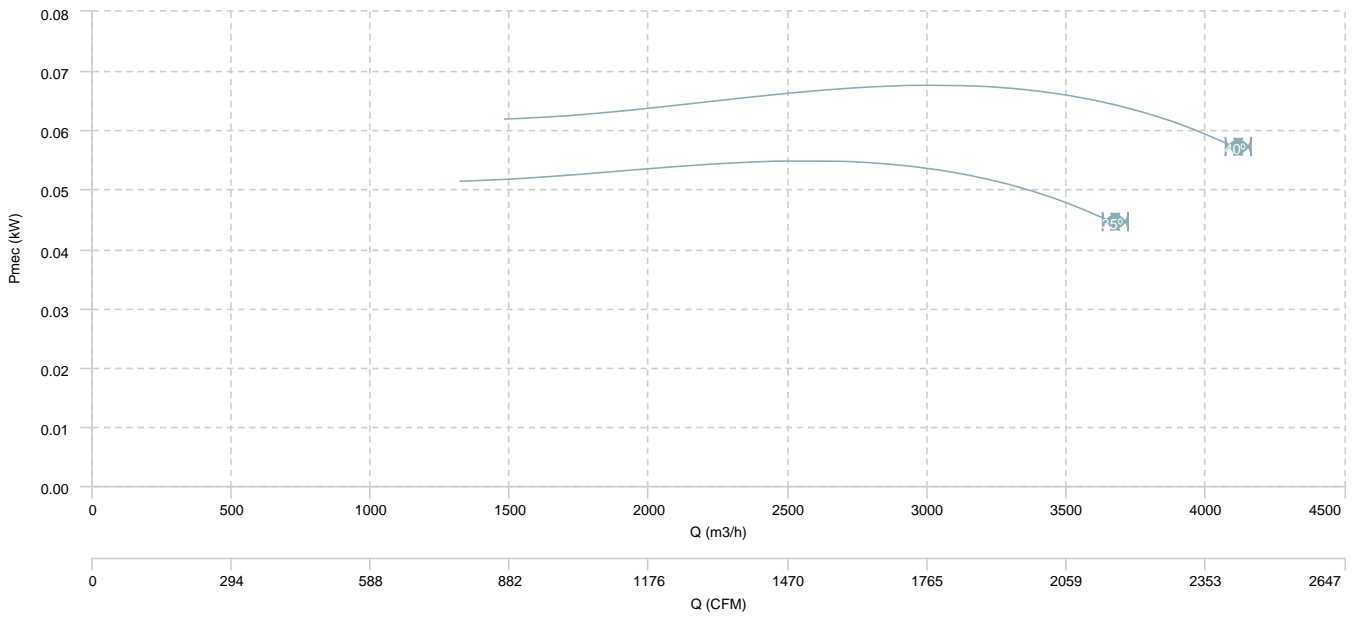

HC 45 T6 (A5:6)

AIR FLOW - PRESSURE

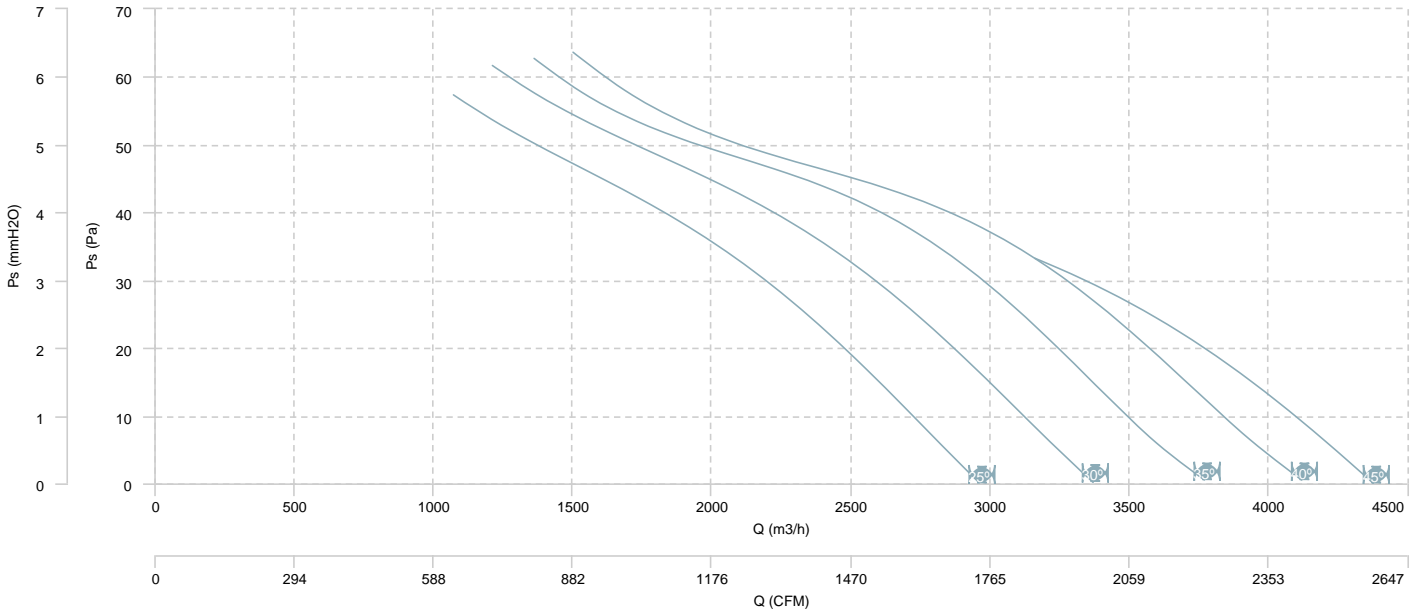

AIR FLOW - MECHANICAL POWER

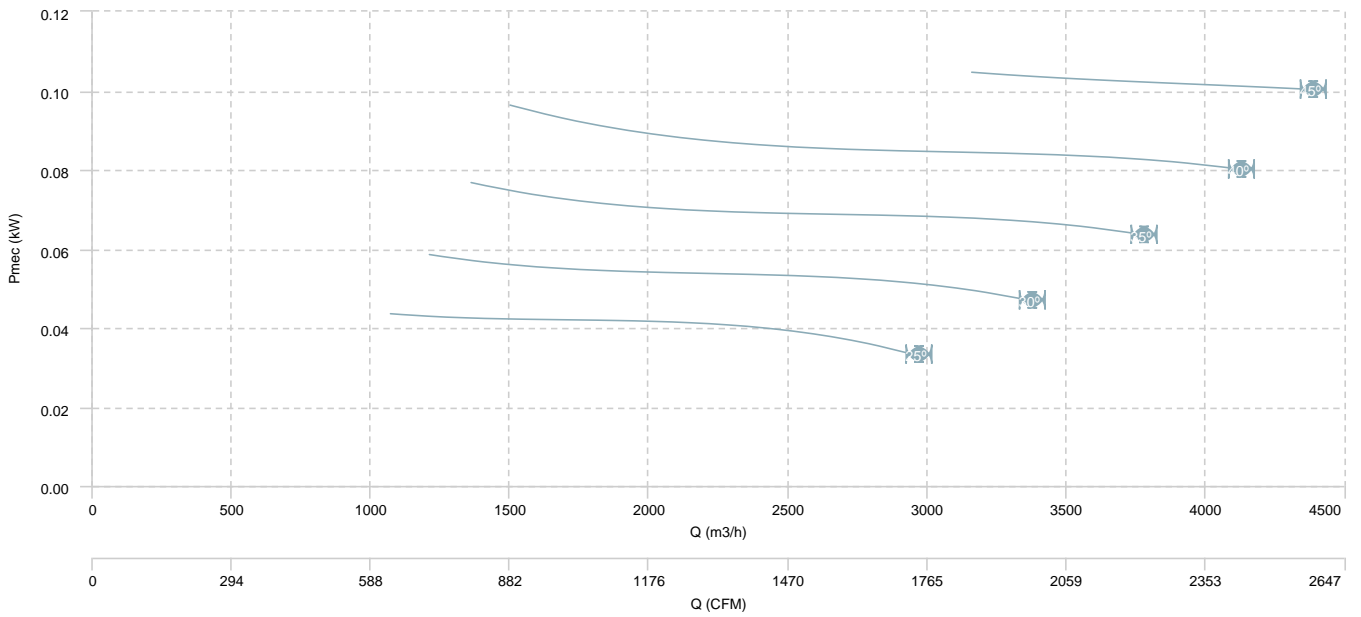

HC 45 T4/T8 (A0:6)

AIR FLOW - PRESSURE (4 poles)

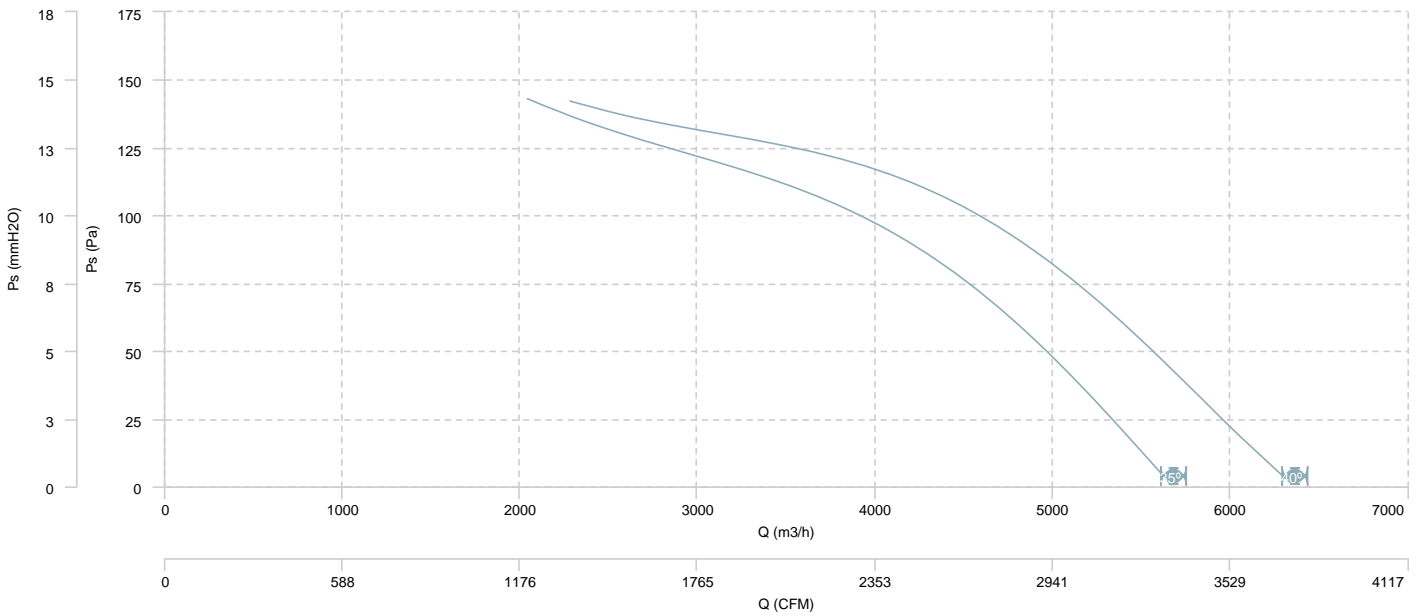

AIR FLOW - MECHANICAL POWER (4 poles)

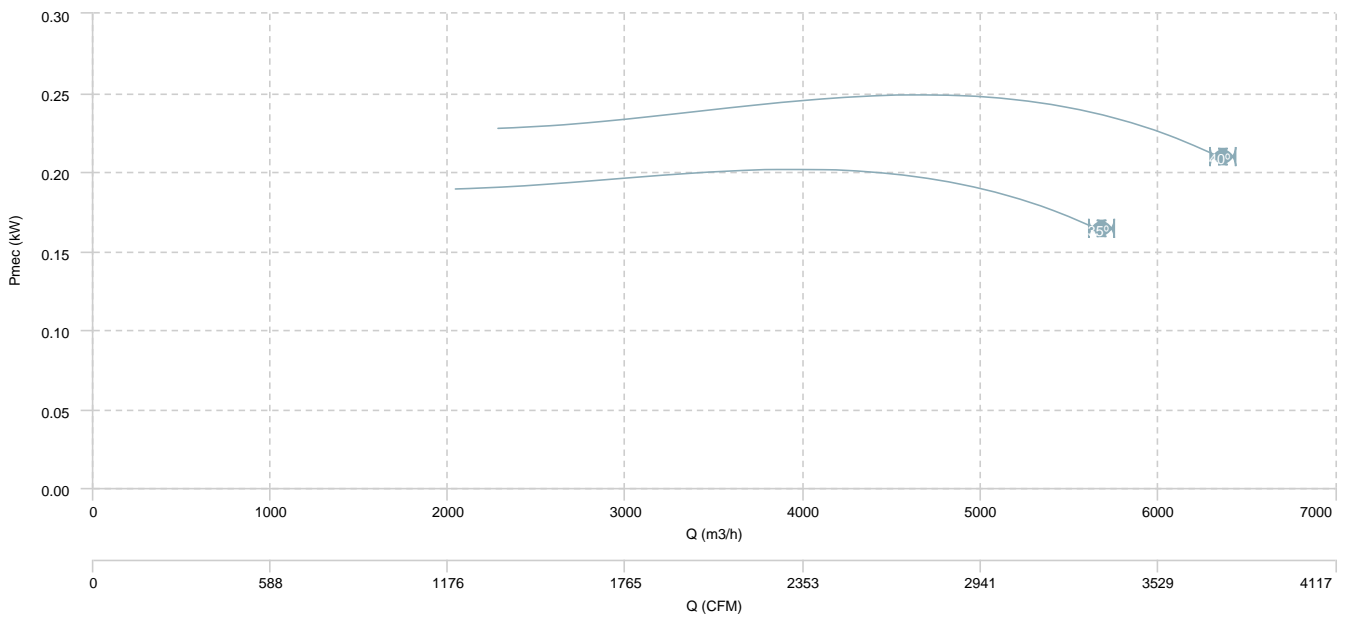

HC 45 T4/T8 (A0:6)

AIR FLOW - PRESSURE (8 poles)

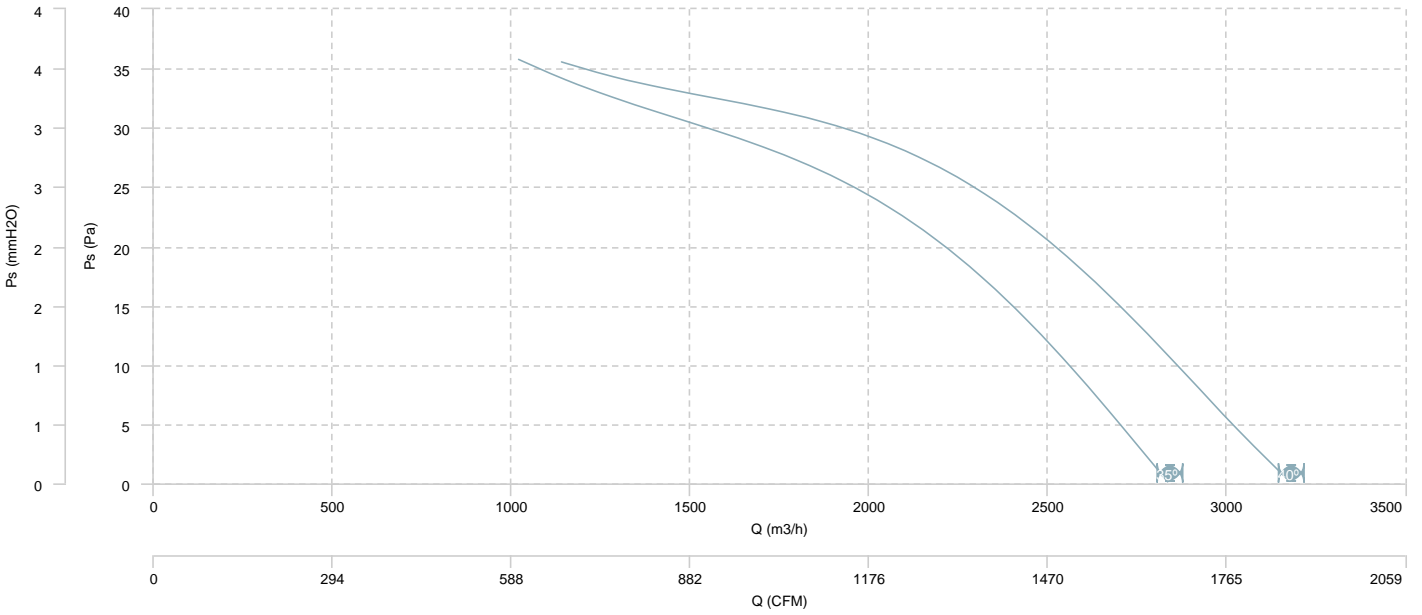

AIR FLOW - MECHANICAL POWER (8 poles)

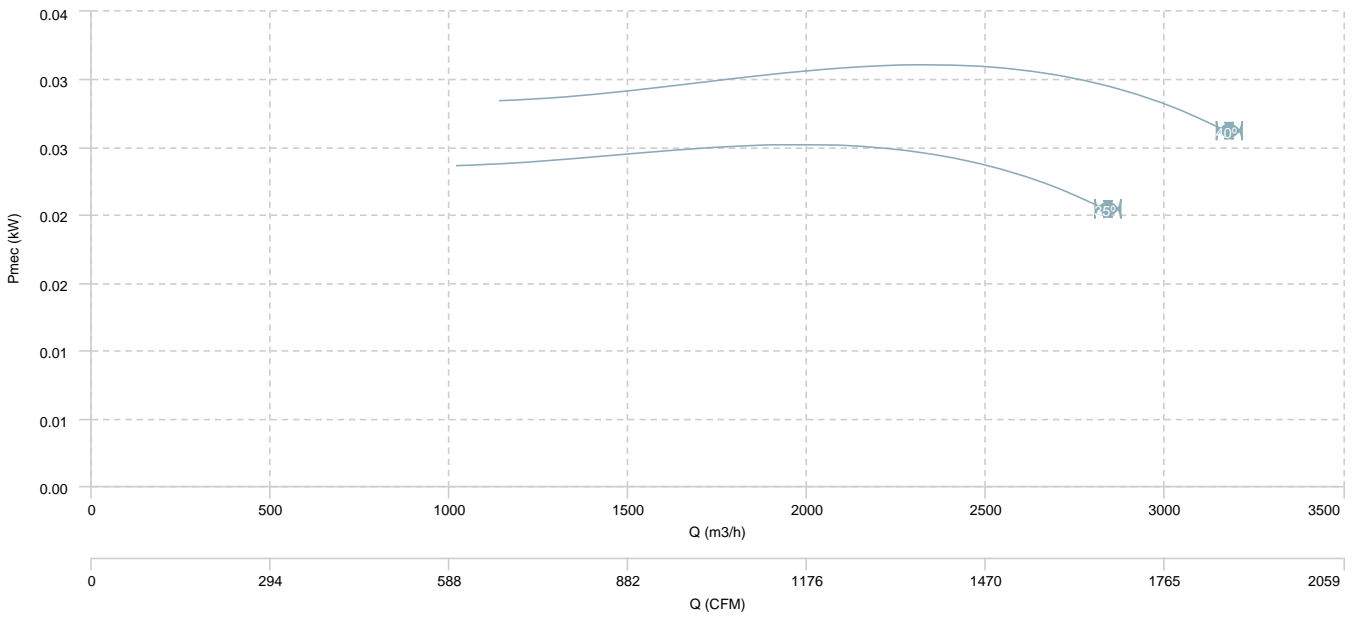

HC 45 T4/T8 (A5:6)

AIR FLOW - PRESSURE (4 poles)

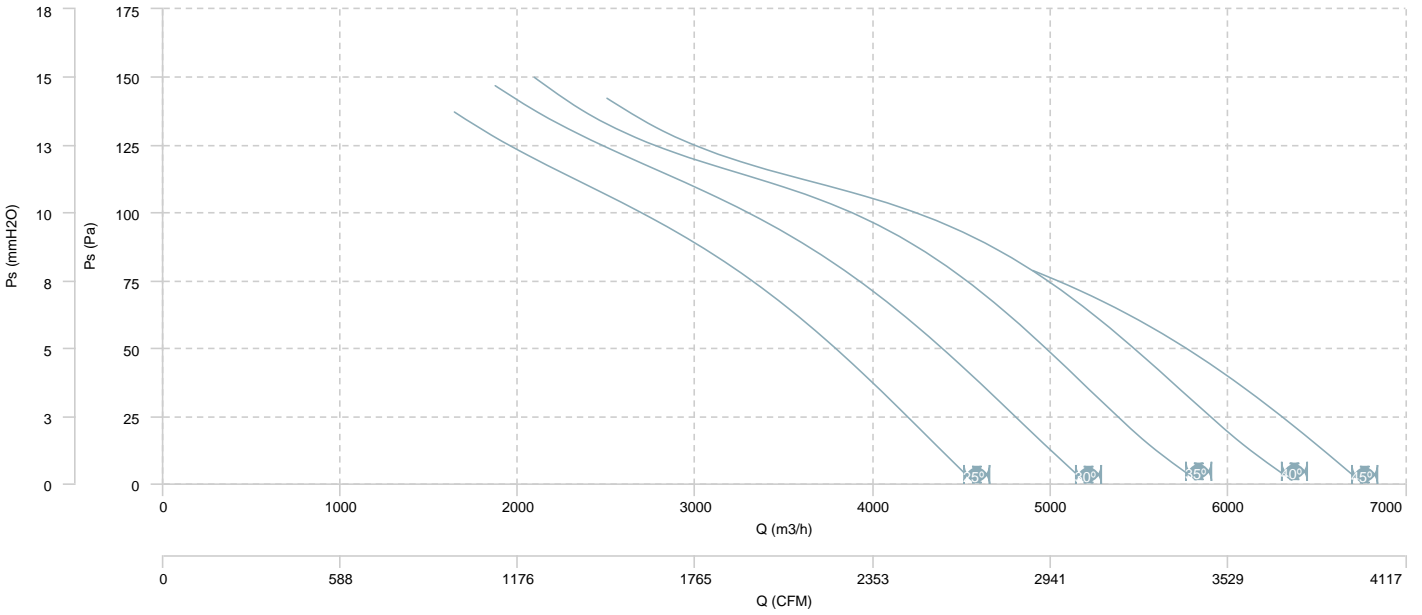

AIR FLOW - MECHANICAL POWER (4 poles)

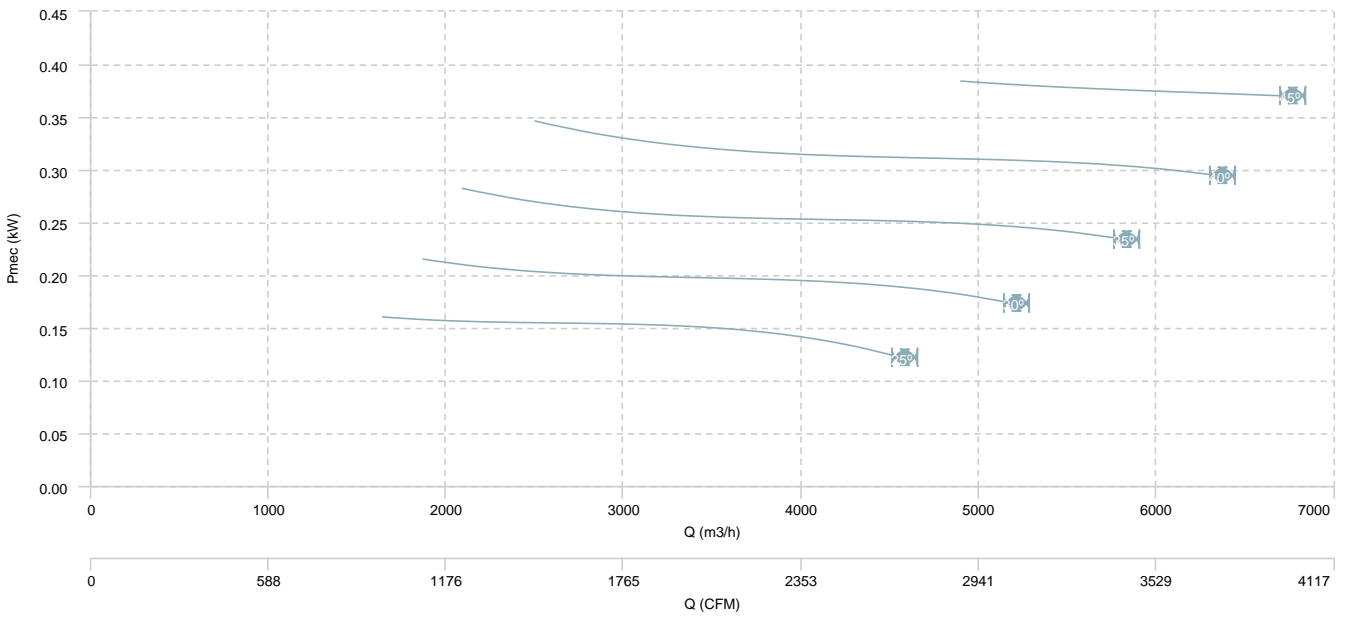

HC 45 T4/T8 (A5:6)

AIR FLOW - PRESSURE (8 poles)

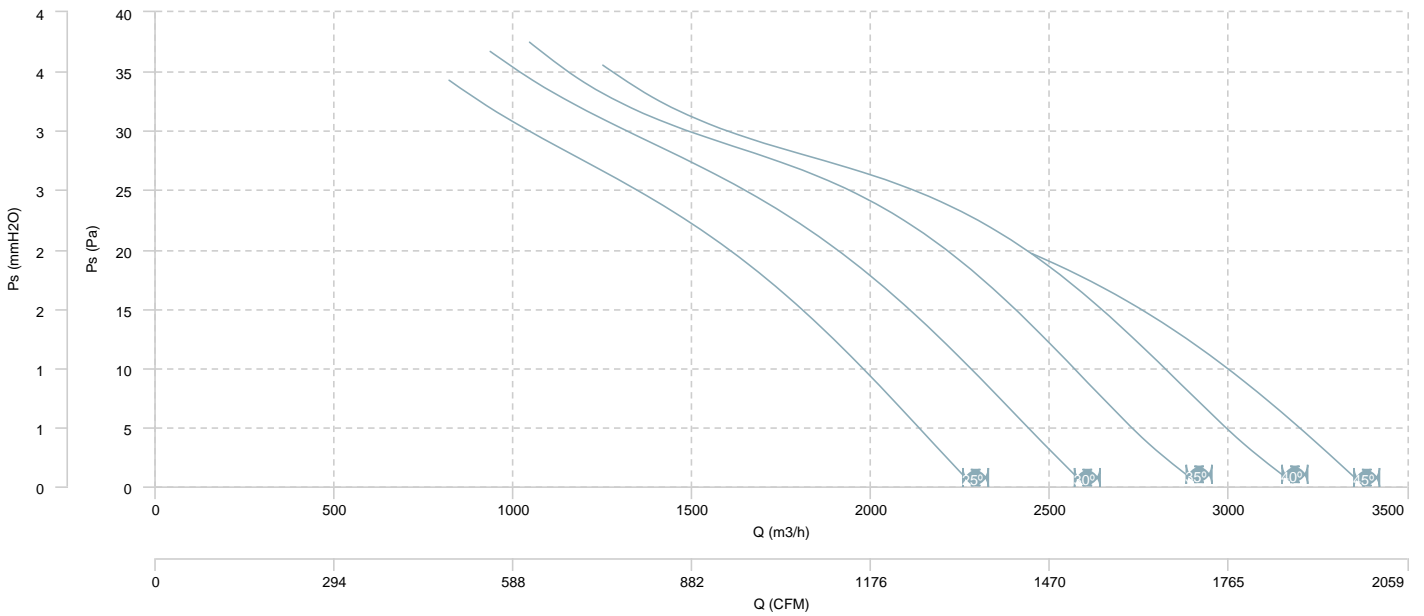

AIR FLOW - MECHANICAL POWER (8 poles)

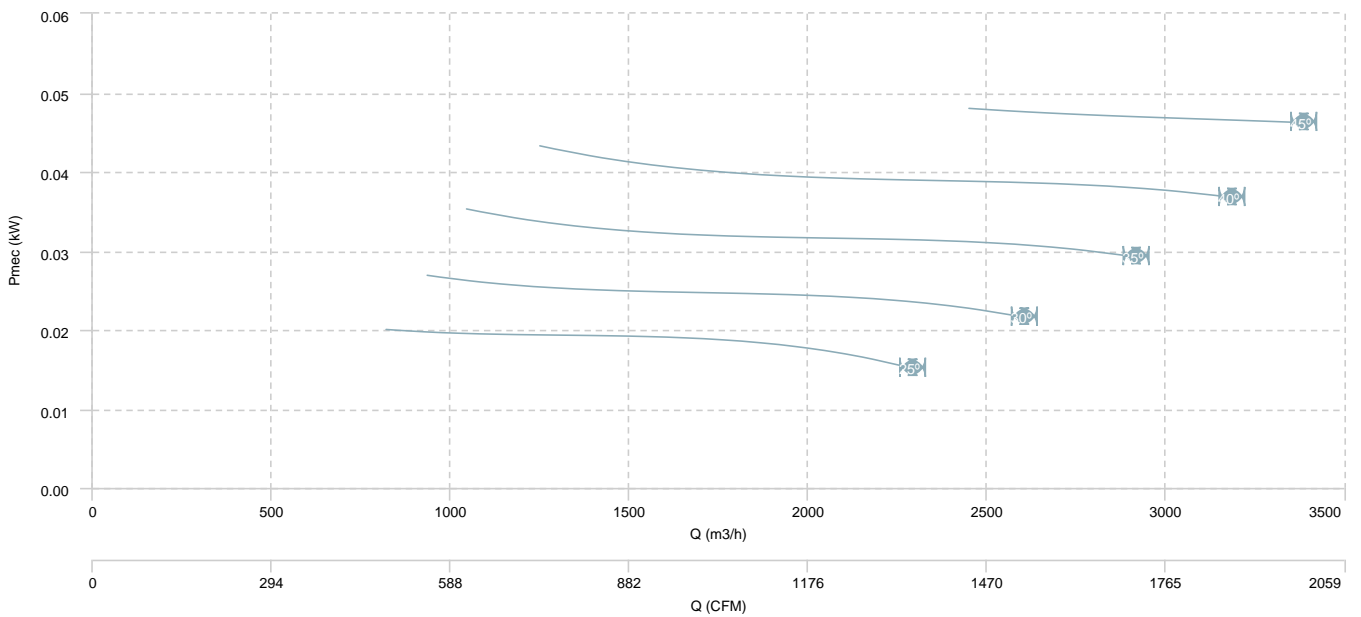

HC 50 T4 (A0:6)

AIR FLOW - PRESSURE

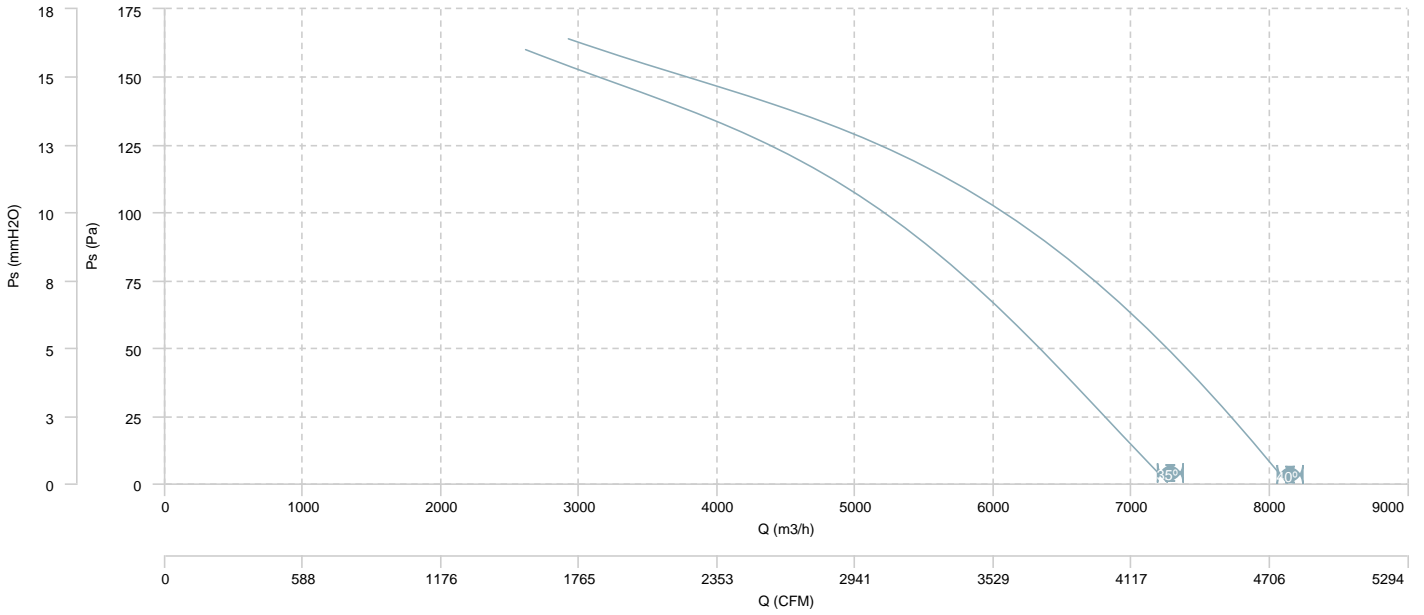

AIR FLOW - MECHANICAL POWER

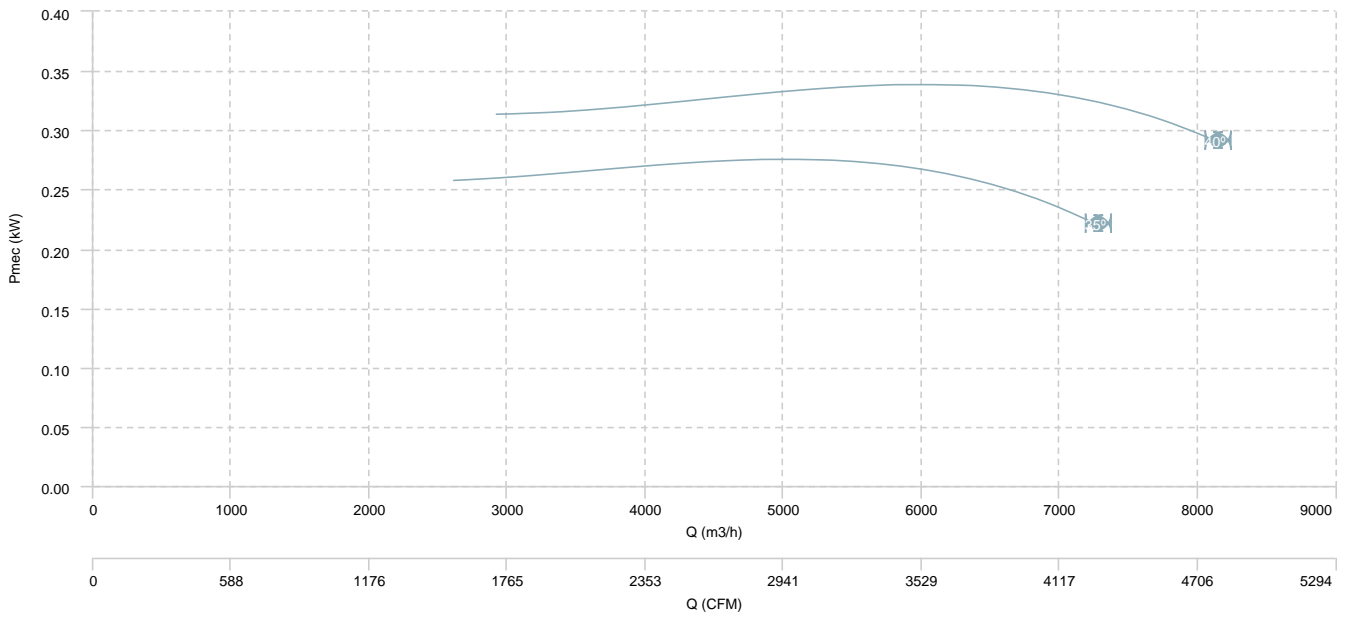

HC 50 T4 (A5:6)

AIR FLOW - PRESSURE

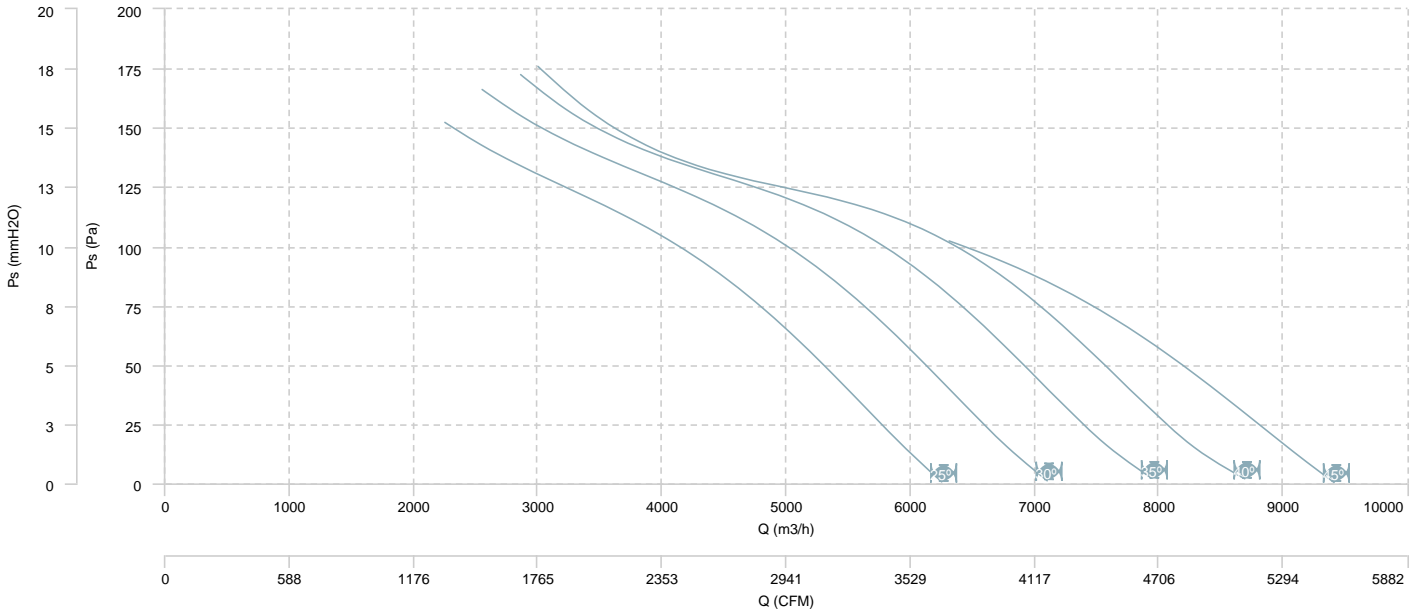

AIR FLOW - MECHANICAL POWER

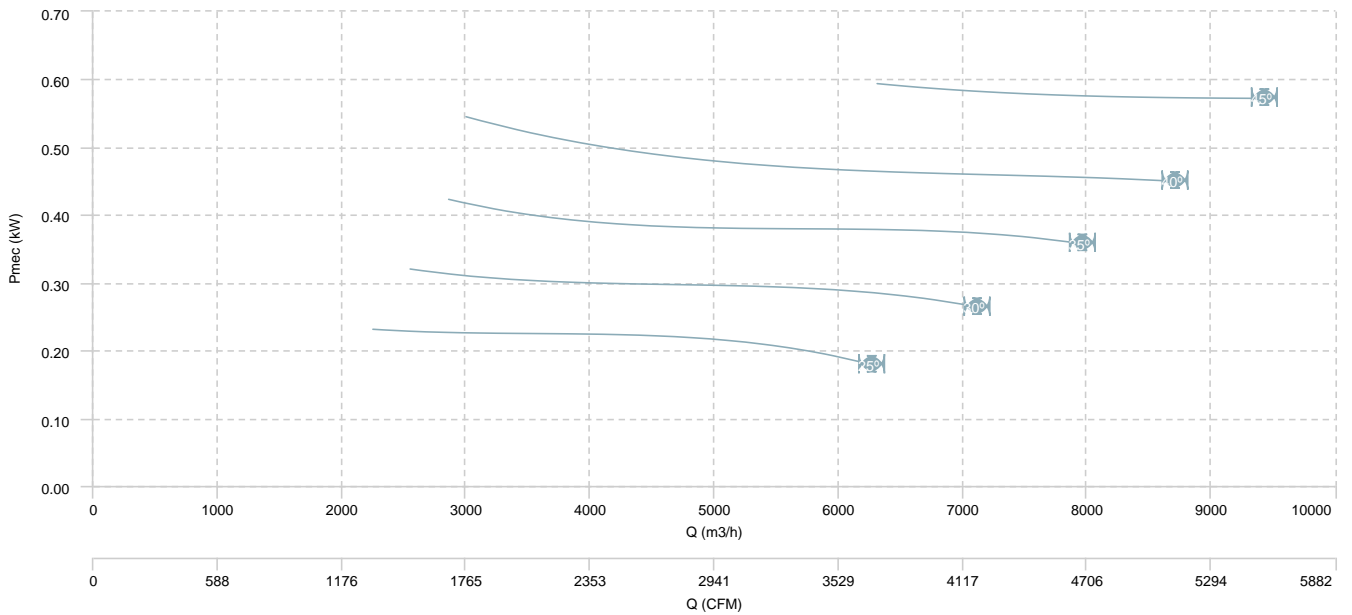

HC 50 T6 (A0:6)

AIR FLOW - PRESSURE

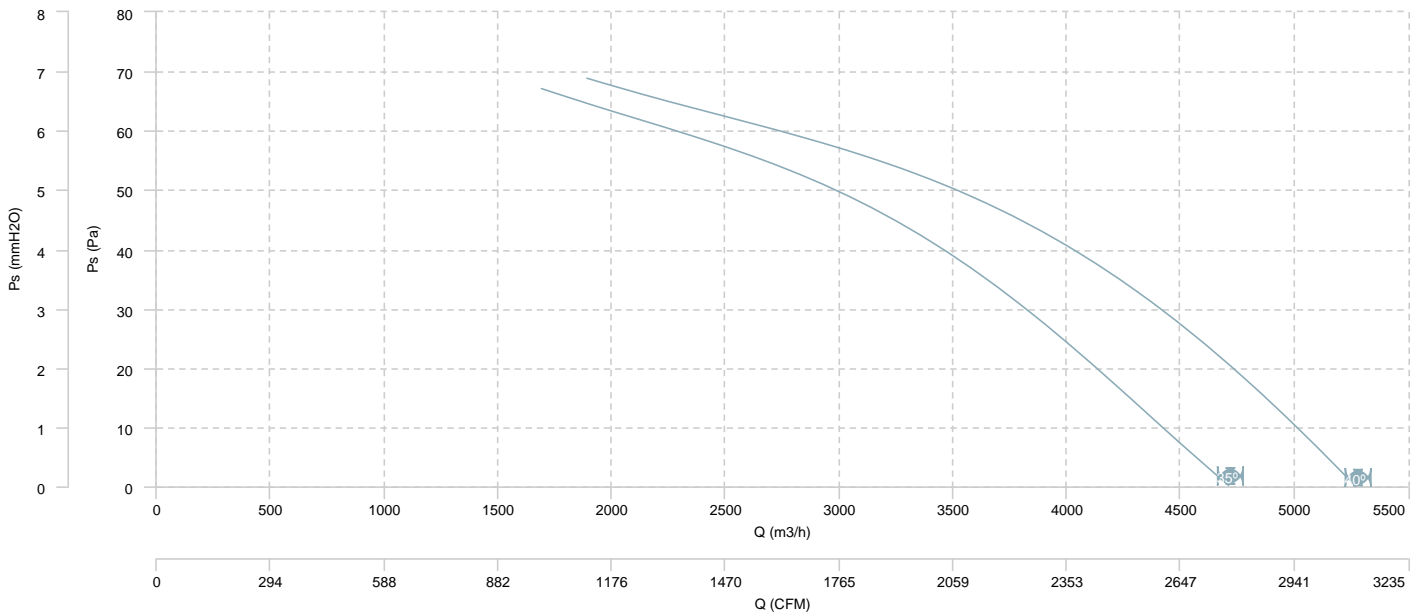

AIR FLOW - MECHANICAL POWER

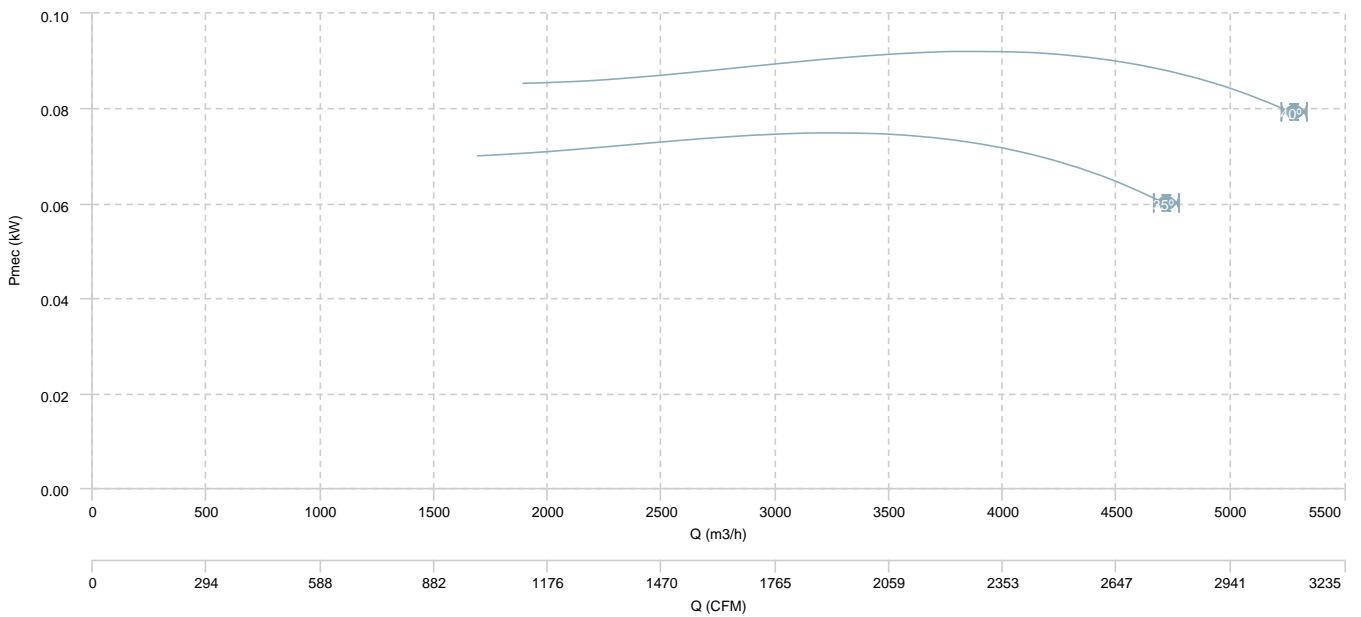

HC 50 T6 (A5:6)

AIR FLOW - PRESSURE

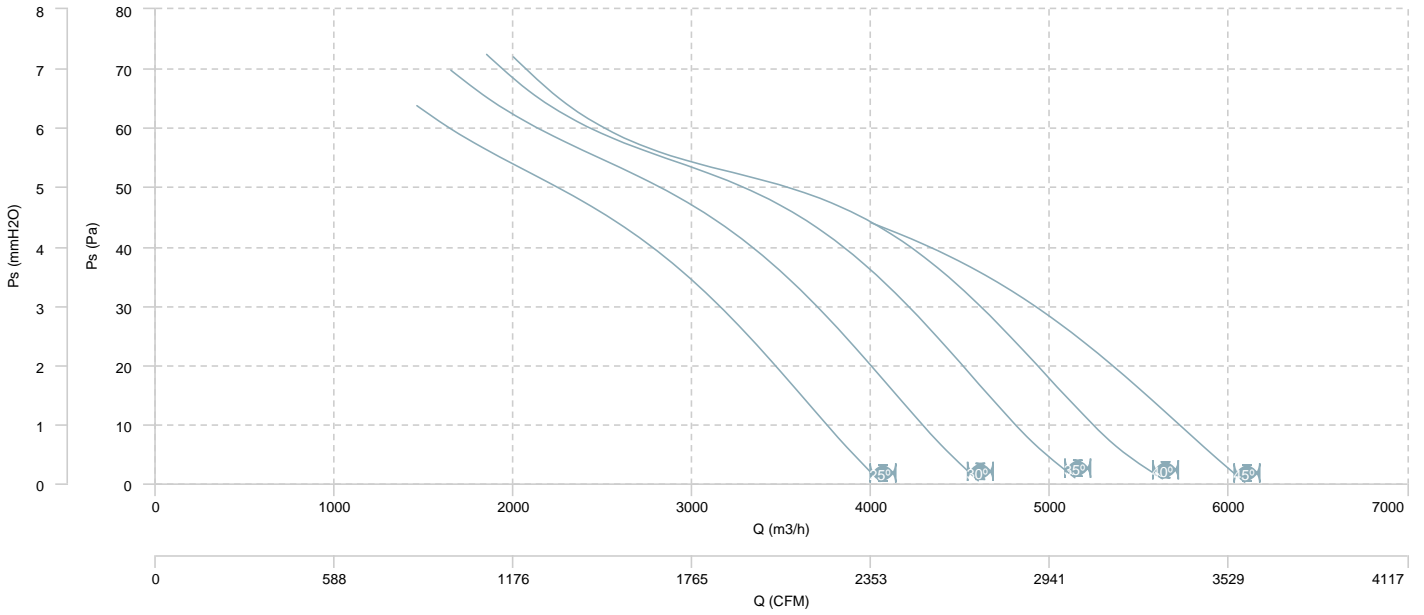

AIR FLOW - MECHANICAL POWER

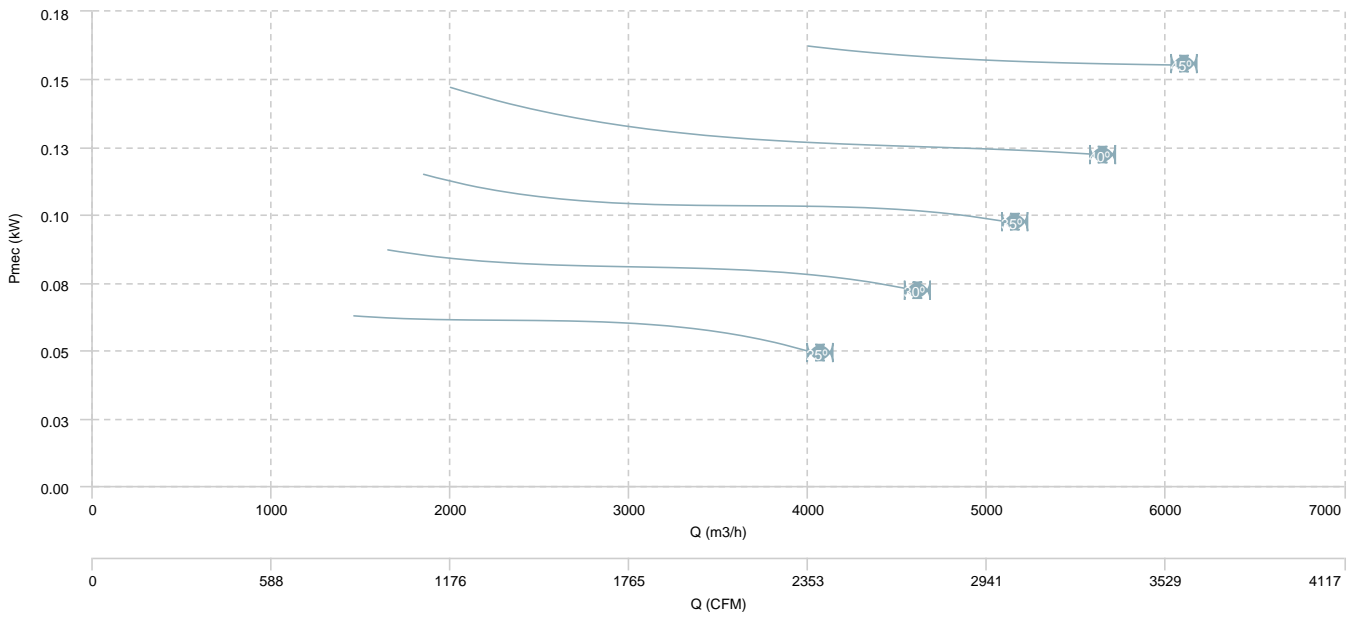

HC 50 T4/T8 (A0:6)

AIR FLOW - PRESSURE (4 poles)

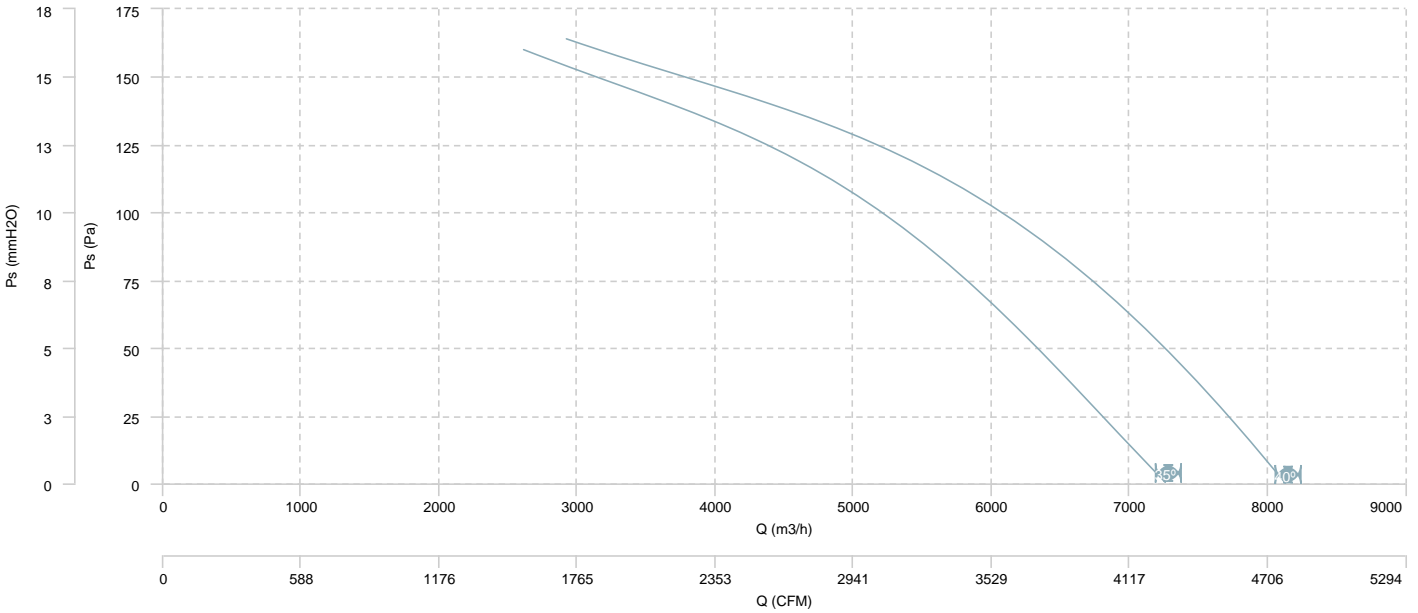

AIR FLOW - MECHANICAL POWER (4 poles)

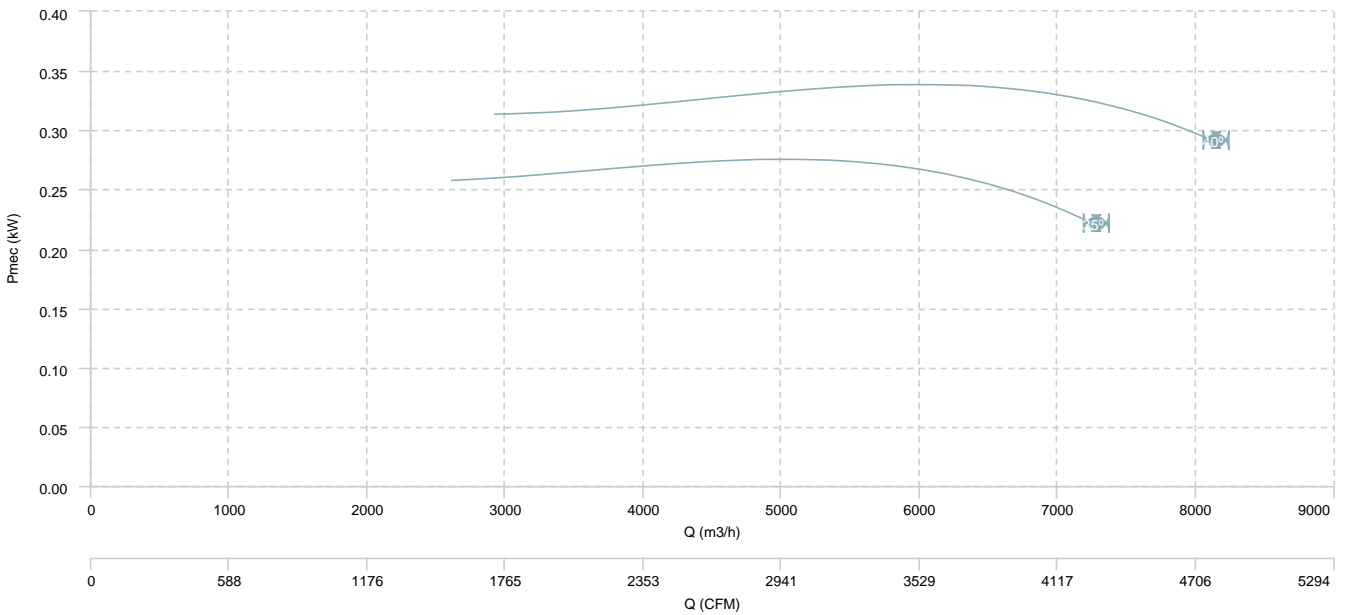

HC 50 T4/T8 (A0:6)

AIR FLOW - PRESSURE (8 poles)

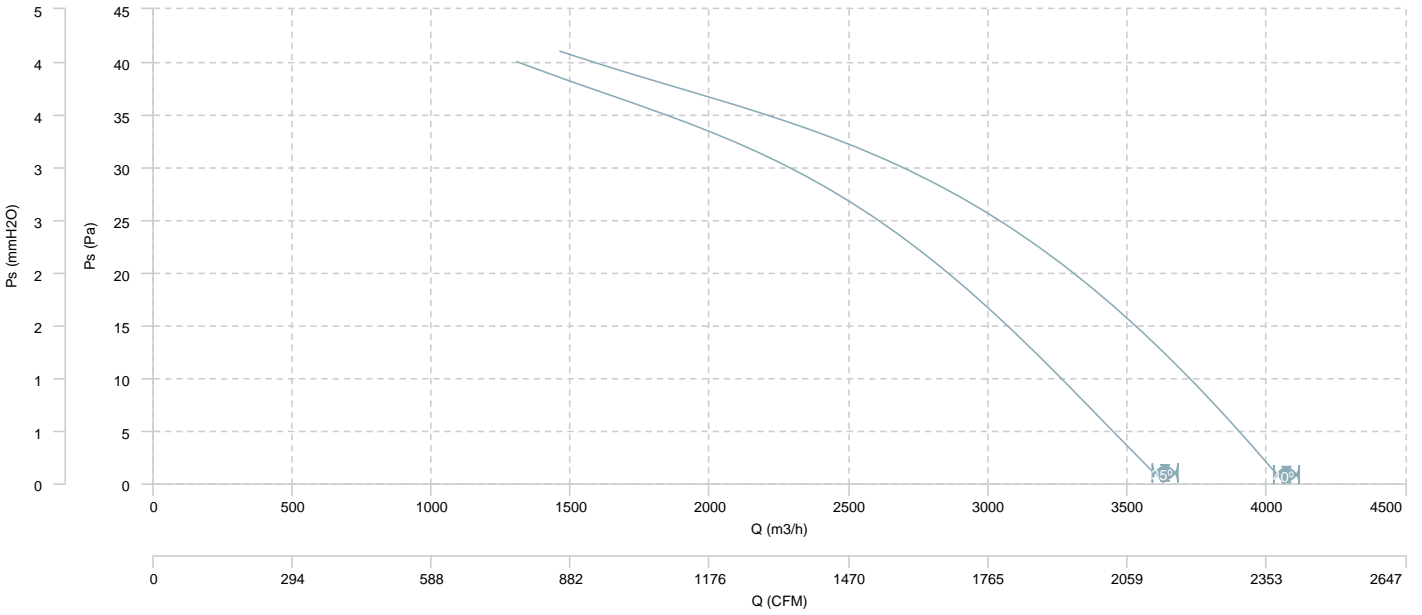

AIR FLOW - MECHANICAL POWER (8 poles)

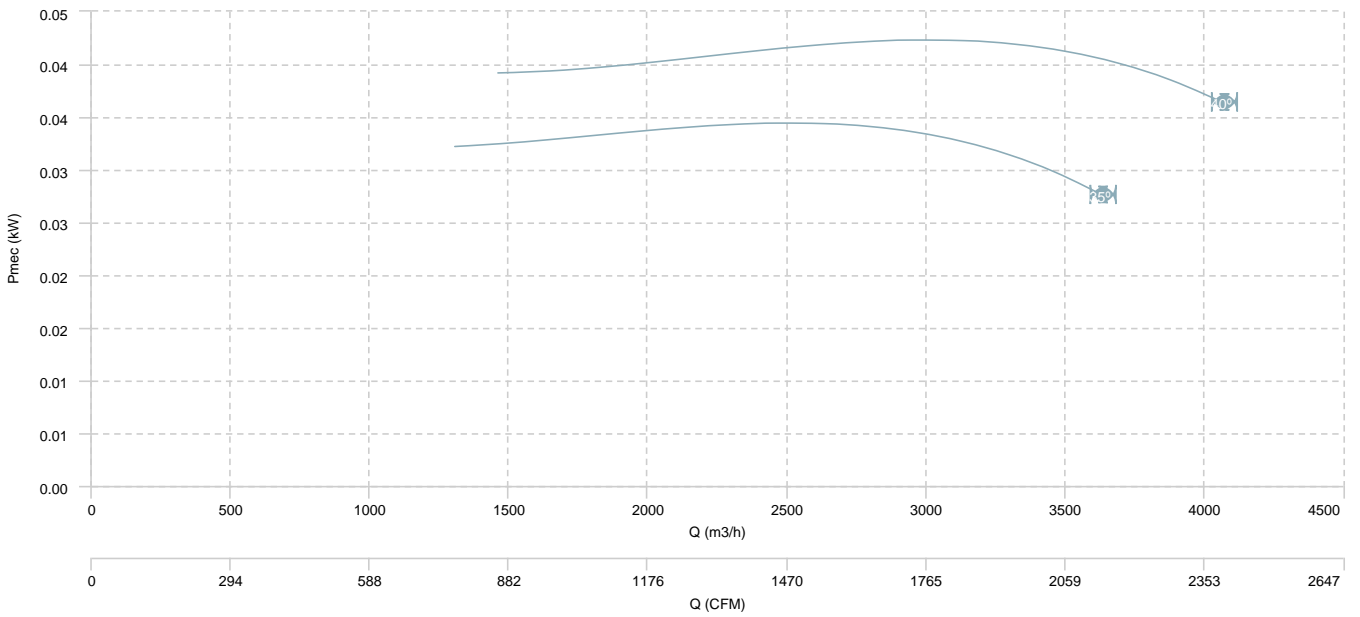

HC 50 T4/T8 (A5:6)

AIR FLOW - PRESSURE (4 poles)

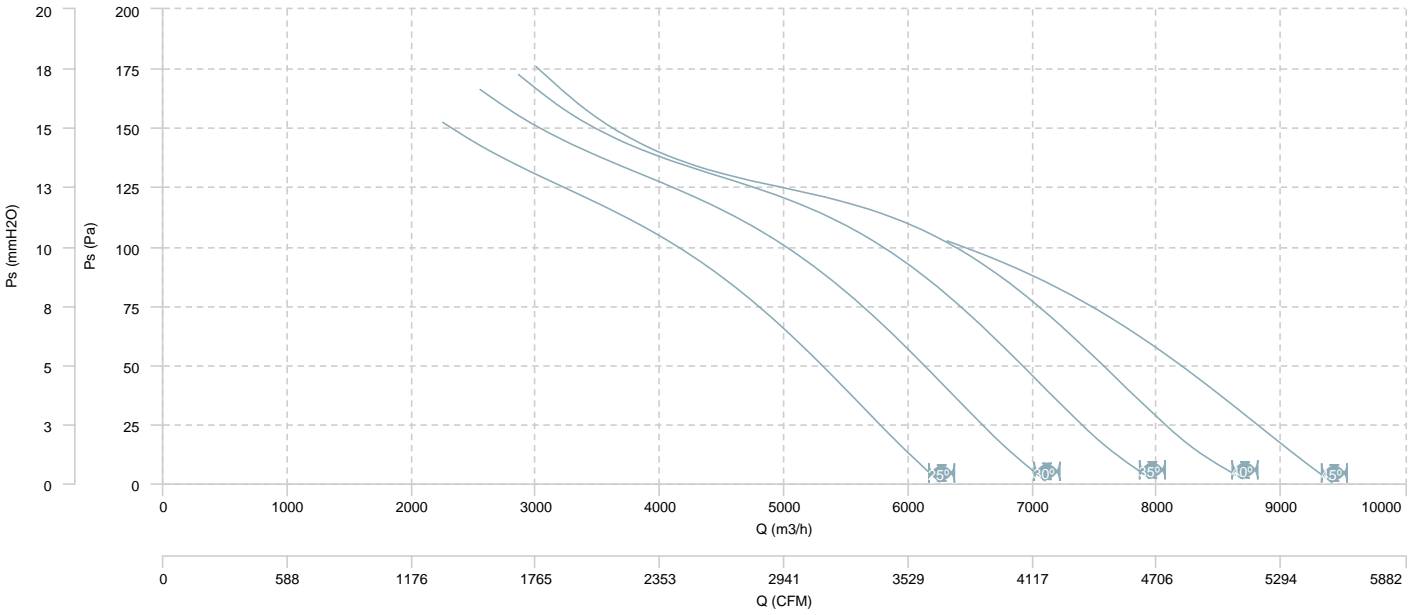

AIR FLOW - MECHANICAL POWER (4 poles)

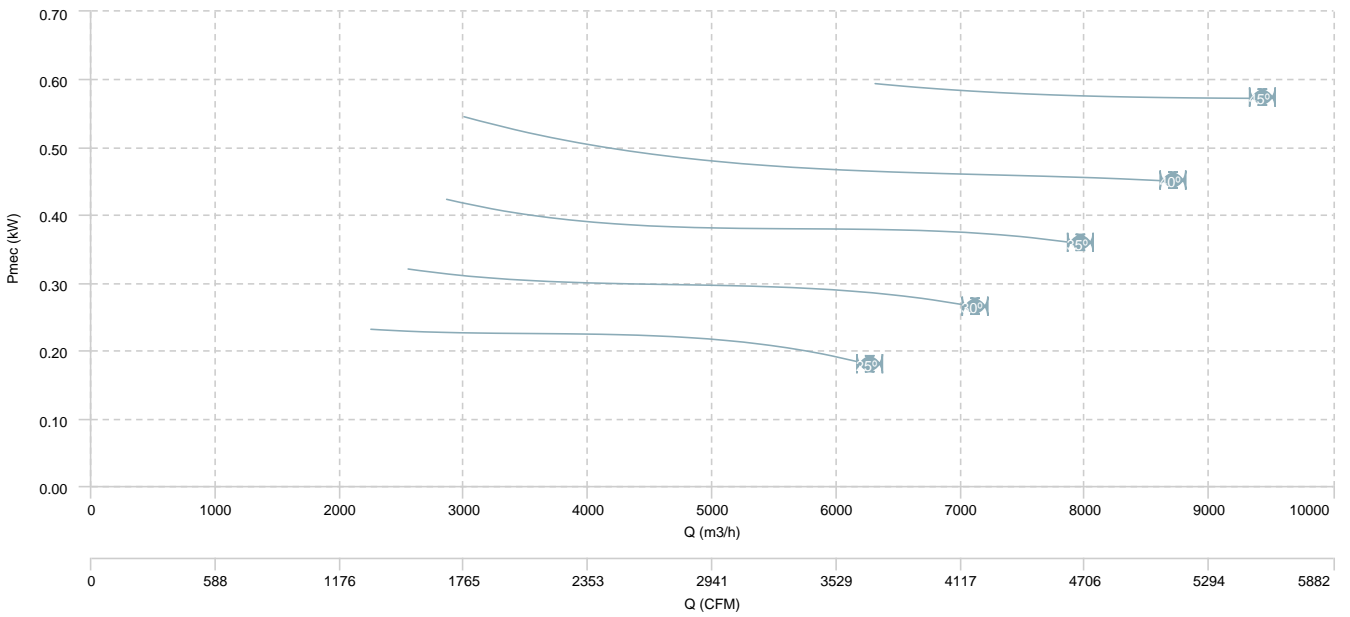

HC 50 T4/T8 (A5:6)

AIR FLOW - PRESSURE (8 poles)

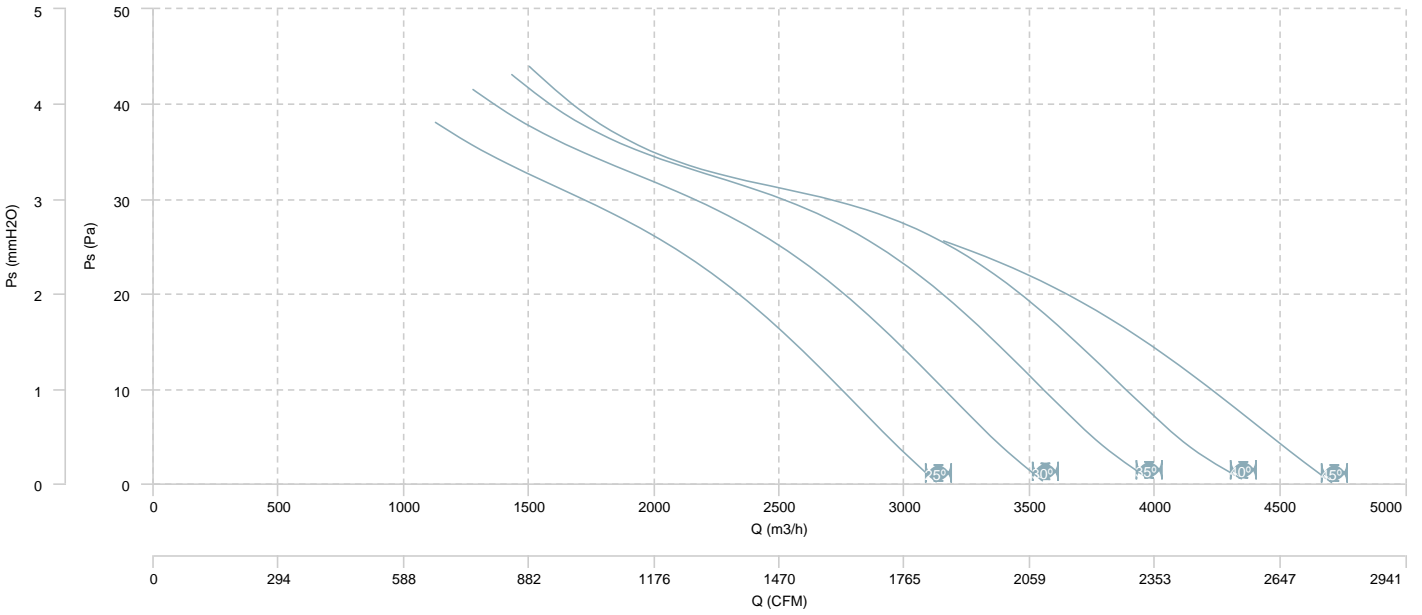

AIR FLOW - MECHANICAL POWER (8 poles)

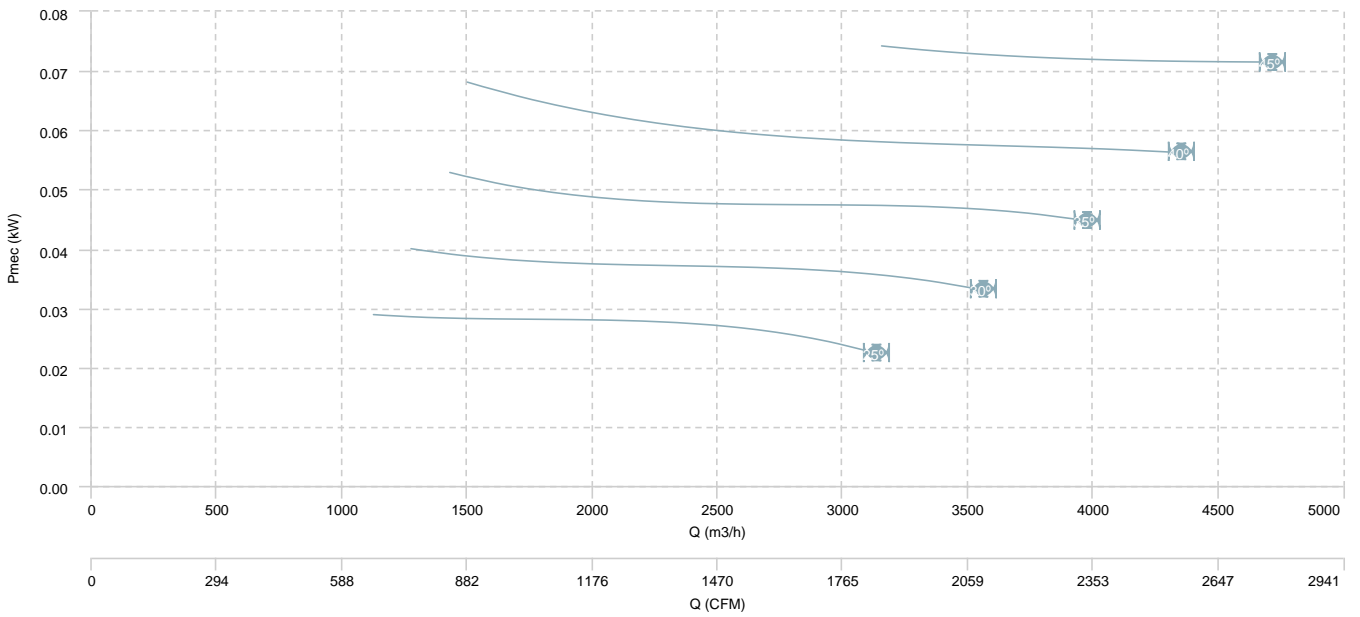

HC 56 T4 (A5:6)

AIR FLOW - PRESSURE

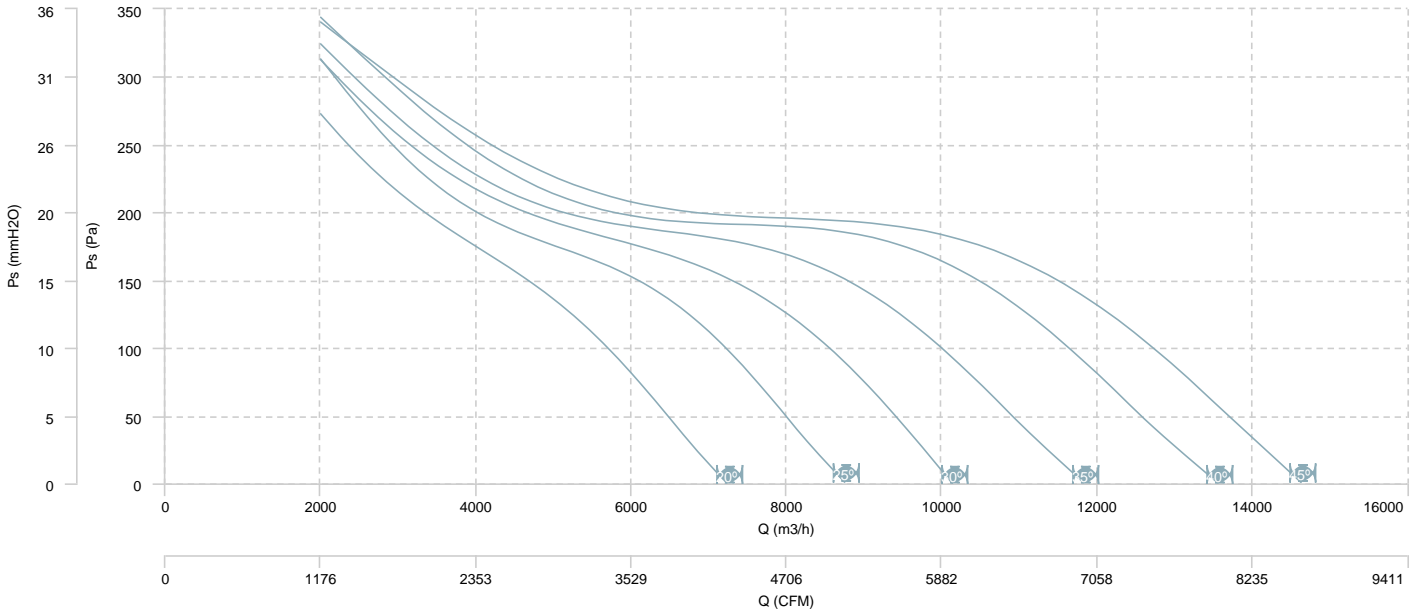

AIR FLOW - MECHANICAL POWER

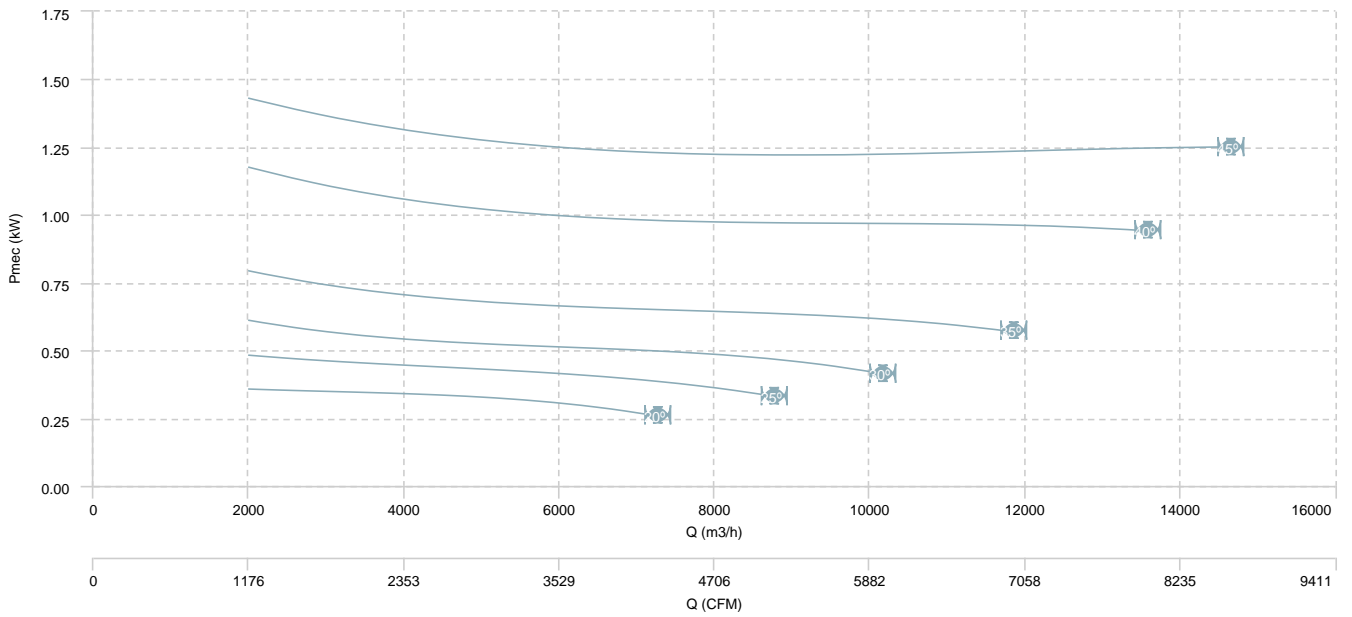

HC 56 T4 (A2:9)

AIR FLOW - PRESSURE

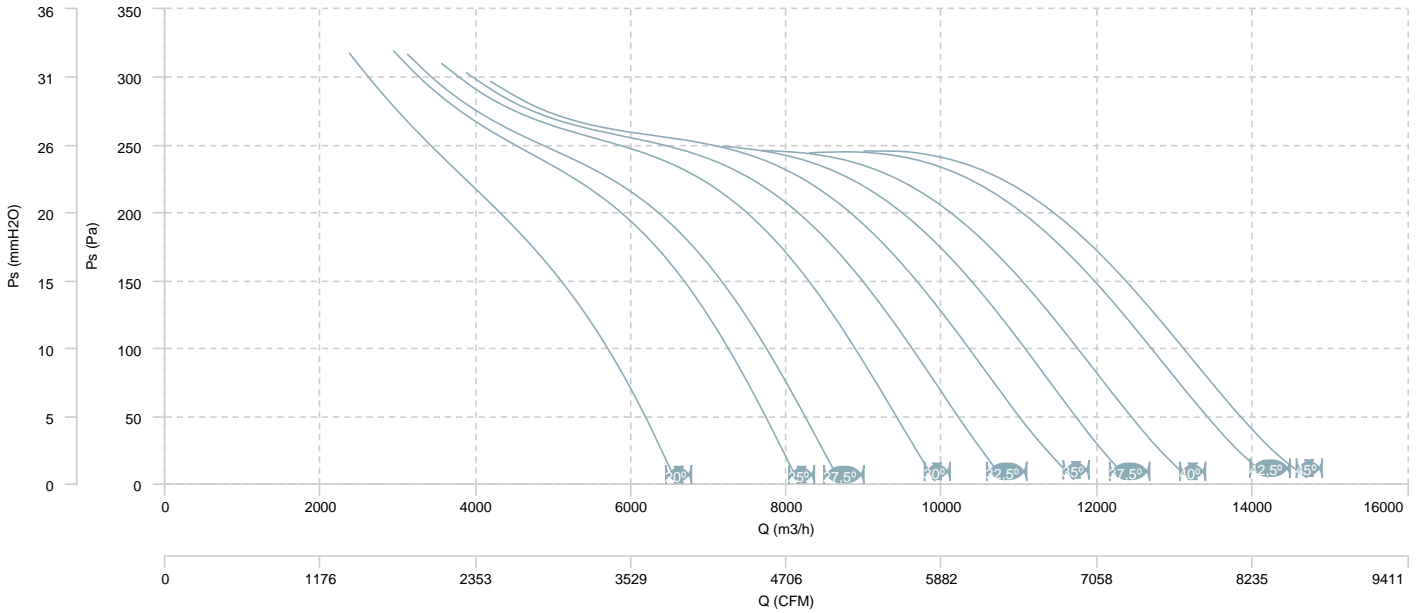

AIR FLOW - MECHANICAL POWER

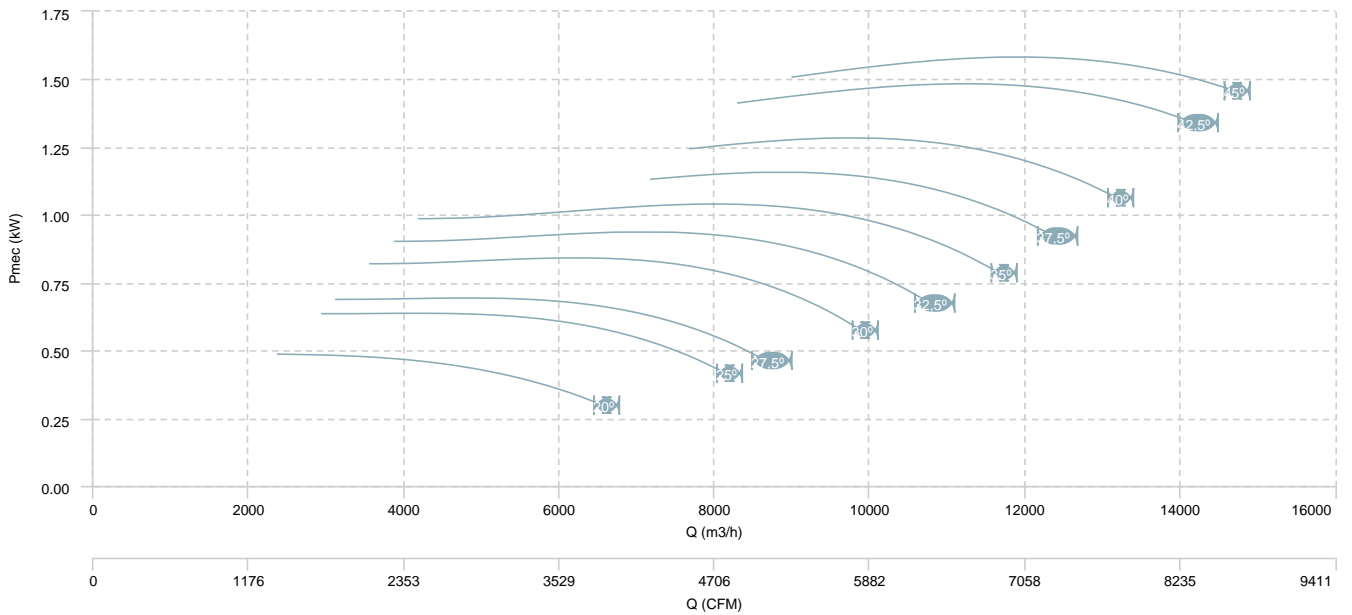

HC 56 T4 (A2:6)

AIR FLOW - PRESSURE

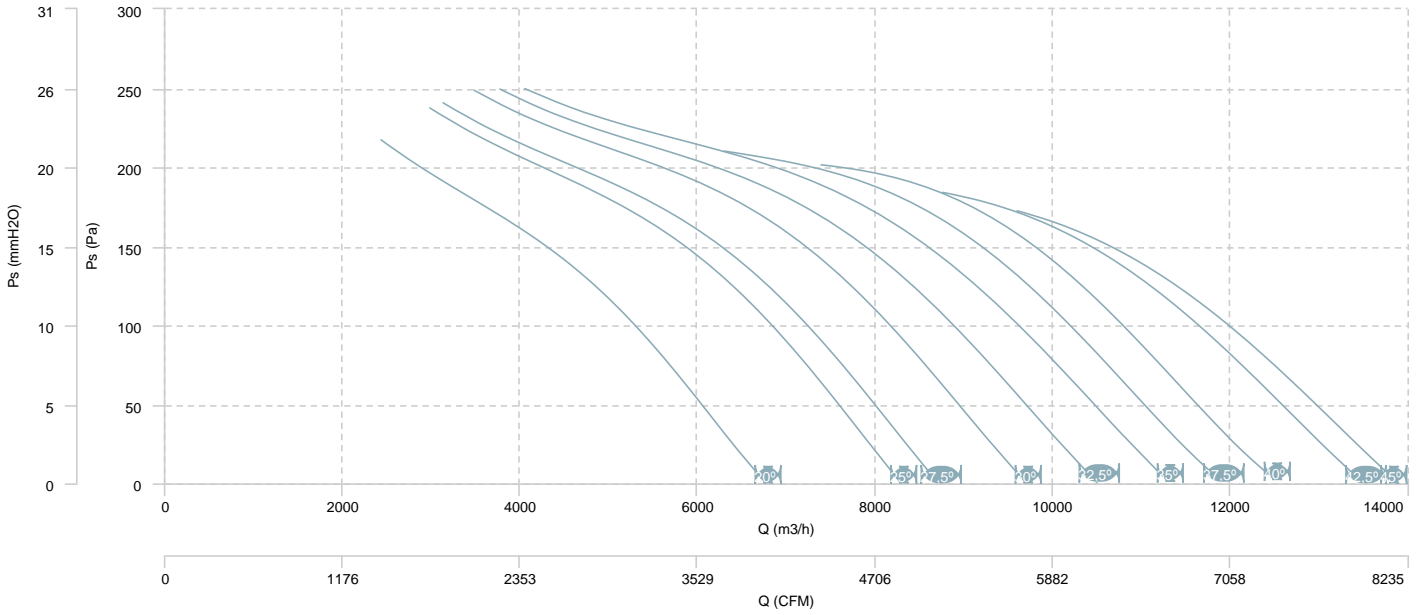

AIR FLOW - MECHANICAL POWER

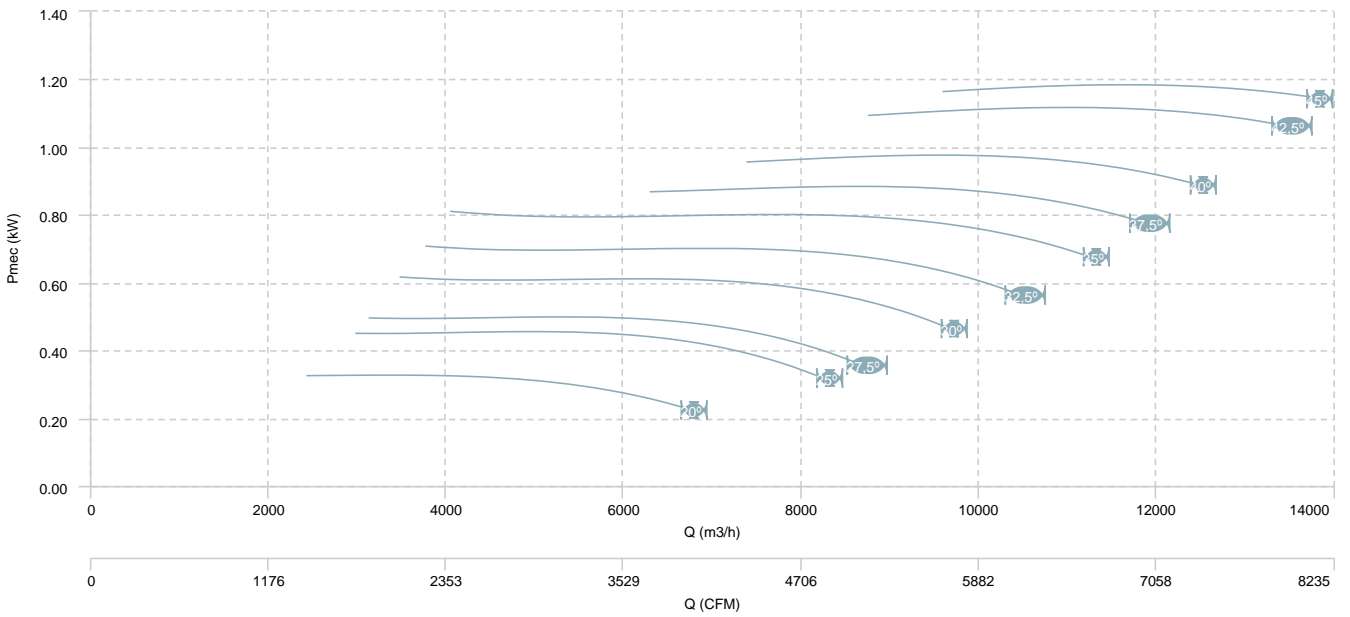

HC 56 T6 (A5:6)

AIR FLOW - PRESSURE

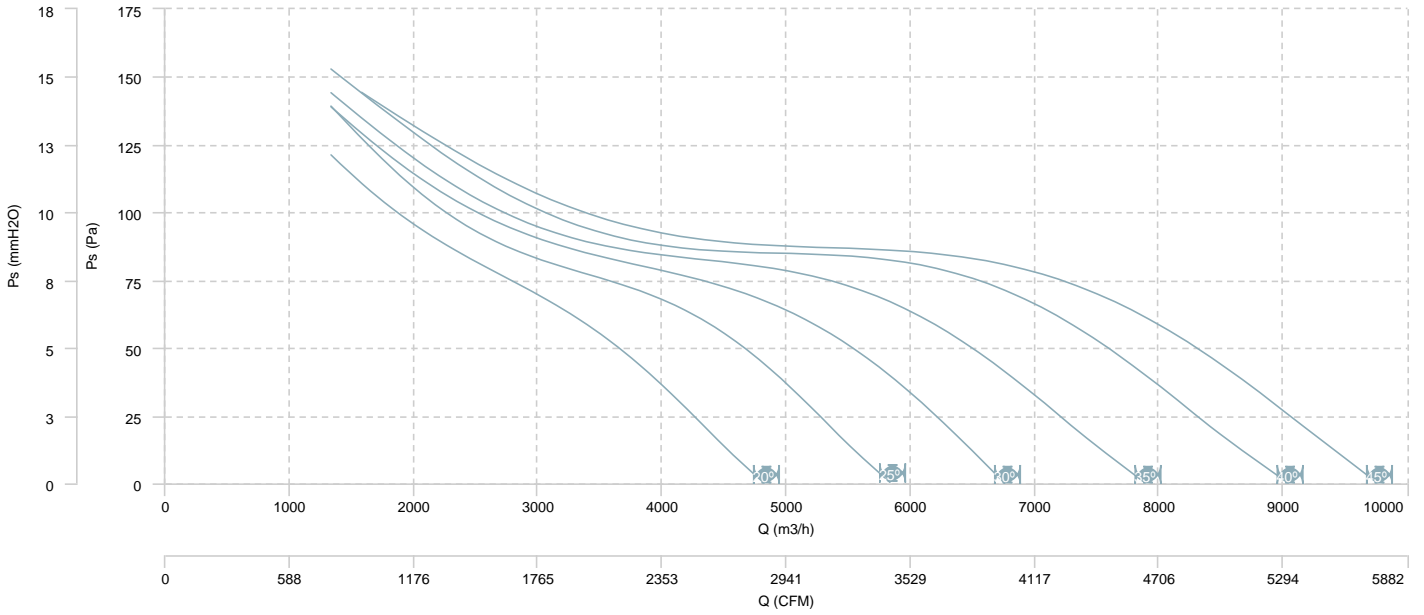

AIR FLOW - MECHANICAL POWER

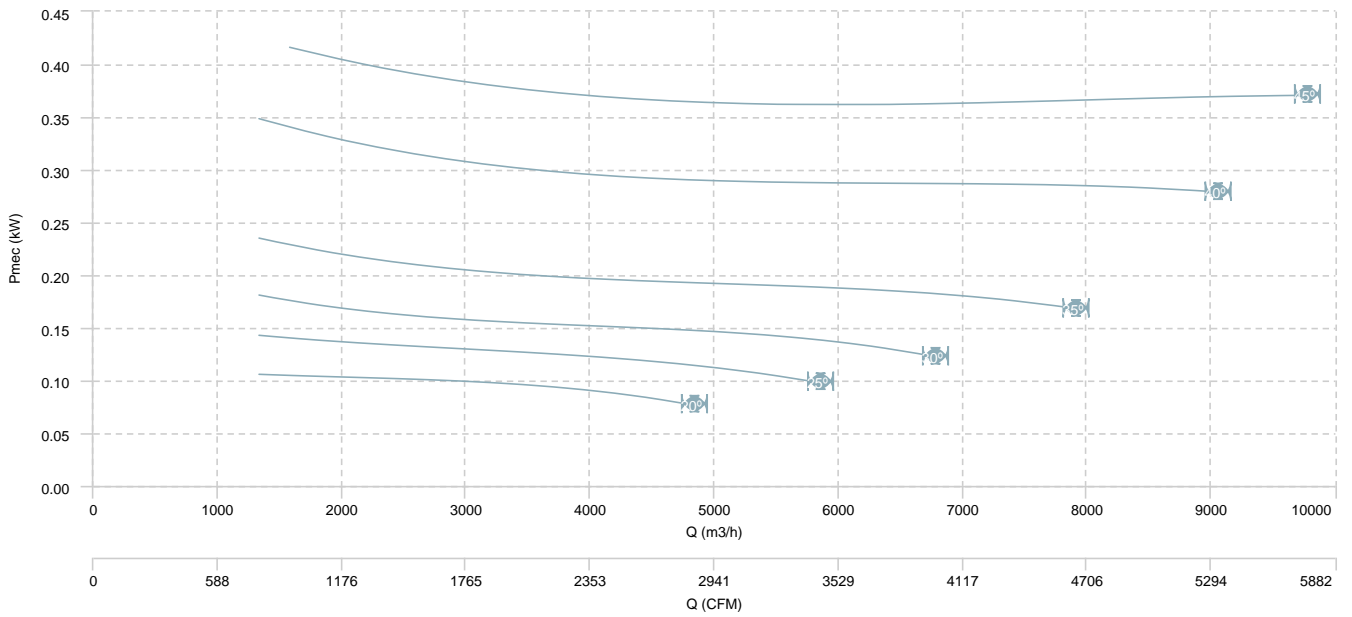

HC 56 T6 (A2:6)

AIR FLOW - PRESSURE

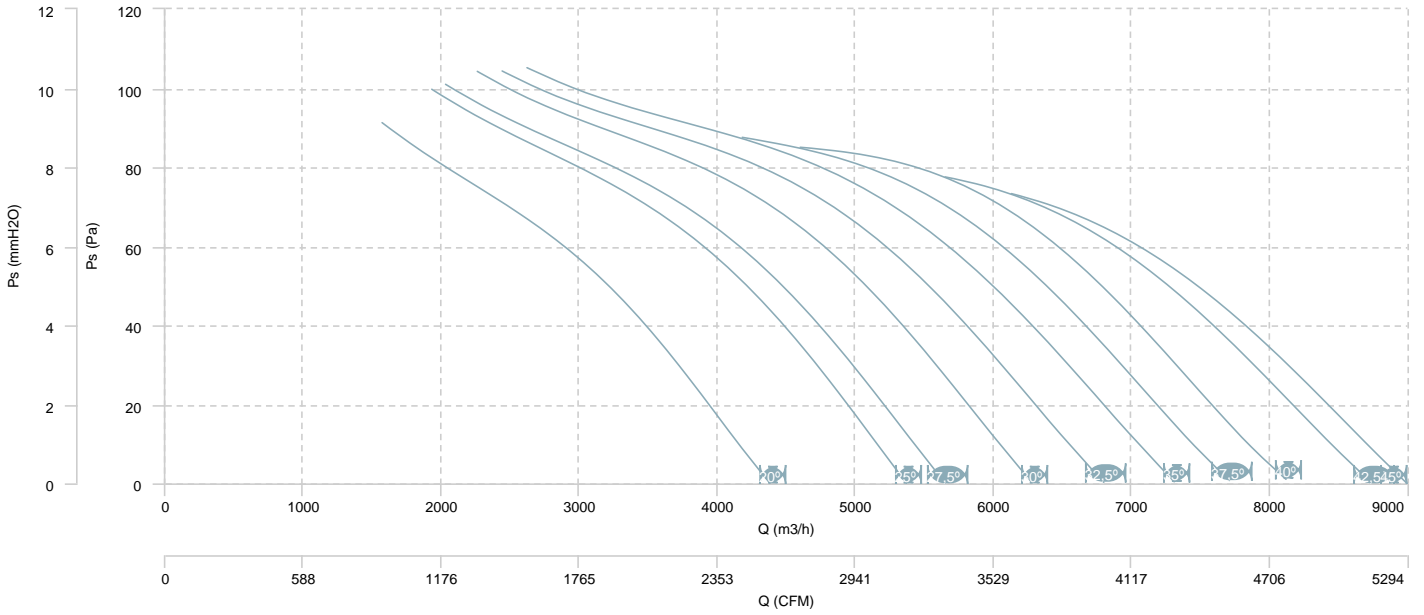

AIR FLOW - MECHANICAL POWER

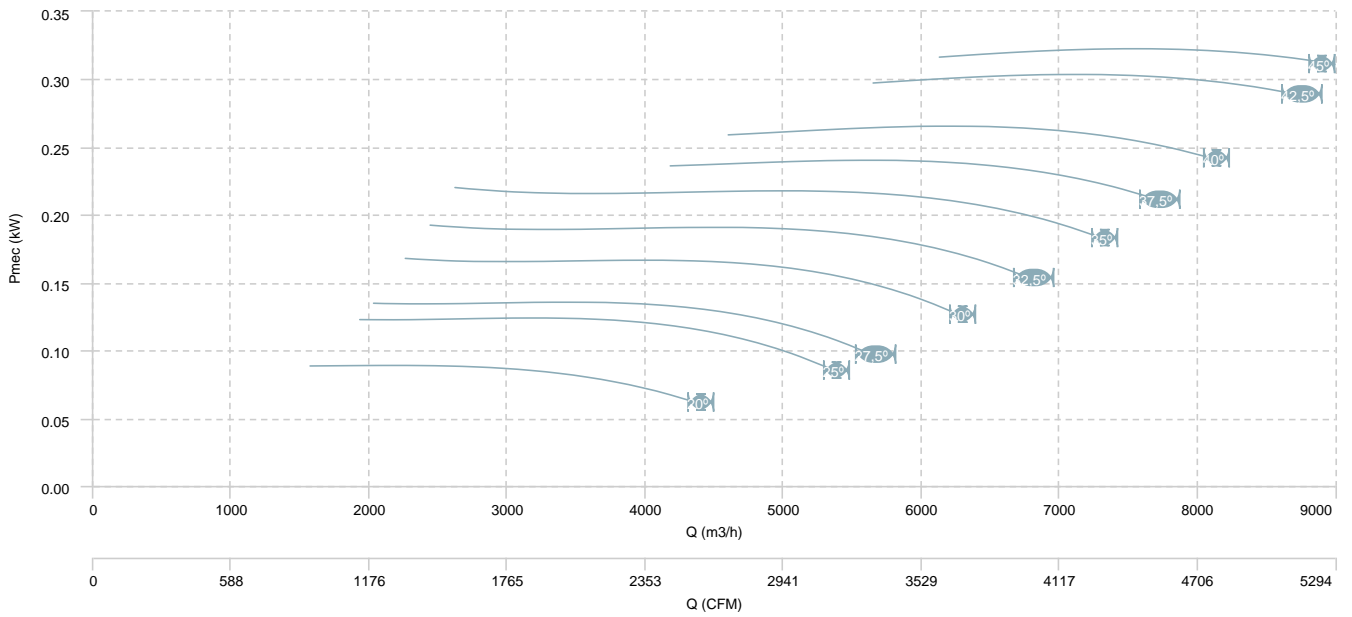

HC 56 T6 (A2:9)

AIR FLOW - PRESSURE

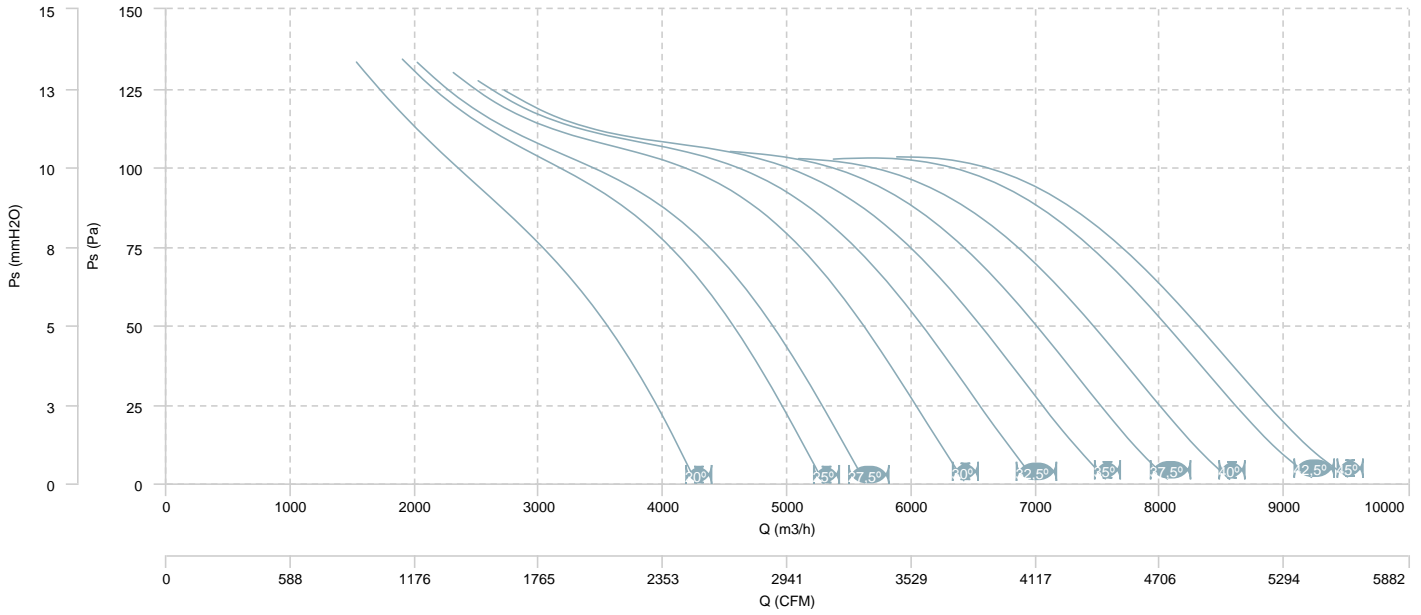

AIR FLOW - MECHANICAL POWER

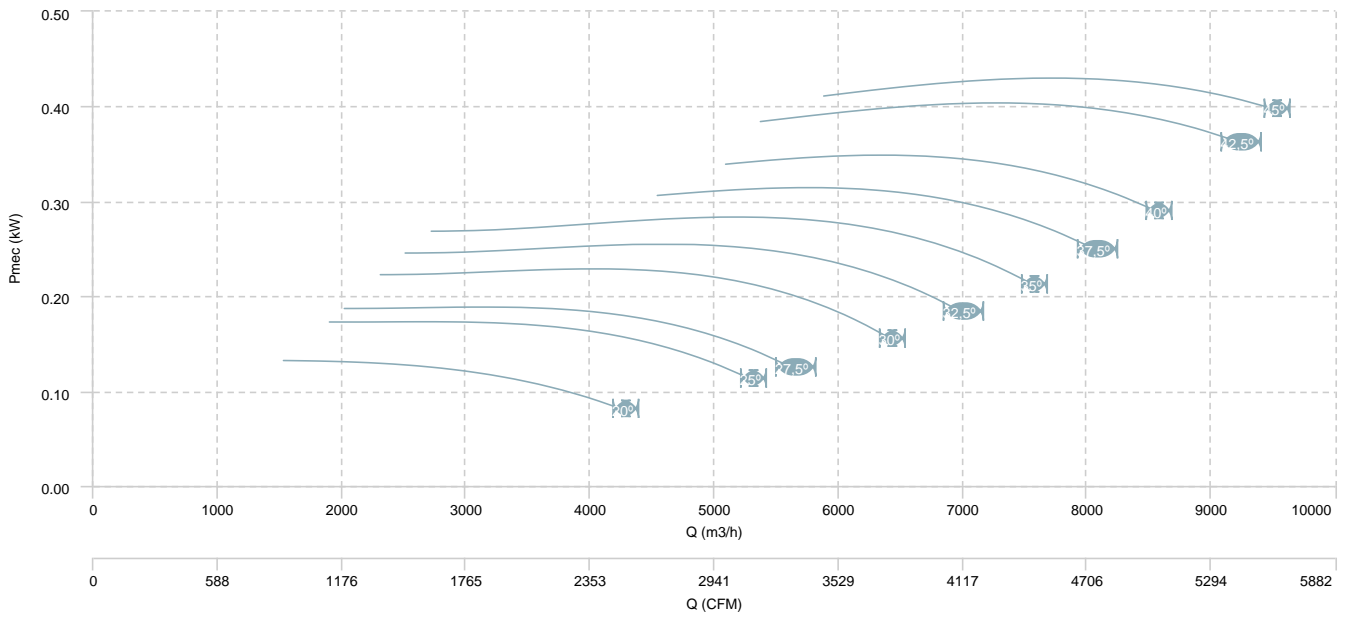

HC 56 T4/T8 (A2:6)

AIR FLOW - PRESSURE (4 poles)

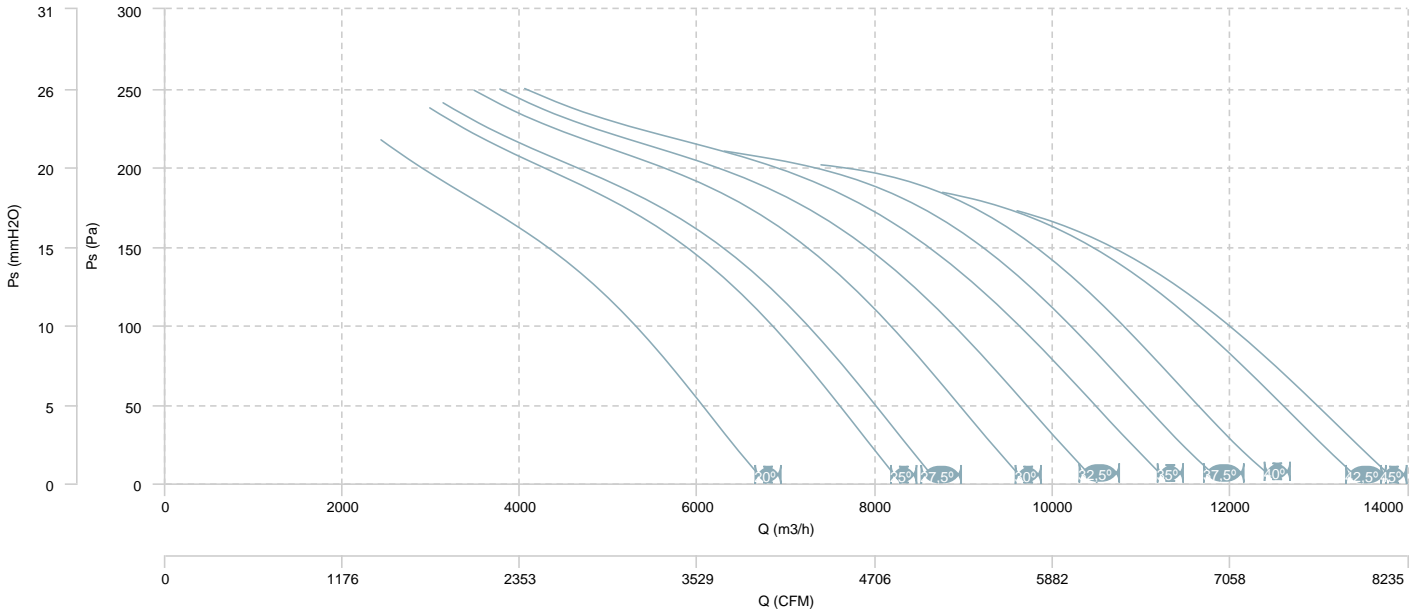

AIR FLOW - MECHANICAL POWER (4 poles)

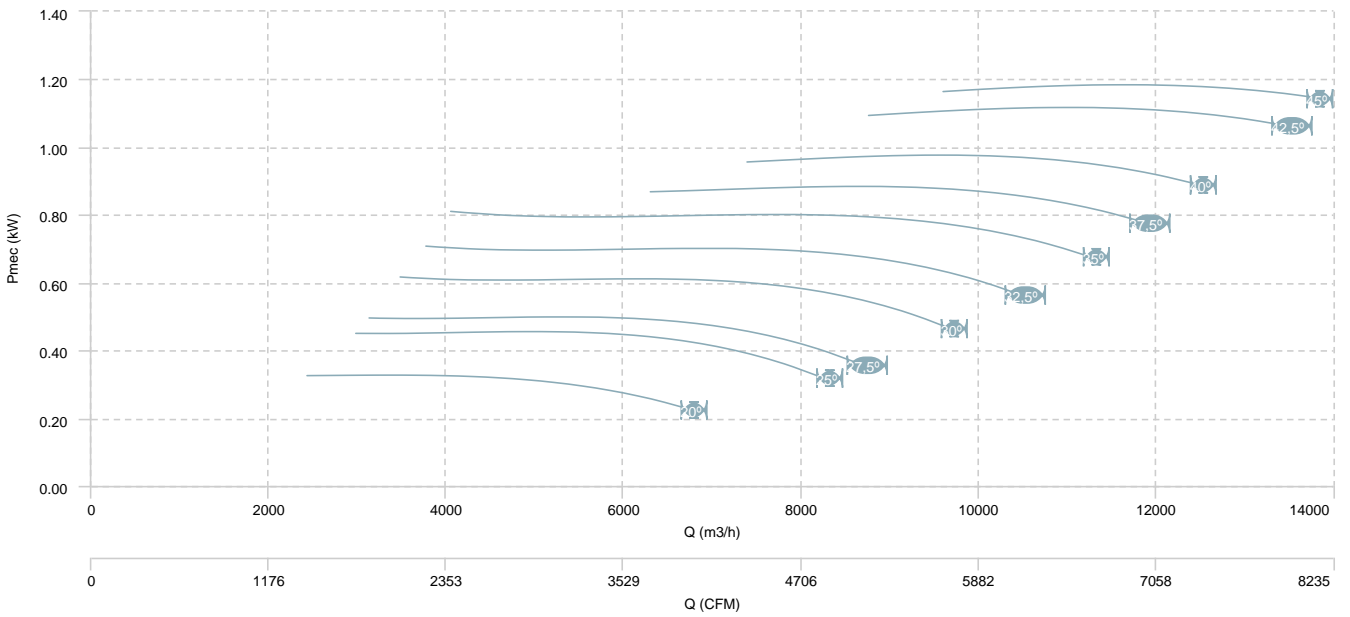

HC 56 T4/T8 (A2:6)

AIR FLOW - PRESSURE (8 poles)

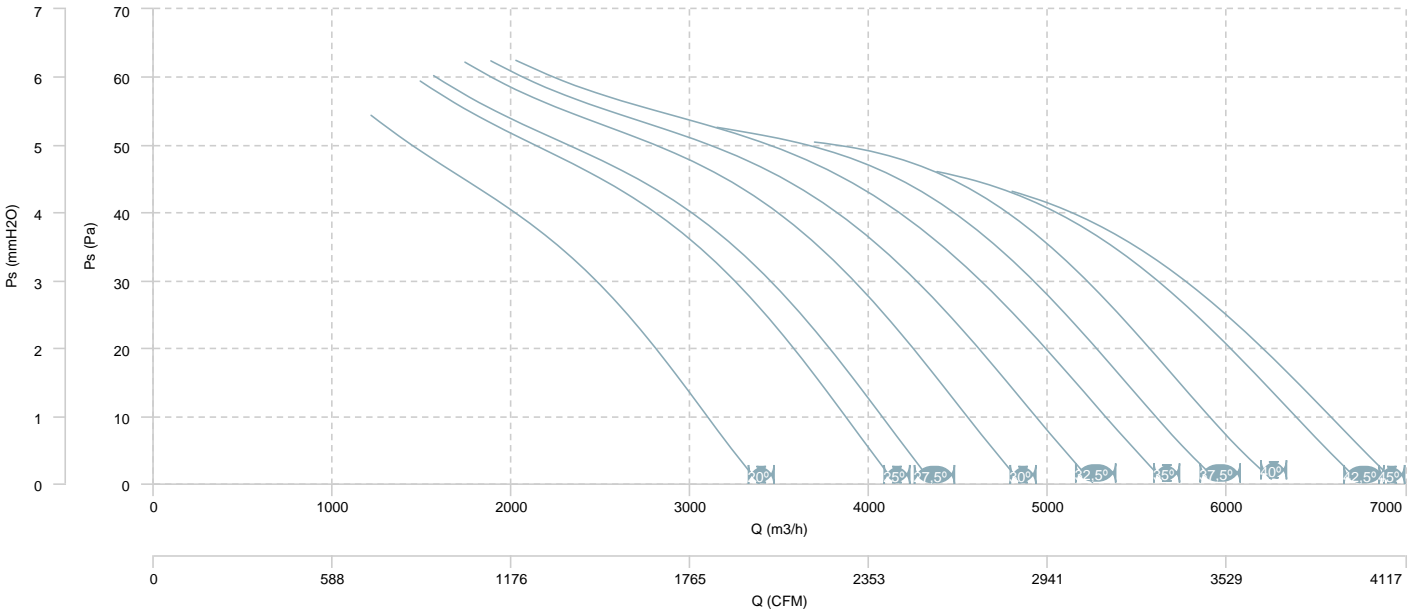

AIR FLOW - MECHANICAL POWER (8 poles)

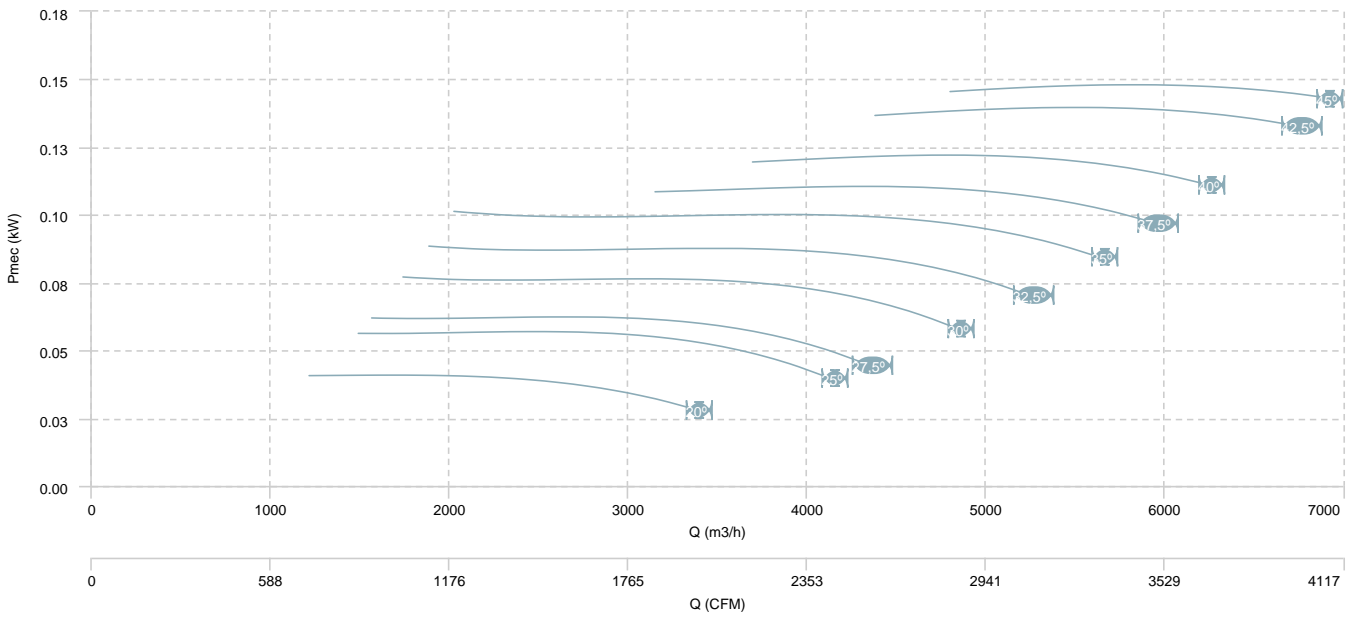

HC 56 T4/T8 (A2:9)

AIR FLOW - PRESSURE (4 poles)

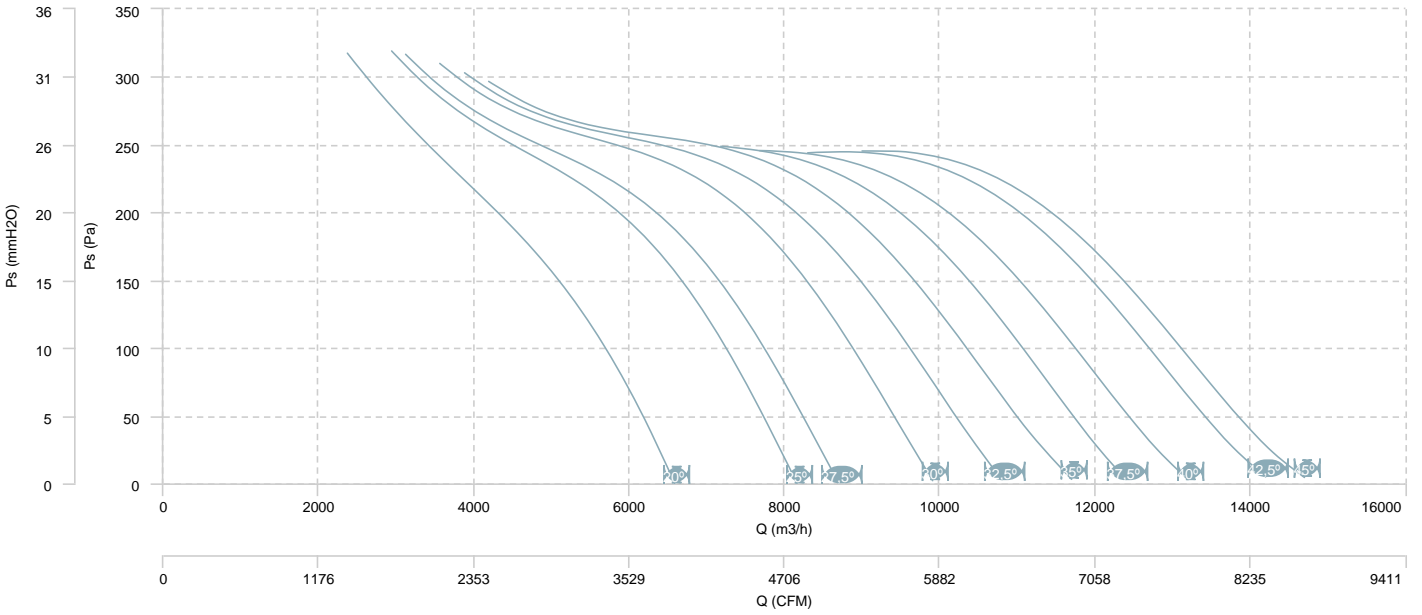

AIR FLOW - MECHANICAL POWER (4 poles)

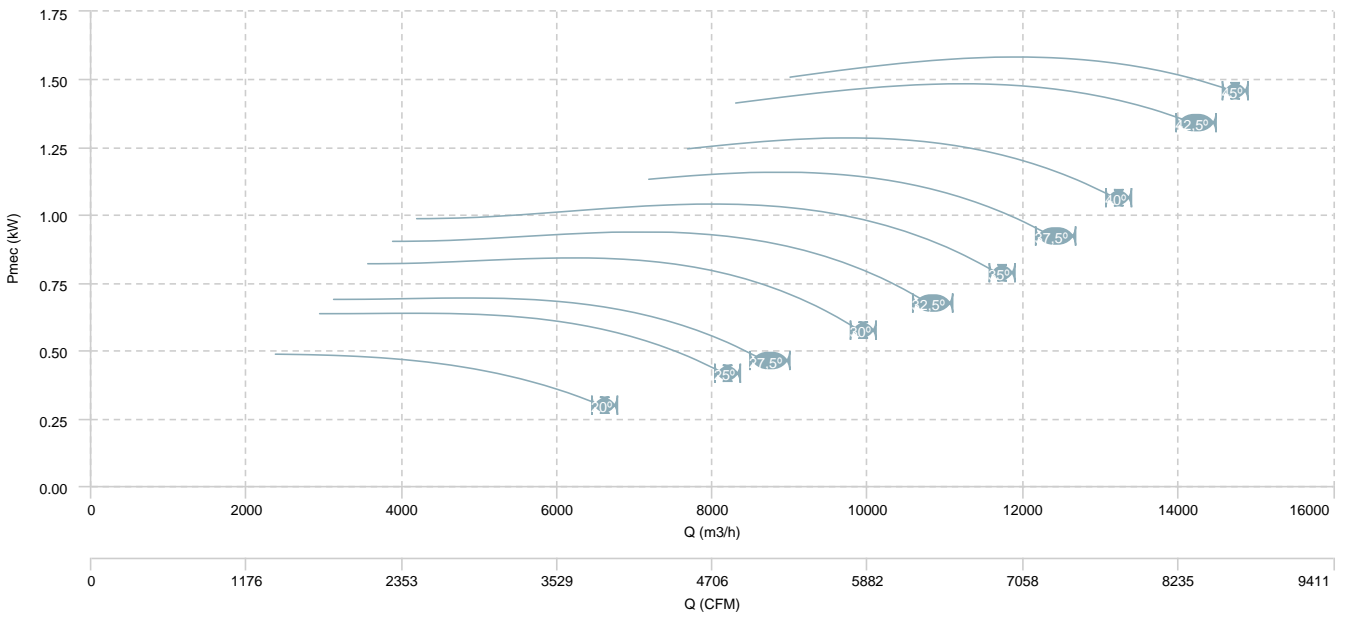

HC 56 T4/T8 (A2:9)

AIR FLOW - PRESSURE (8 poles)

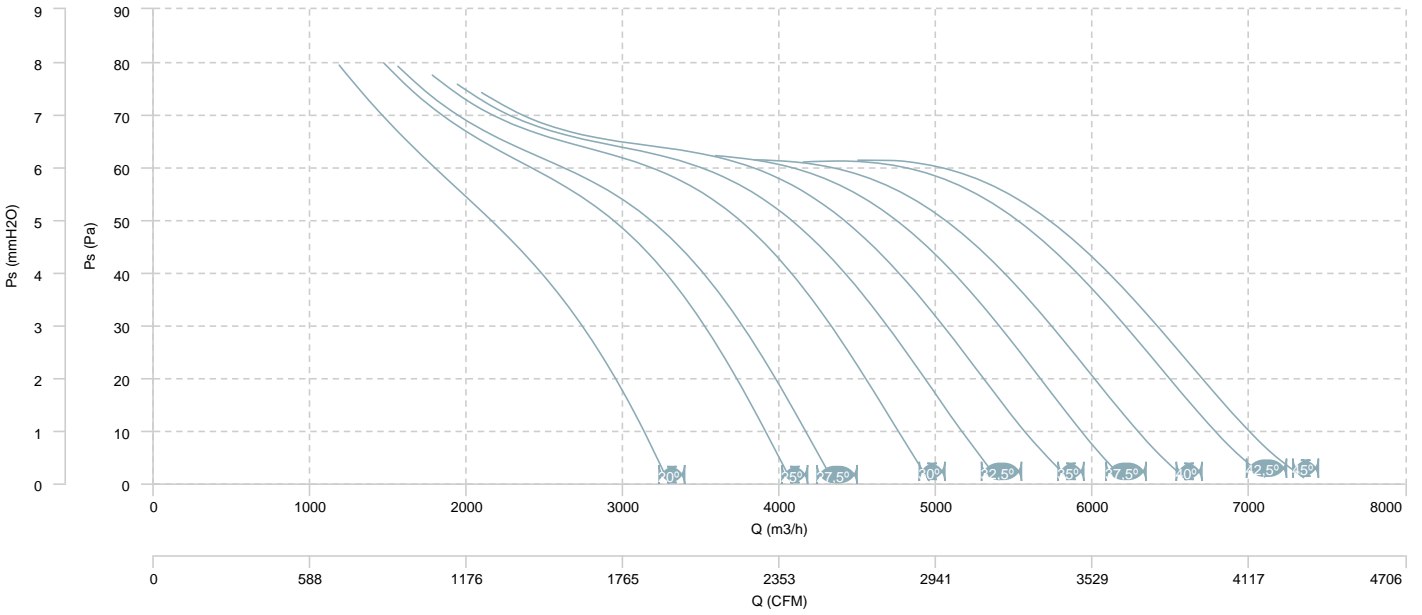

AIR FLOW - MECHANICAL POWER (8 poles)

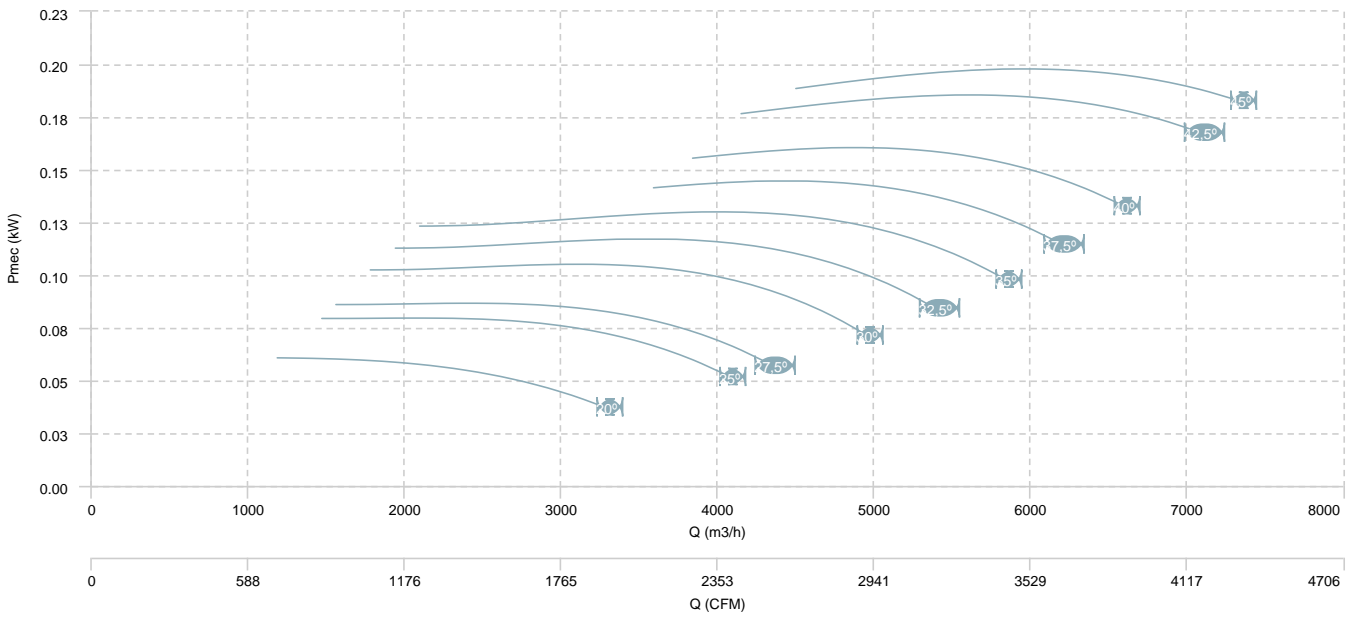

HC 56 T4/T8 (A5:6)

AIR FLOW - PRESSURE (4 poles)

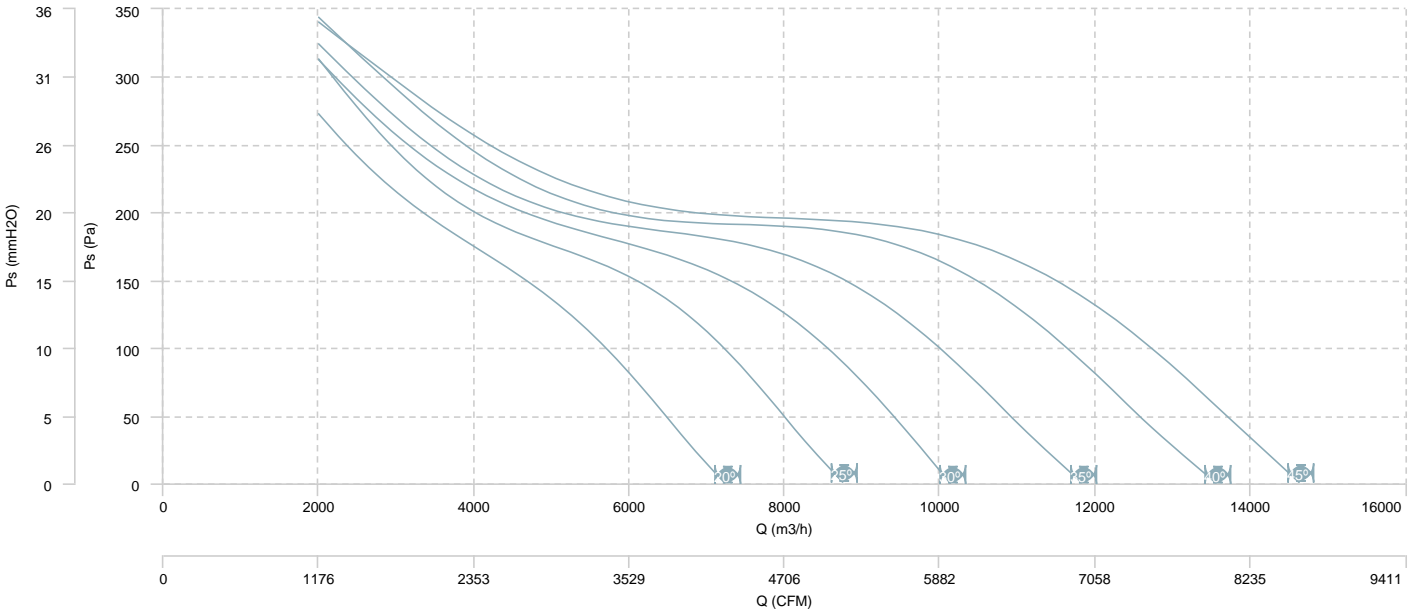

AIR FLOW - MECHANICAL POWER (4 poles)

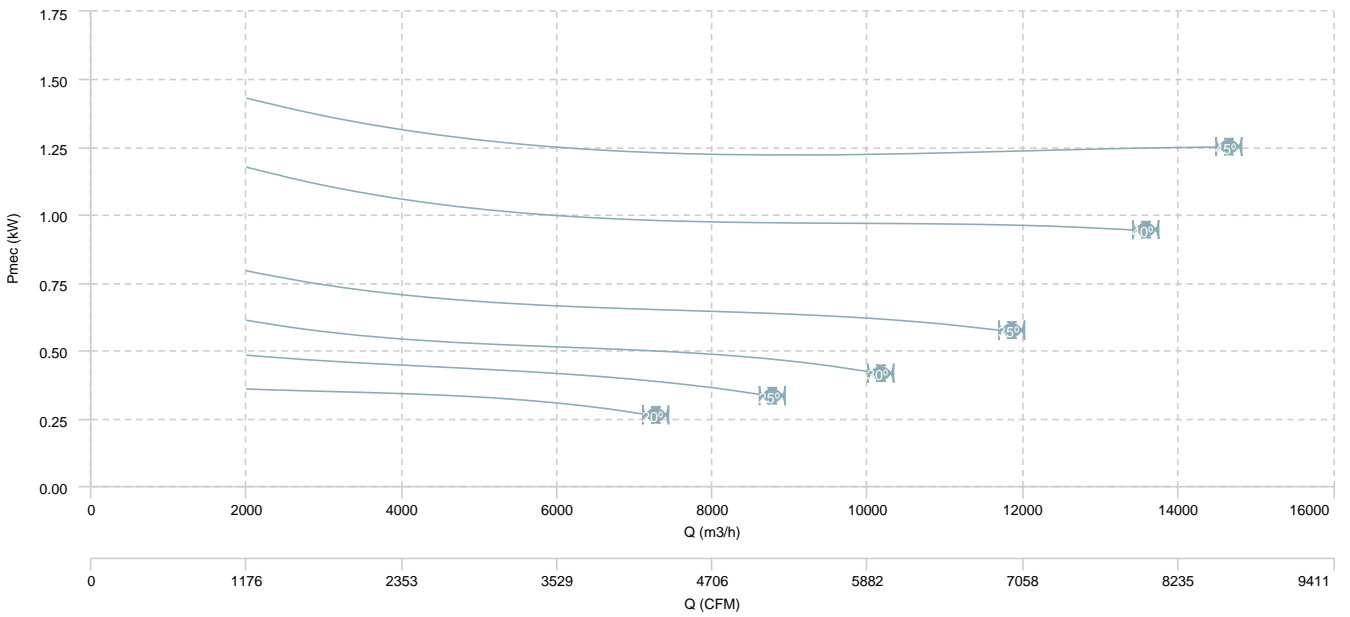

HC 56 T4/T8 (A5:6)

AIR FLOW - PRESSURE (8 poles)

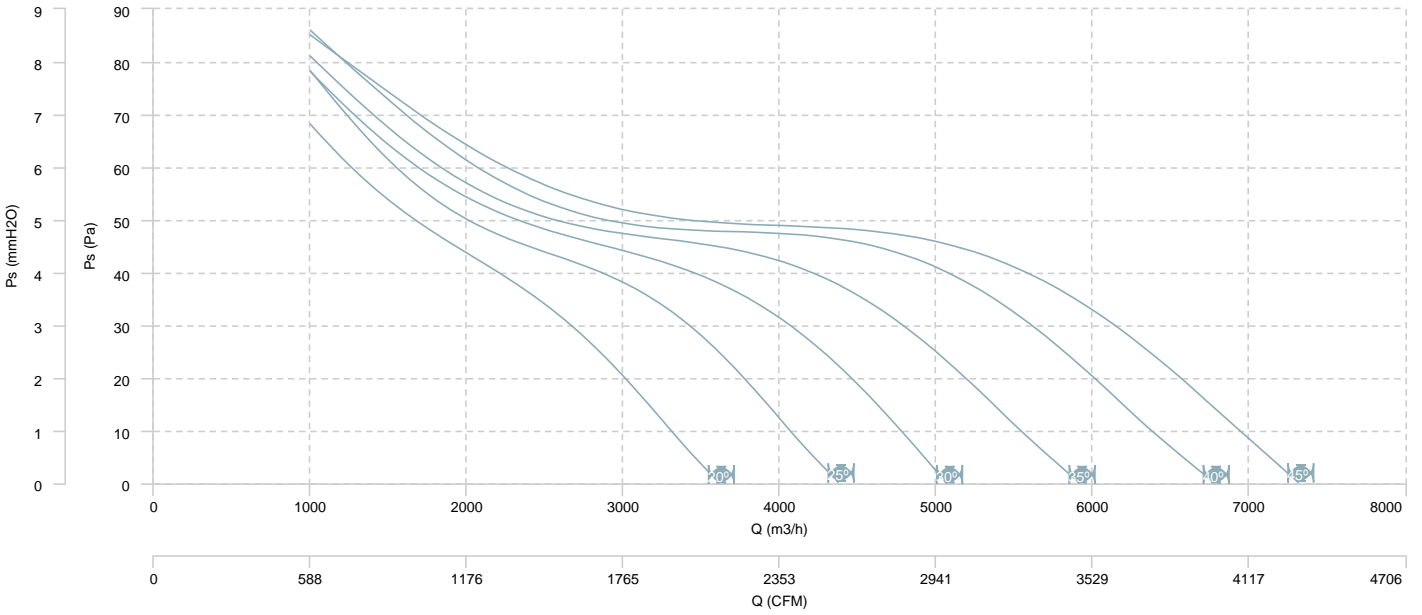

AIR FLOW - MECHANICAL POWER (8 poles)

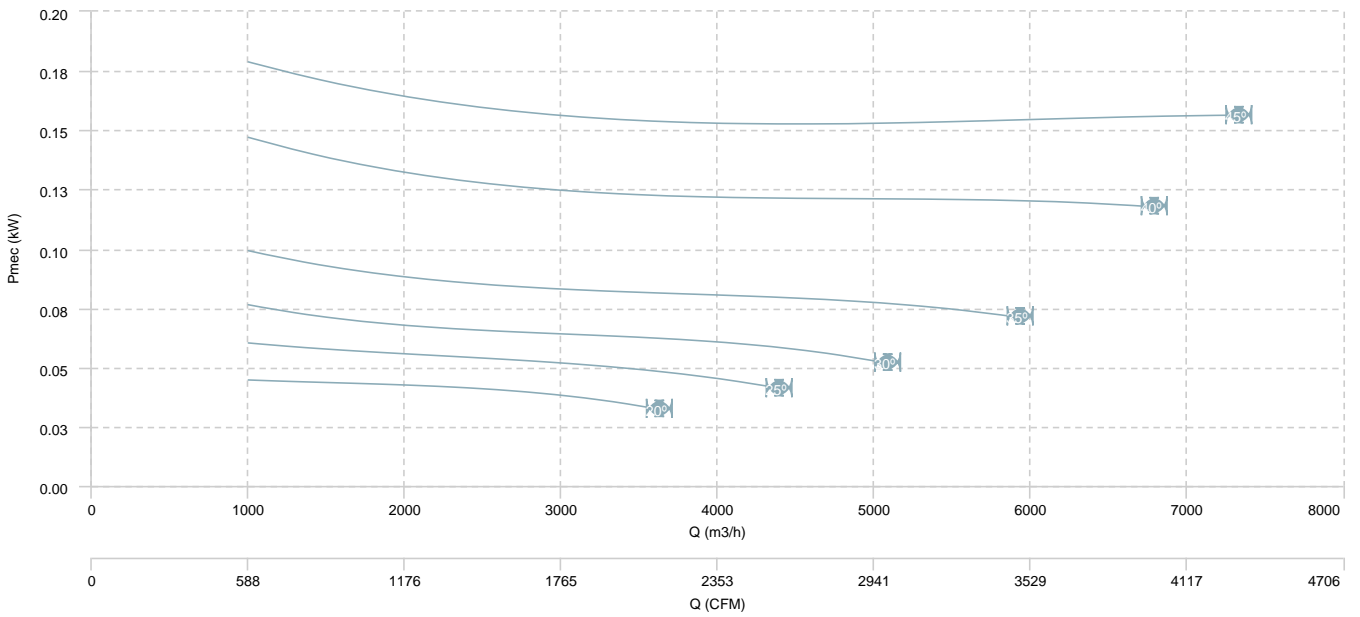

HC 63 T4 (A5:6)

AIR FLOW - PRESSURE

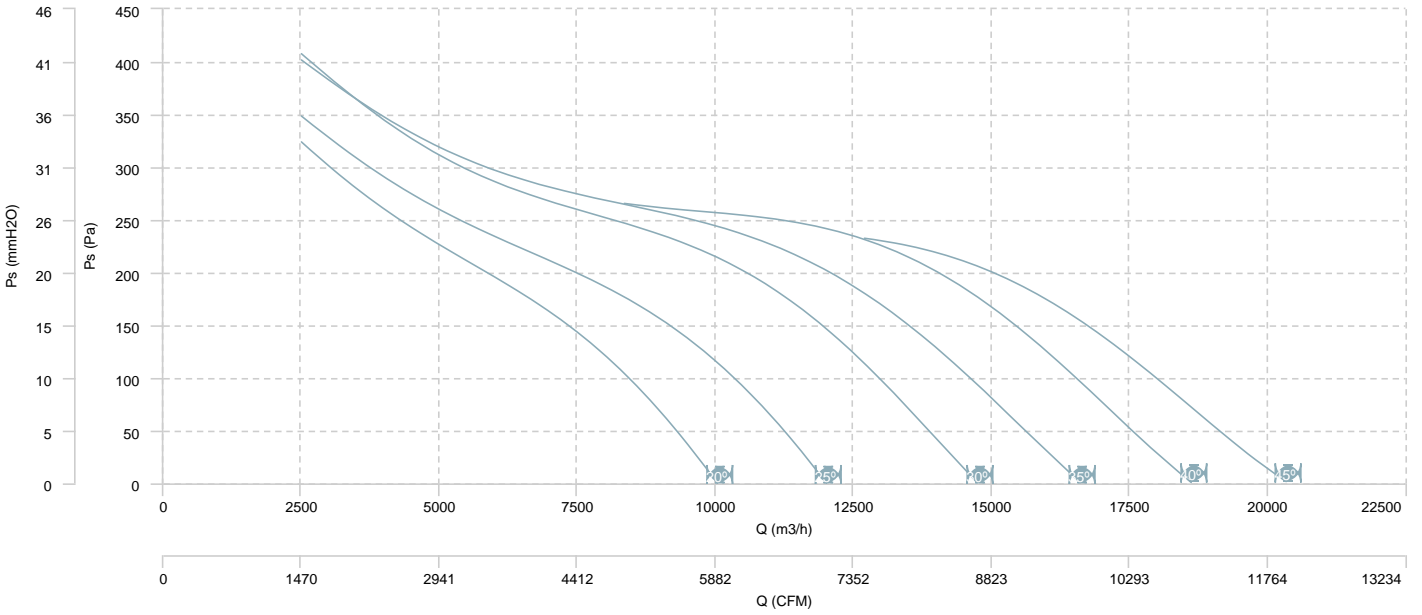

AIR FLOW - MECHANICAL POWER

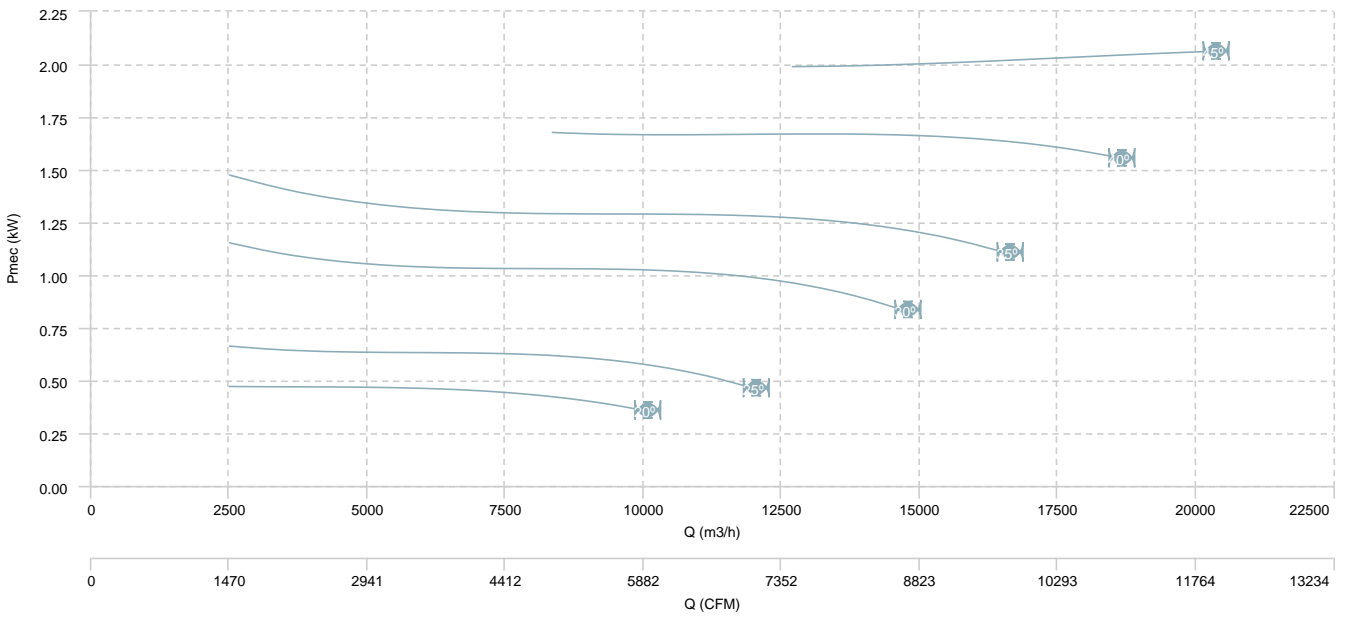

HC 63 T4 (A2:9)

AIR FLOW - PRESSURE

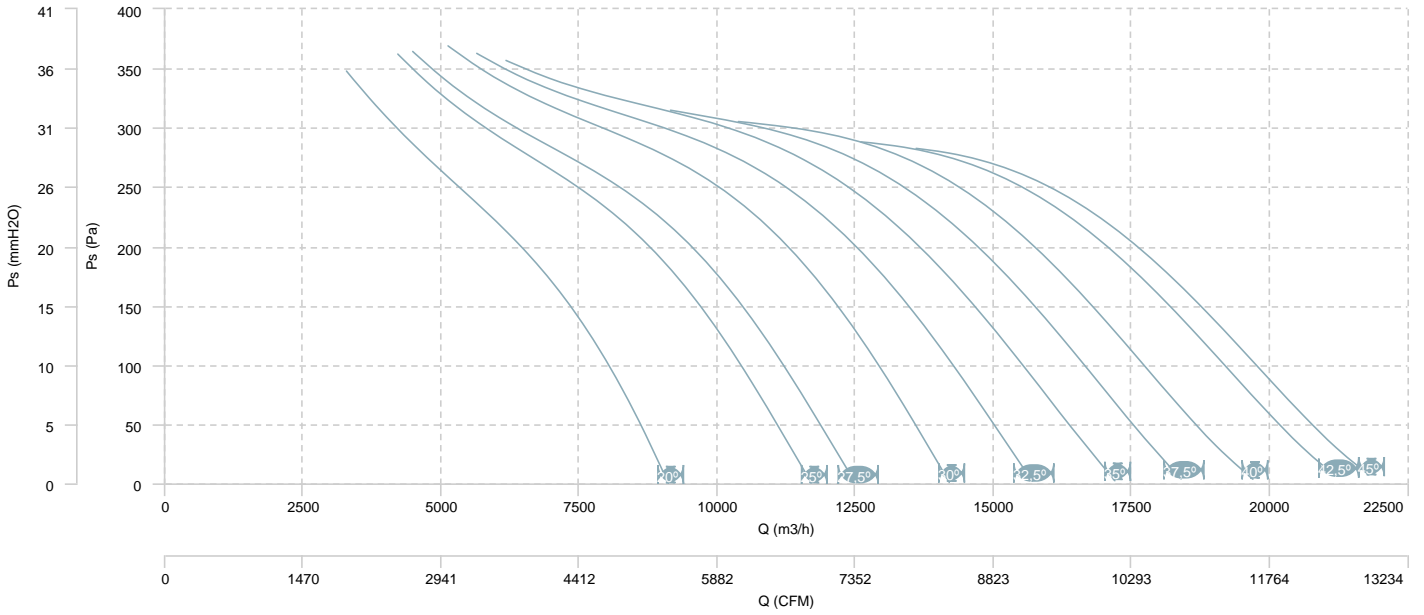

AIR FLOW - MECHANICAL POWER

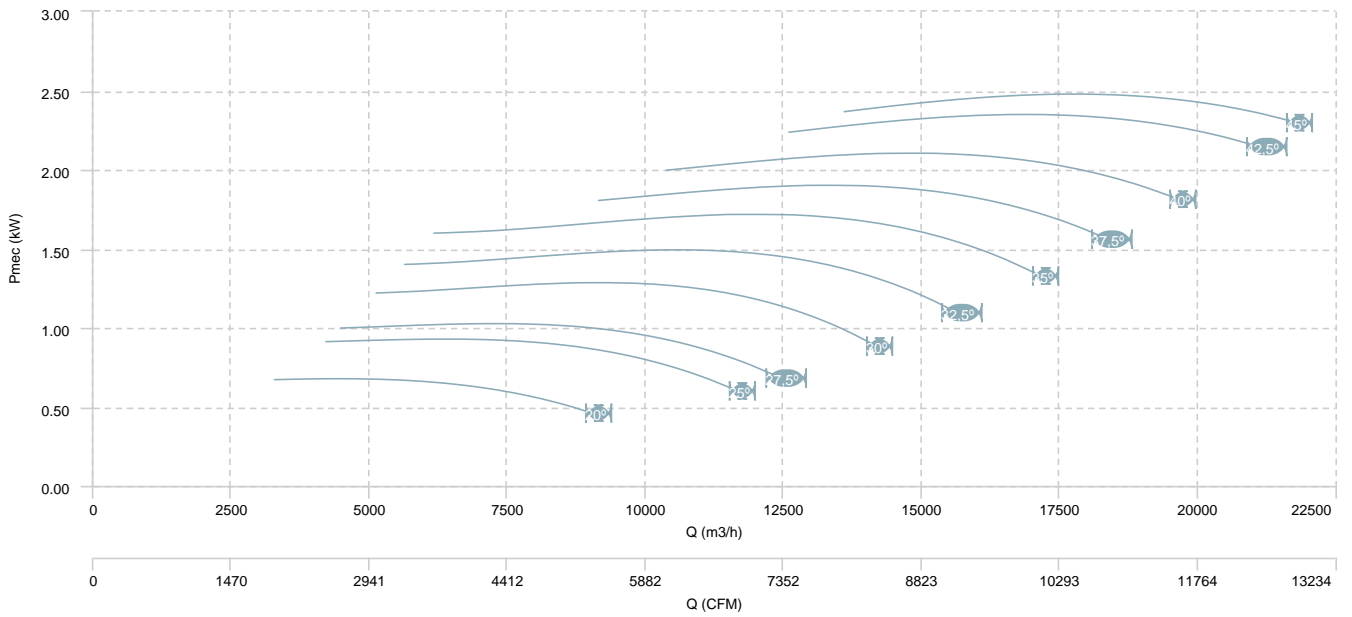

HC 63 T4 (A2:6)

AIR FLOW - PRESSURE

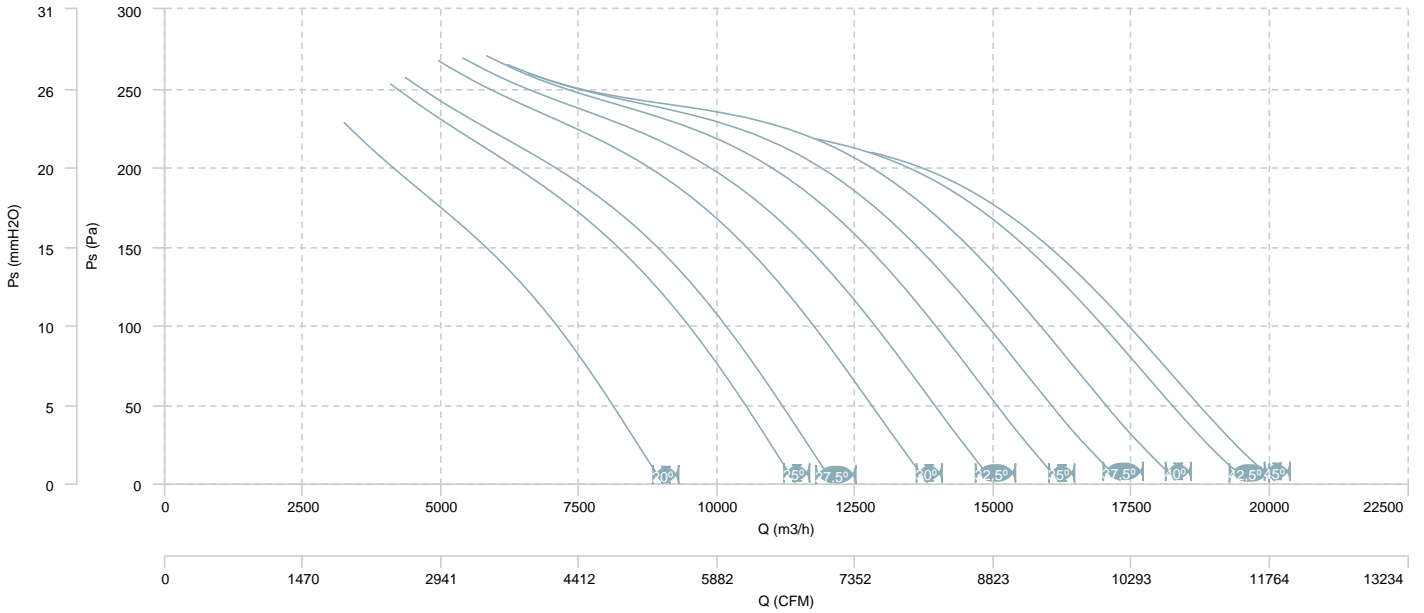

AIR FLOW - MECHANICAL POWER

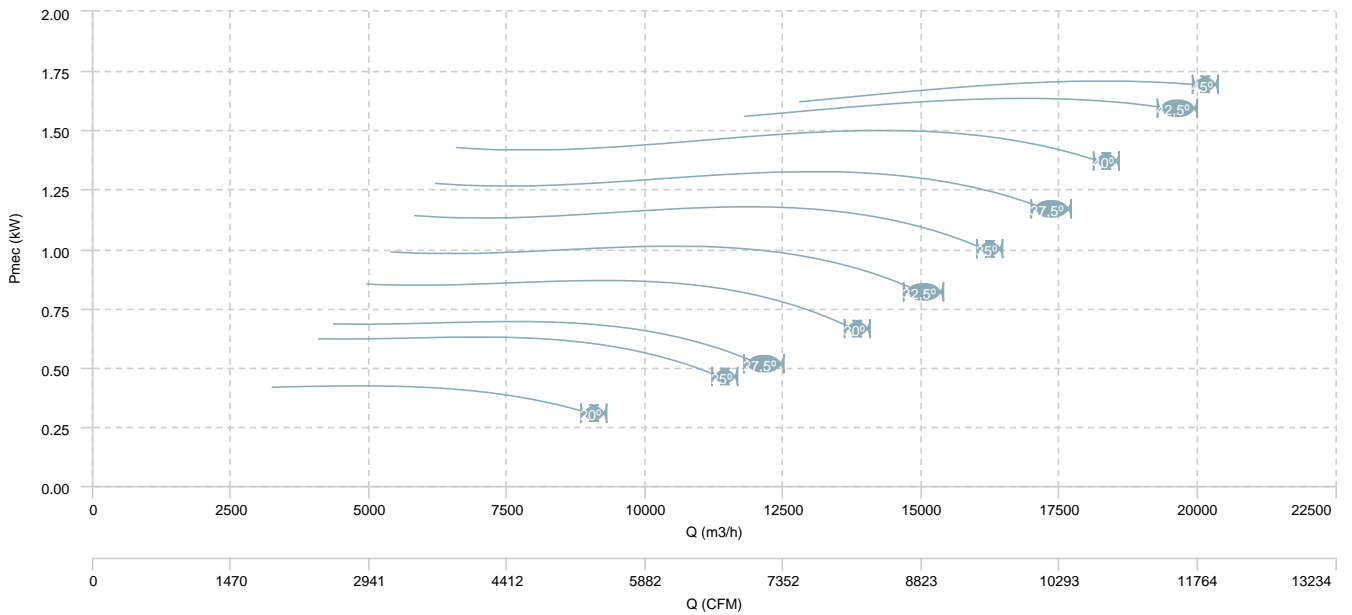

HC 63 T6 (A2:6)

AIR FLOW - PRESSURE

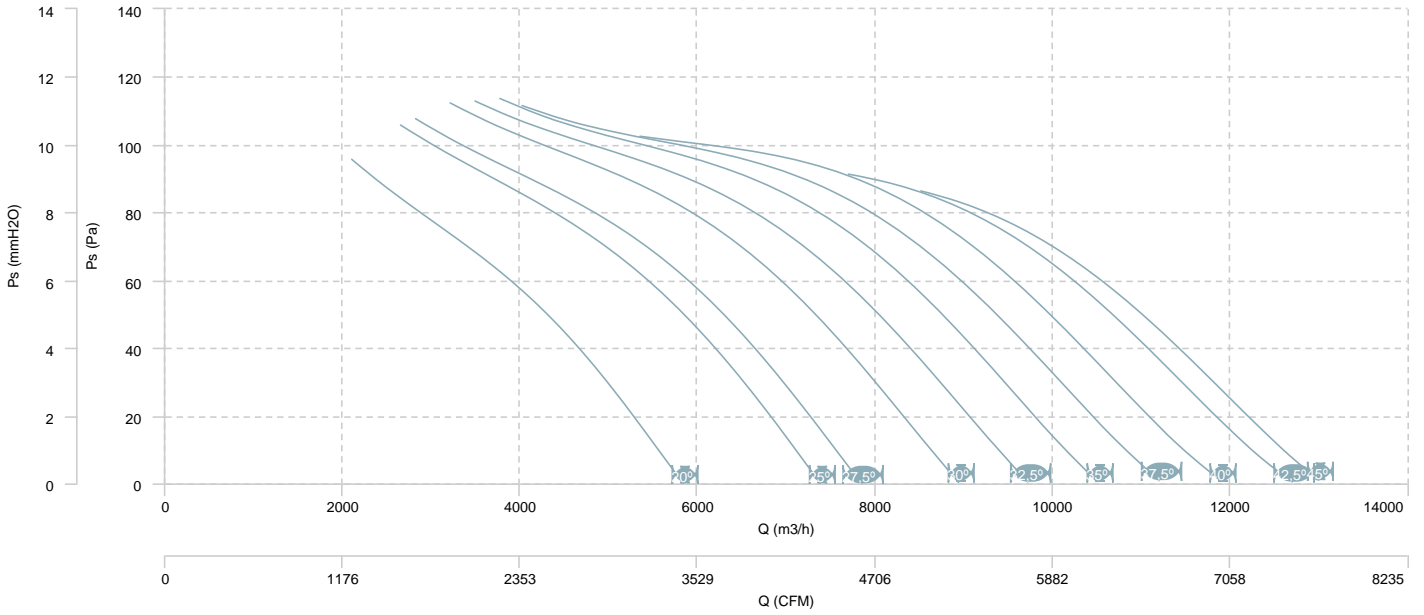

AIR FLOW - MECHANICAL POWER

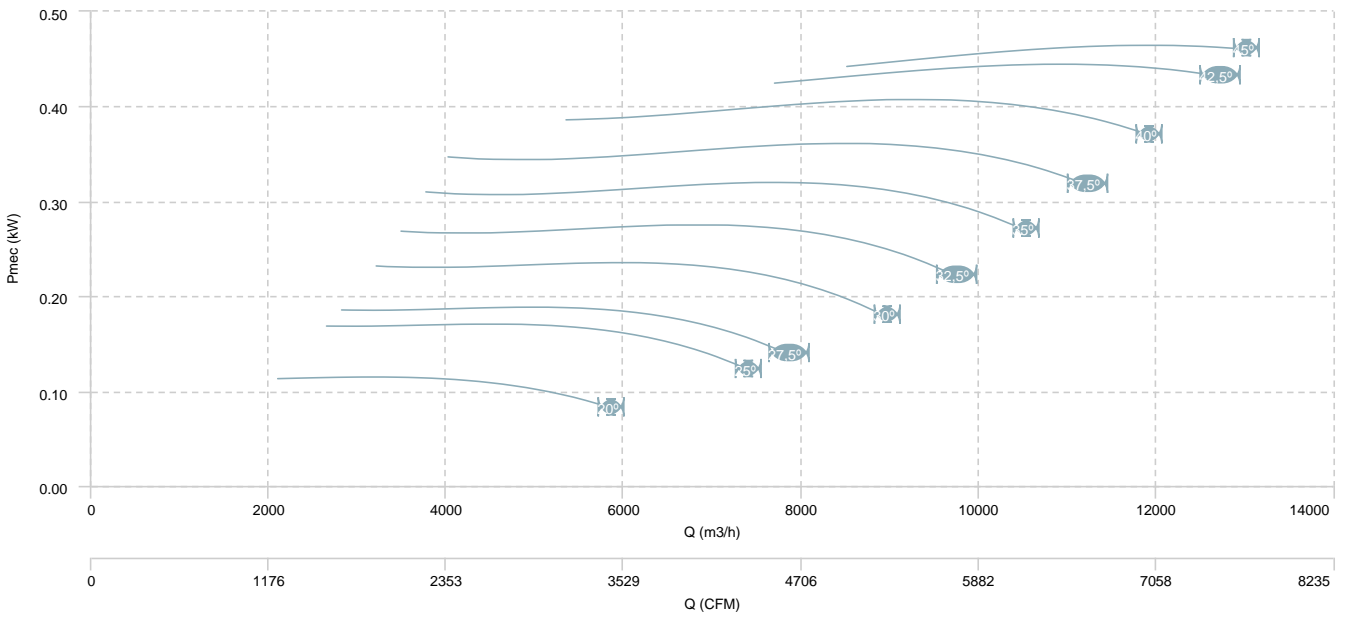

HC 63 T6 (A5:6)

AIR FLOW - PRESSURE

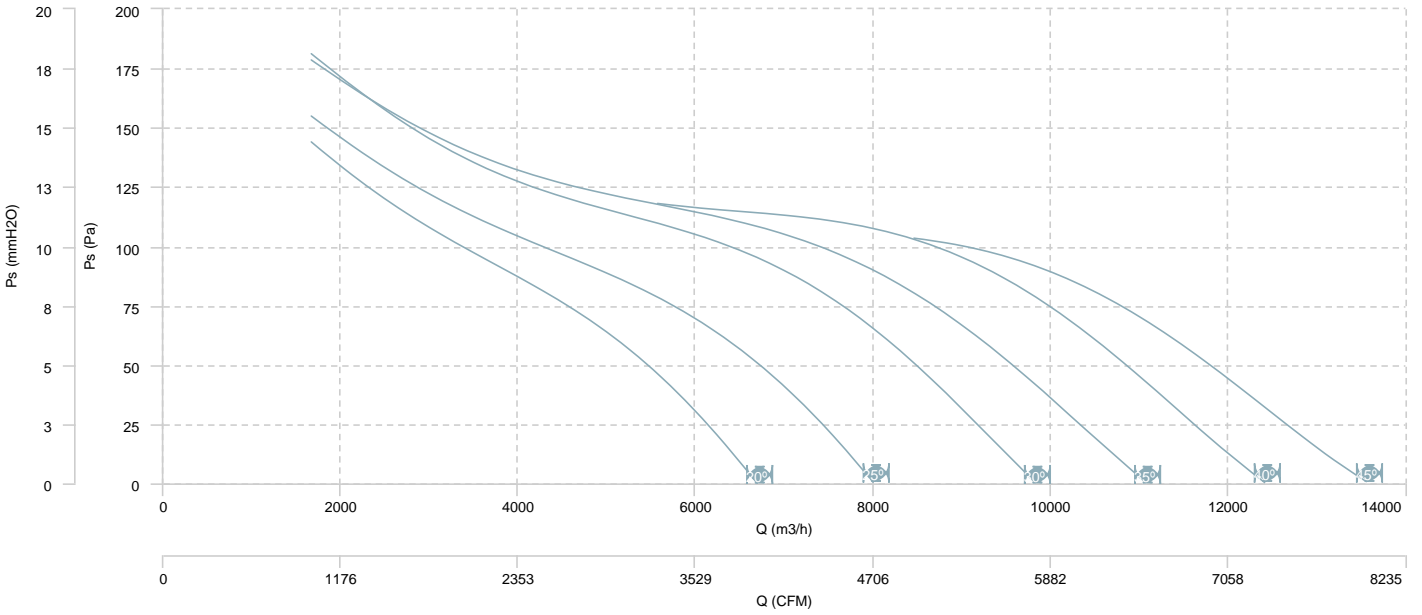

AIR FLOW - MECHANICAL POWER

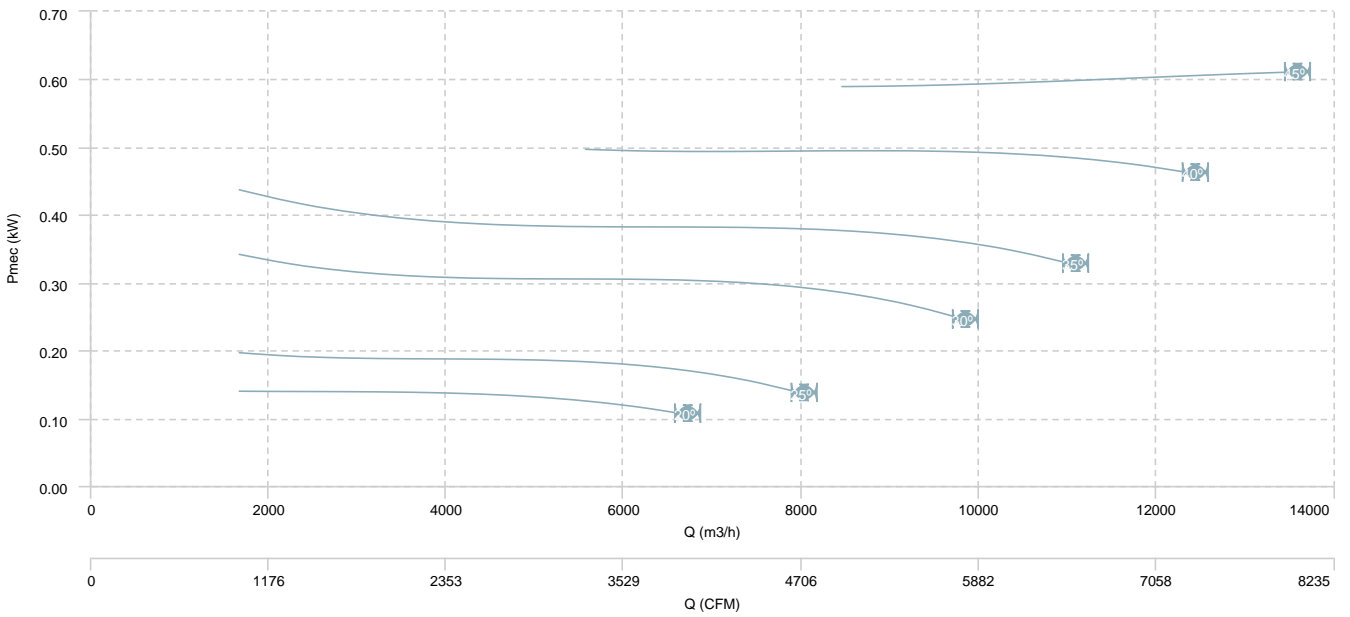

HC 63 T6 (A2:9)

AIR FLOW - PRESSURE

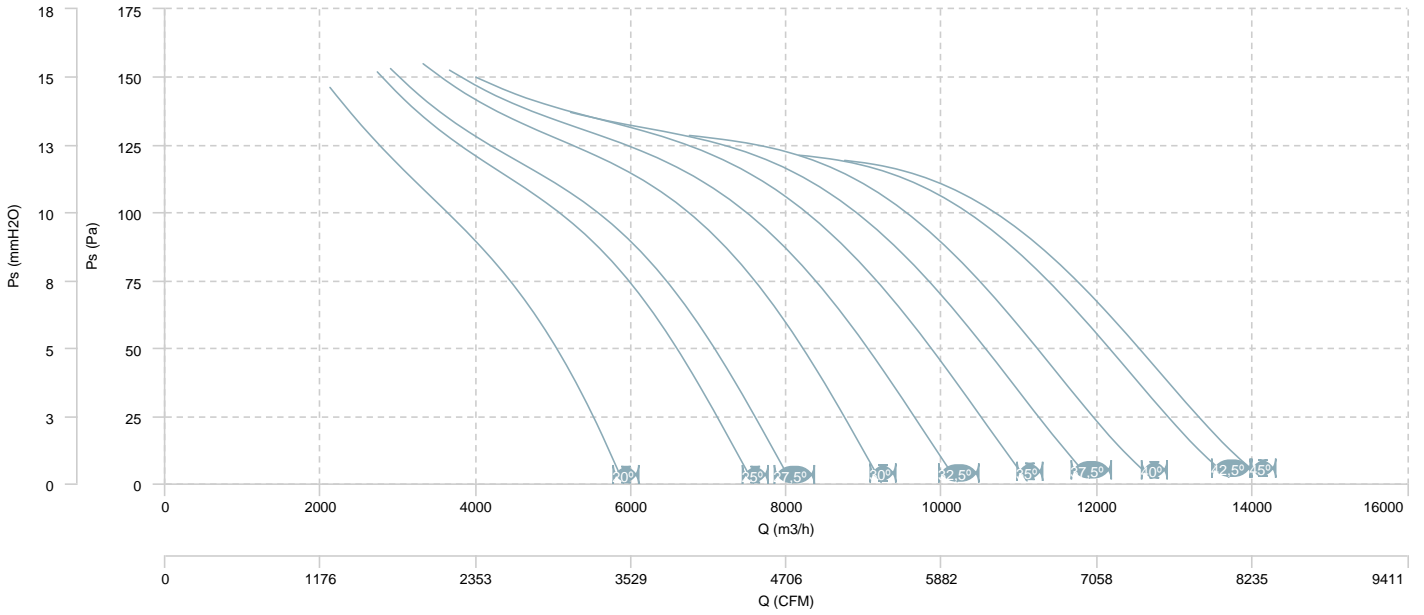

AIR FLOW - MECHANICAL POWER

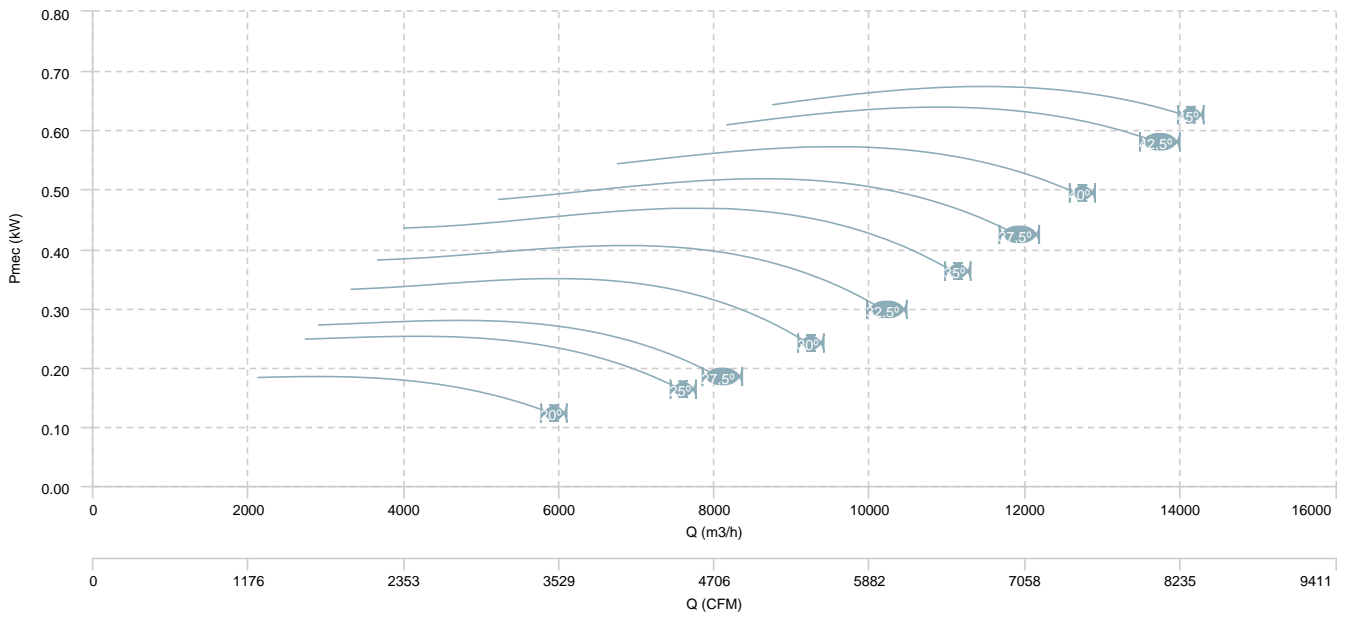

HC 63 T4/T8 (A2:6)

AIR FLOW - PRESSURE (4 poles)

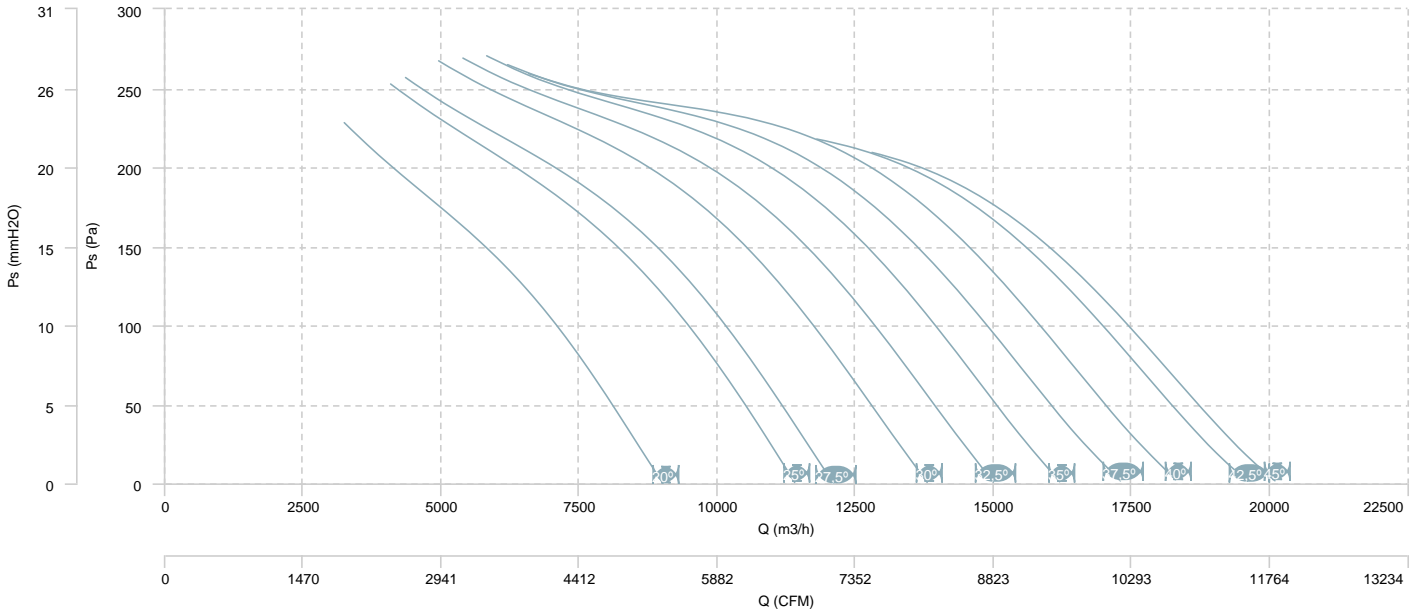

AIR FLOW - MECHANICAL POWER (4 poles)

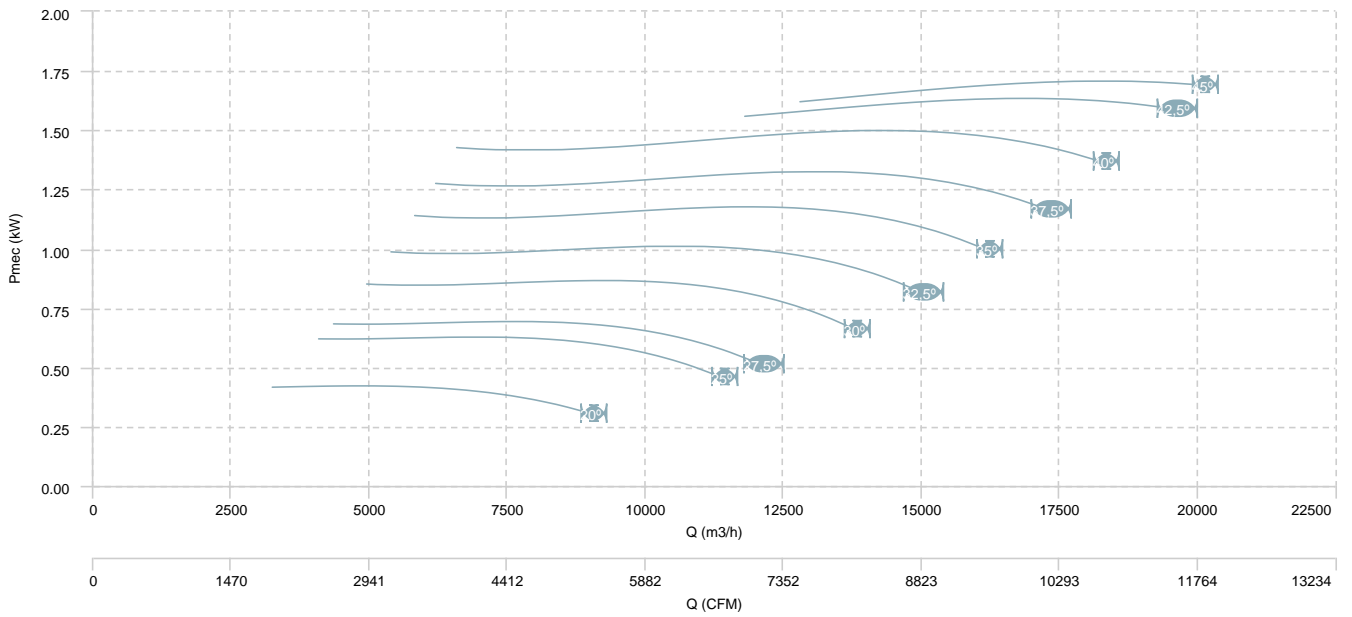

HC 63 T4/T8 (A2:6)

AIR FLOW - PRESSURE (8 poles)

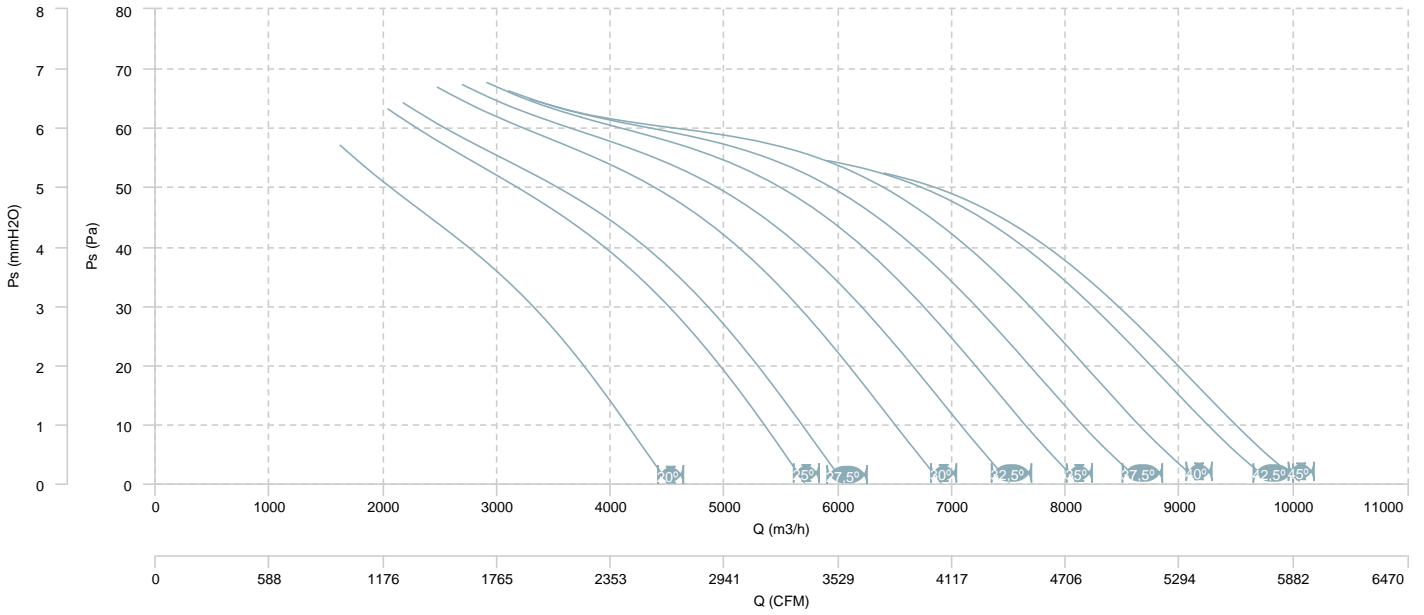

AIR FLOW - MECHANICAL POWER (8 poles)

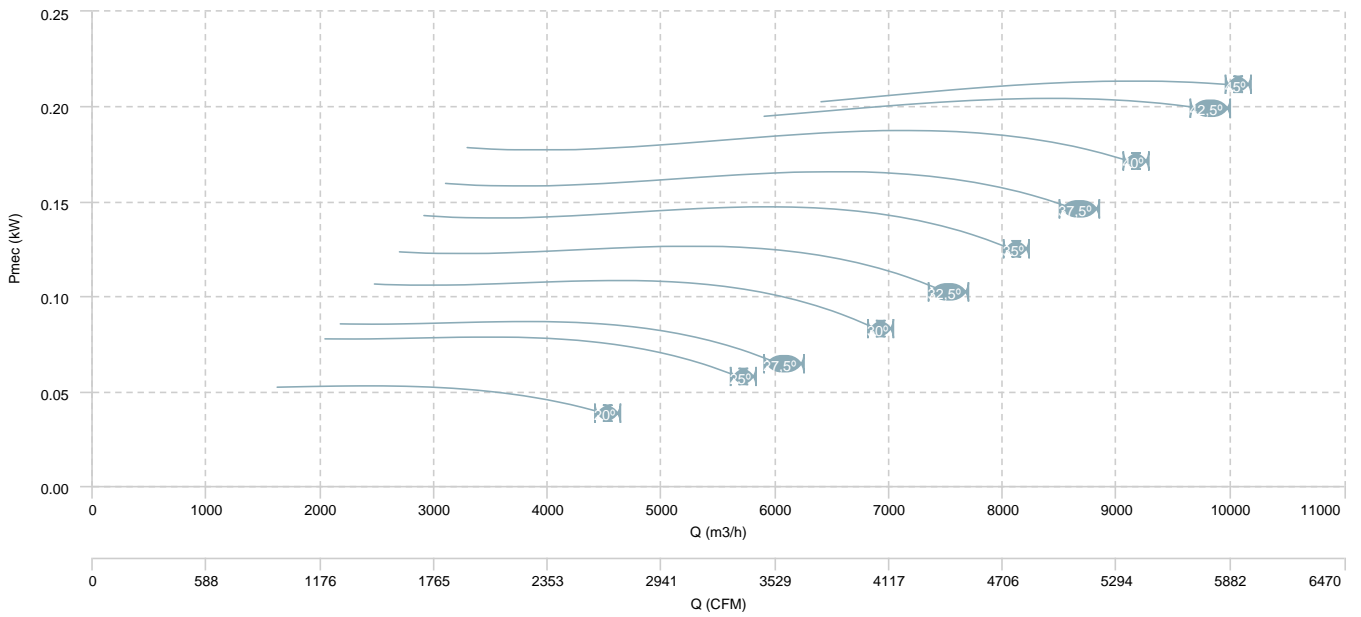

HC 63 T4/T8 (A2:9)

AIR FLOW - PRESSURE (4 poles)

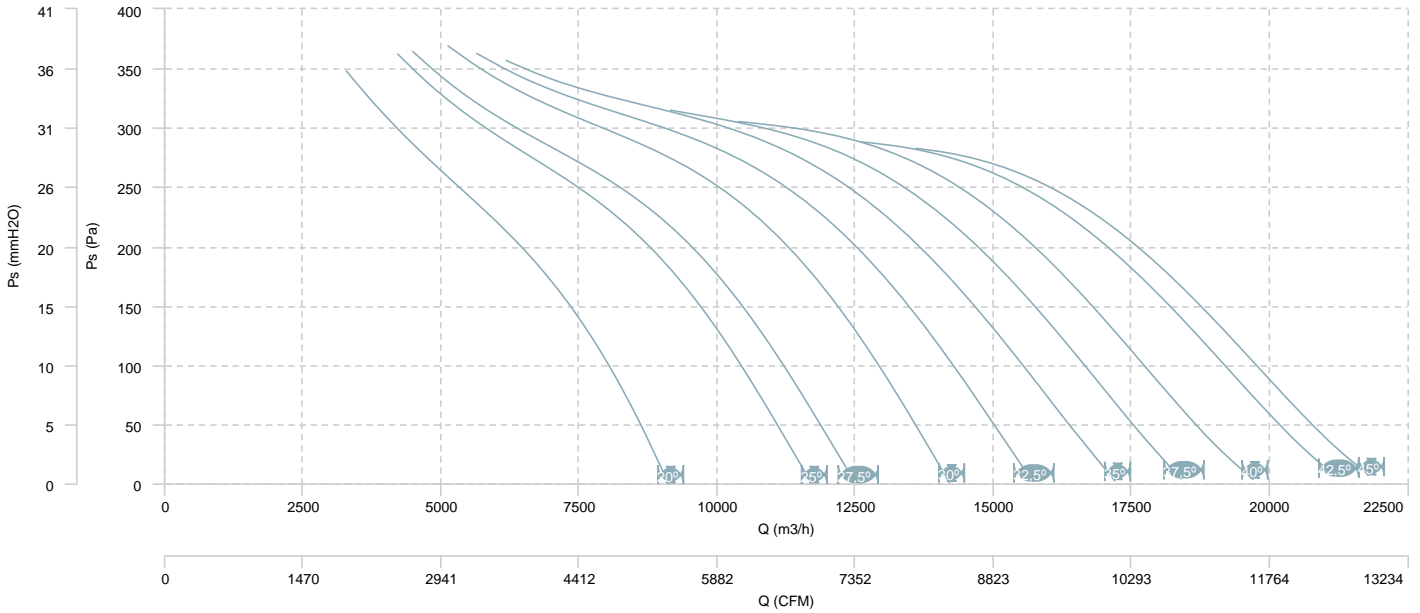

AIR FLOW - MECHANICAL POWER (4 poles)

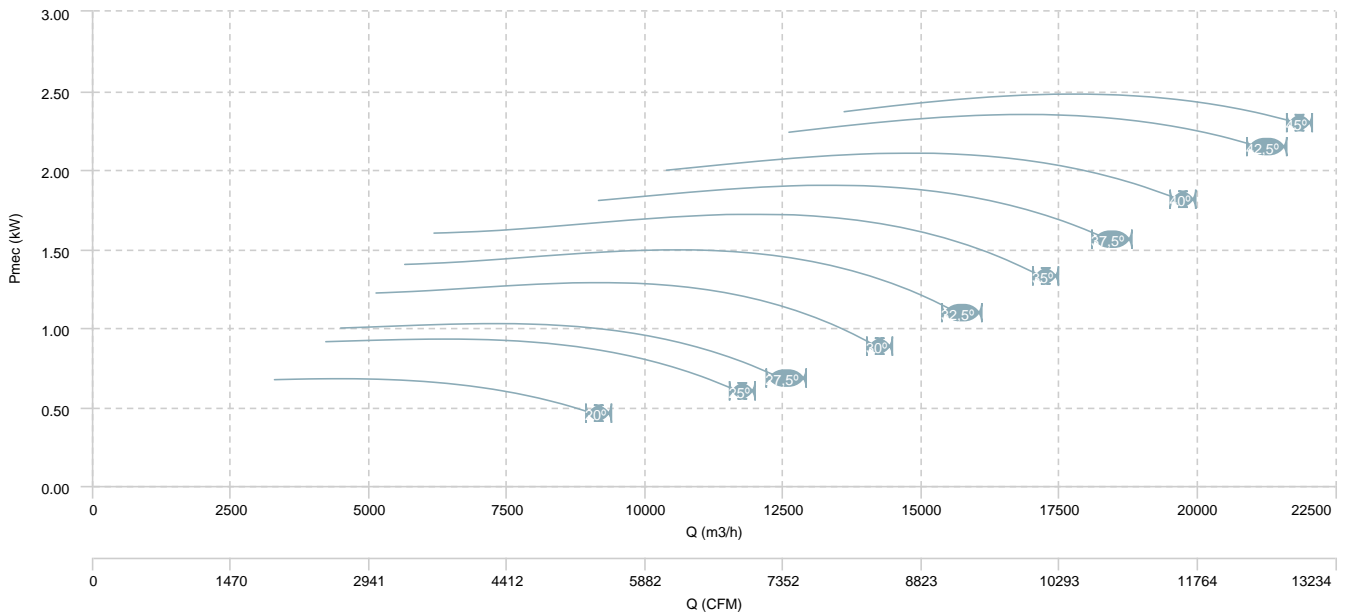

HC 63 T4/T8 (A2:9)

AIR FLOW - PRESSURE (8 poles)

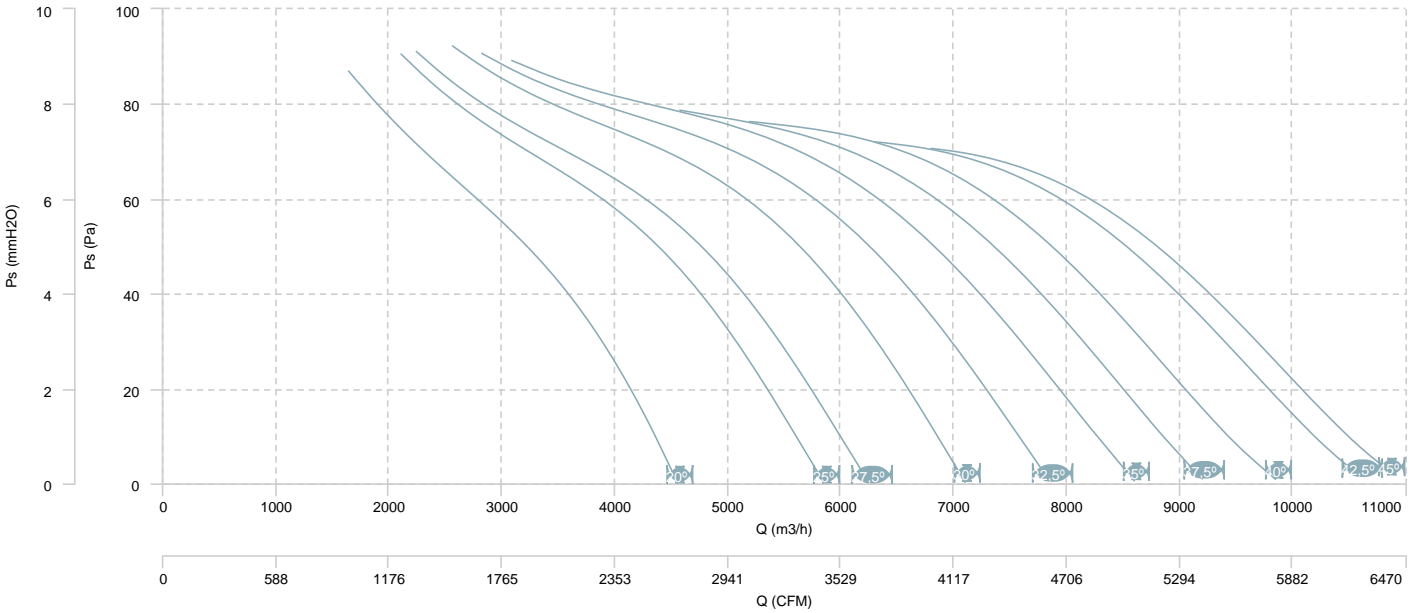

AIR FLOW - MECHANICAL POWER (8 poles)

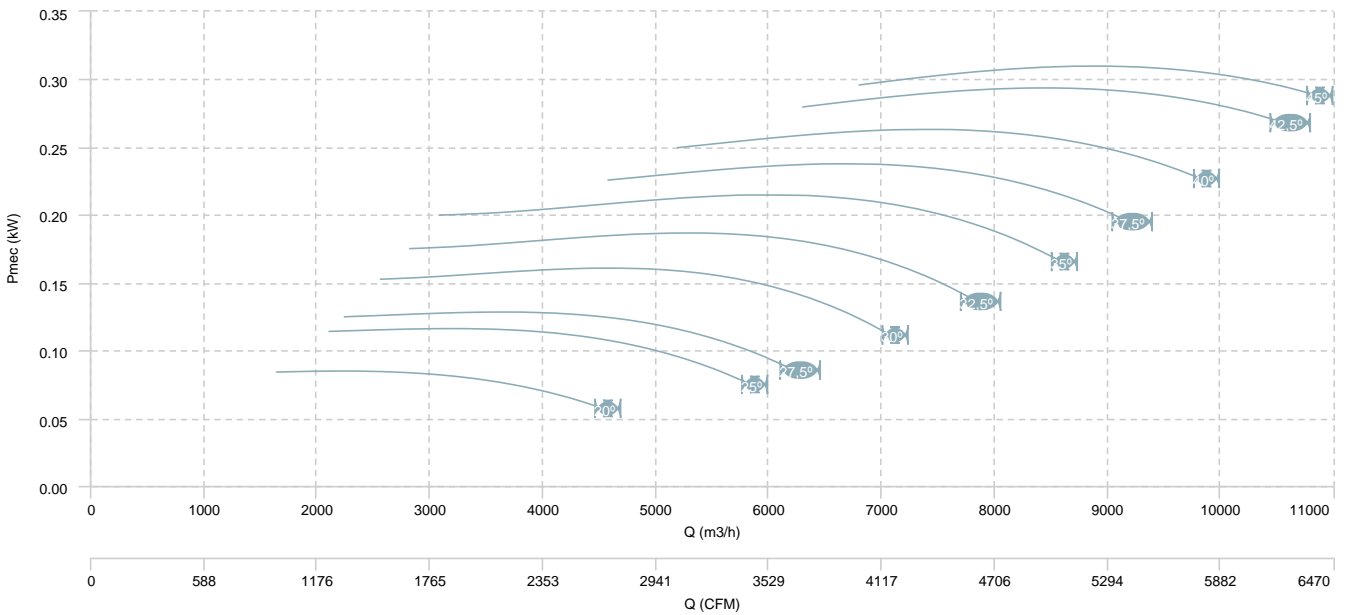

HC 63 T4/T8 (A5:6)

AIR FLOW - PRESSURE (4 poles)

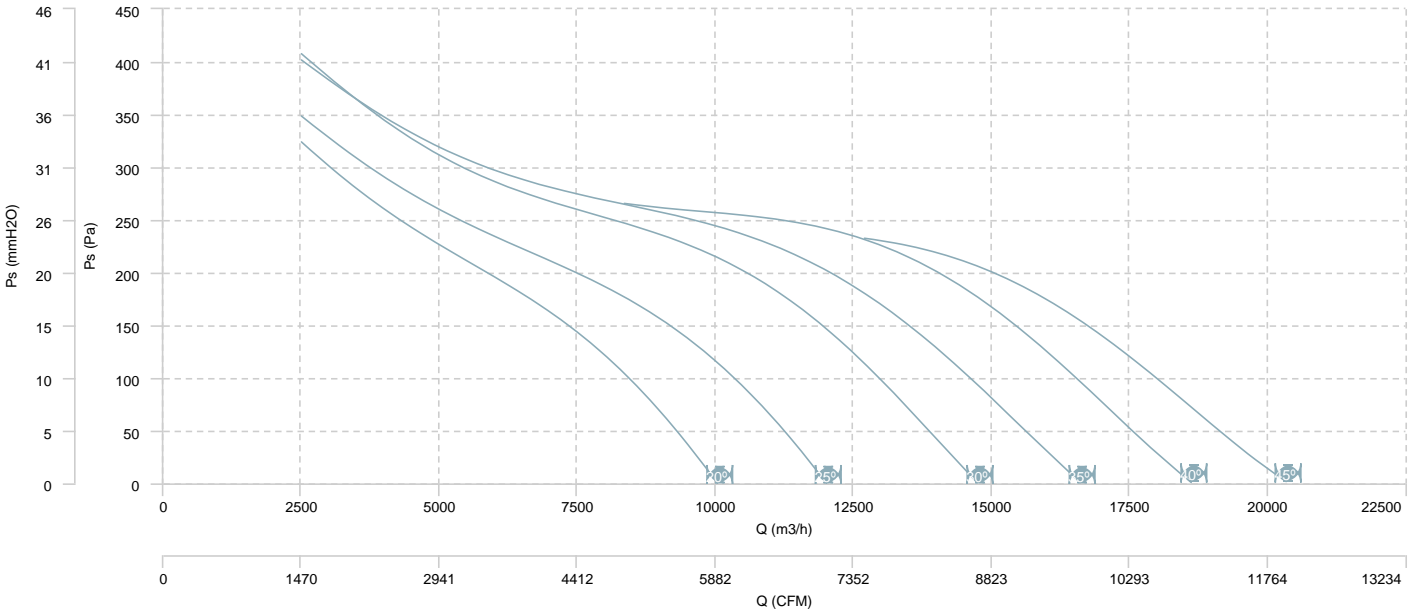

AIR FLOW - MECHANICAL POWER (4 poles)

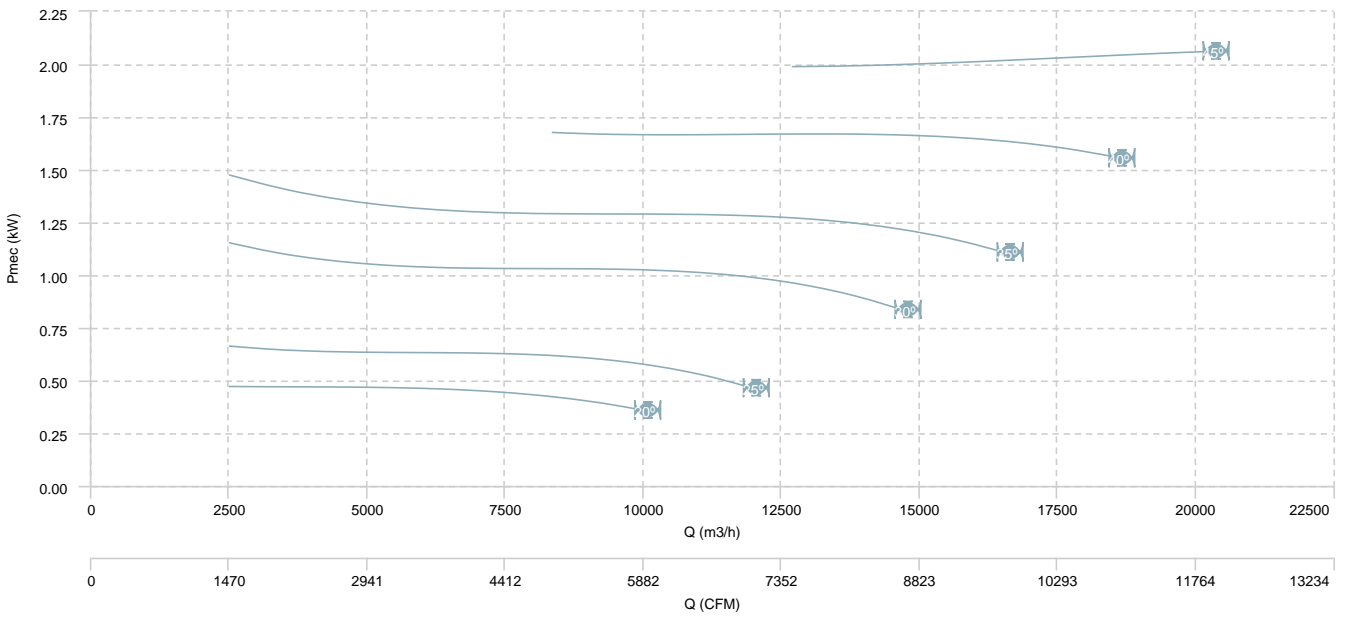

HC 63 T4/T8 (A5:6)

AIR FLOW - PRESSURE (8 poles)

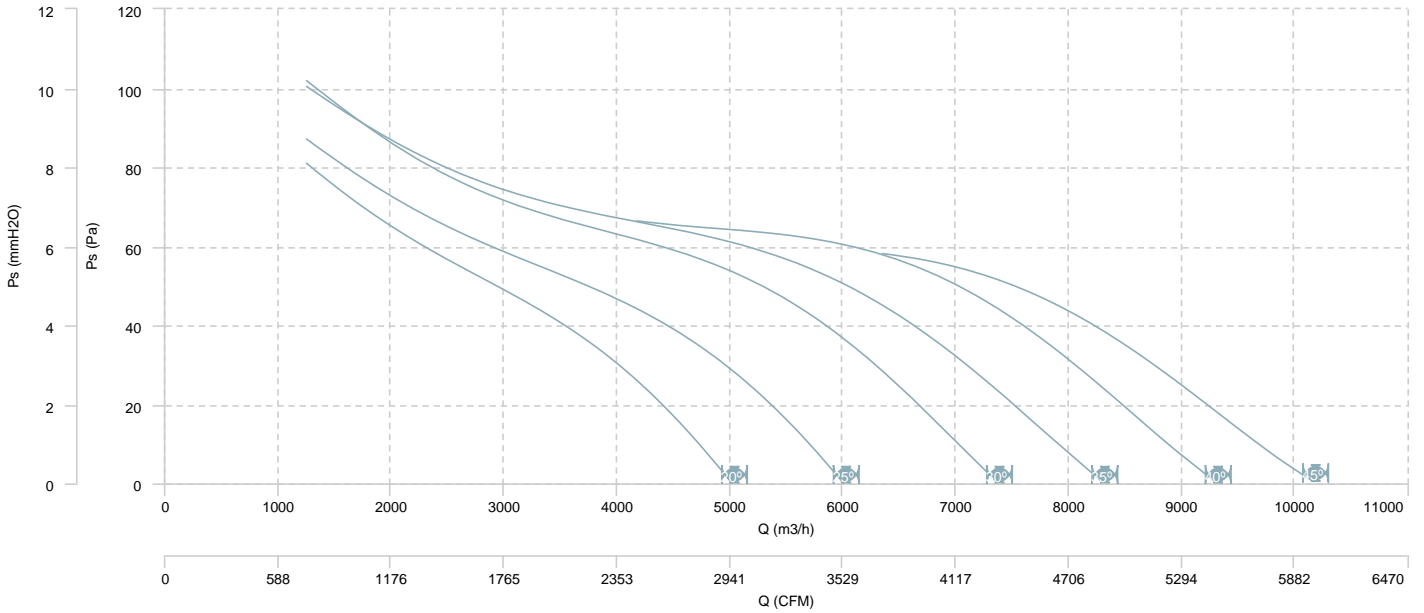

AIR FLOW - MECHANICAL POWER (8 poles)

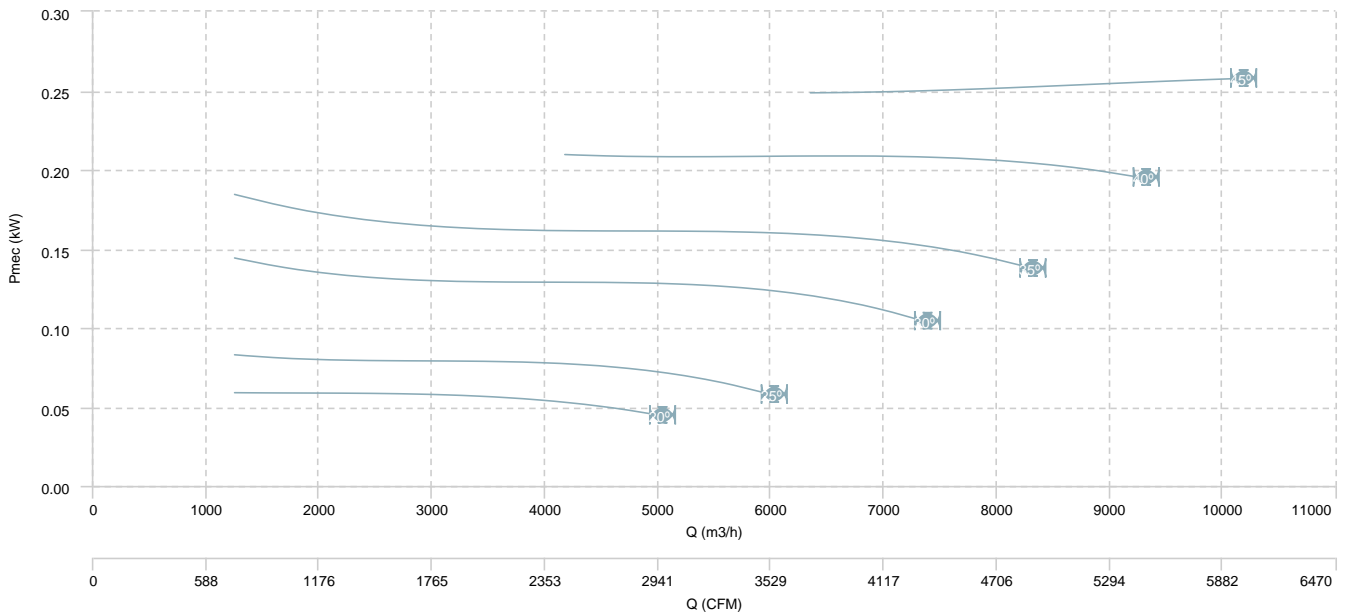

HC 71 T4 (A2:6)

AIR FLOW - PRESSURE

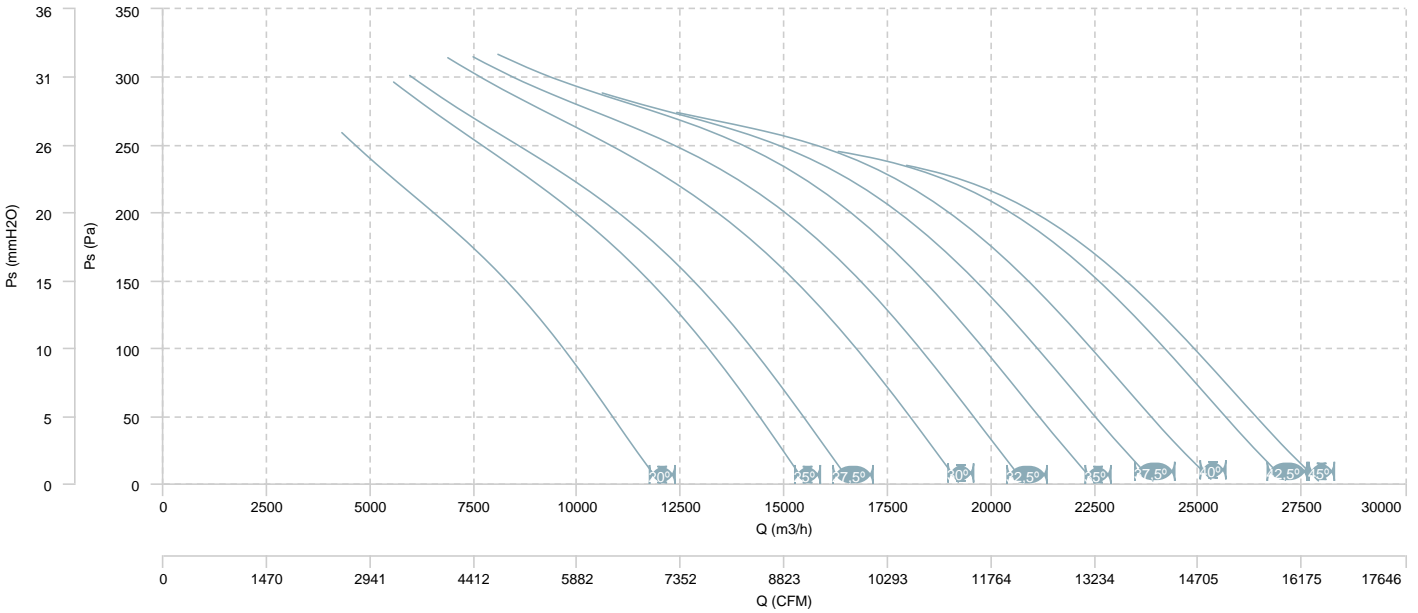

AIR FLOW - MECHANICAL POWER

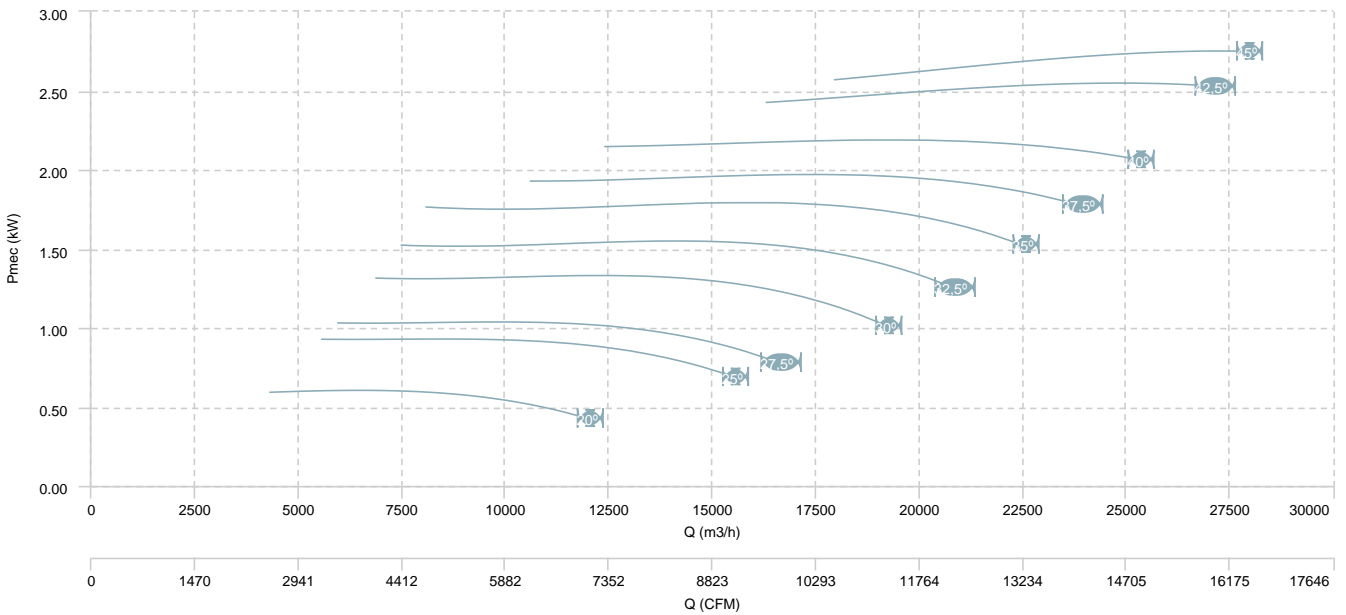

HC 71 T4 (A2:9)

AIR FLOW - PRESSURE

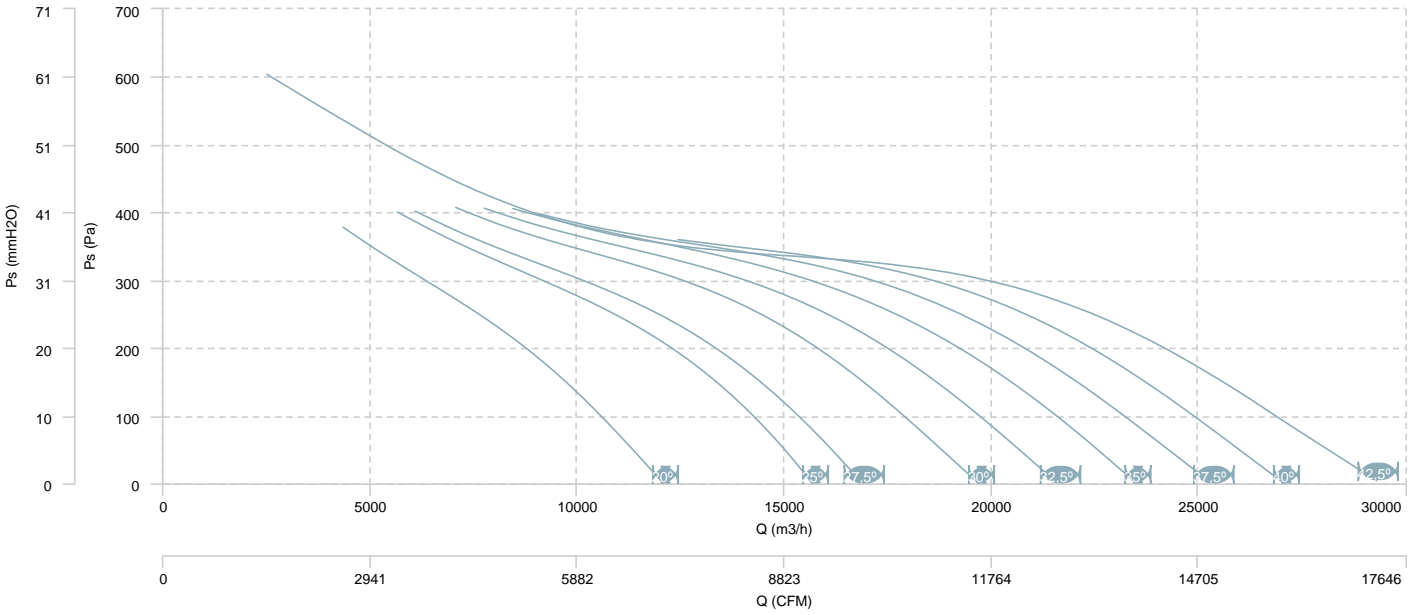

AIR FLOW - MECHANICAL POWER

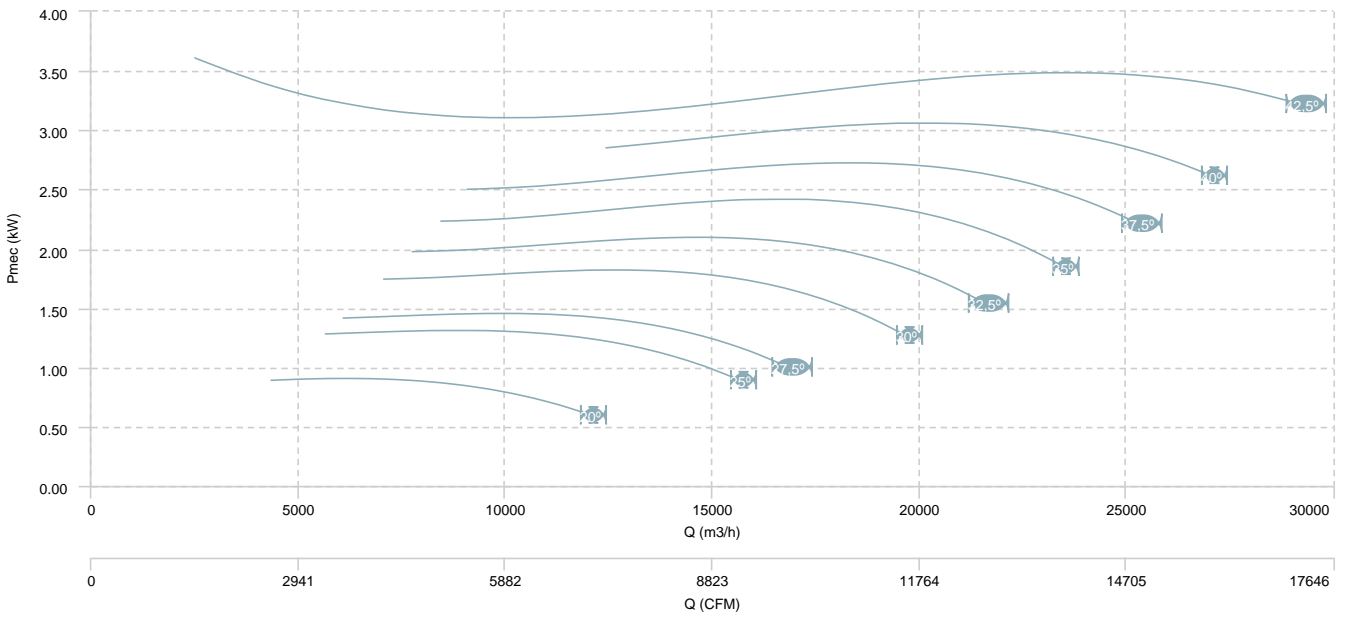

HC 71 T4 (A5:6)

AIR FLOW - PRESSURE

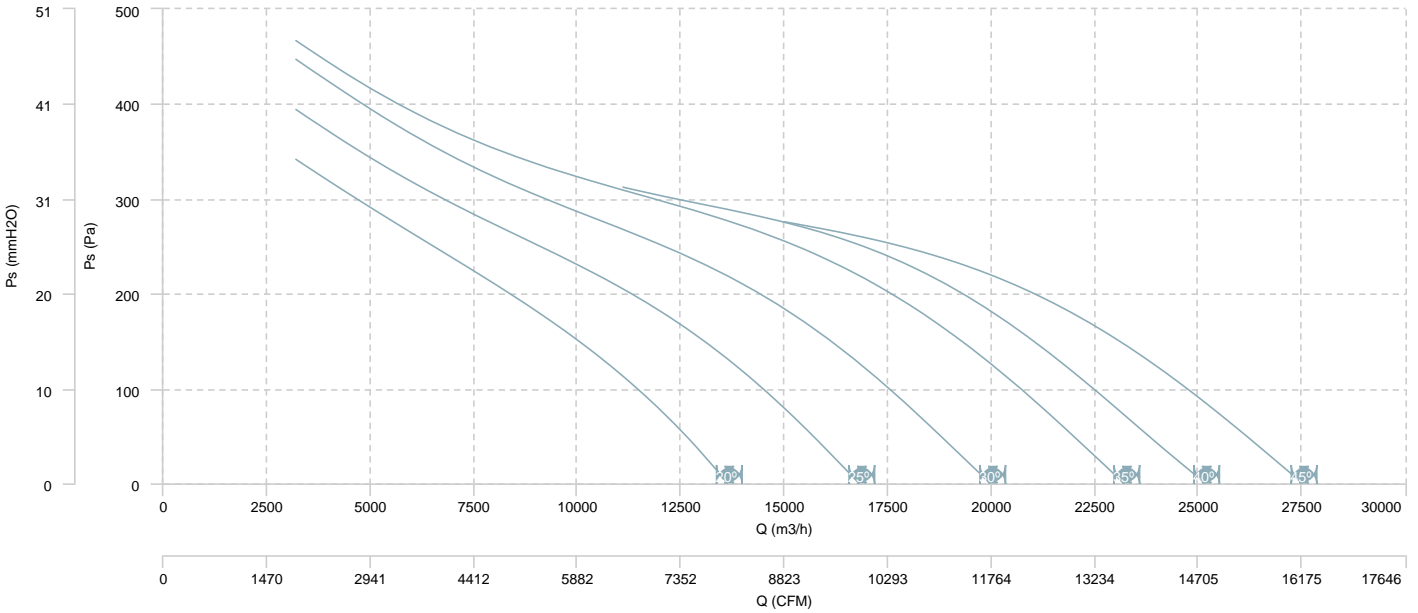

AIR FLOW - MECHANICAL POWER

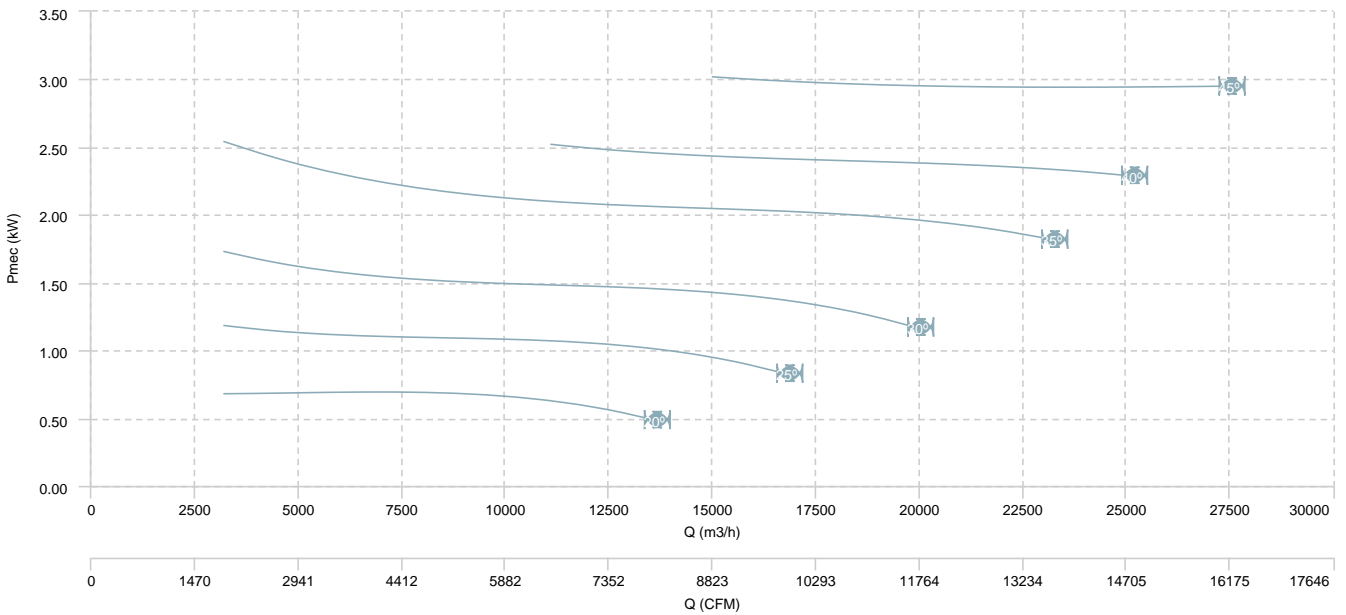

HC 71 T6 (A5:6)

AIR FLOW - PRESSURE

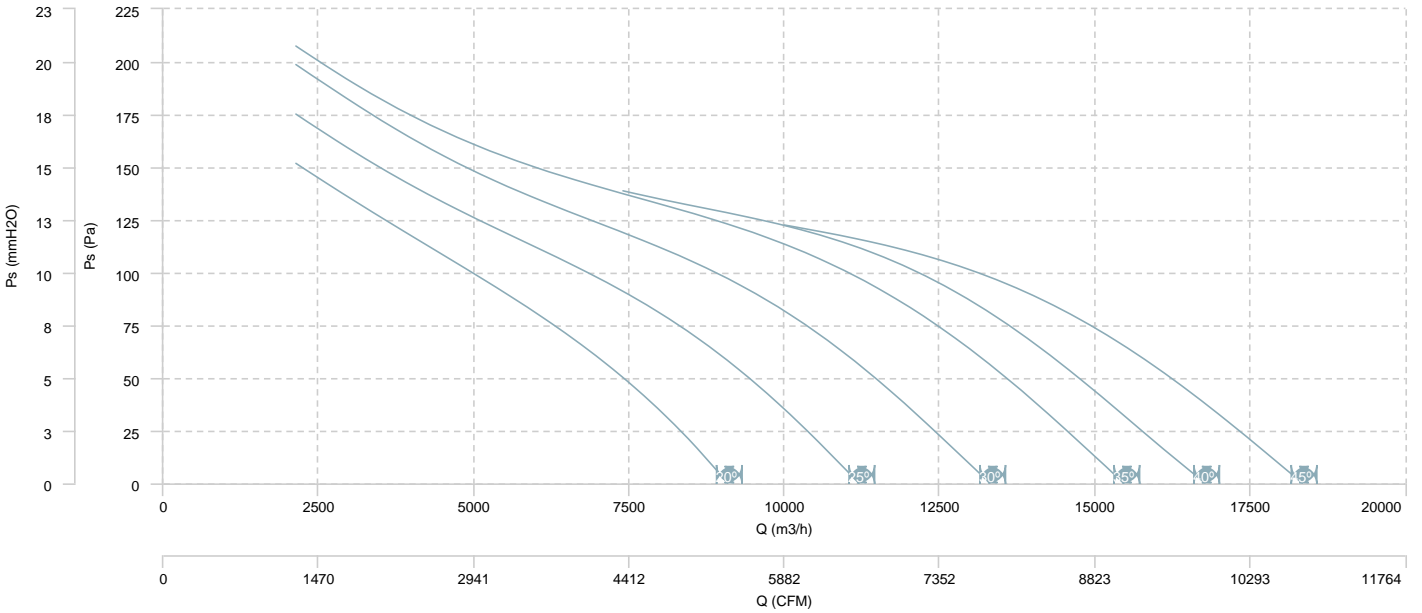

AIR FLOW - MECHANICAL POWER

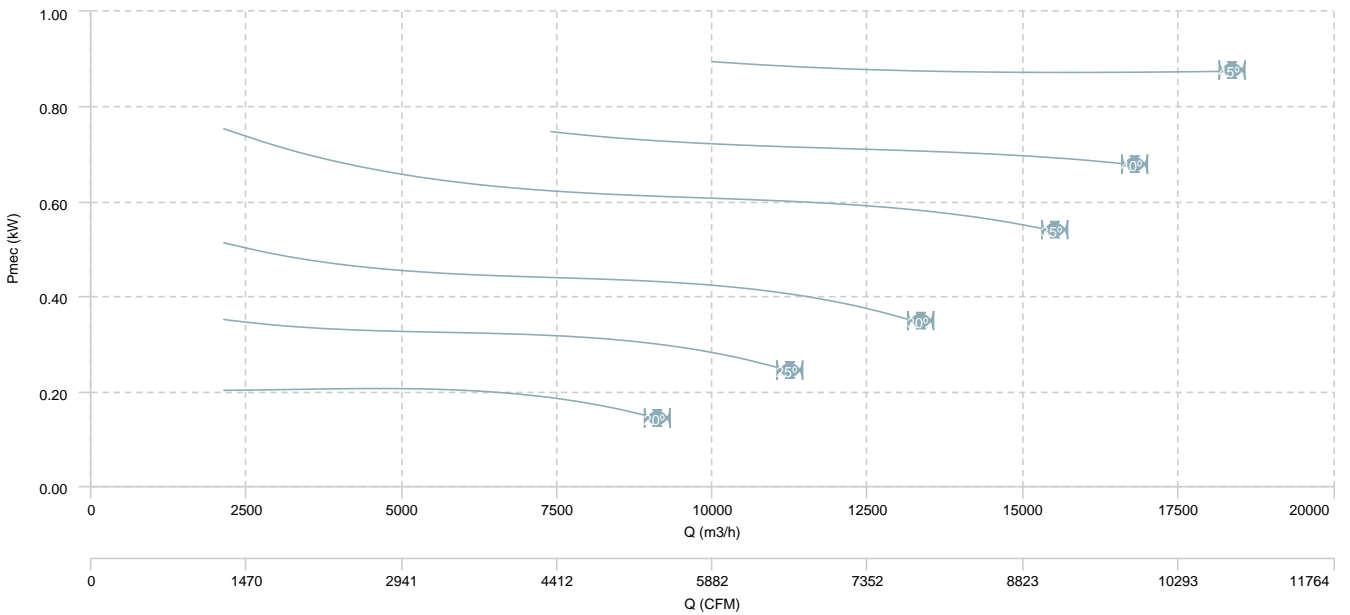

HC 71 T6 (A2:6)

AIR FLOW - PRESSURE

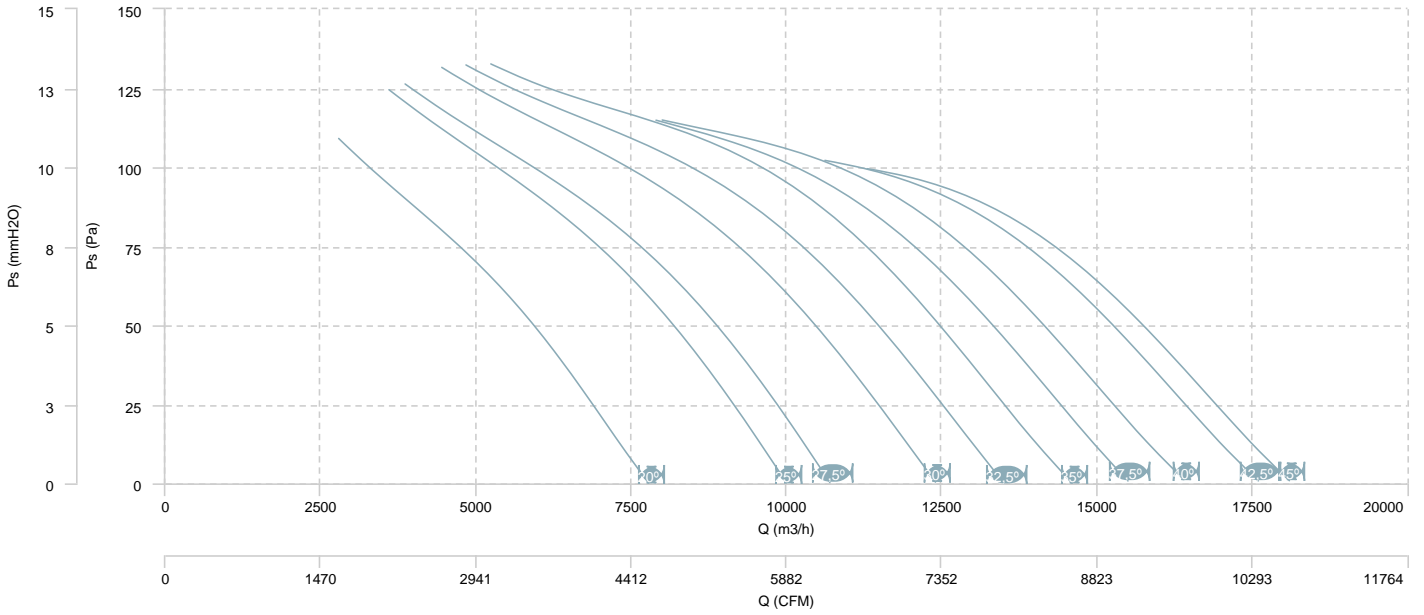

AIR FLOW - MECHANICAL POWER

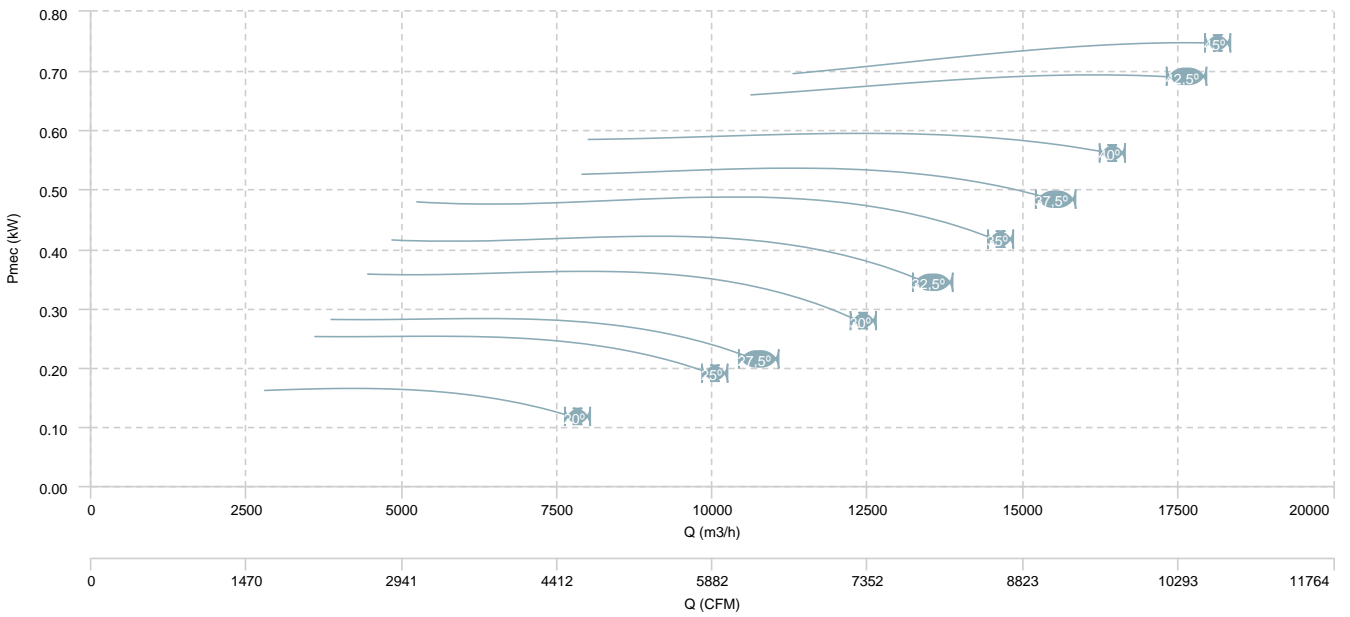

HC 71 T6 (A2:9)

AIR FLOW - PRESSURE

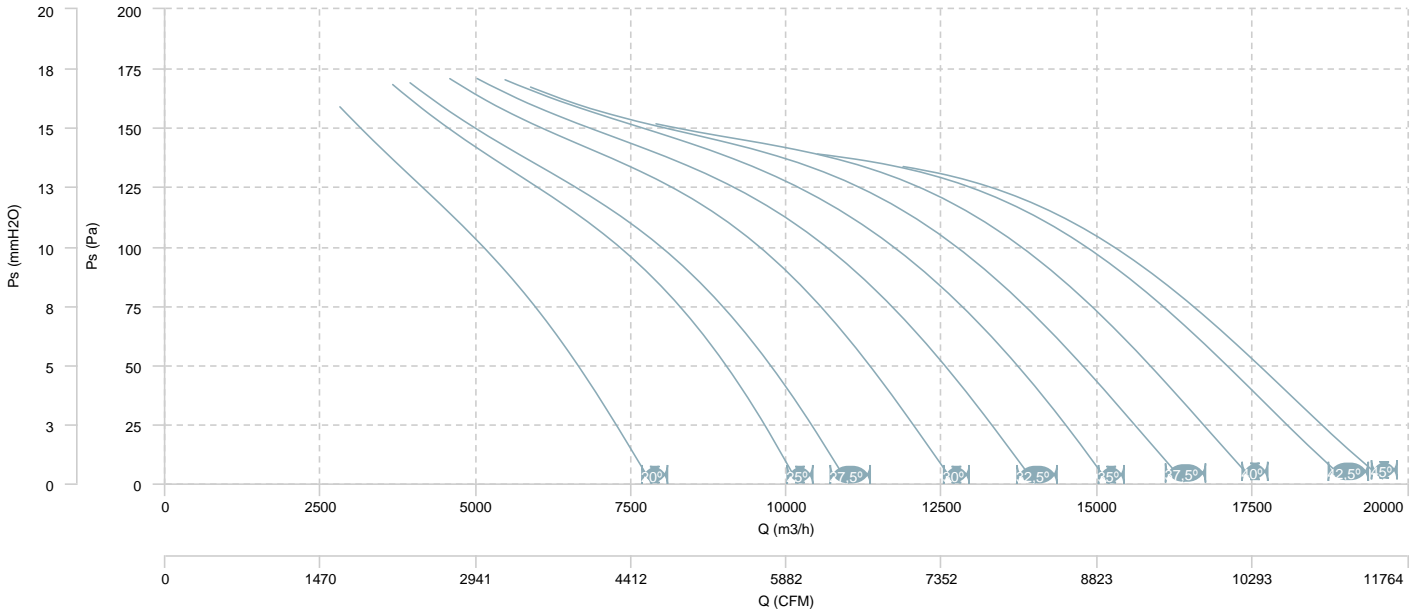

AIR FLOW - MECHANICAL POWER

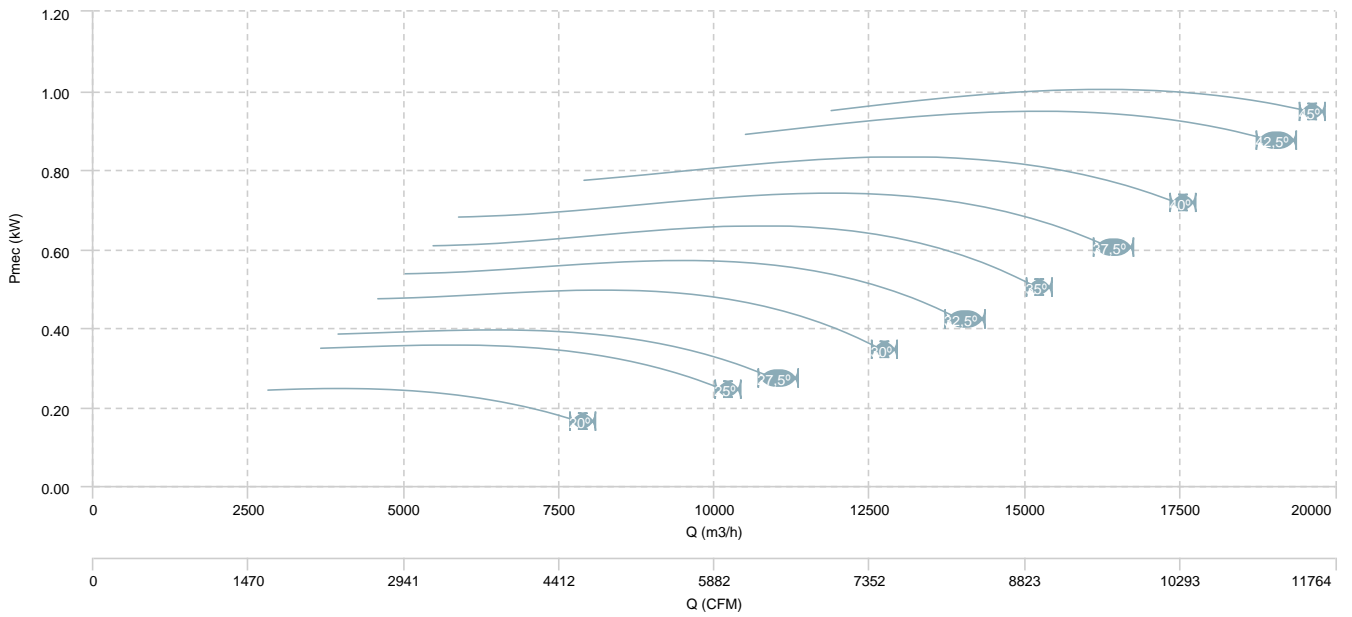

HC 71 T4/T8 (A2:6)

AIR FLOW - PRESSURE (4 poles)

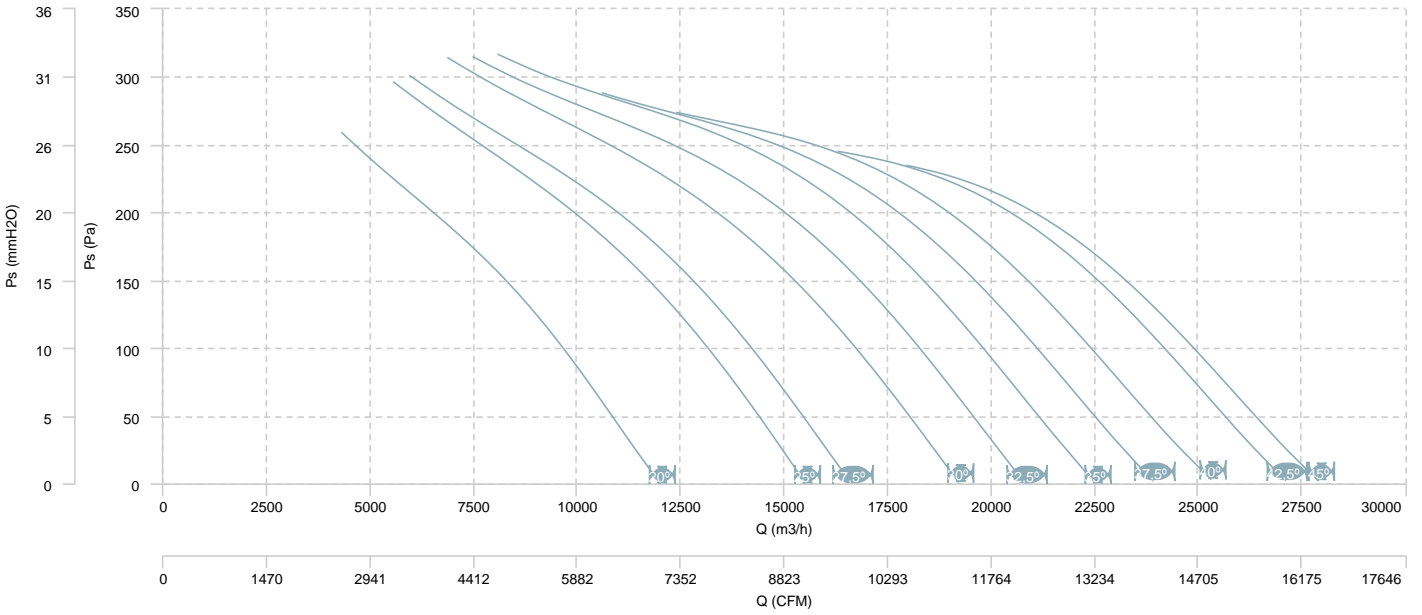

AIR FLOW - MECHANICAL POWER (4 poles)

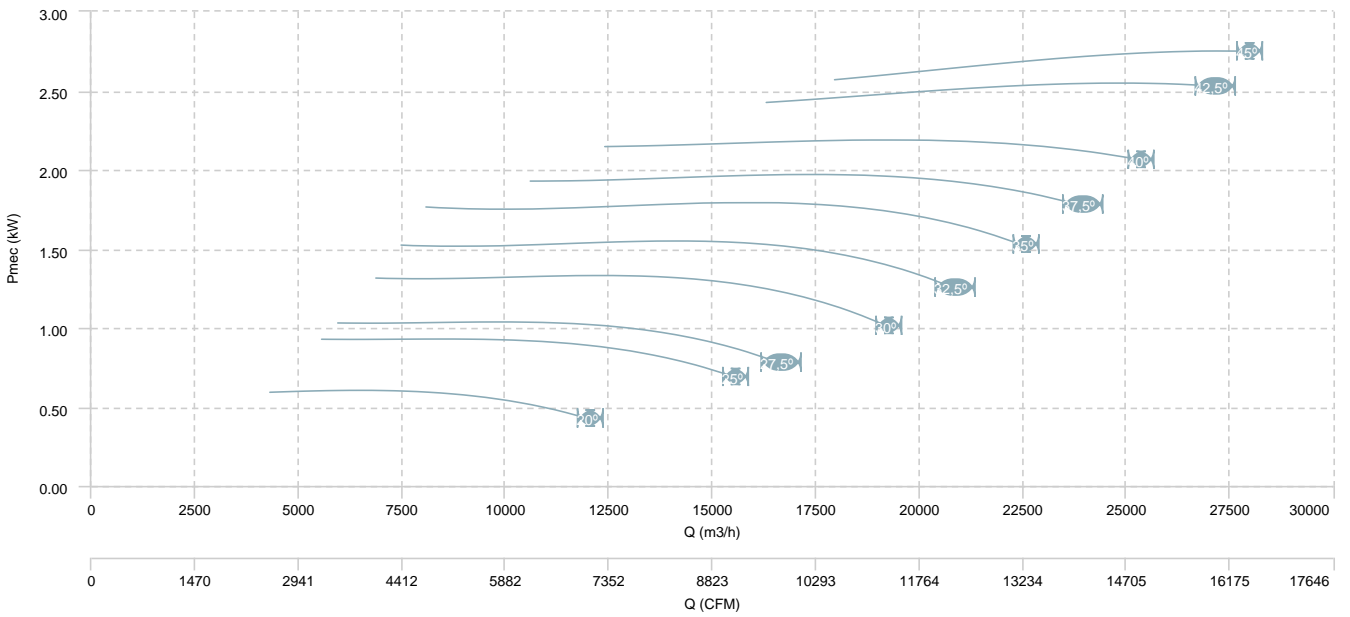

HC 71 T4/T8 (A2:6)

AIR FLOW - PRESSURE (8 poles)

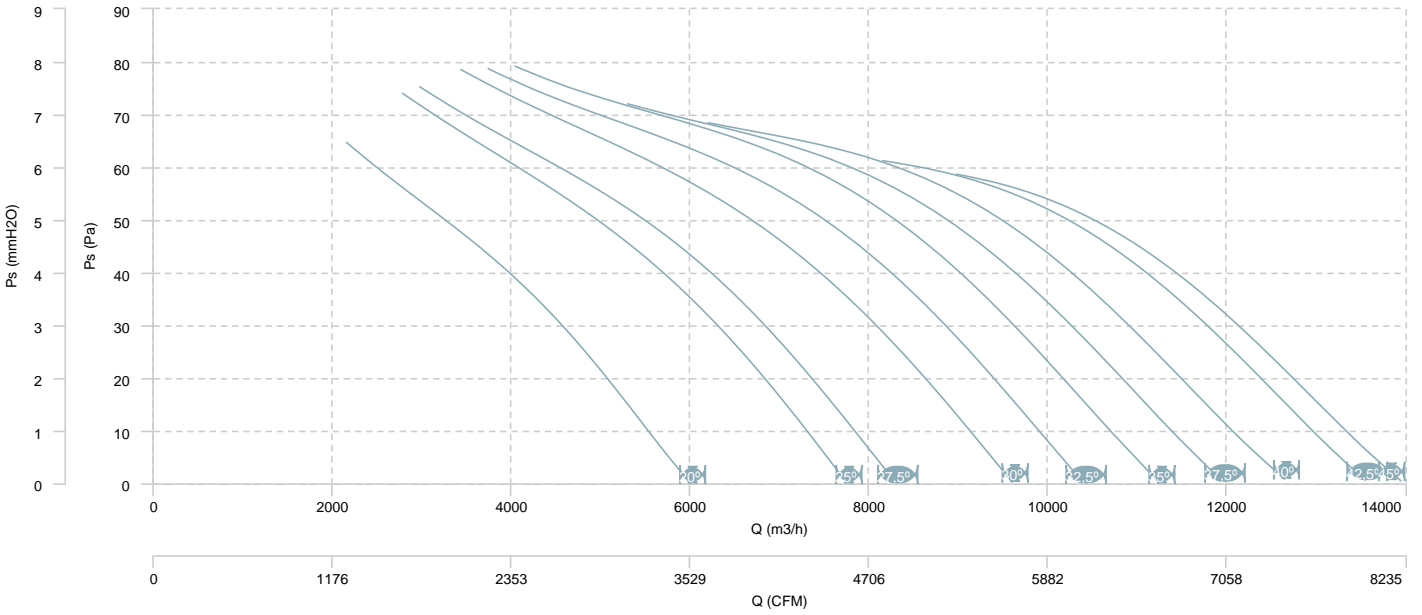

AIR FLOW - MECHANICAL POWER (8 poles)

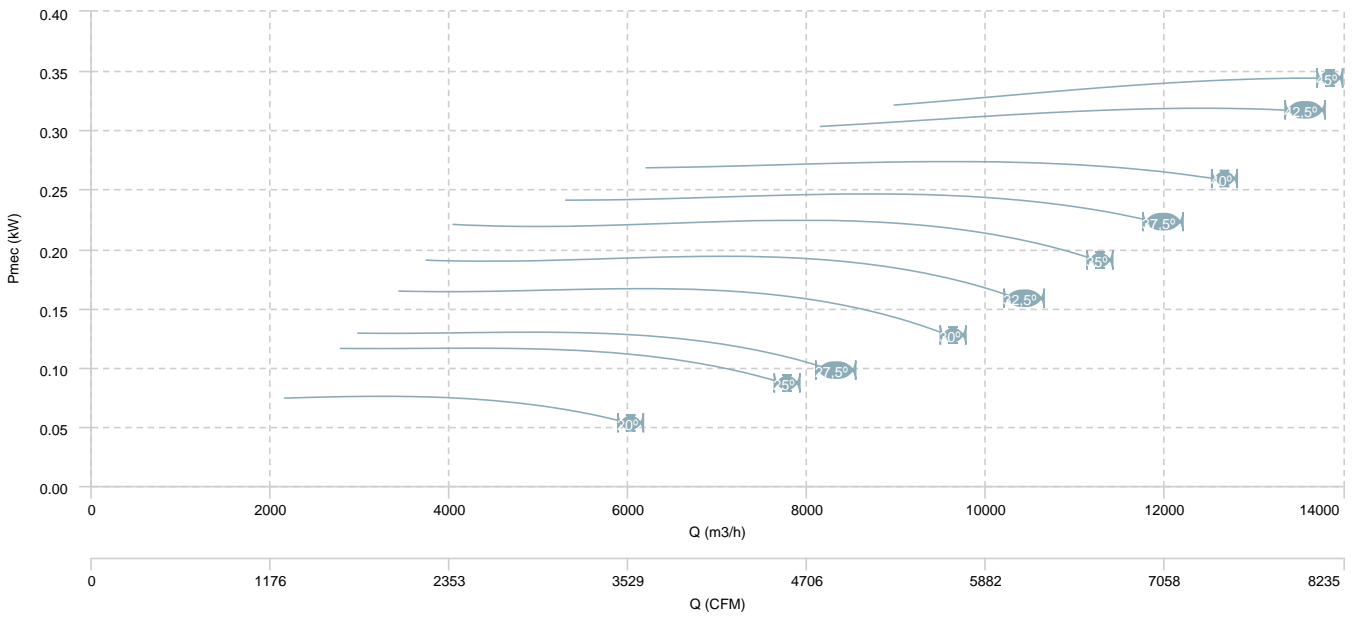

HC 71 T4/T8 (A2:9)

AIR FLOW - PRESSURE (4 poles)

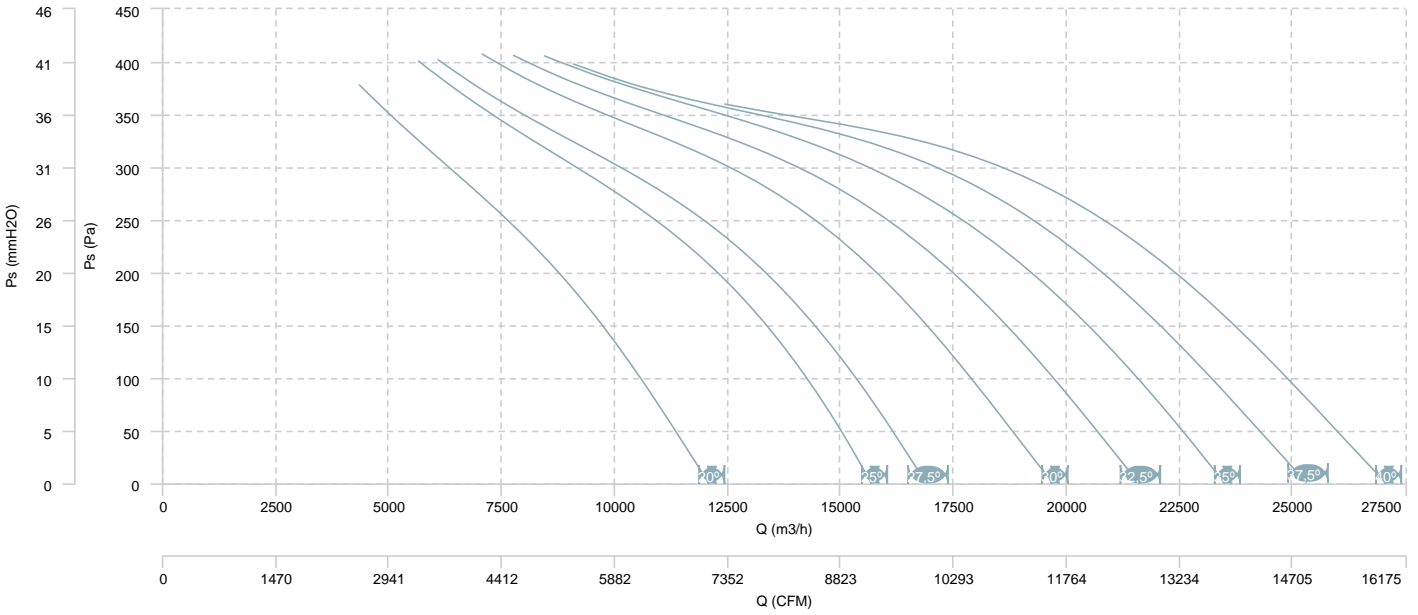

AIR FLOW - MECHANICAL POWER (4 poles)

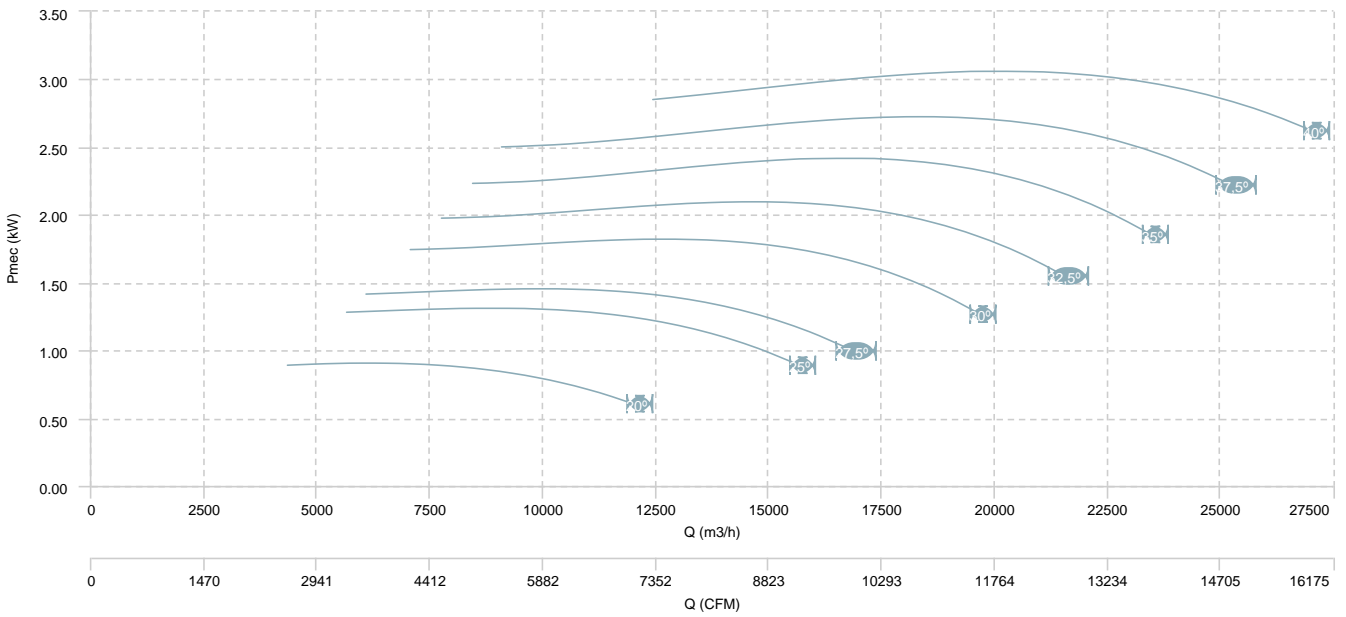

HC 71 T4/T8 (A2:9)

AIR FLOW - PRESSURE (8 poles)

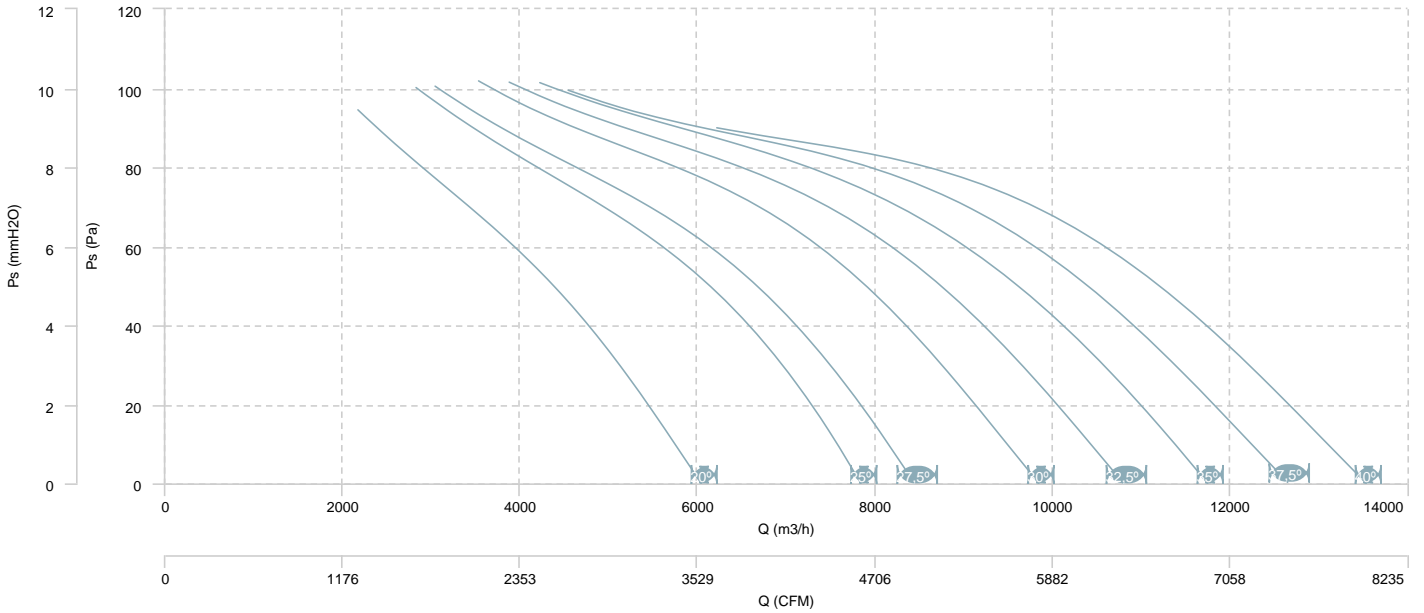

AIR FLOW - MECHANICAL POWER (8 poles)

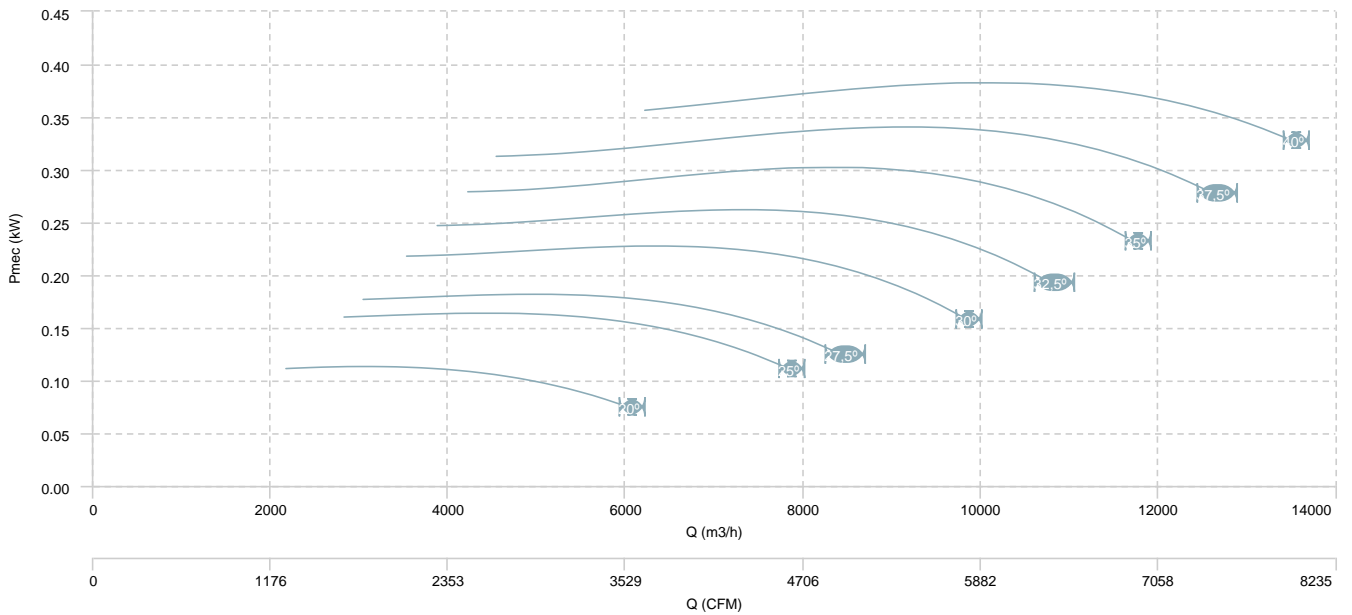

HC 71 T4/T8 (A5:6)

AIR FLOW - PRESSURE (4 poles)

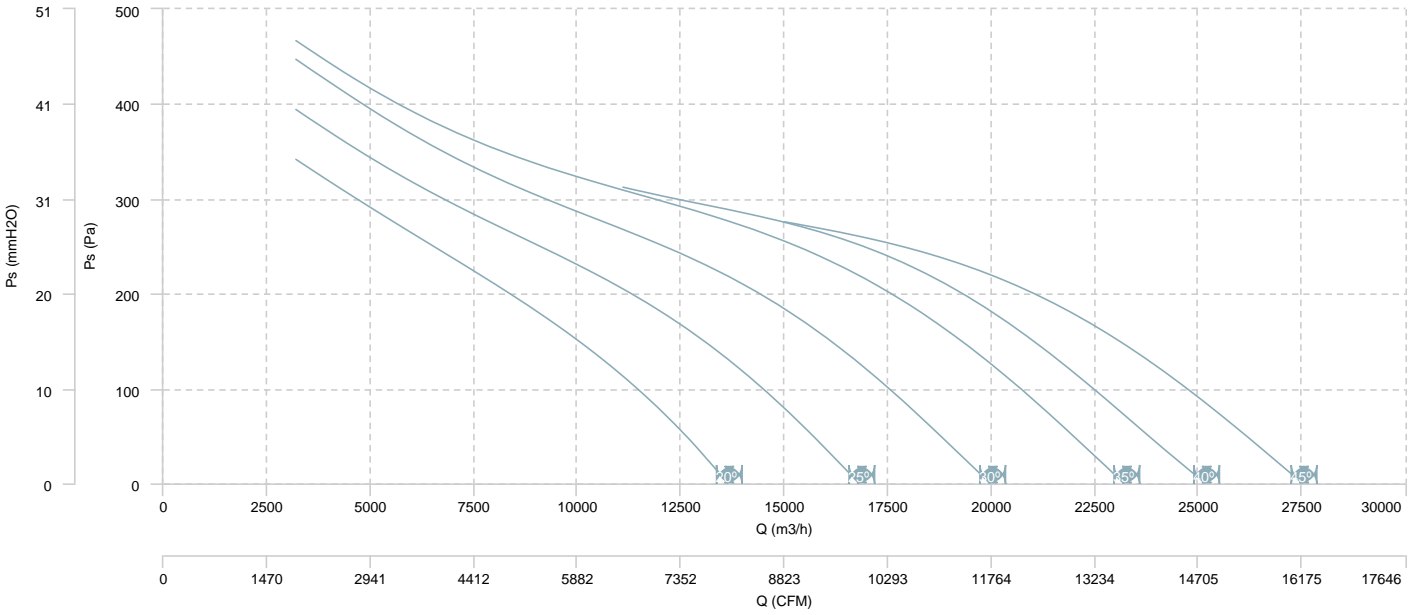

AIR FLOW - MECHANICAL POWER (4 poles)

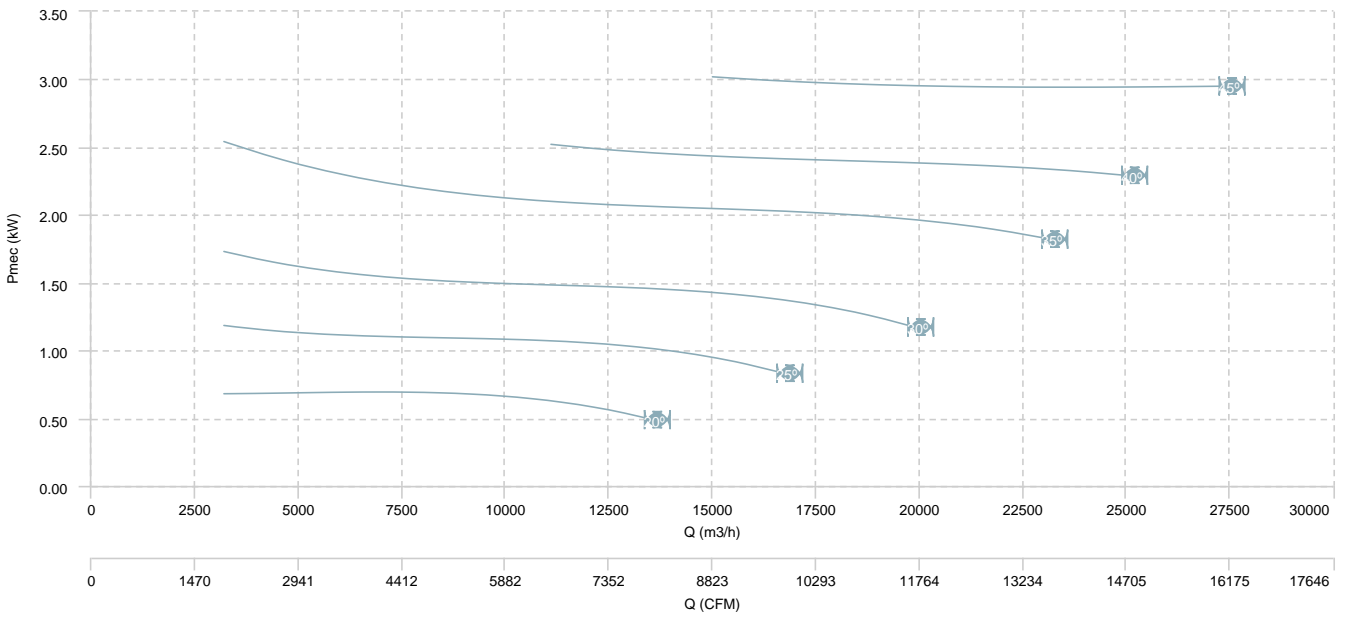

HC 71 T4/T8 (A5:6)

AIR FLOW - PRESSURE (8 poles)

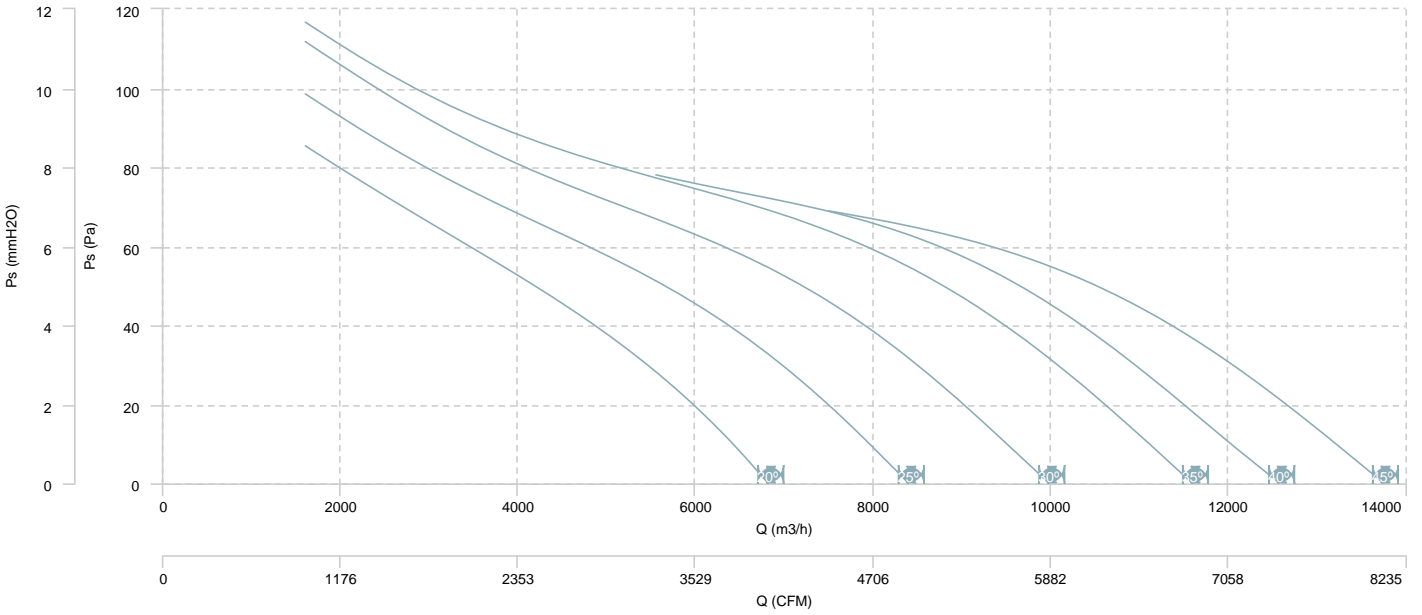

AIR FLOW - MECHANICAL POWER (8 poles)

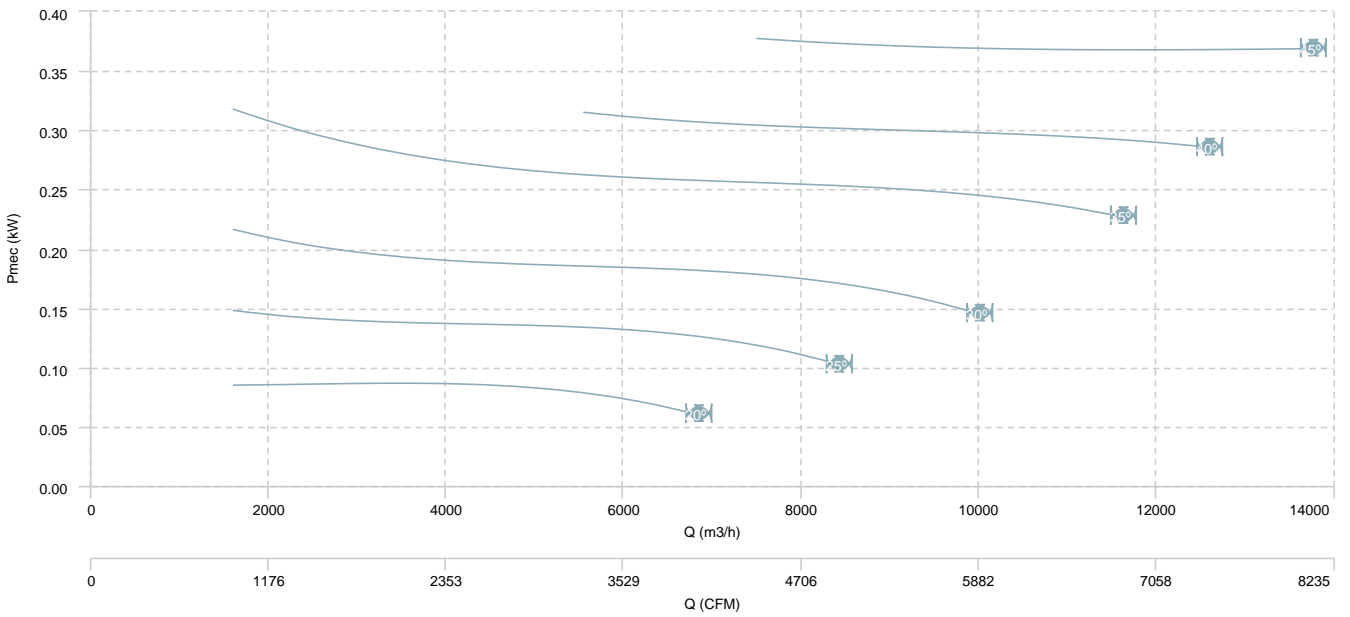

HC 80 T4 (A2:6)

AIR FLOW - PRESSURE

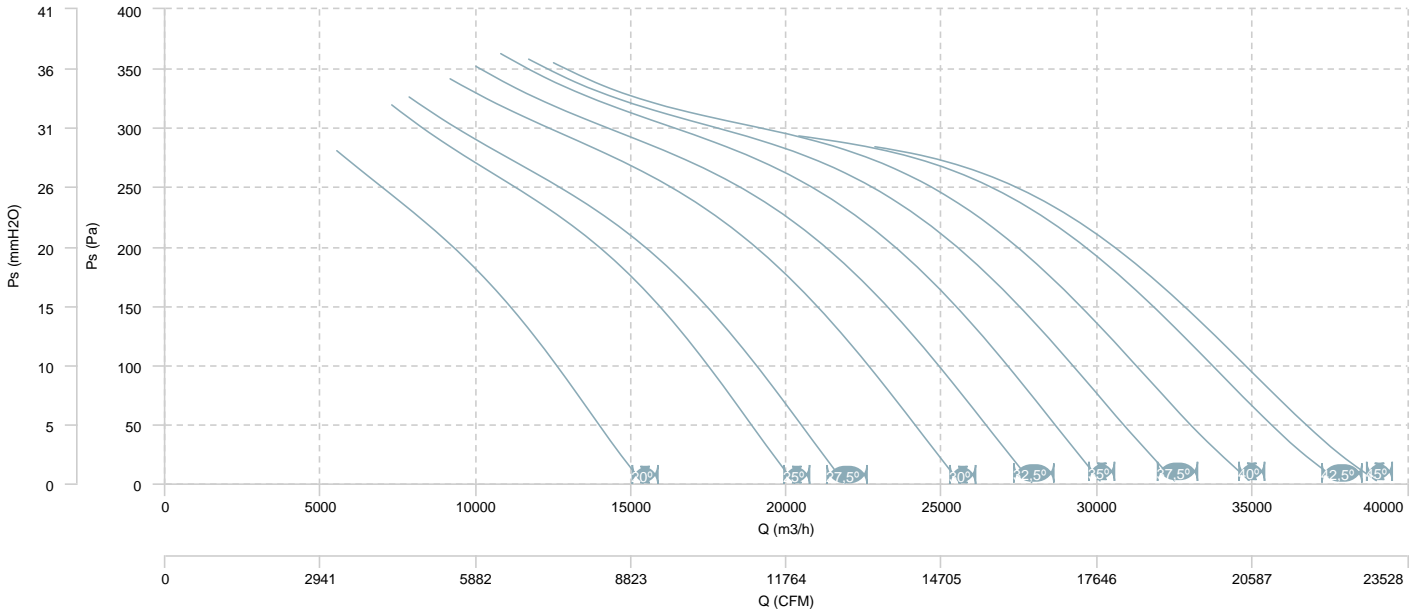

AIR FLOW - MECHANICAL POWER

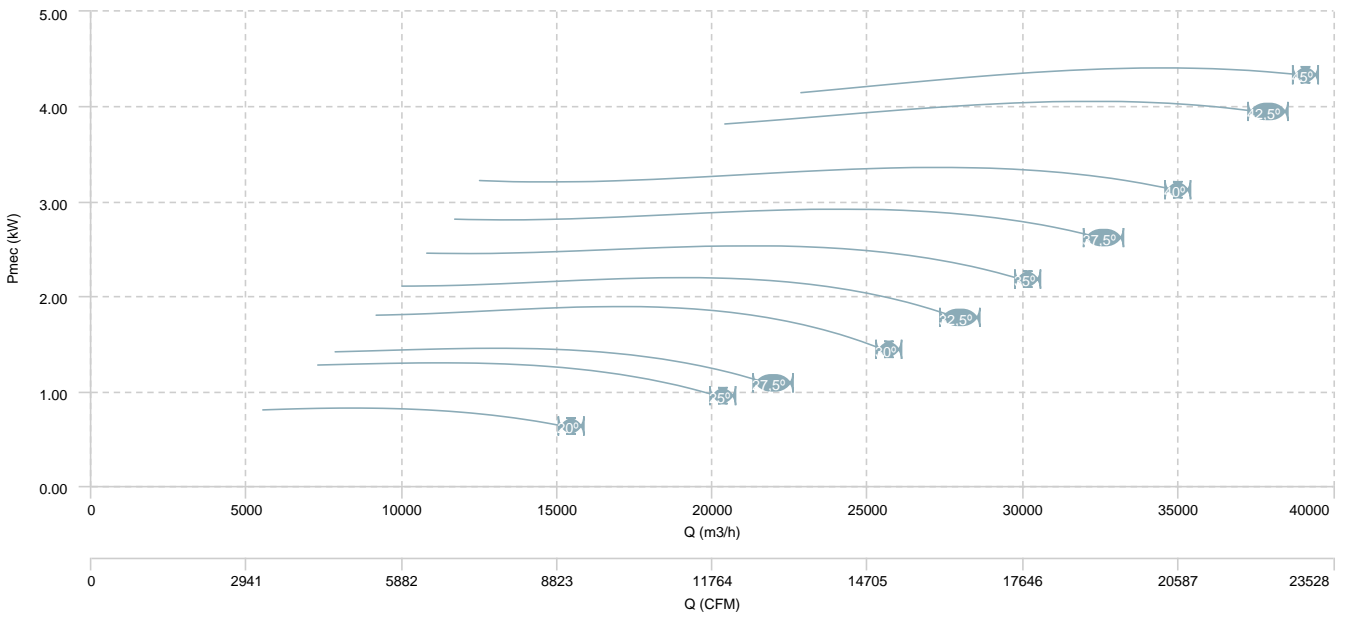

HC 80 T4 (A2:9)

AIR FLOW - PRESSURE

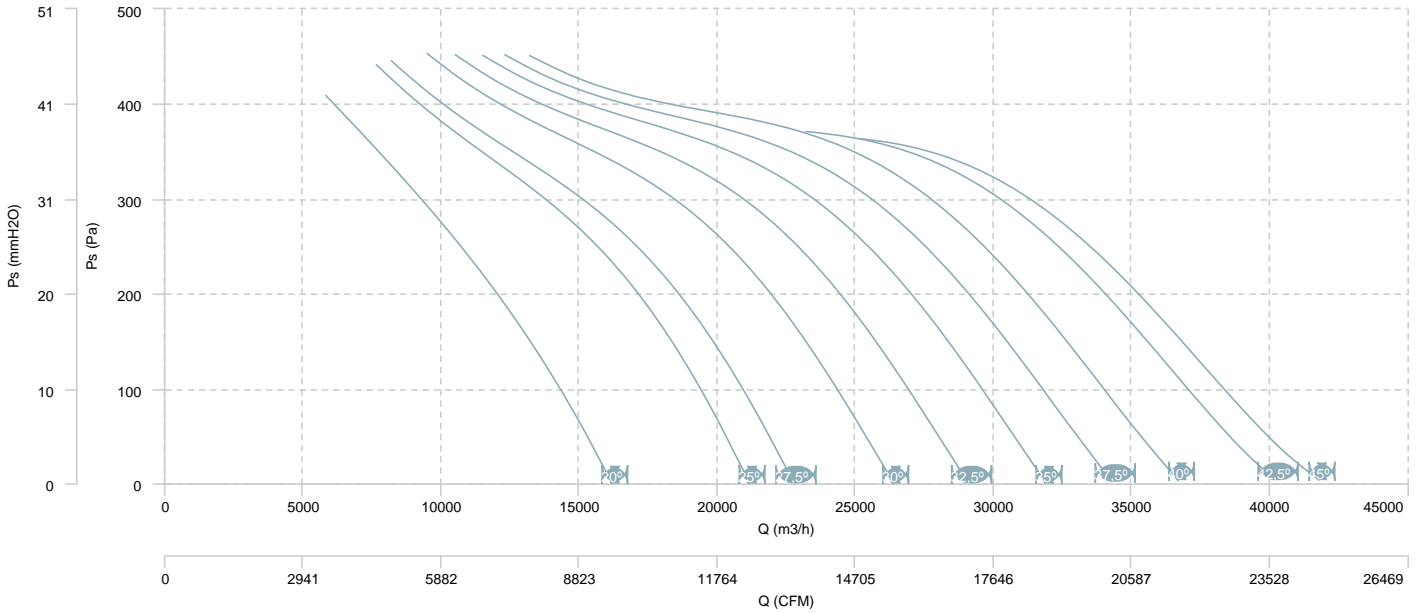

AIR FLOW - MECHANICAL POWER

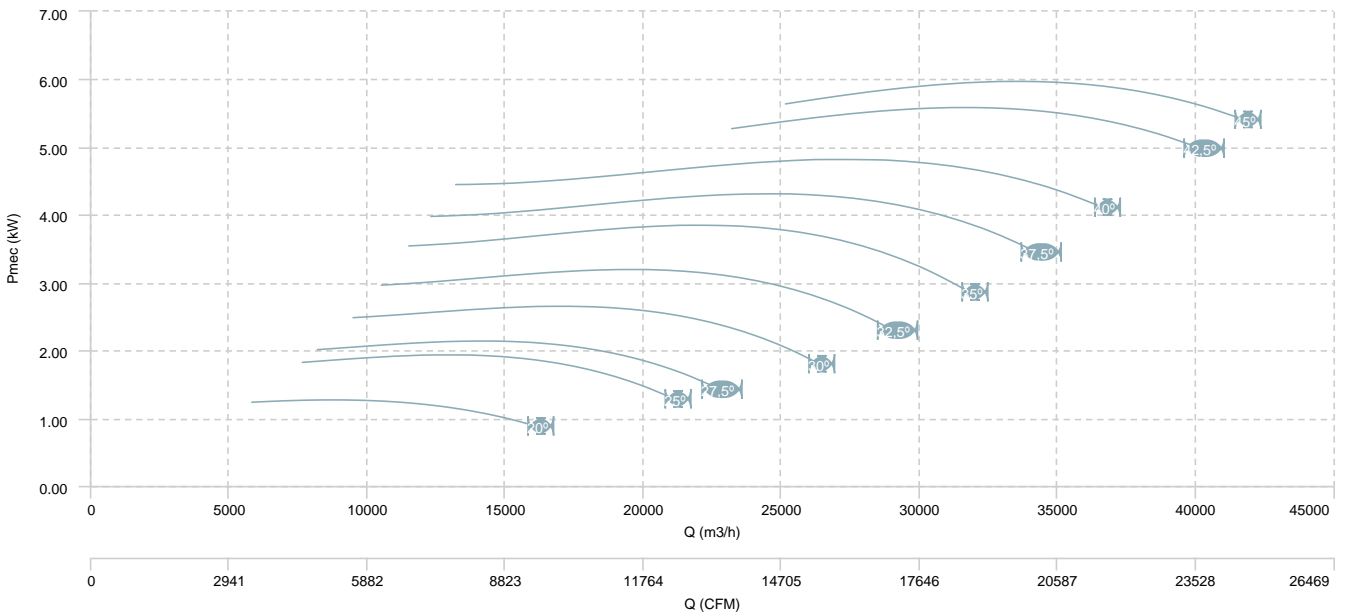

HC 80 T4 (A5:6)

AIR FLOW - PRESSURE

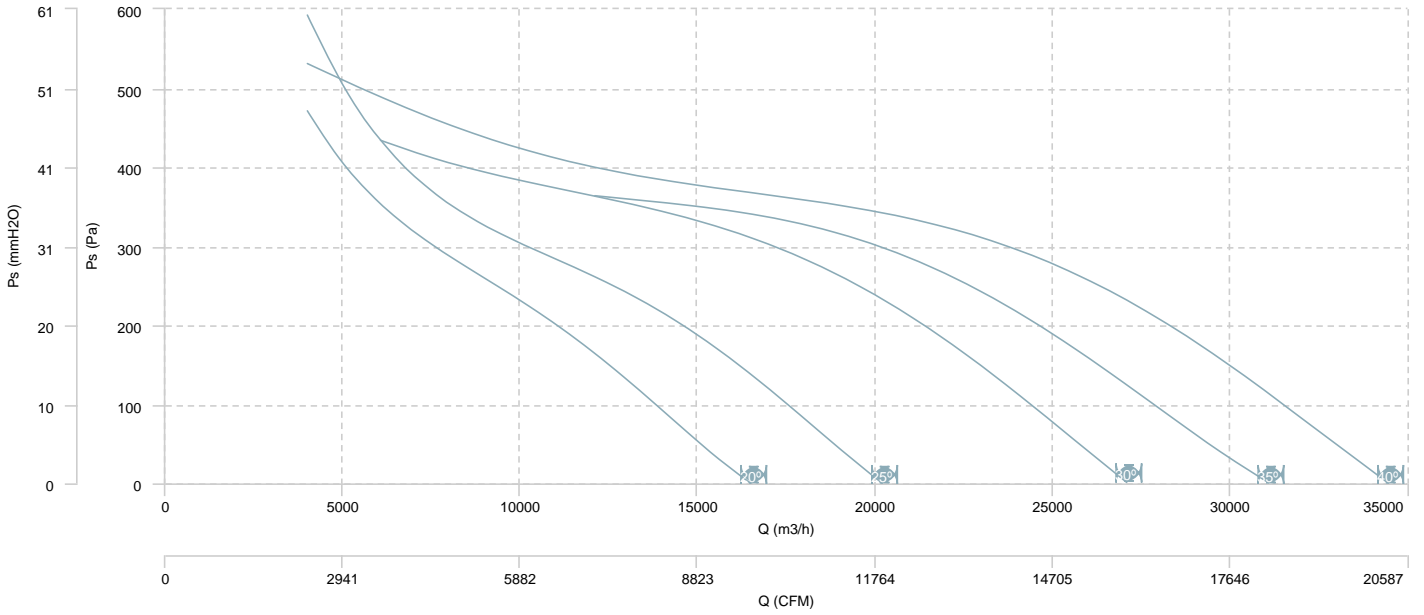

AIR FLOW - MECHANICAL POWER

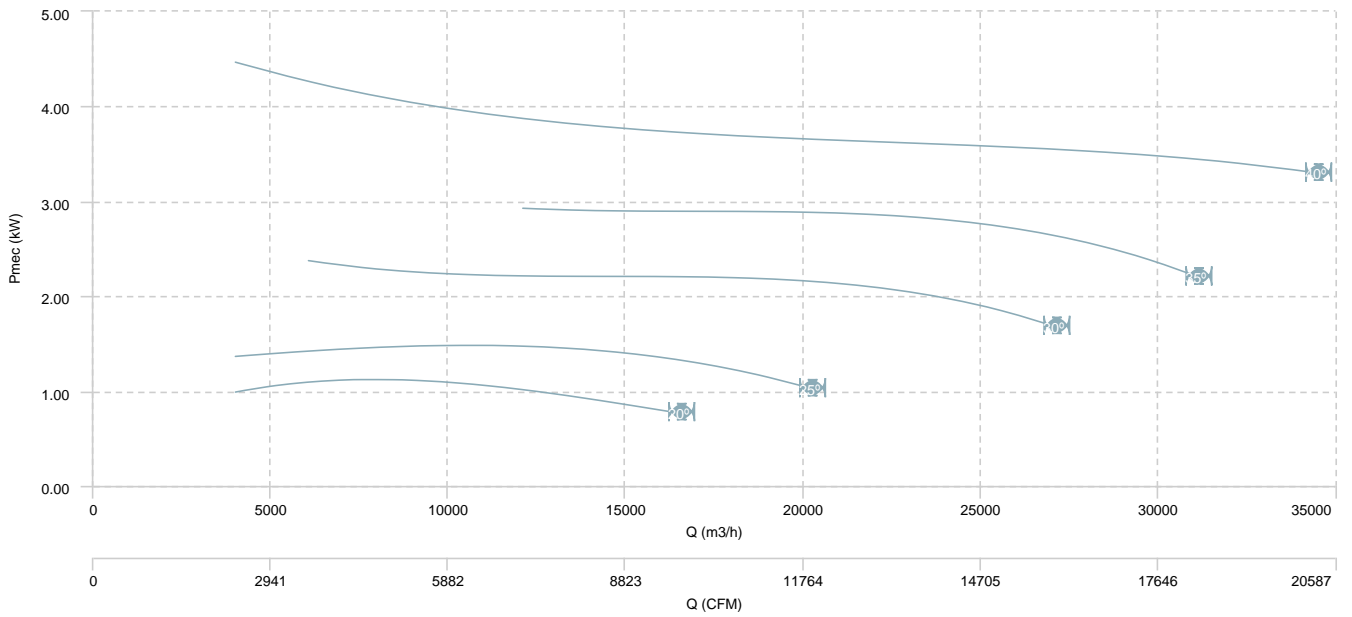

HC 80 T6 (A5:6)

AIR FLOW - PRESSURE

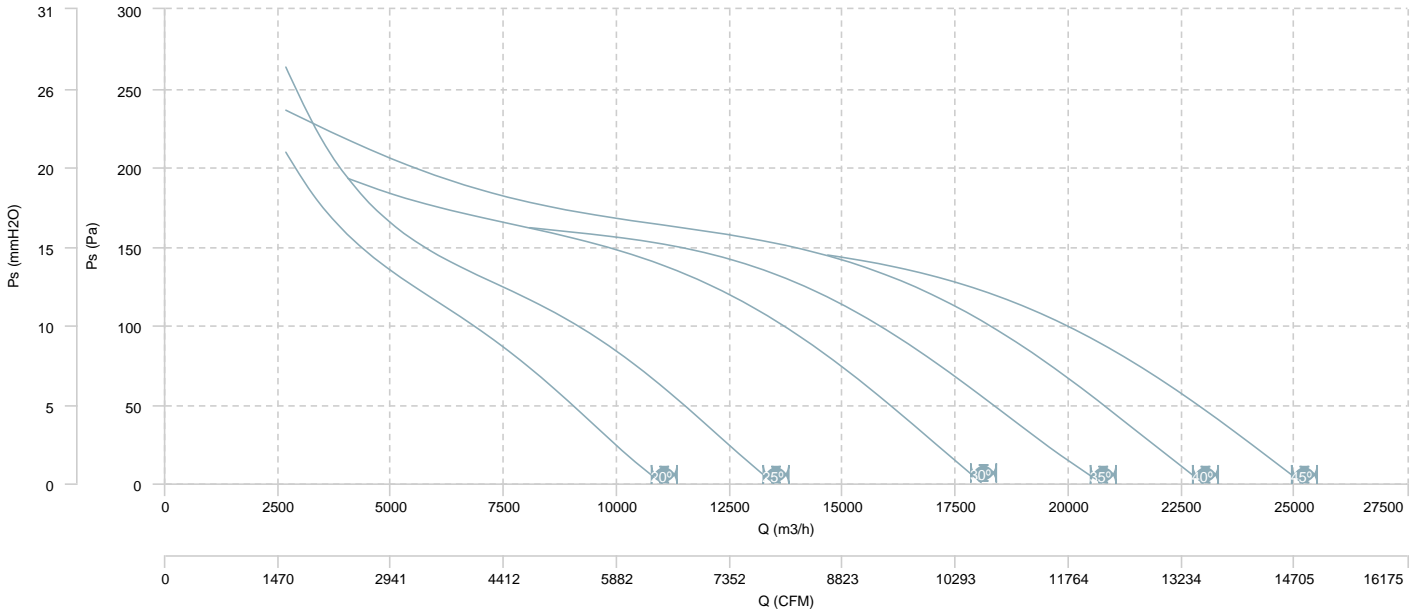

AIR FLOW - MECHANICAL POWER

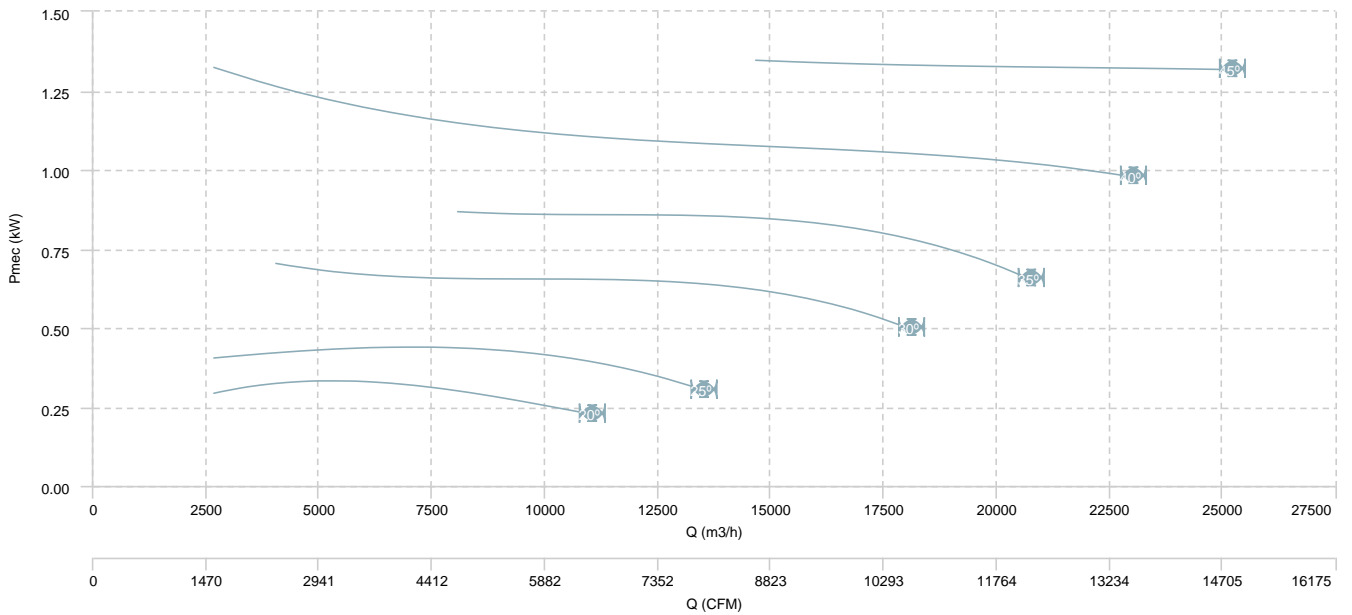

HC 80 T6 (A2:9)

AIR FLOW - PRESSURE

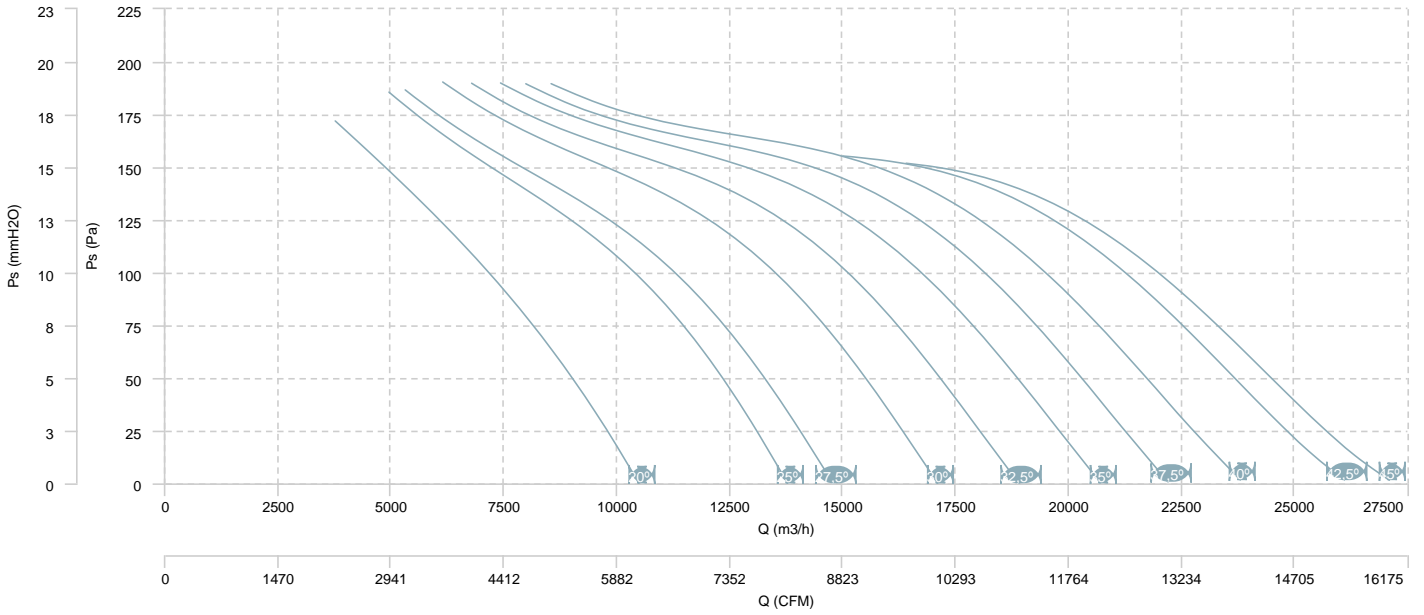

AIR FLOW - MECHANICAL POWER

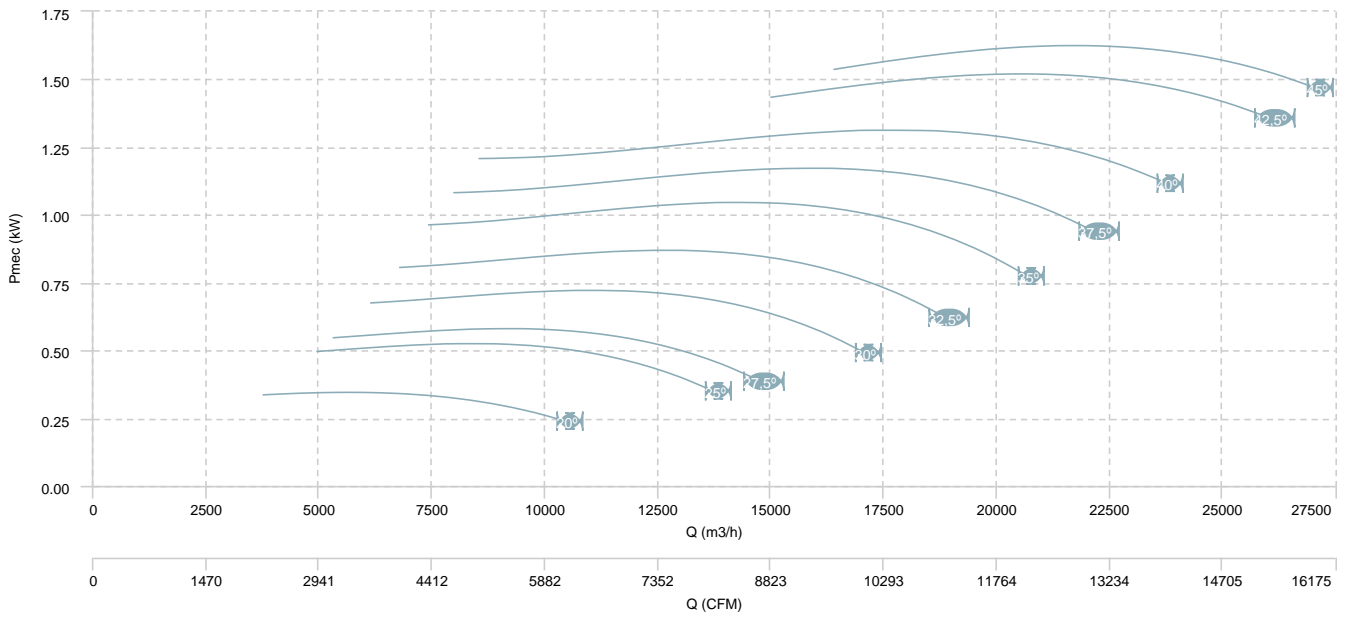

HC 80 T6 (A2:6)

AIR FLOW - PRESSURE

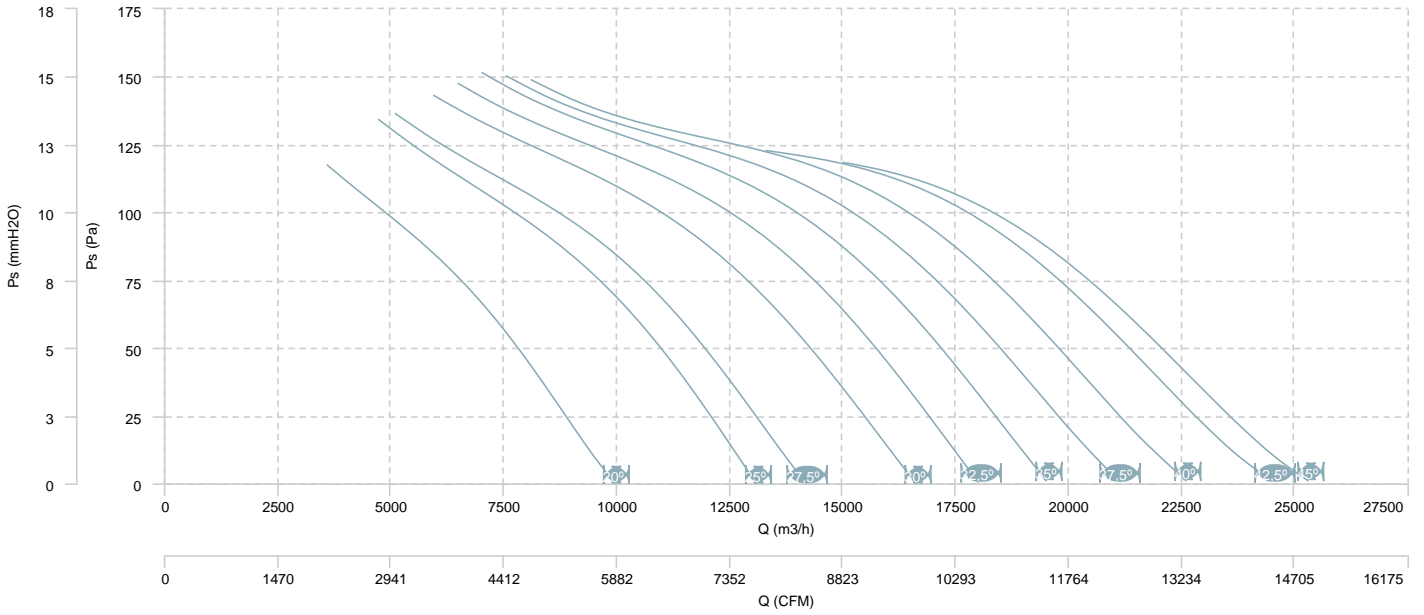

AIR FLOW - MECHANICAL POWER

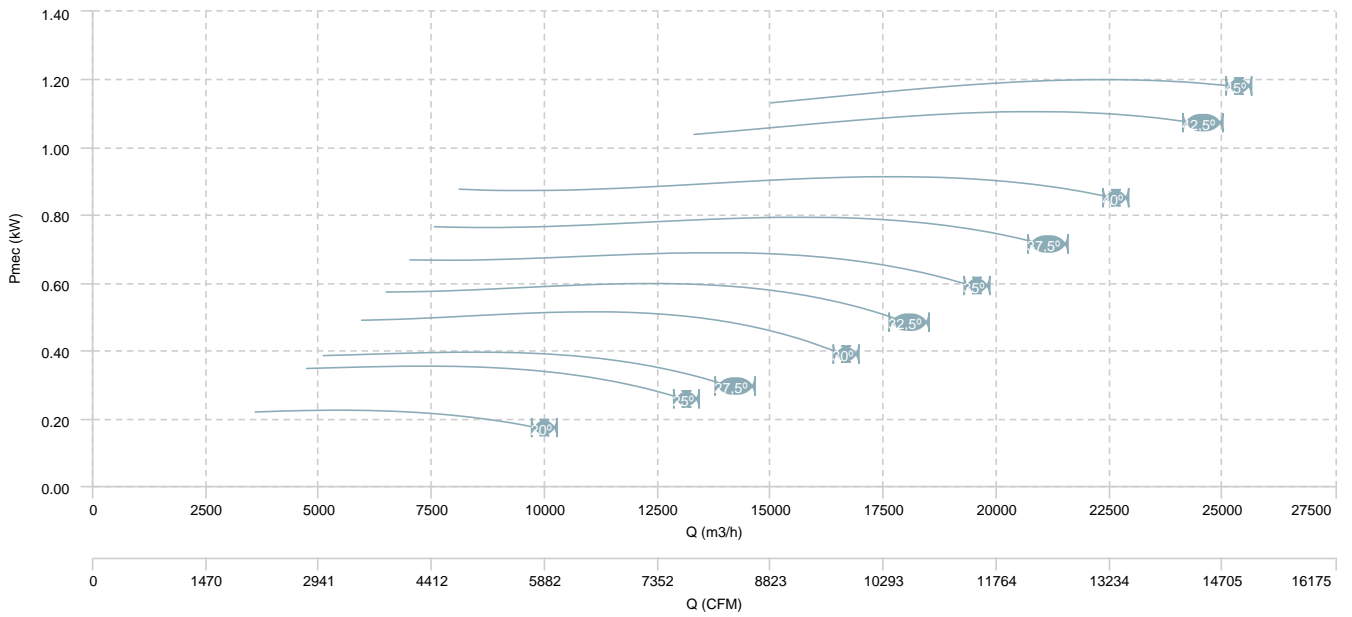

HC 80 T4/T8 (A2:6)

AIR FLOW - PRESSURE (4 poles)

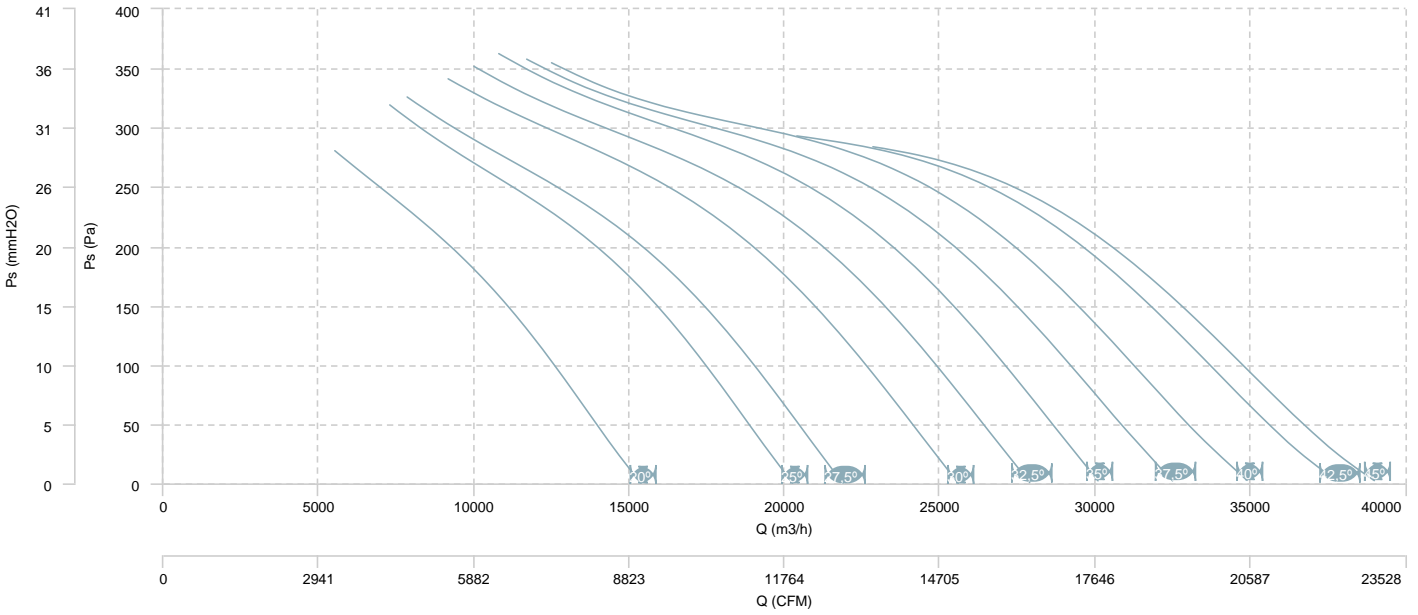

AIR FLOW - MECHANICAL POWER (4 poles)

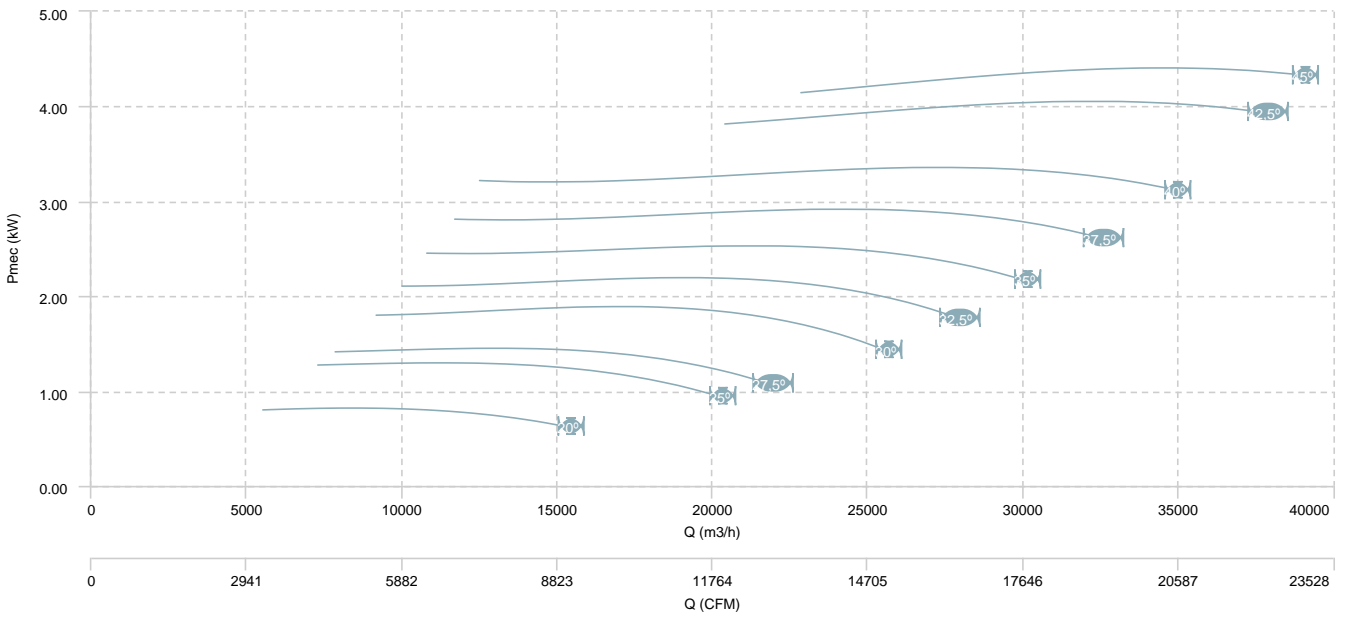

HC 80 T4/T8 (A2:6)

AIR FLOW - PRESSURE (8 poles)

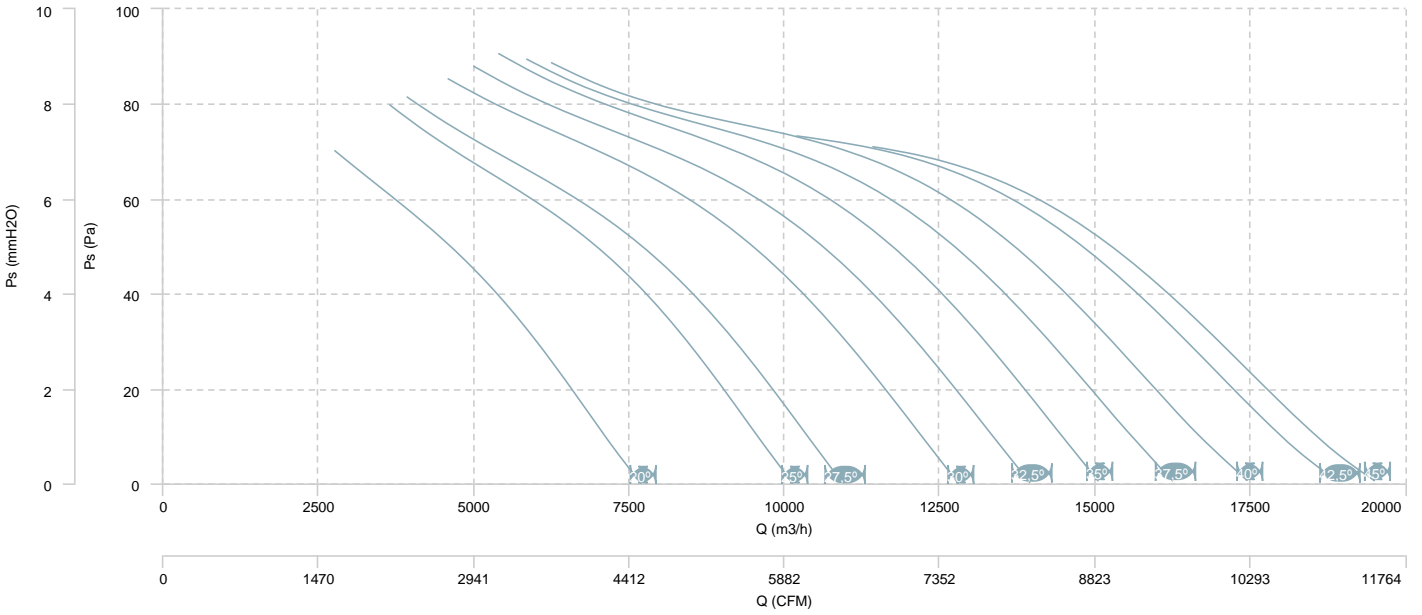

AIR FLOW - MECHANICAL POWER (8 poles)

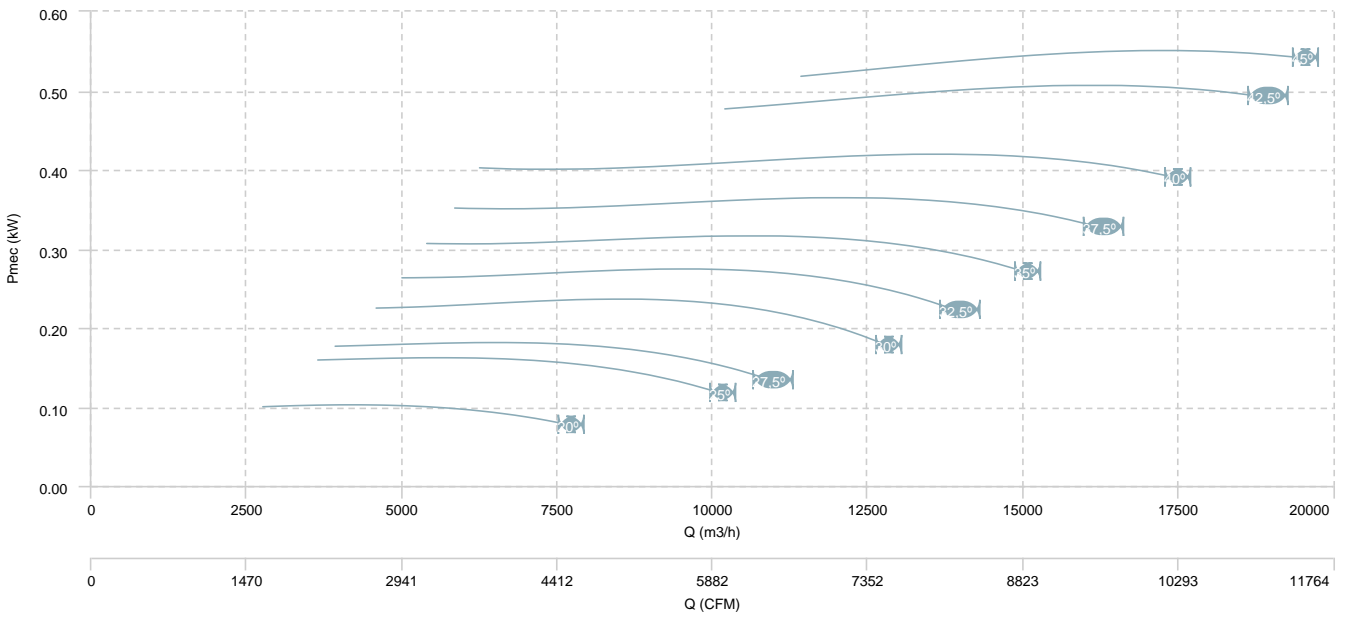

HC 80 T4/T8 (A2:9)

AIR FLOW - PRESSURE (4 poles)

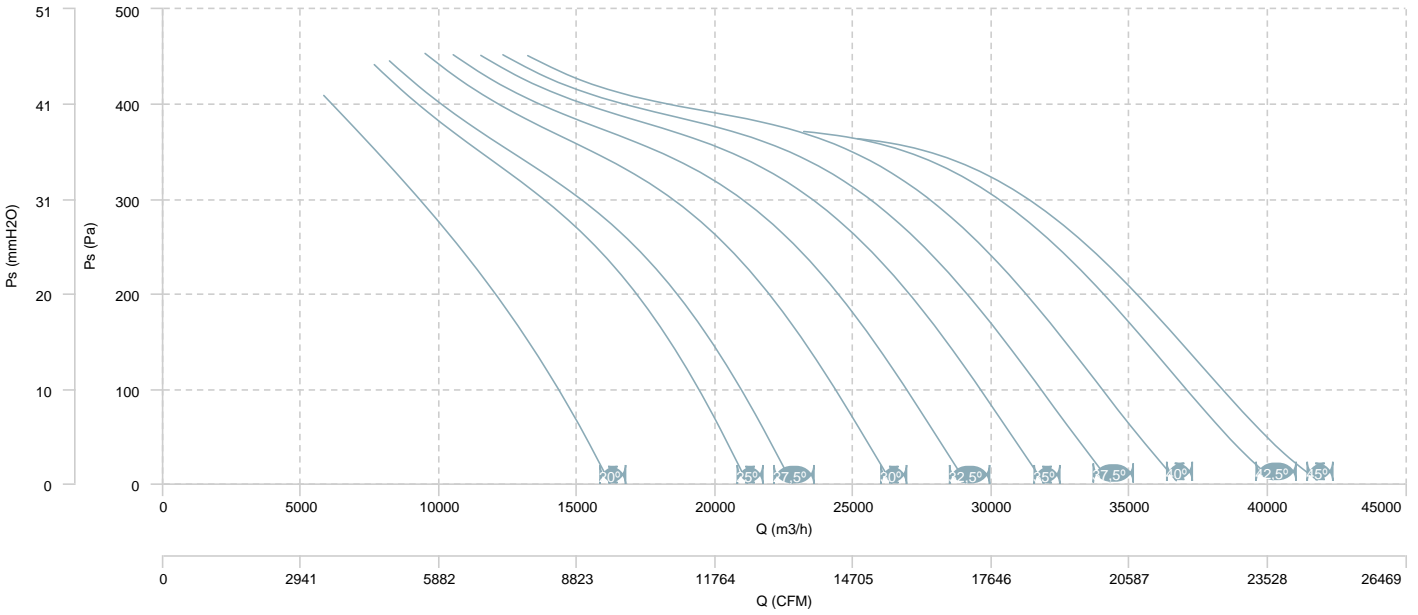

AIR FLOW - MECHANICAL POWER (4 poles)

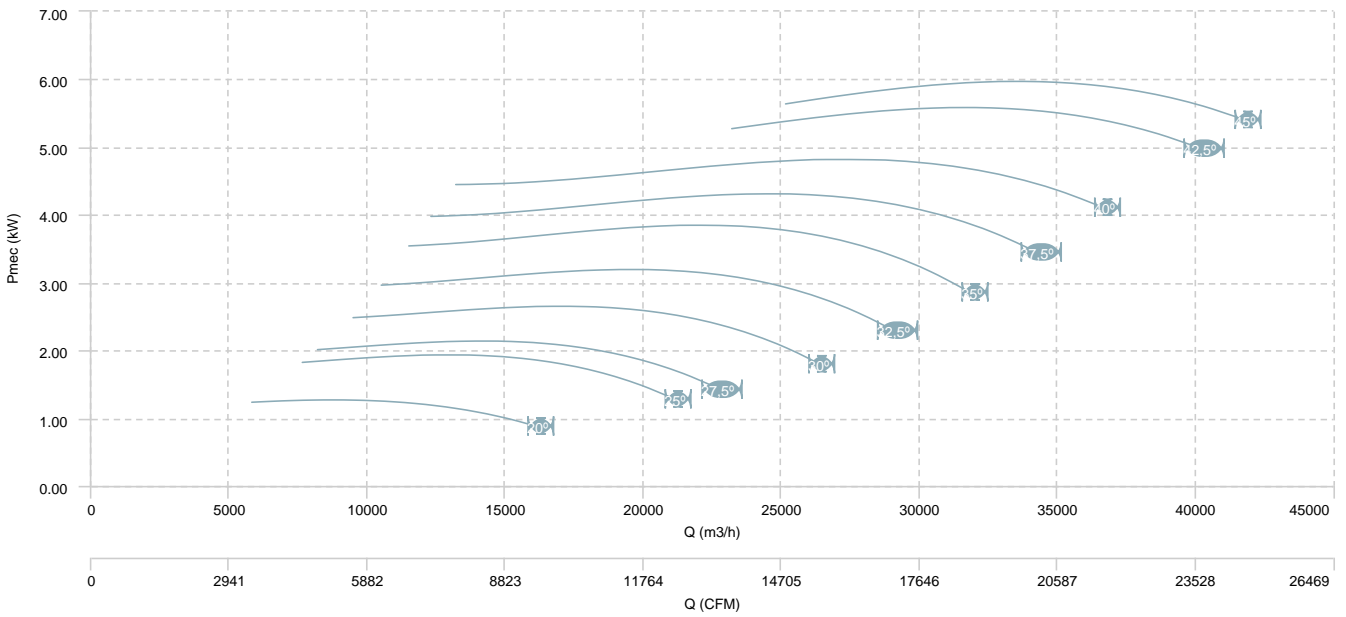

HC 80 T4/T8 (A2:9)

AIR FLOW - PRESSURE (8 poles)

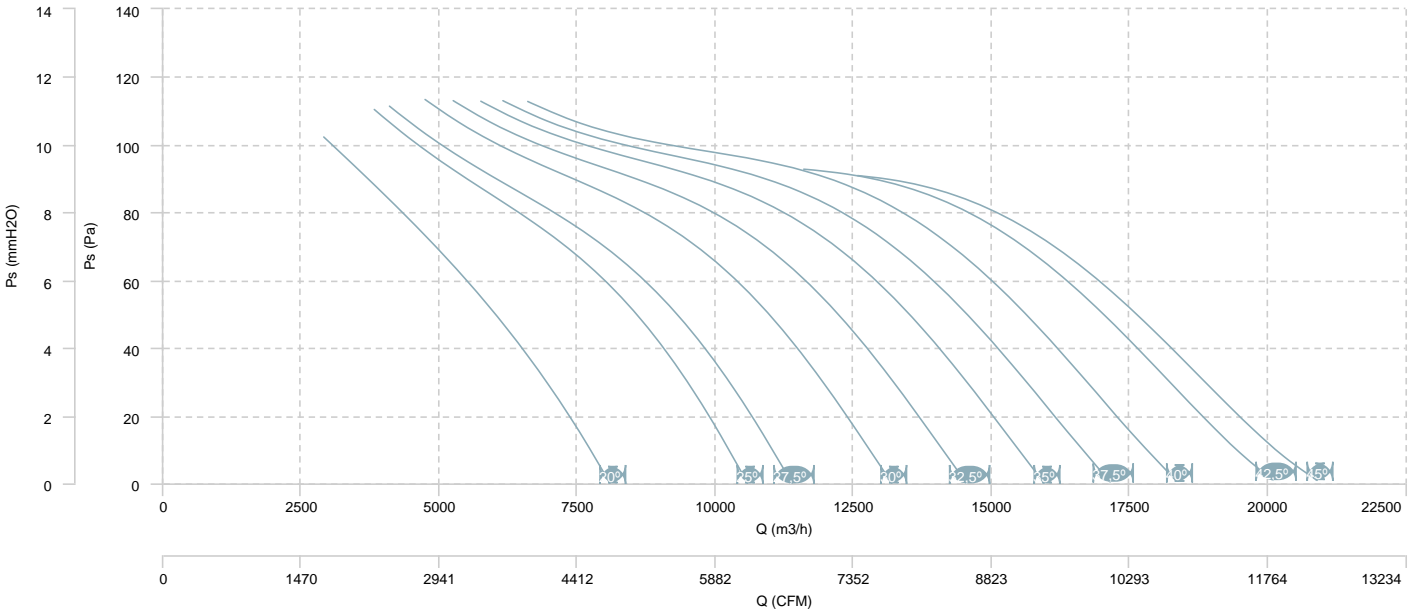

AIR FLOW - MECHANICAL POWER (8 poles)

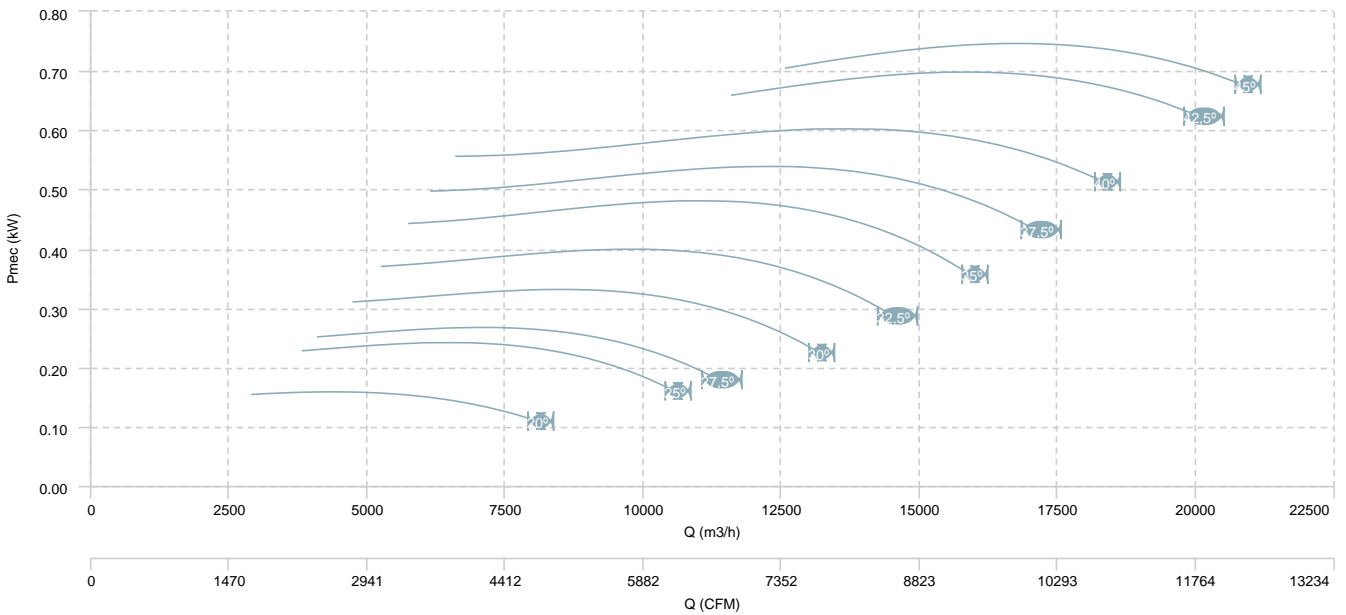

HC 80 T4/T8 (A5:6)

AIR FLOW - PRESSURE (4 poles)

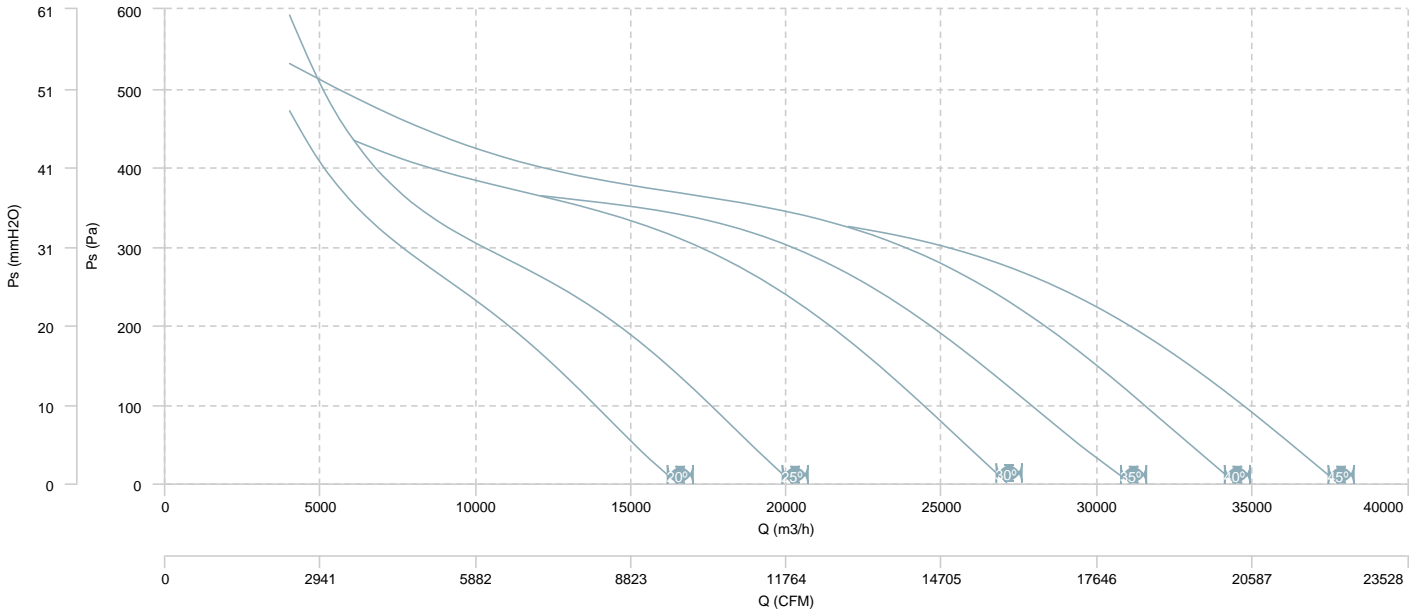

AIR FLOW - MECHANICAL POWER (4 poles)

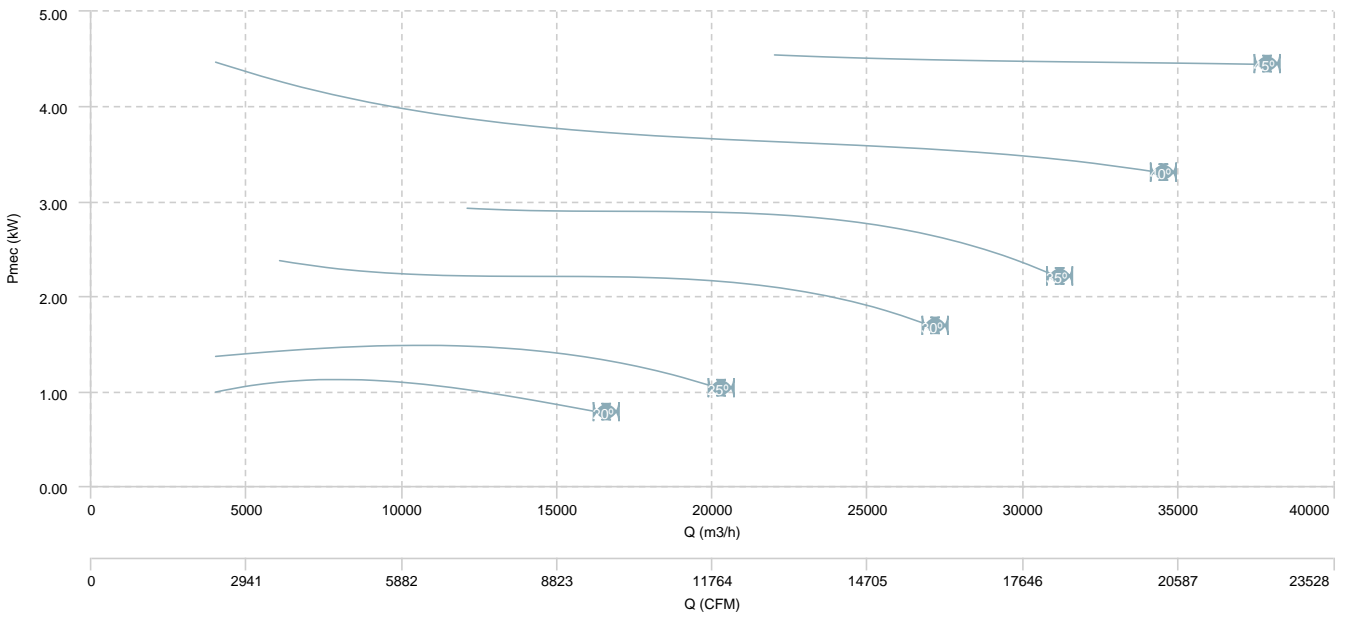

HC 80 T4/T8 (A5:6)

AIR FLOW - PRESSURE (8 poles)

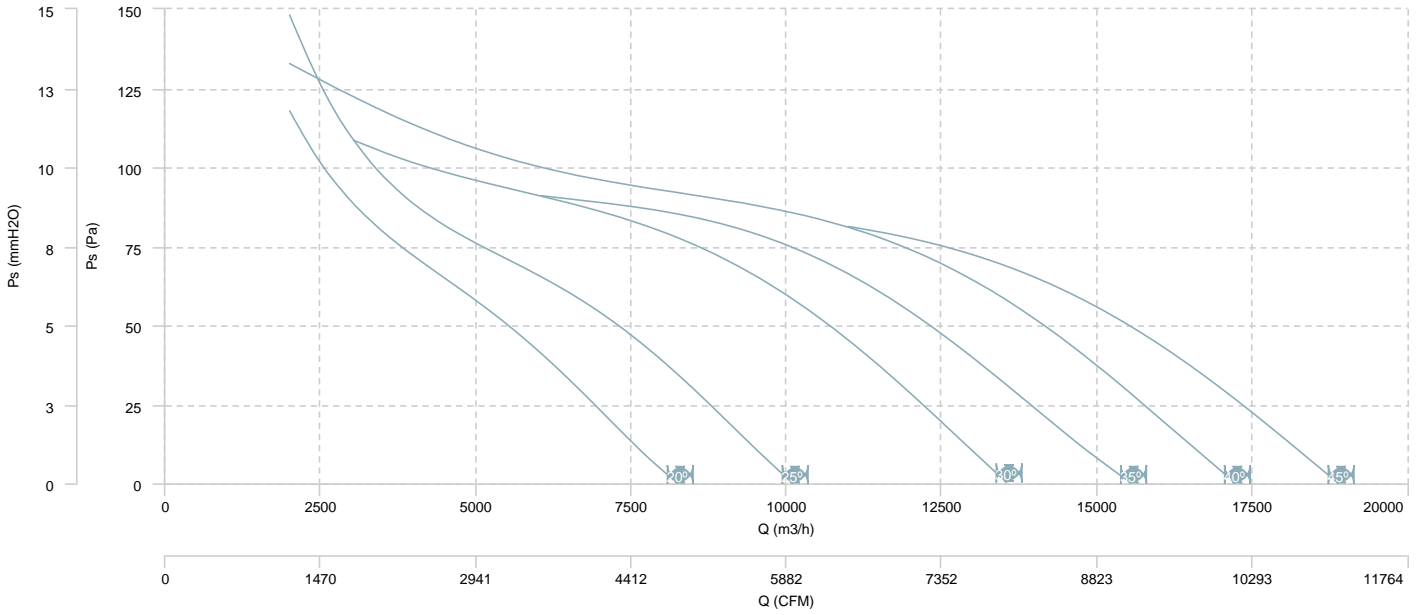

AIR FLOW - MECHANICAL POWER (8 poles)

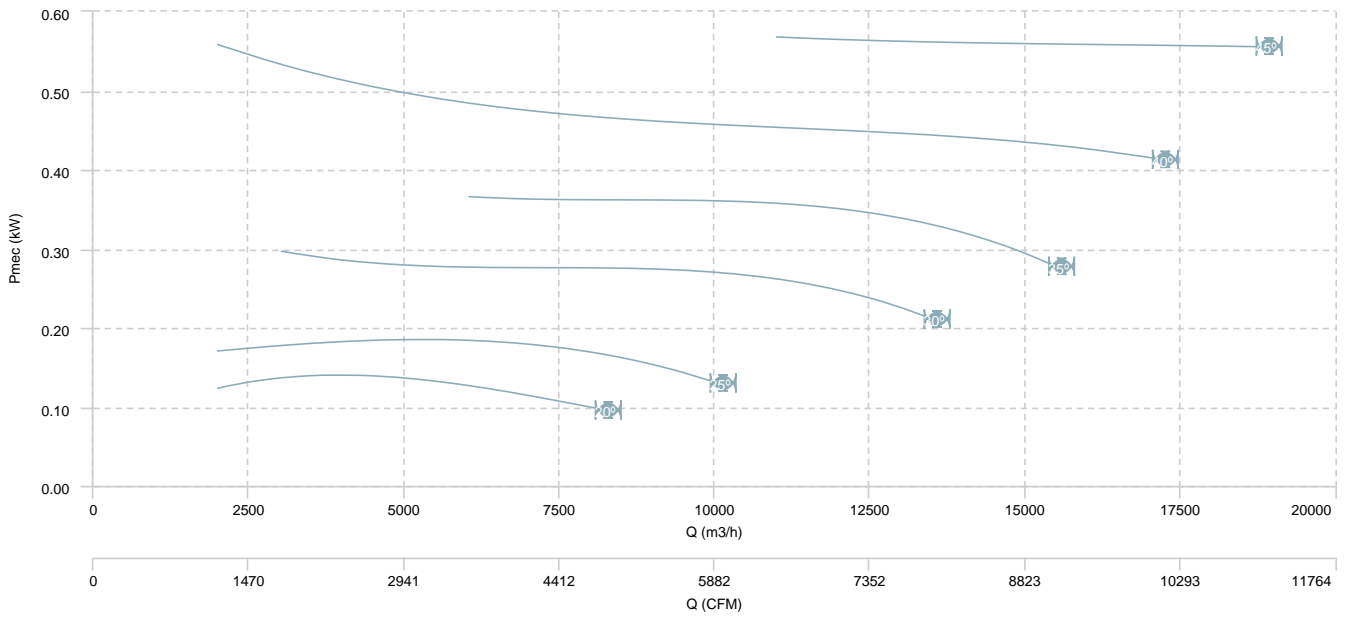

HC 90 T4 (A6:3)

AIR FLOW - PRESSURE

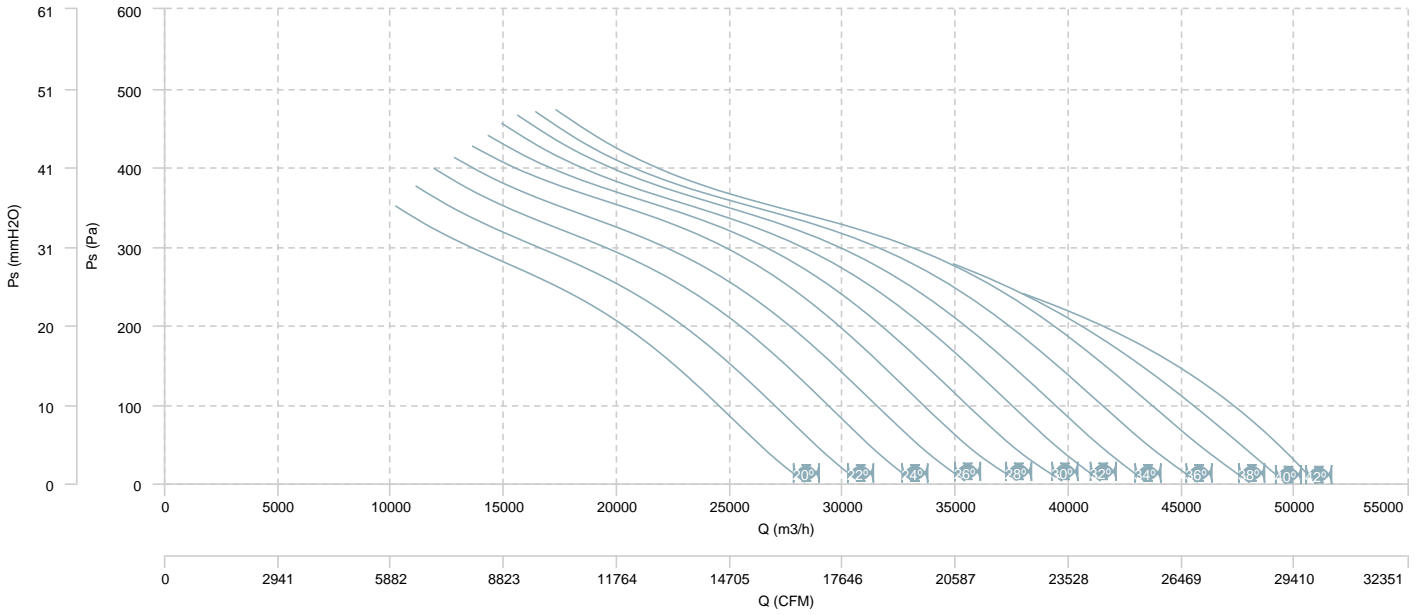

AIR FLOW - MECHANICAL POWER

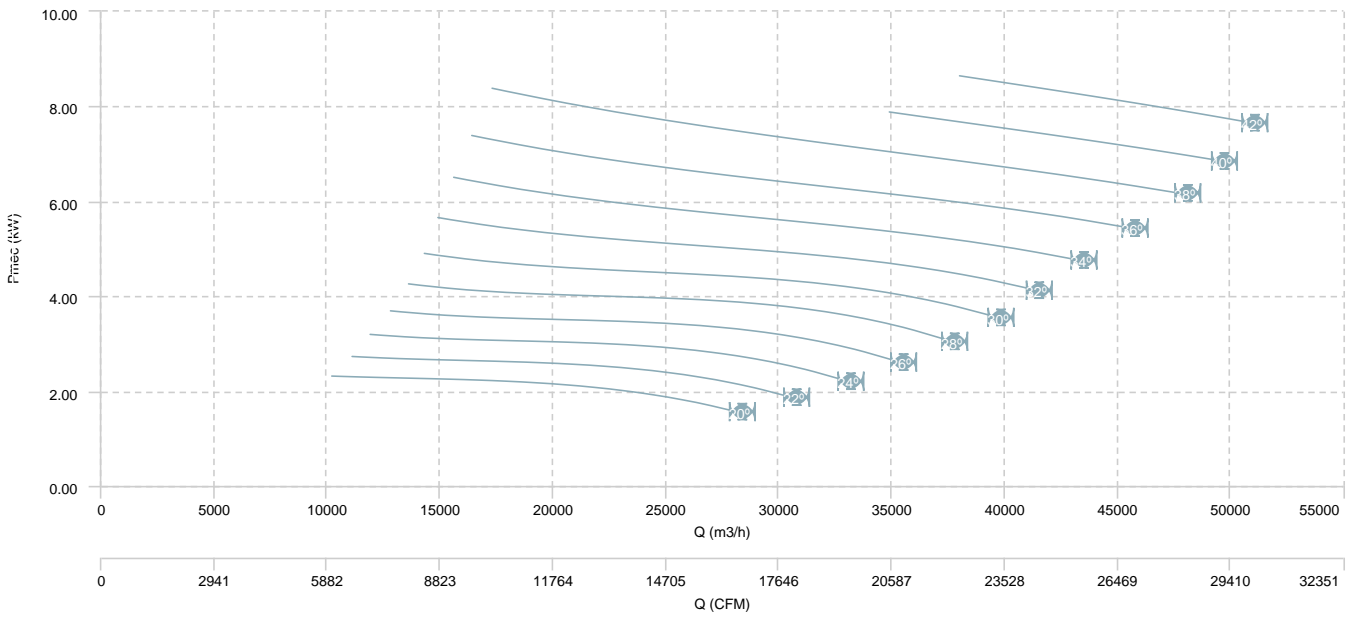

HC 90 T4 (A6:6)

AIR FLOW - PRESSURE

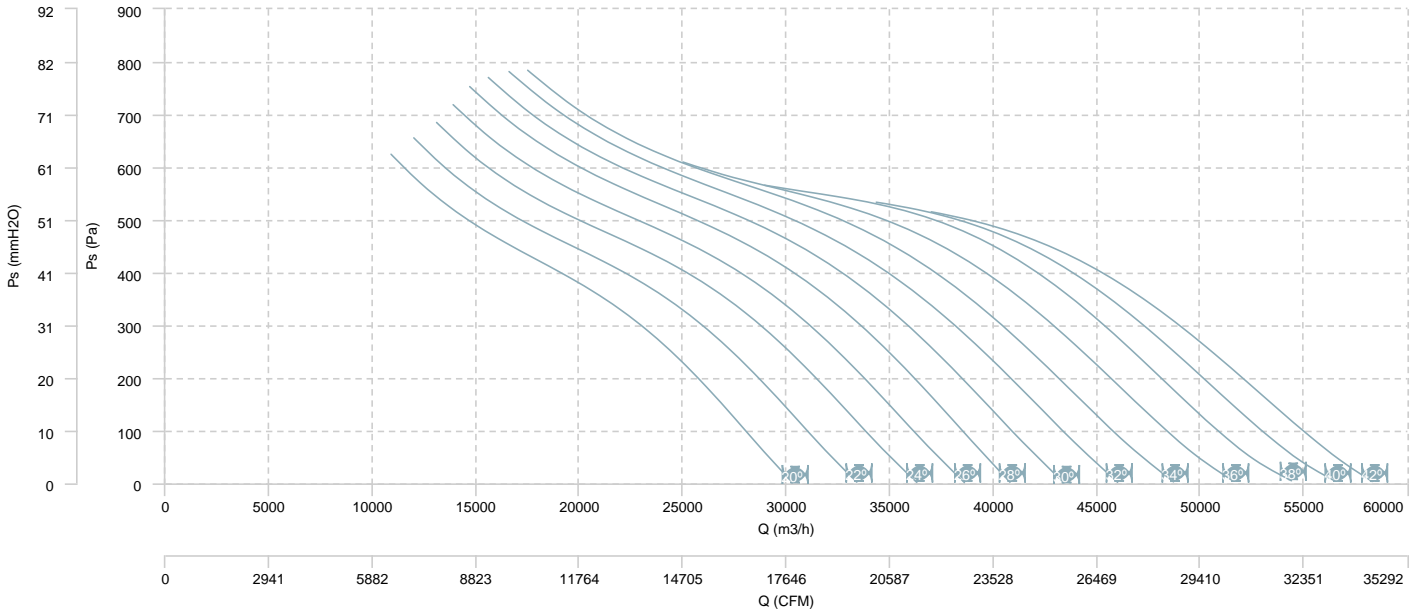

AIR FLOW - MECHANICAL POWER

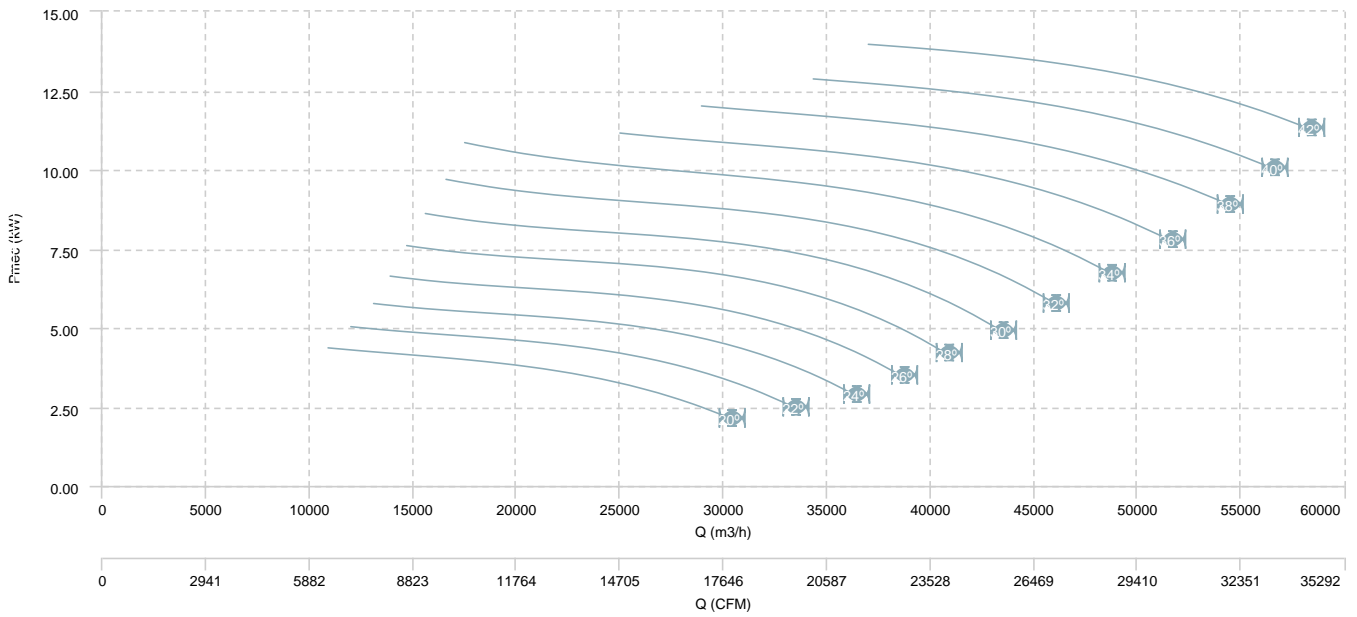

HC 90 T6 (A6:3)

AIR FLOW - PRESSURE

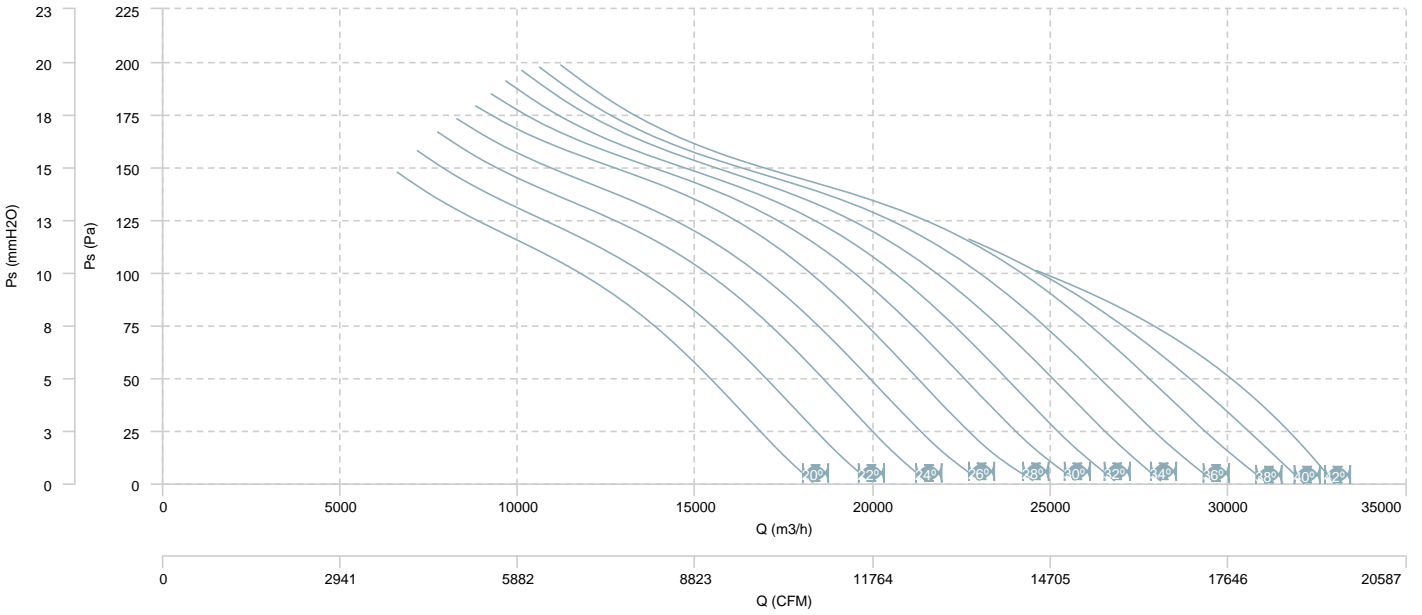

AIR FLOW - MECHANICAL POWER

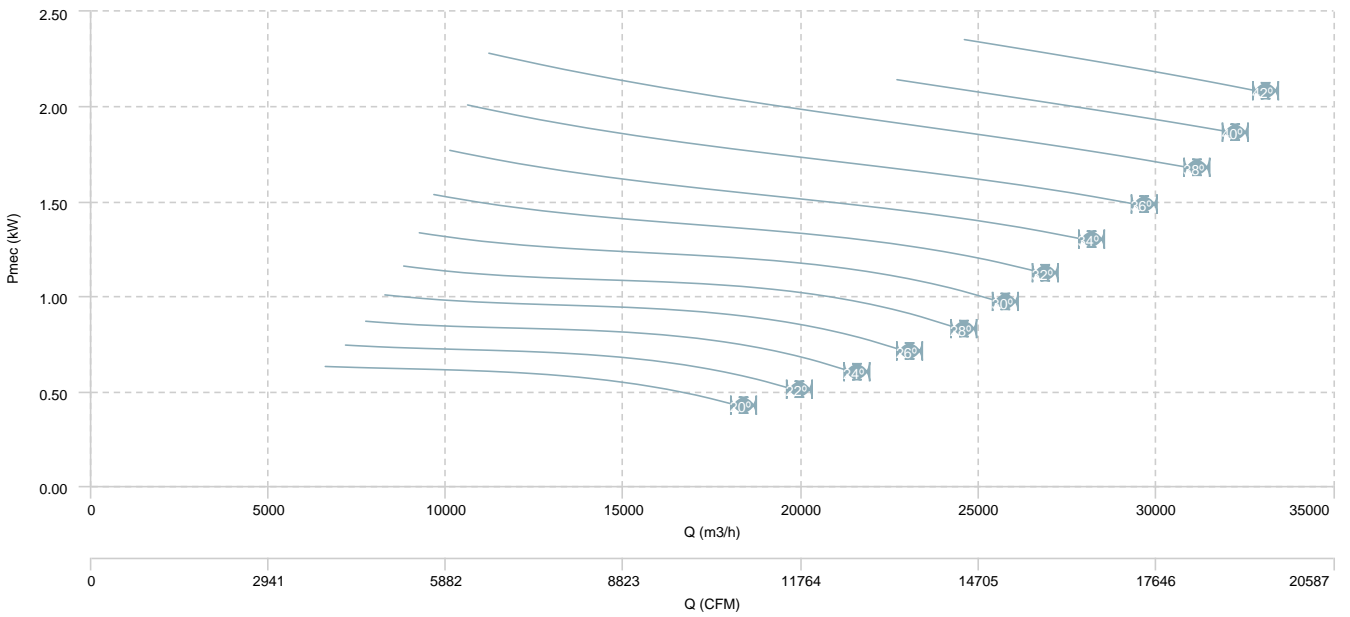

HC 90 T6 (A6:6)

AIR FLOW - PRESSURE

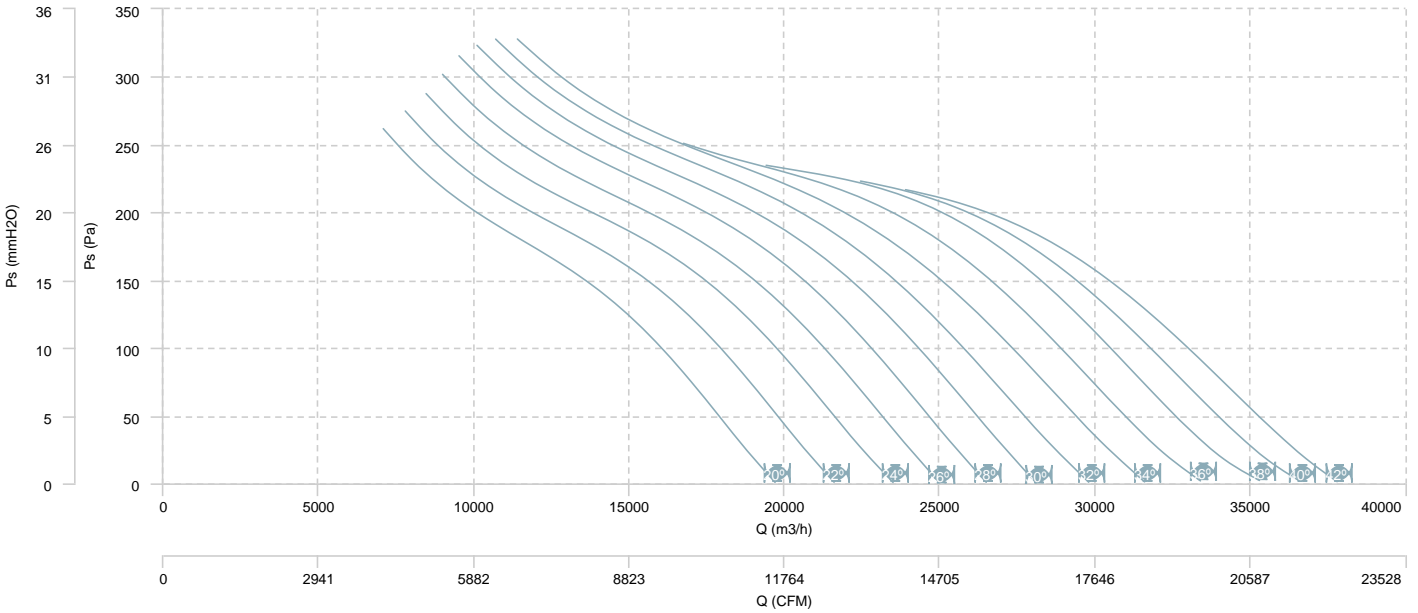

AIR FLOW - MECHANICAL POWER

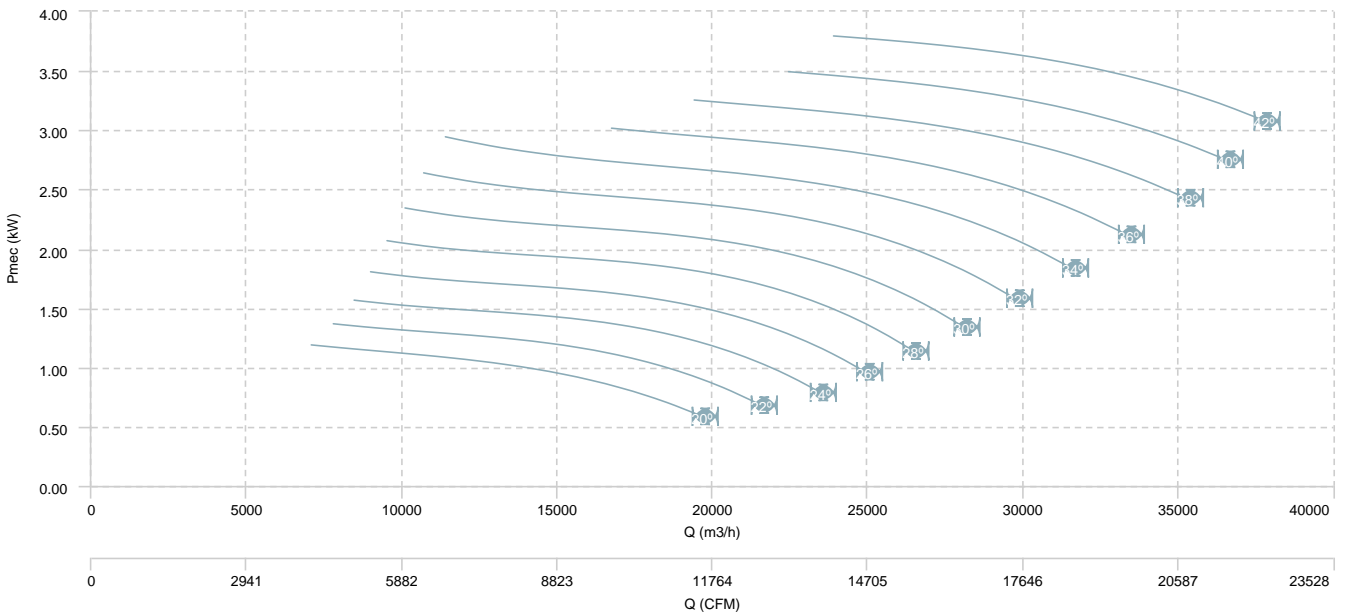

HC 90 T4/T8 (A6:6)

AIR FLOW - PRESSURE (4 poles)

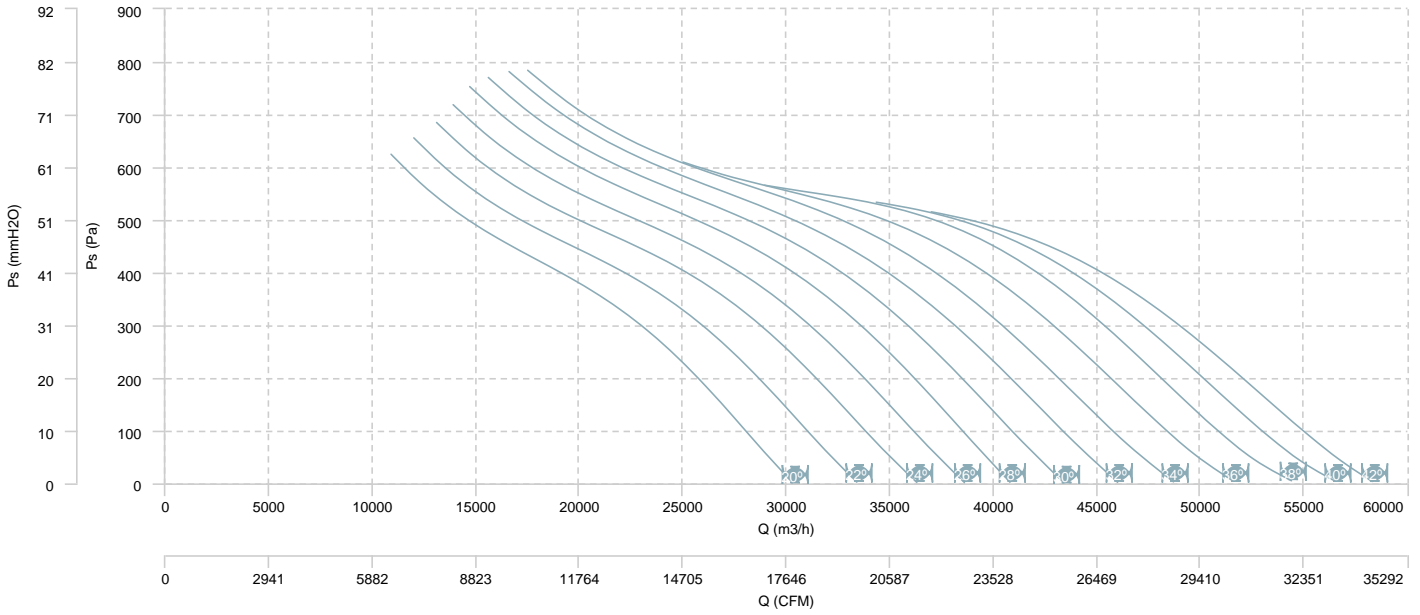

AIR FLOW - MECHANICAL POWER (4 poles)

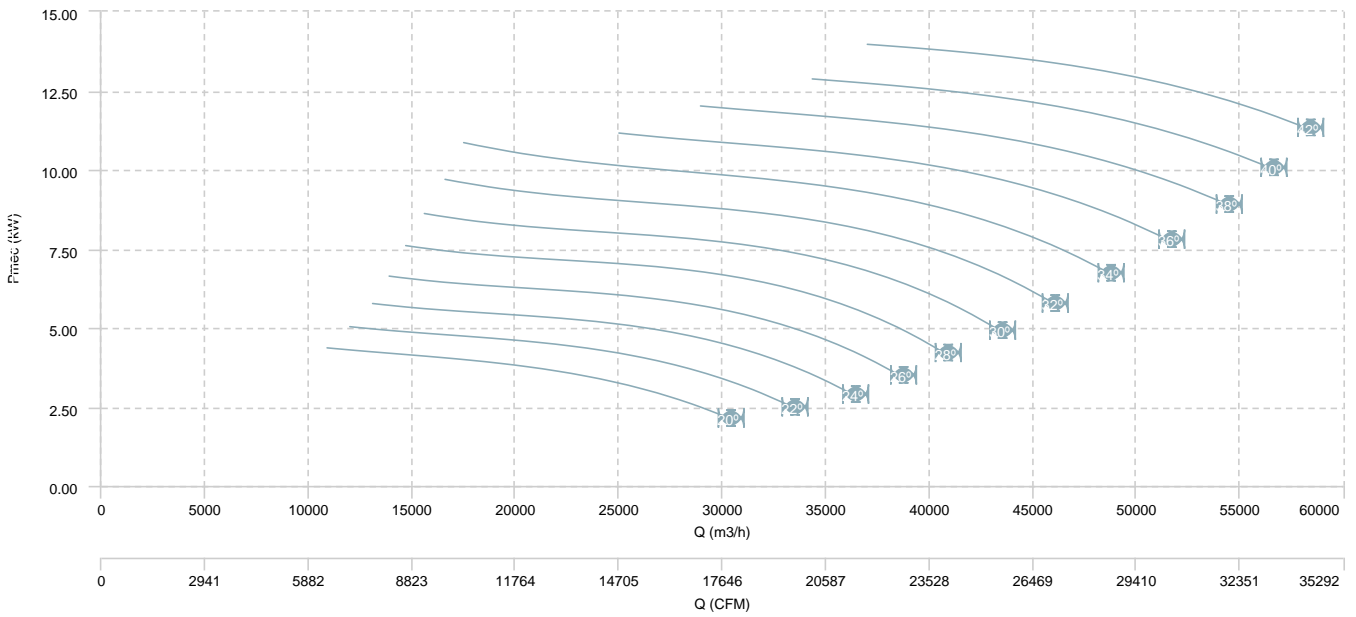

HC 90 T4/T8 (A6:6)

AIR FLOW - PRESSURE (8 poles)

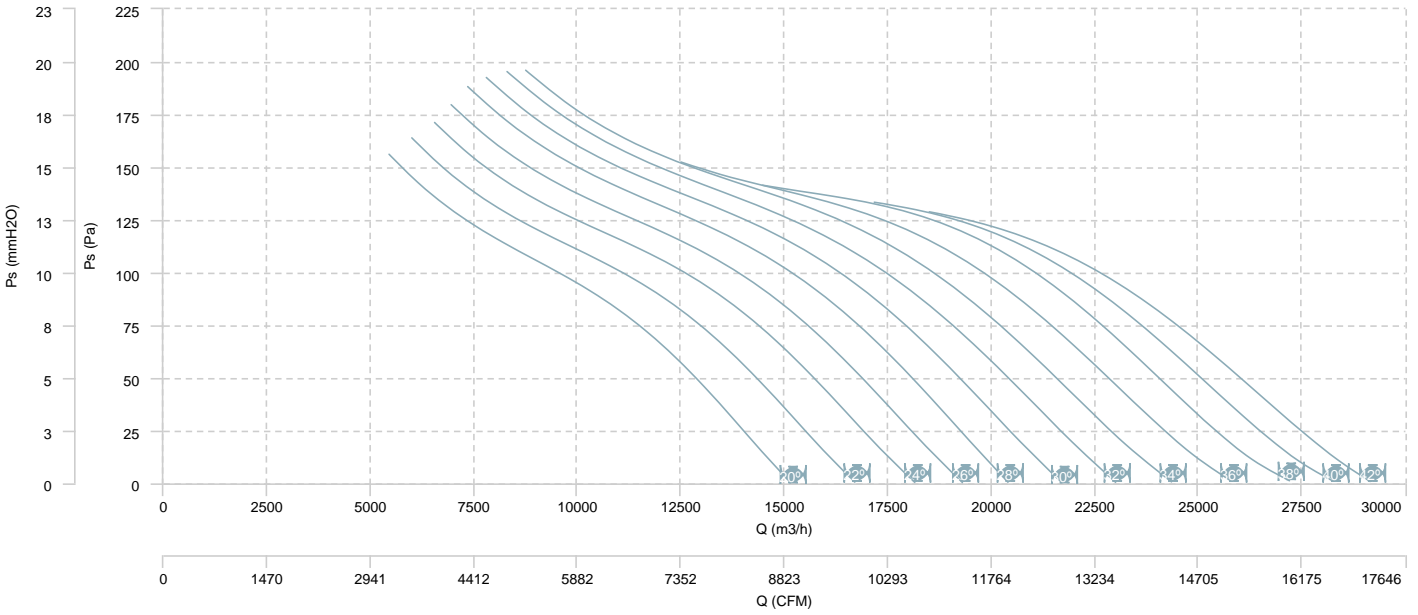

AIR FLOW - MECHANICAL POWER (8 poles)

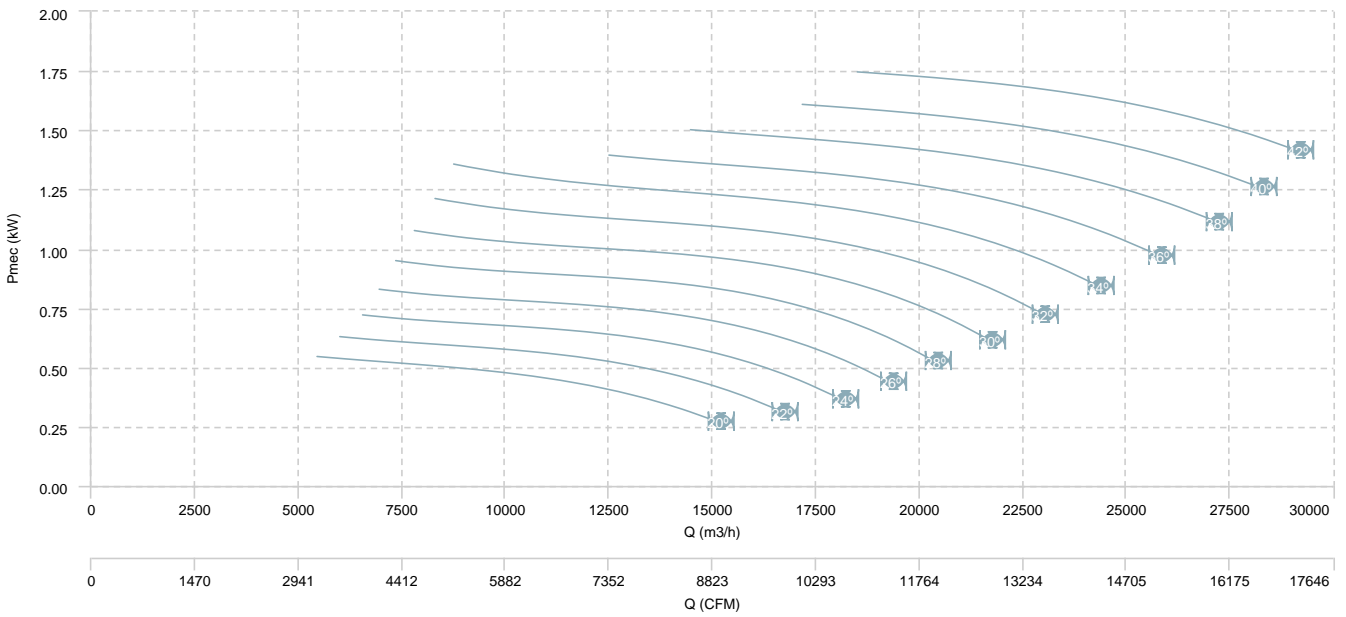

HC 90 T4/T8 (A6:3)

AIR FLOW - PRESSURE (4 poles)

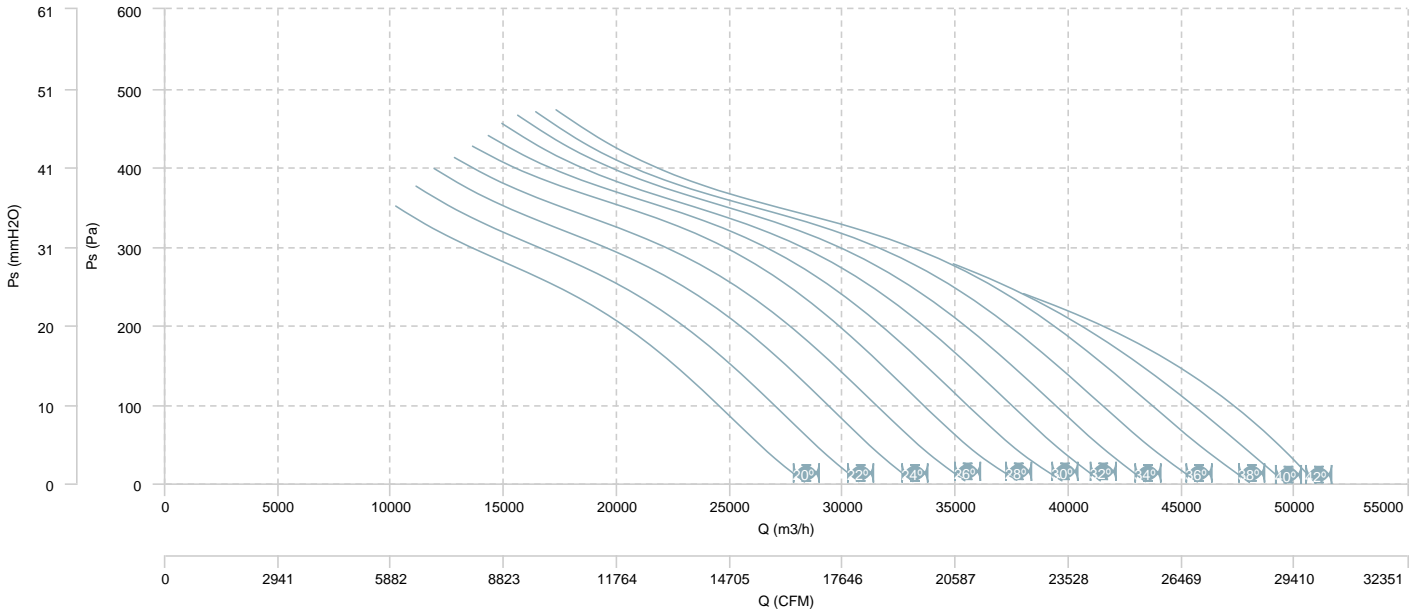

AIR FLOW - MECHANICAL POWER (4 poles)

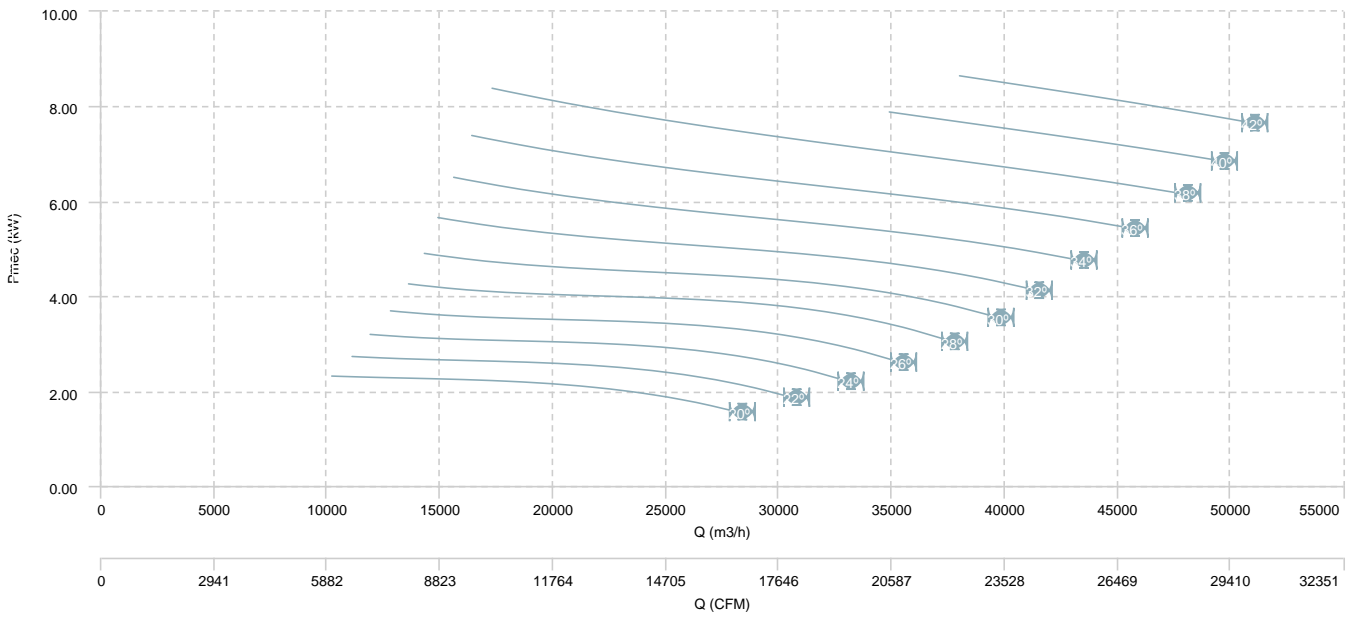

HC 90 T4/T8 (A6:3)

AIR FLOW - PRESSURE (8 poles)

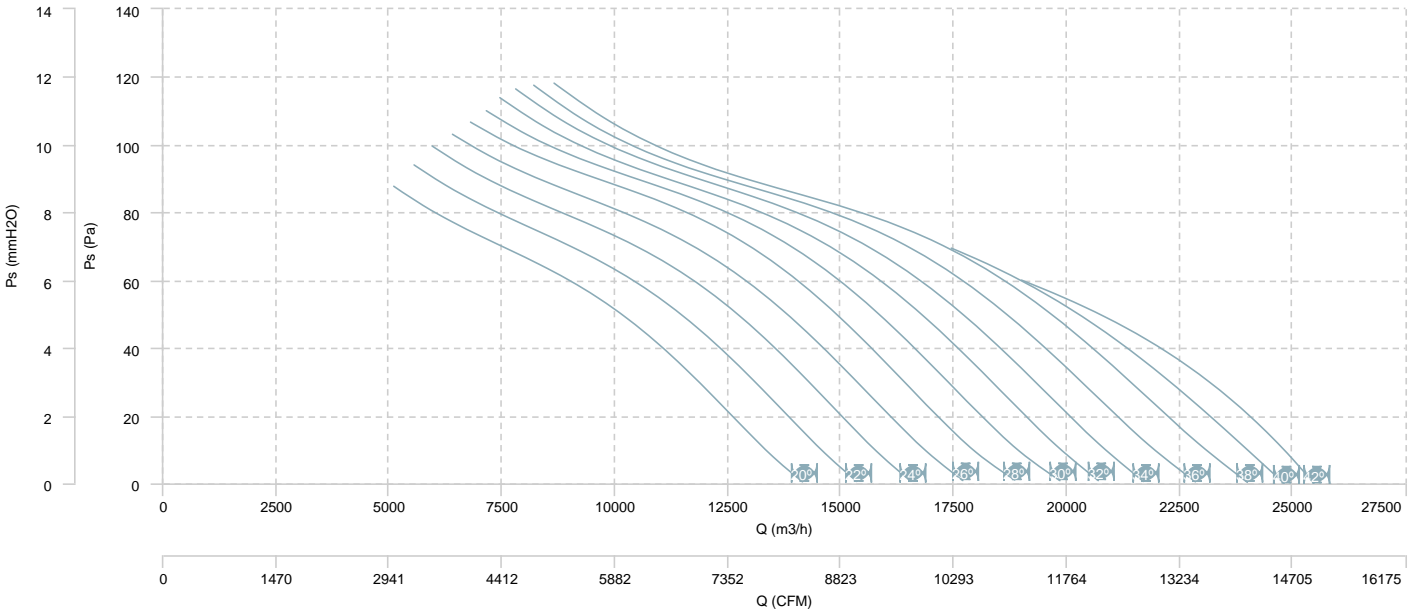

AIR FLOW - MECHANICAL POWER (8 poles)

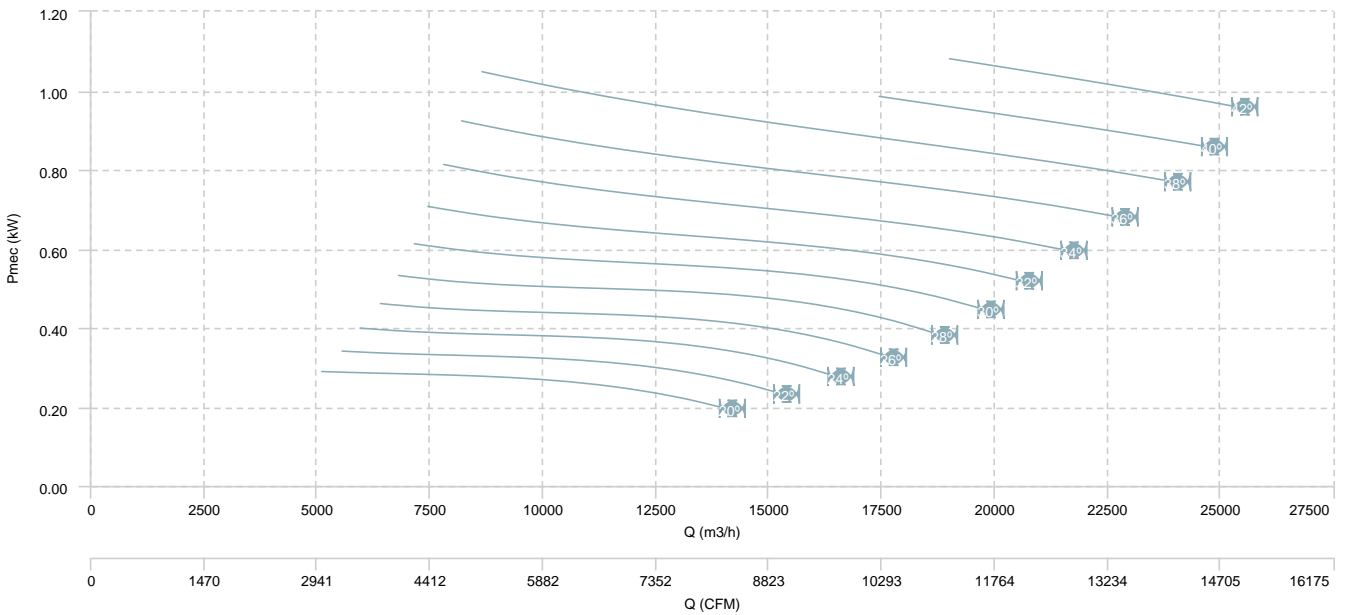

HC 100 T4 (A6:3)

AIR FLOW - PRESSURE

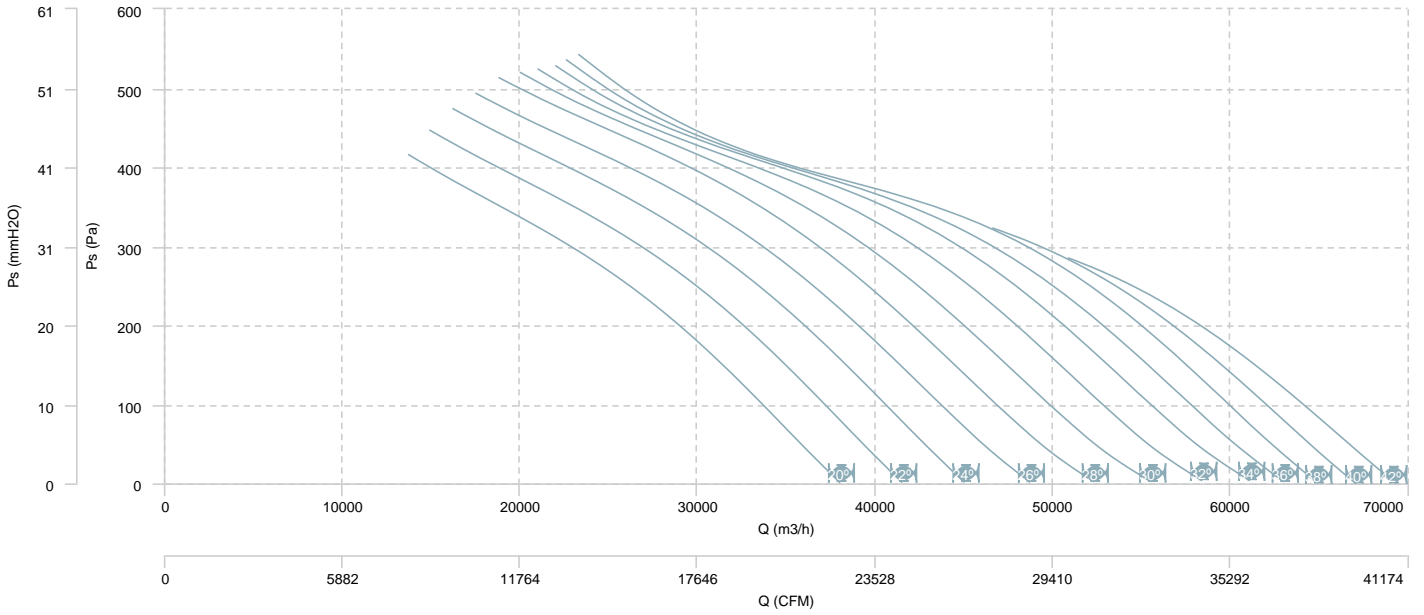

AIR FLOW - MECHANICAL POWER

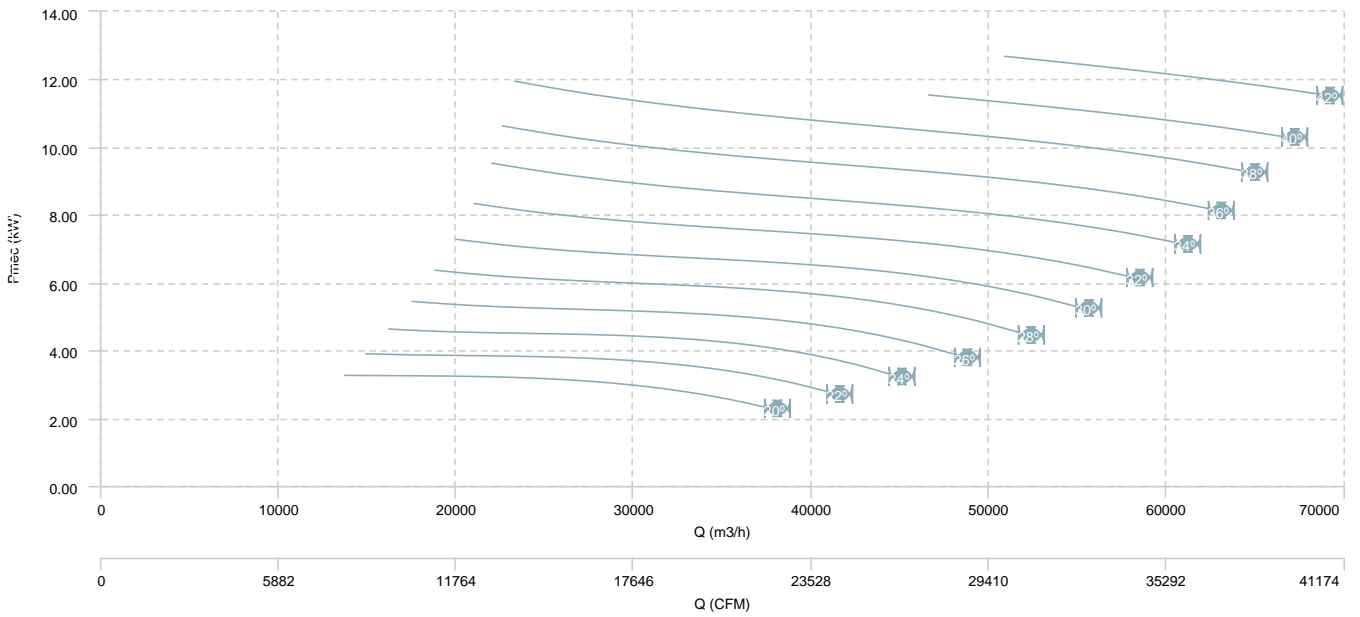

HC 100 T4 (A6:6)

AIR FLOW - PRESSURE

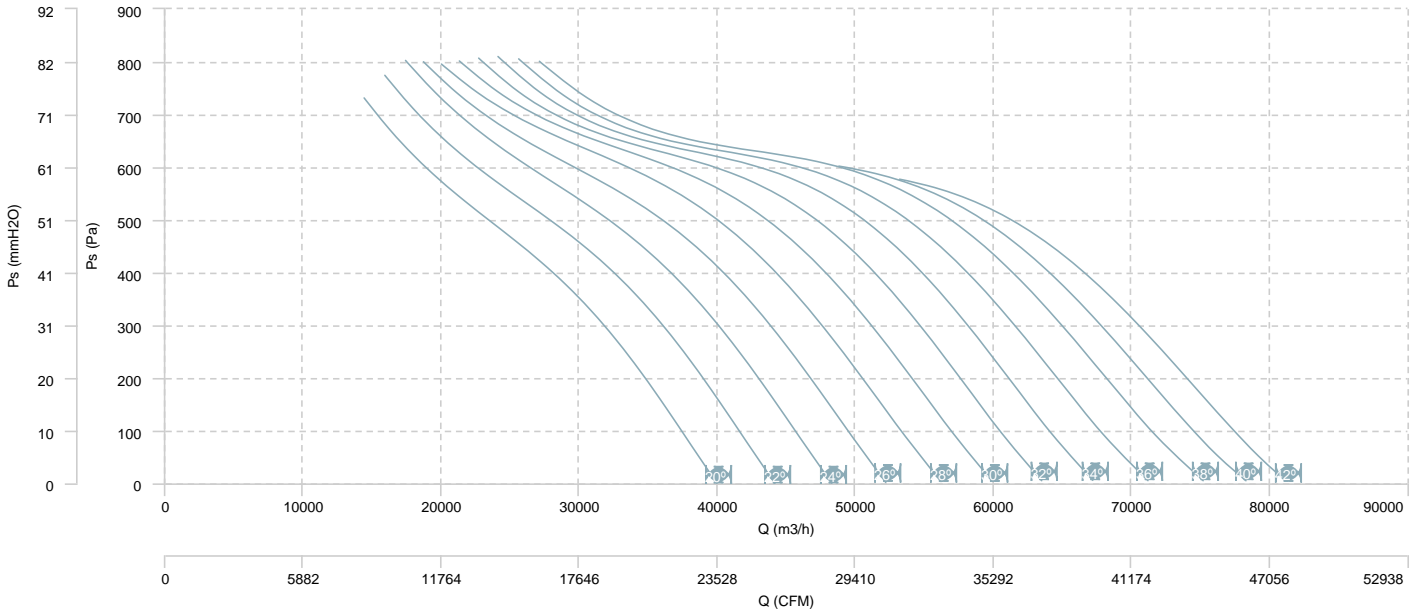

AIR FLOW - MECHANICAL POWER

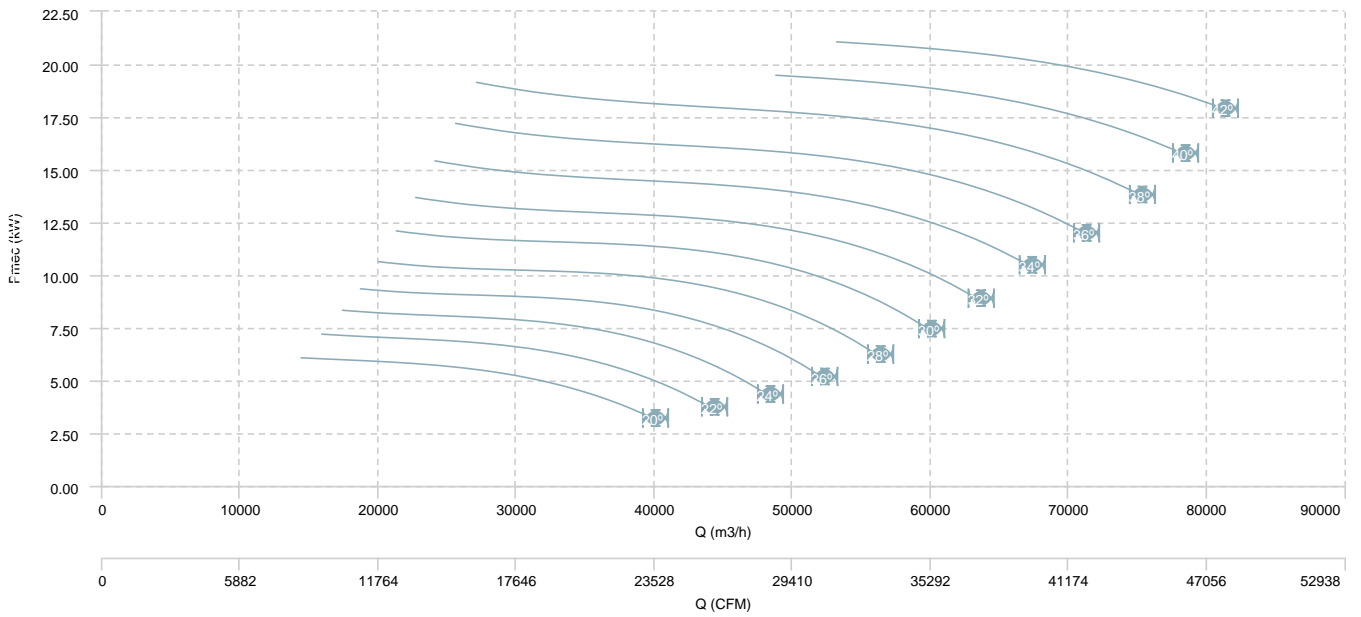

HC 100 T6 (A6:3)

AIR FLOW - PRESSURE

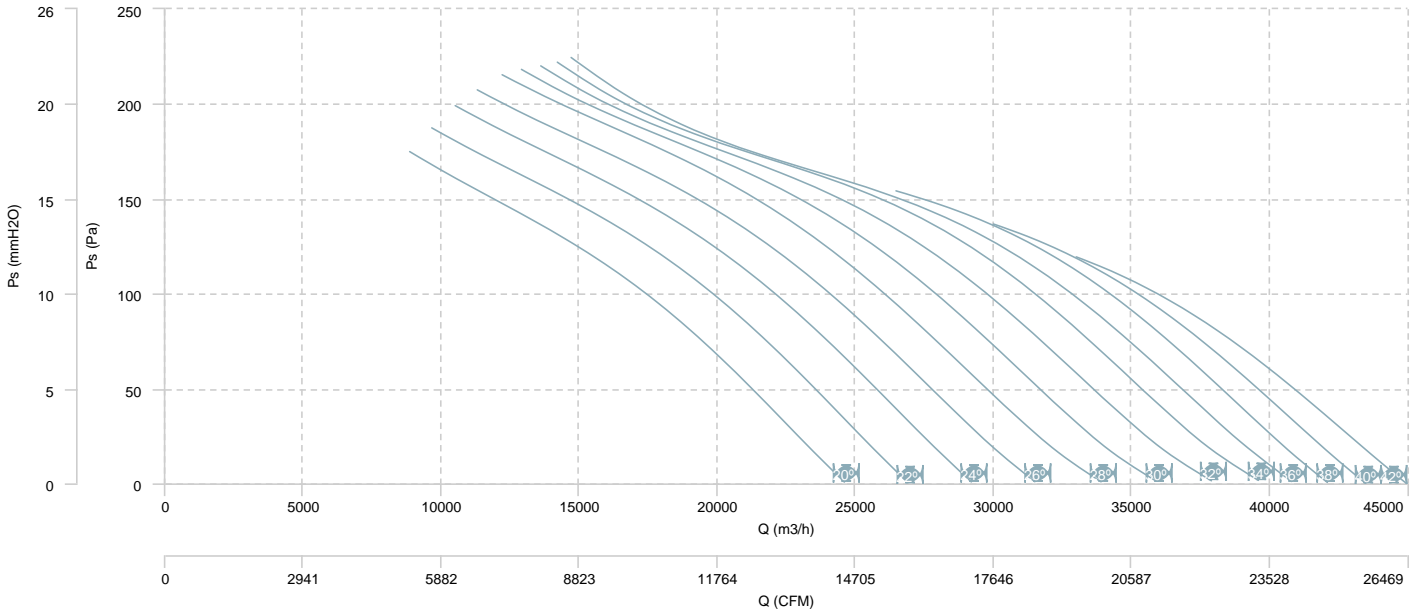

AIR FLOW - MECHANICAL POWER

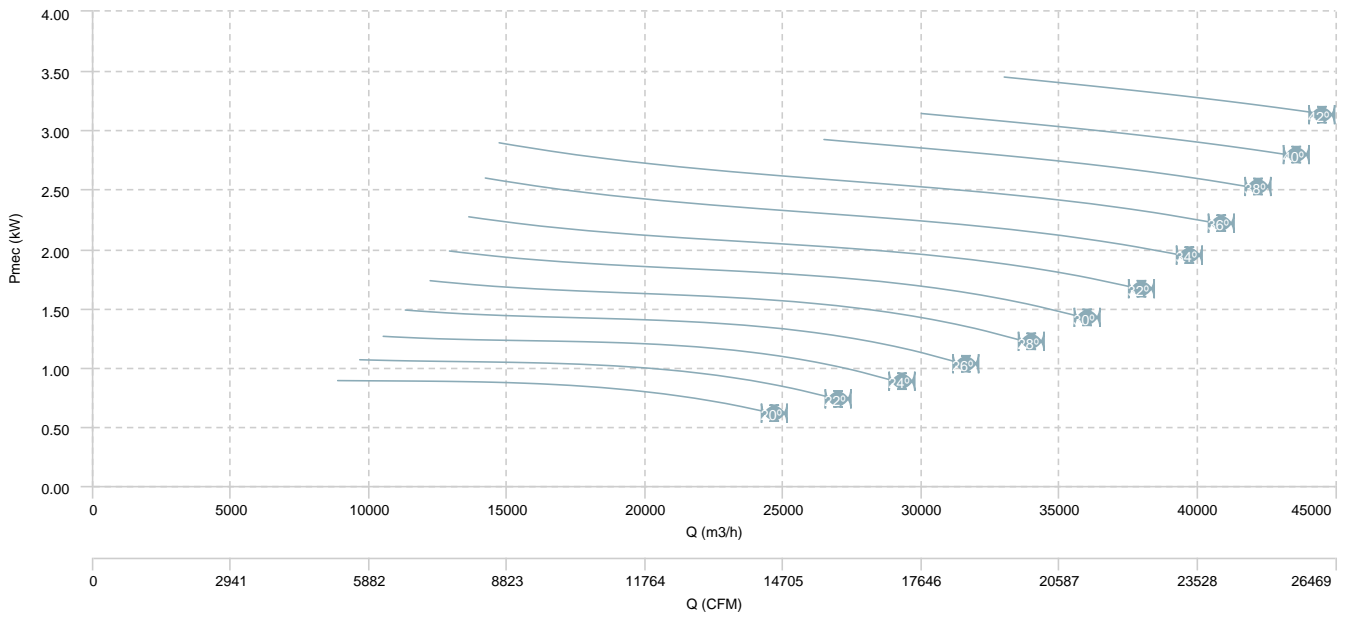

HC 100 T6 (A6:6)

AIR FLOW - PRESSURE

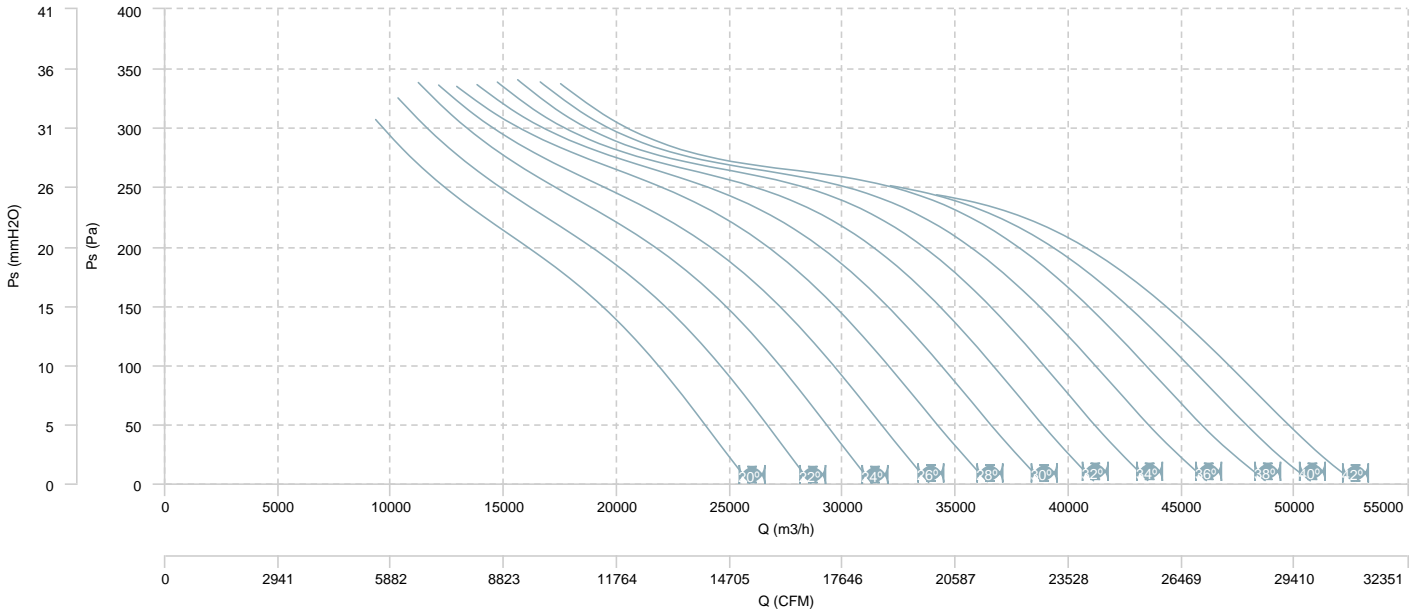

AIR FLOW - MECHANICAL POWER

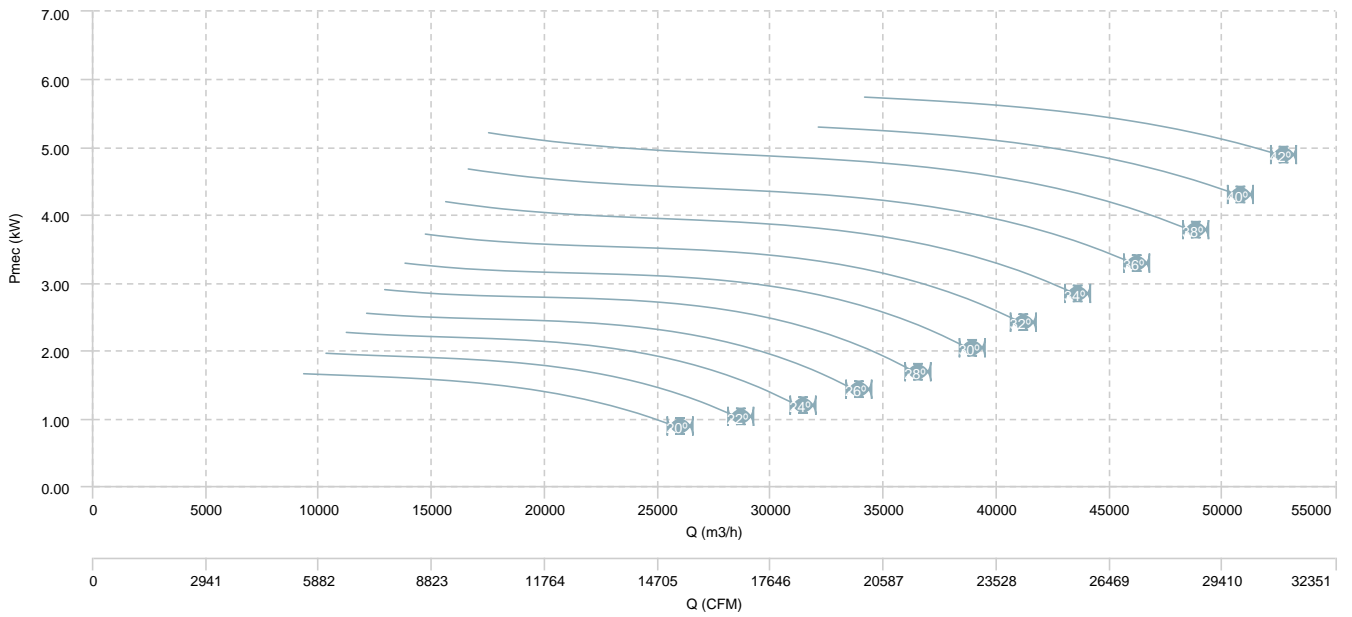

HC 100 T4/T8 (A6:3)

AIR FLOW - PRESSURE (4 poles)

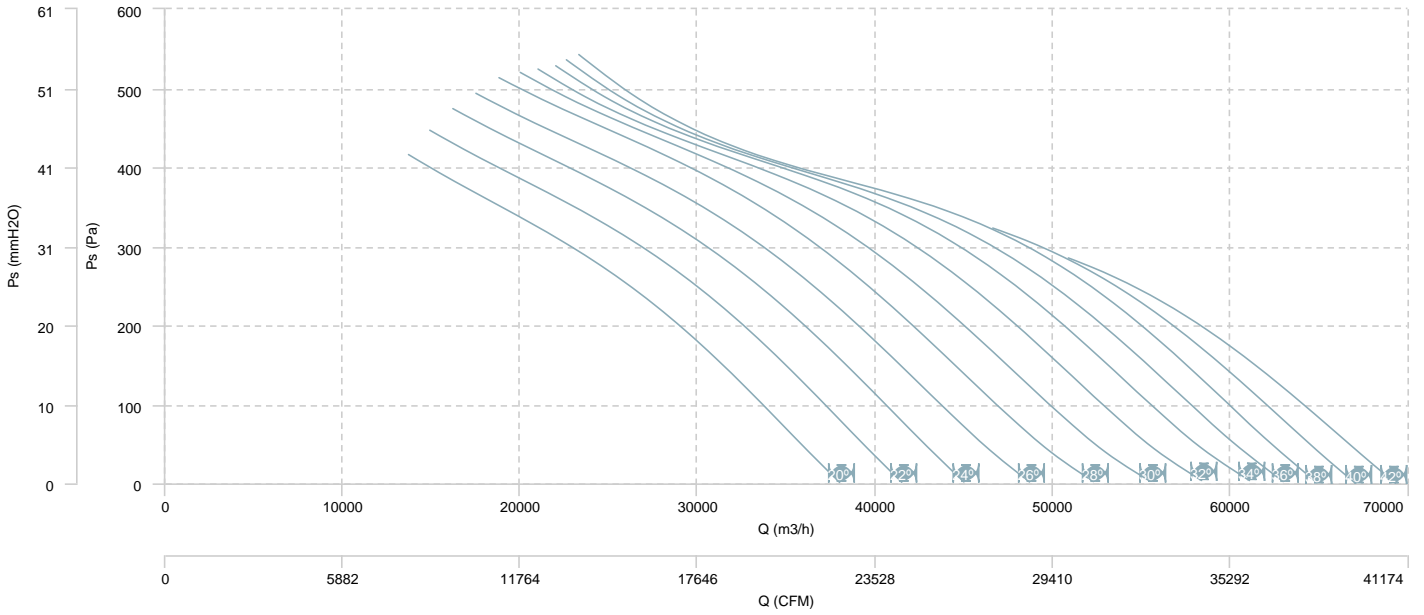

AIR FLOW - MECHANICAL POWER (4 poles)

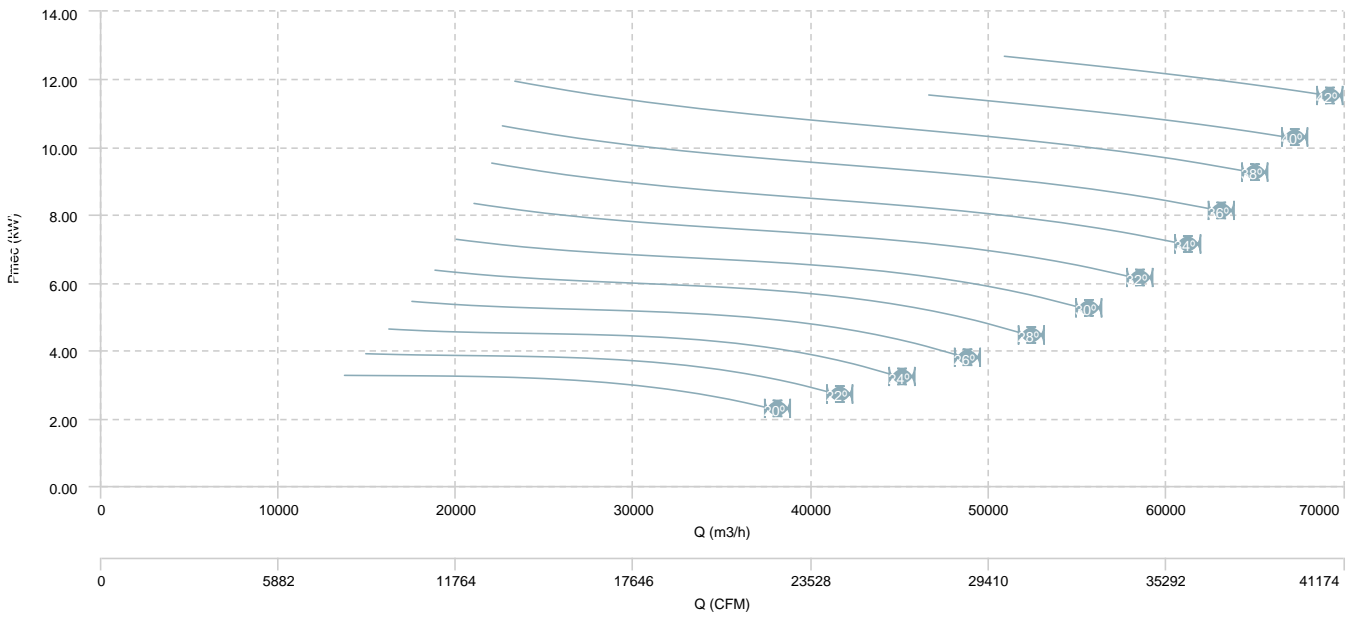

HC 100 T4/T8 (A6:3)

AIR FLOW - PRESSURE (8 poles)

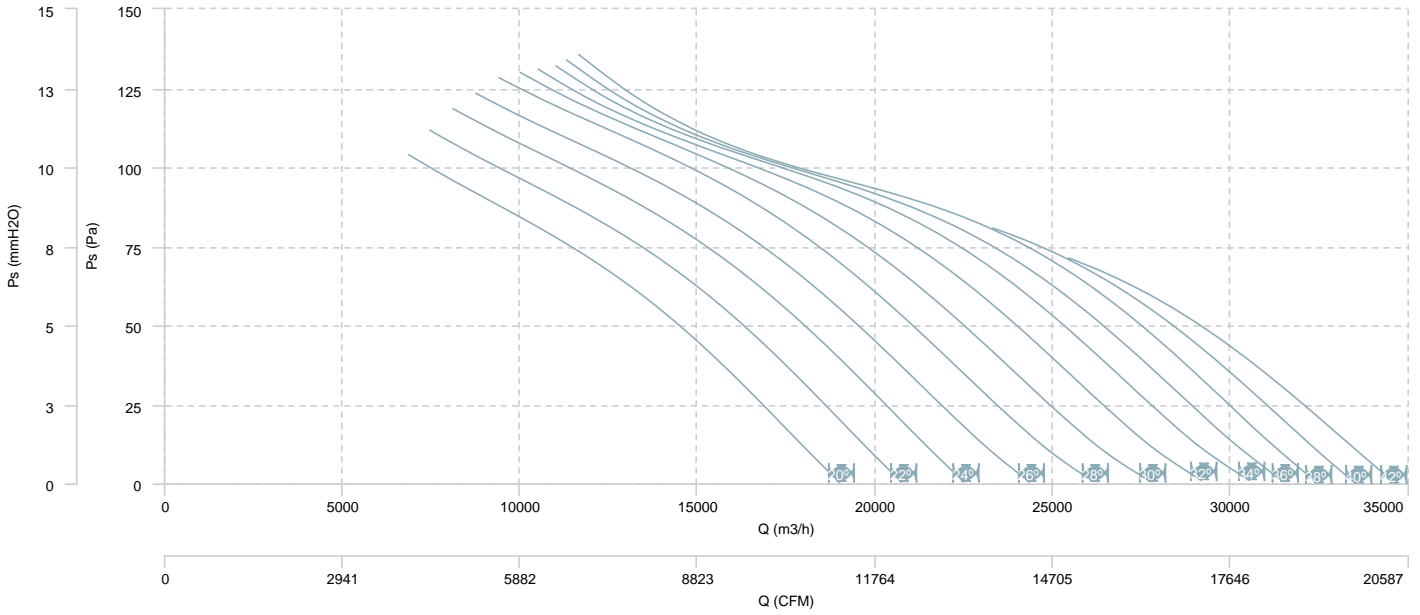

AIR FLOW - MECHANICAL POWER (8 poles)

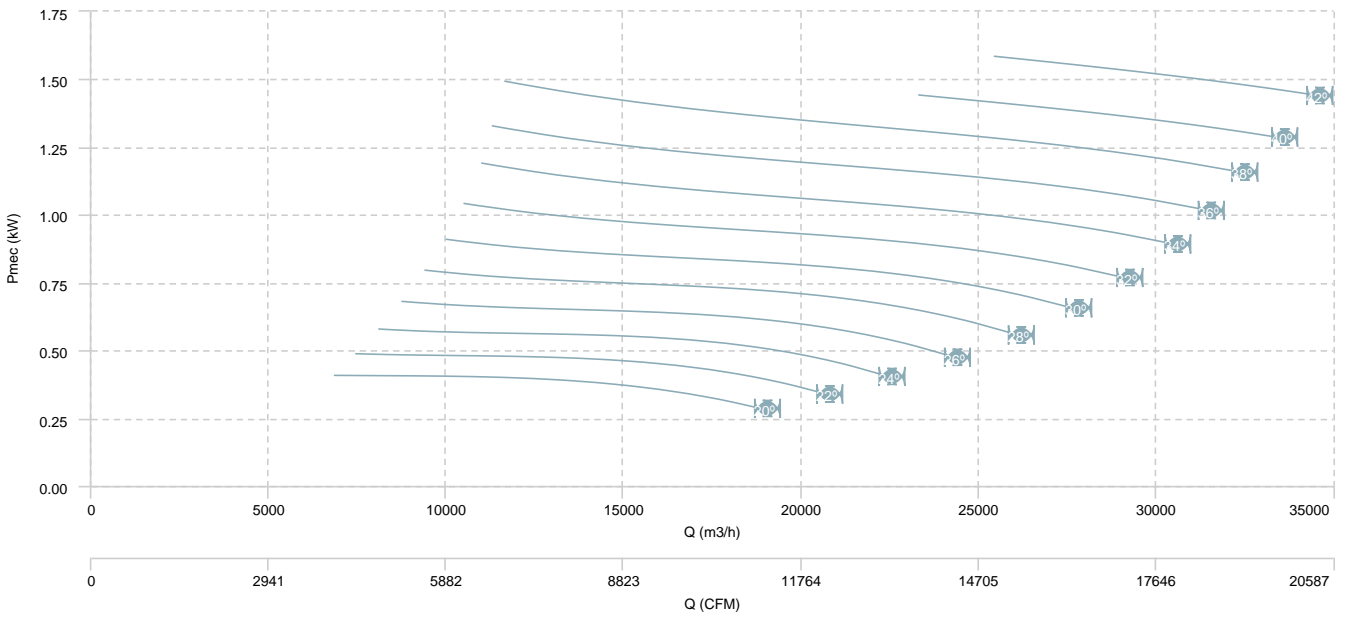

HC 100 T4/T8 (A6:6)

AIR FLOW - PRESSURE (4 poles)

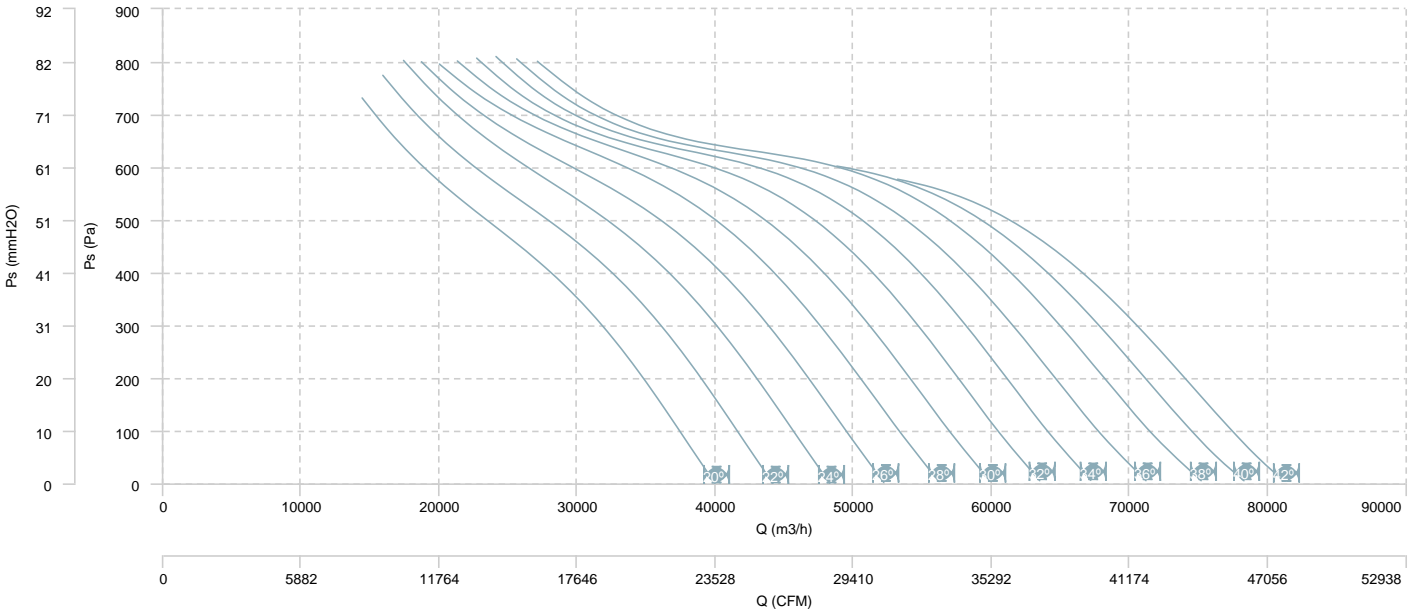

AIR FLOW - MECHANICAL POWER (4 poles)

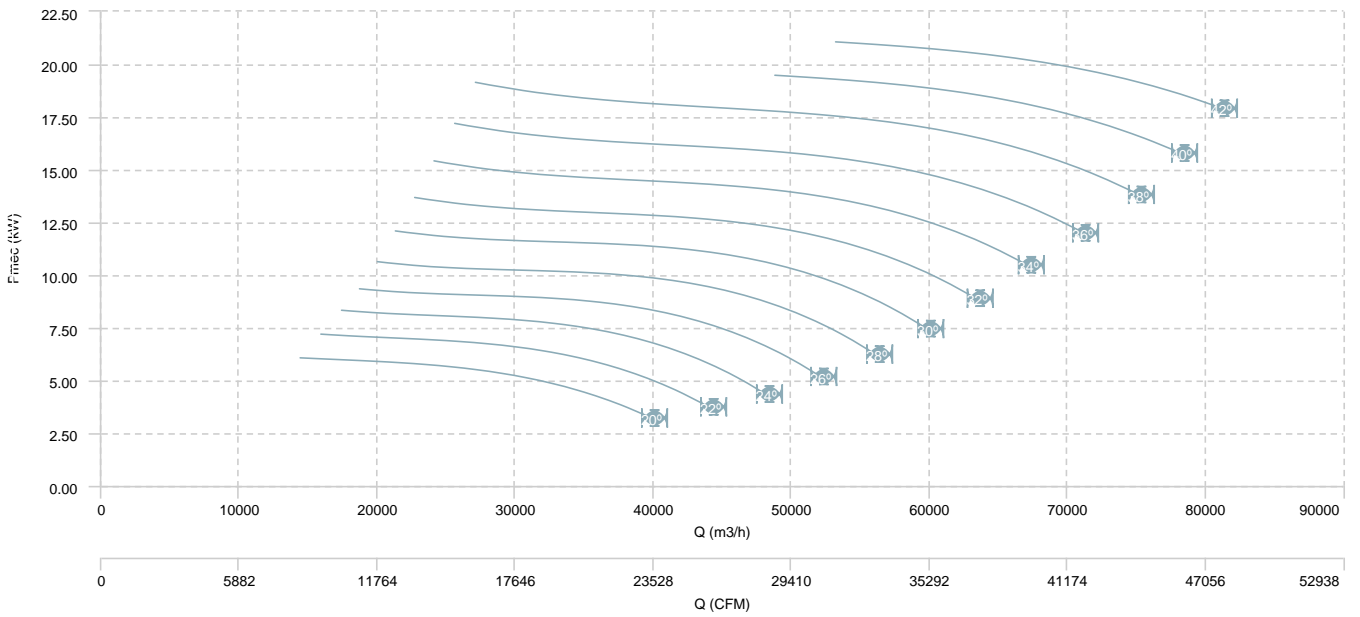

HC 100 T4/T8 (A6:6)

AIR FLOW - PRESSURE (8 poles)

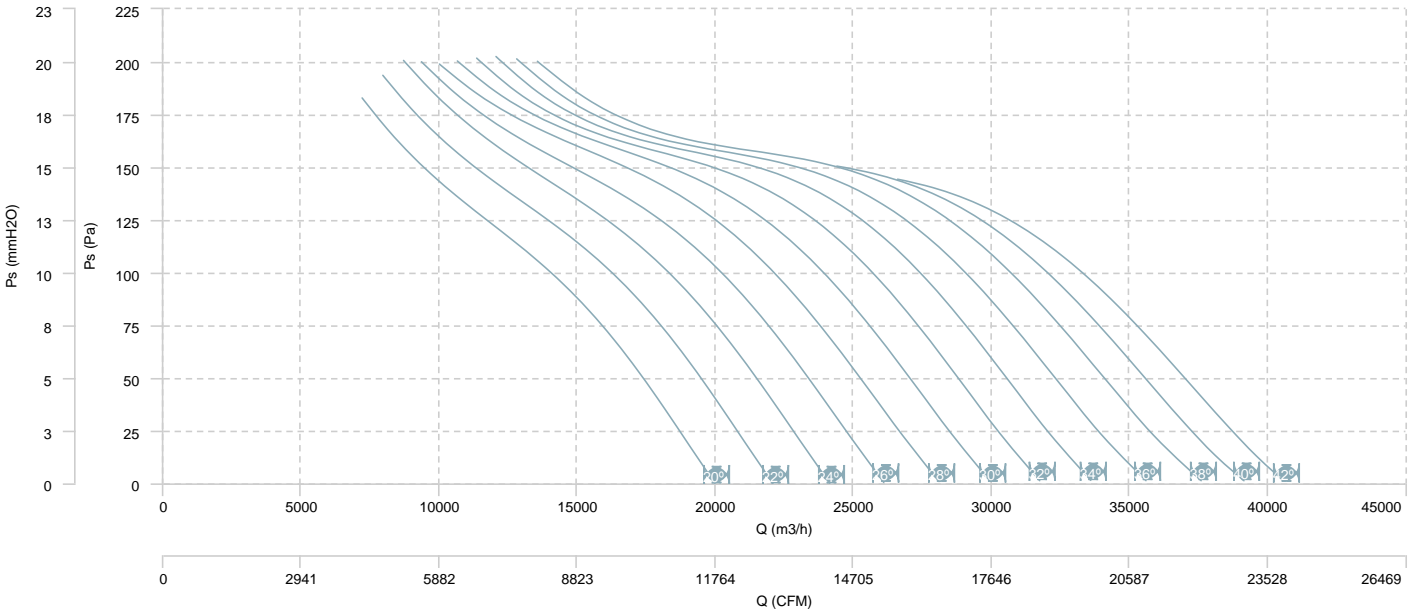

AIR FLOW - MECHANICAL POWER (8 poles)

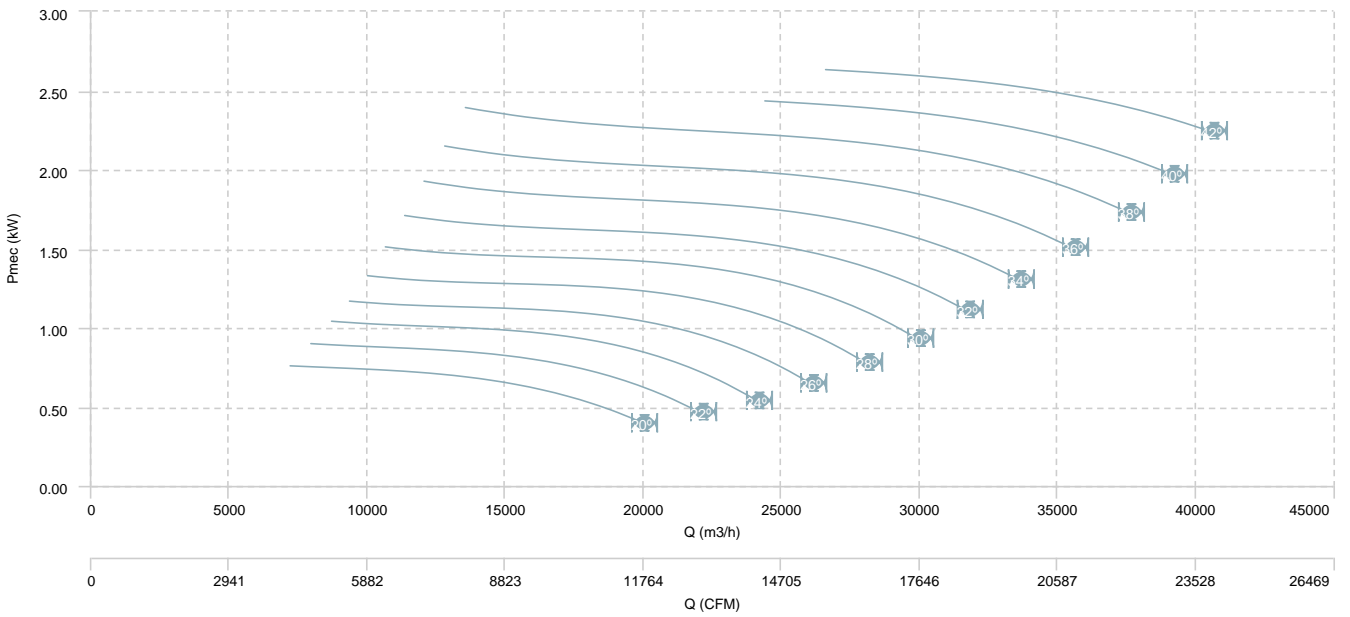

HC 112 T4 (A6:3)

AIR FLOW - PRESSURE

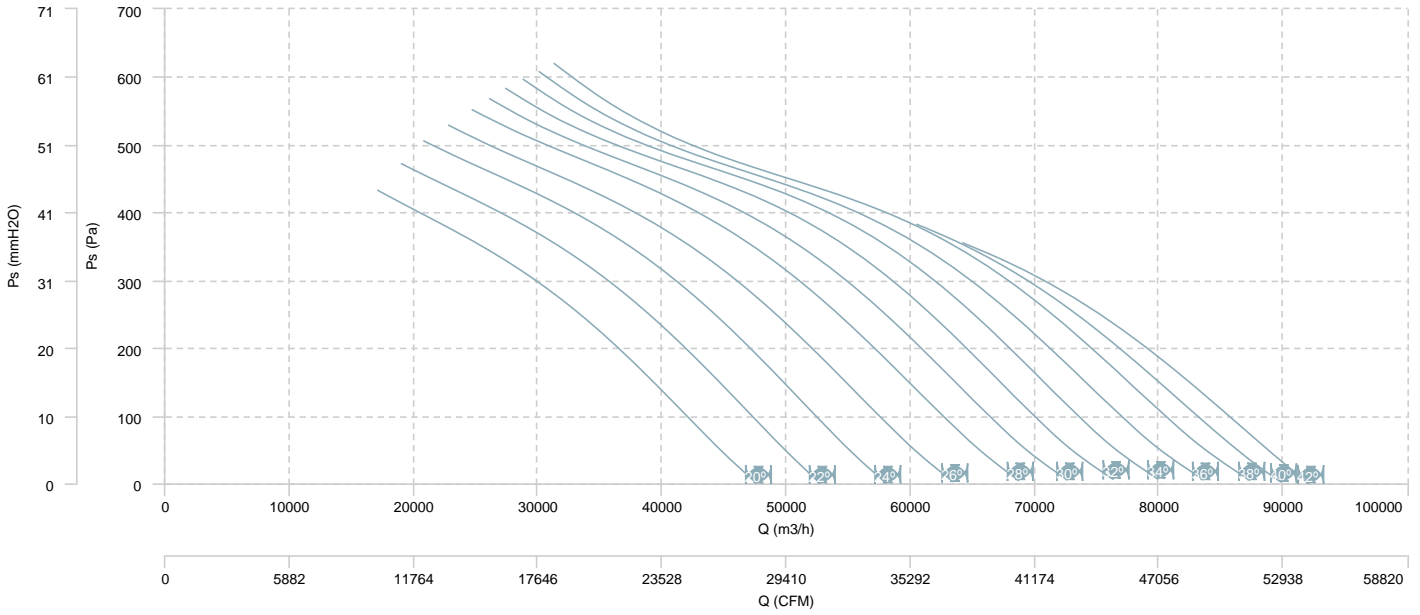

AIR FLOW - MECHANICAL POWER

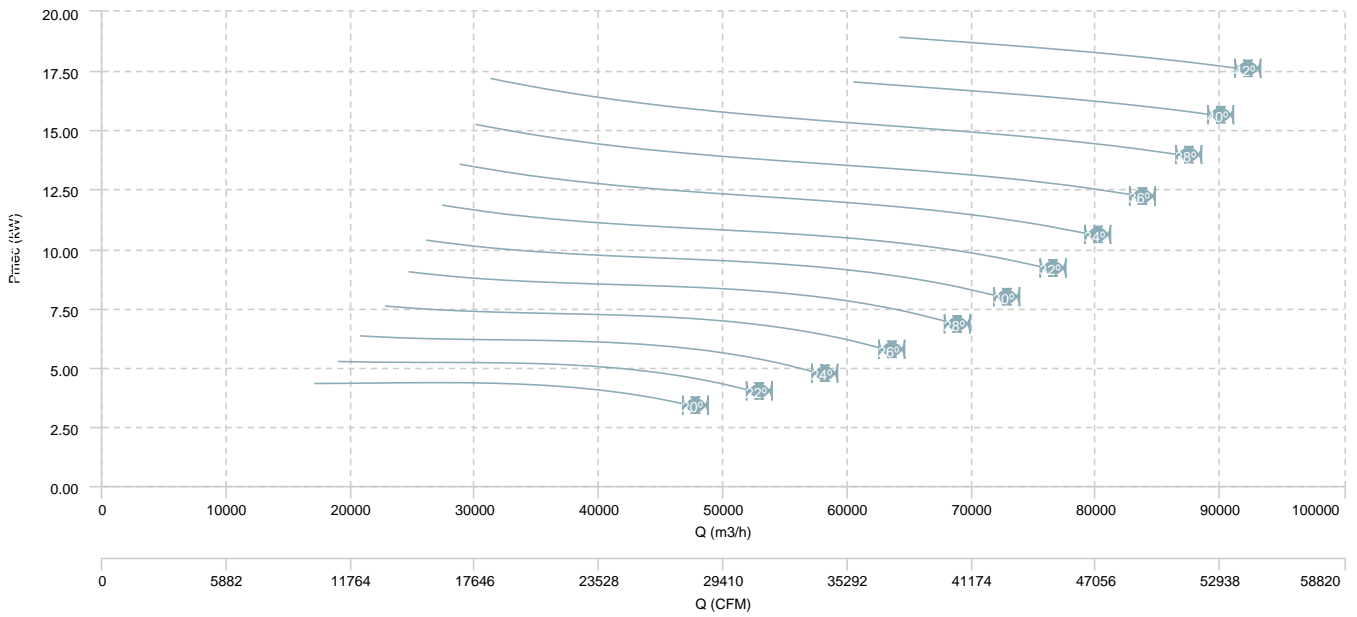

HC 112 T4 (A6:6)

AIR FLOW - PRESSURE

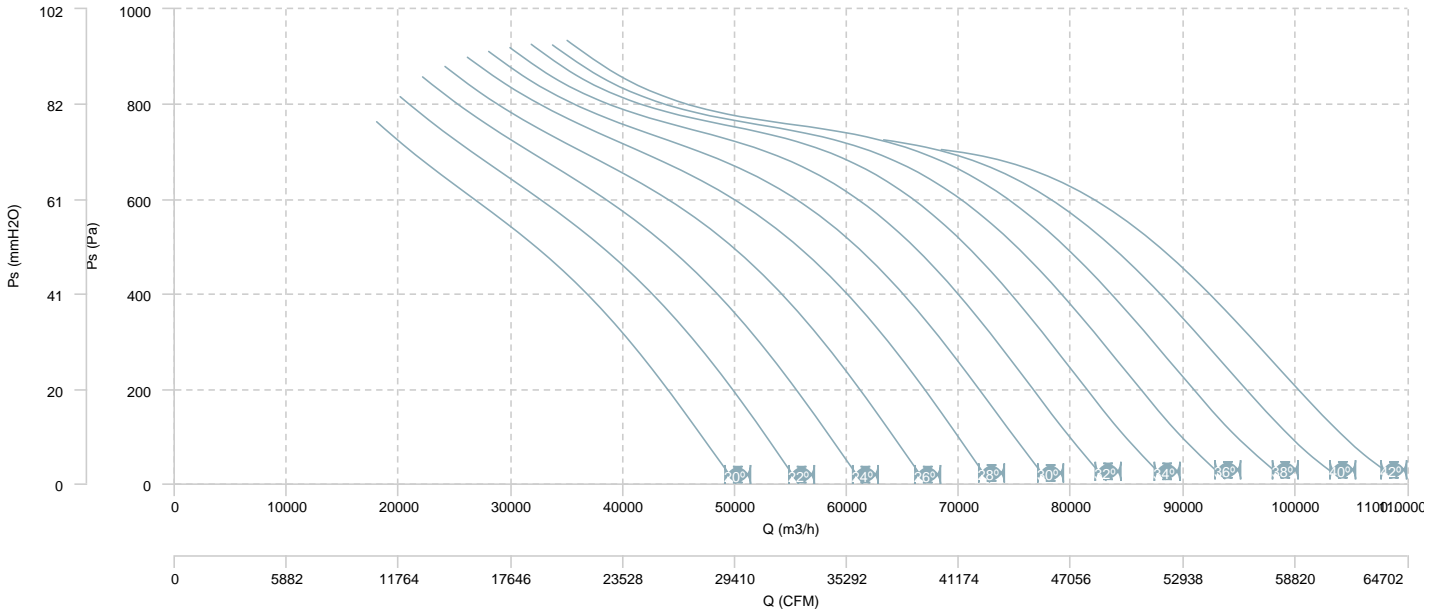

AIR FLOW - MECHANICAL POWER

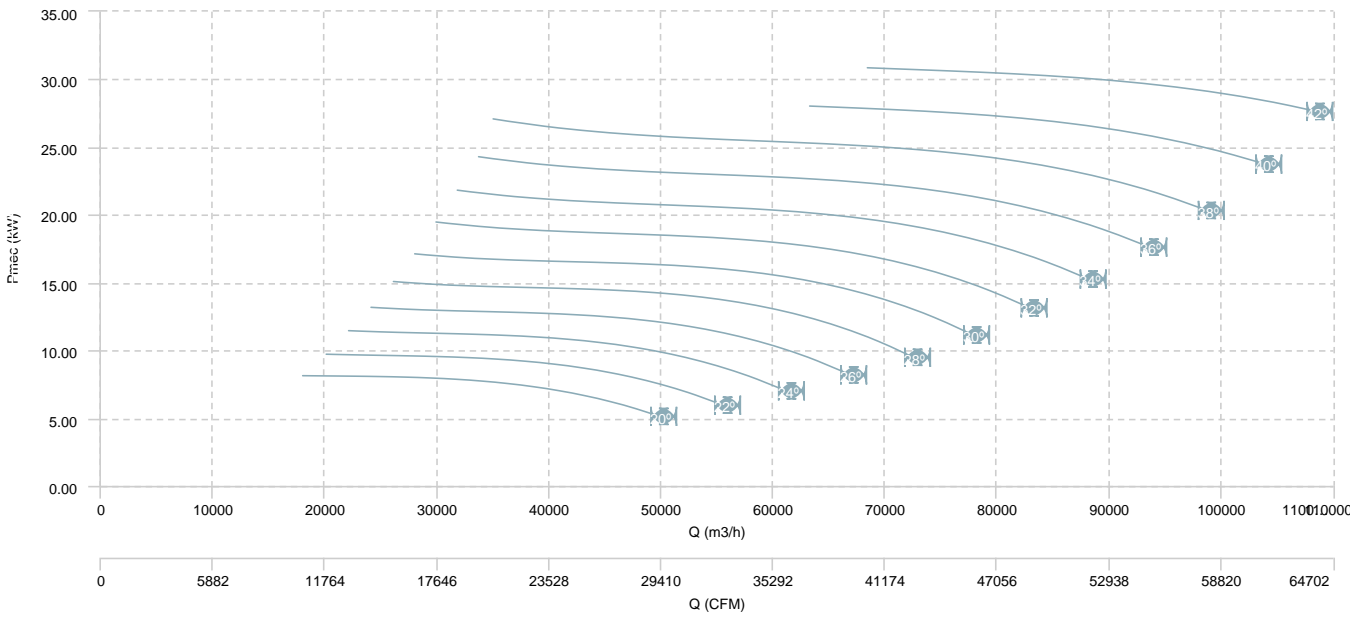

HC 112 T6 (A6:3)

AIR FLOW - PRESSURE

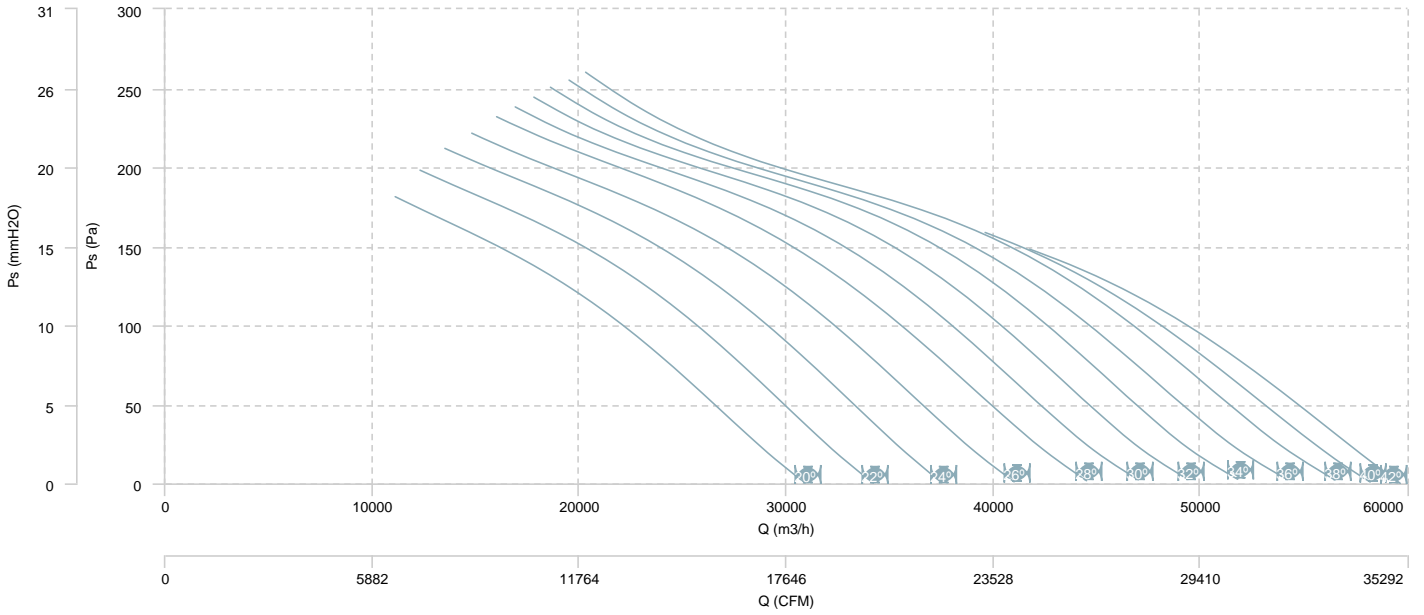

AIR FLOW - MECHANICAL POWER

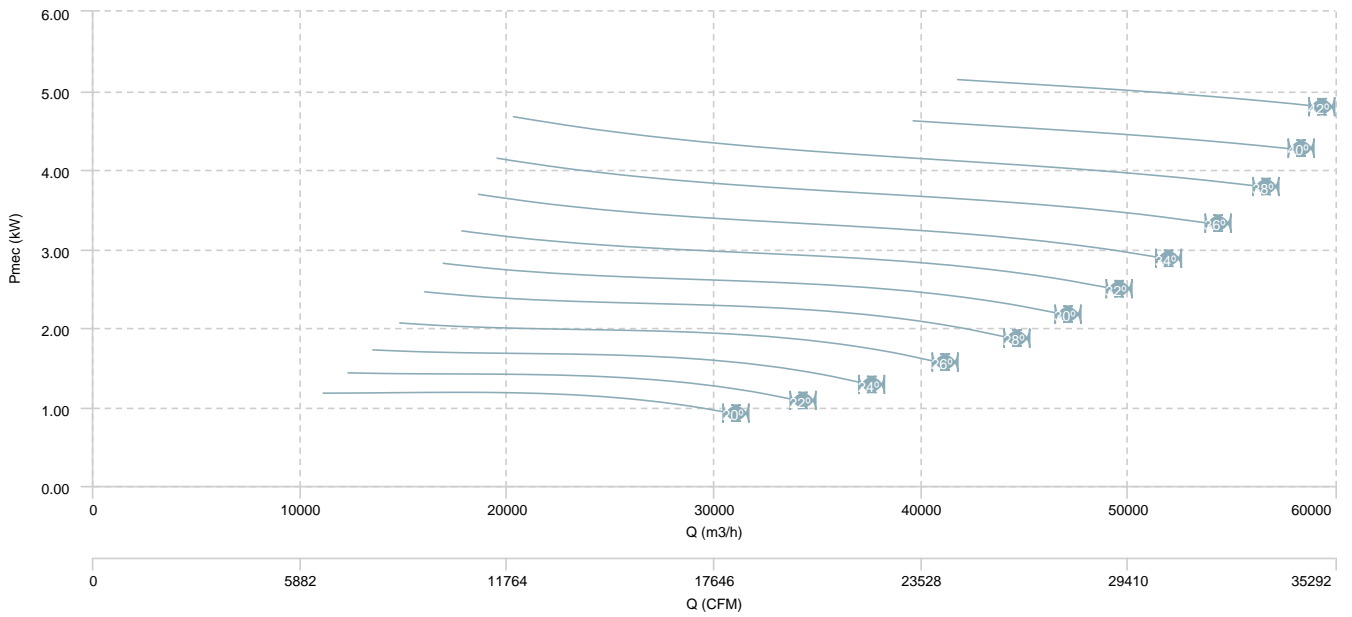

HC 112 T6 (A6:6)

AIR FLOW - PRESSURE

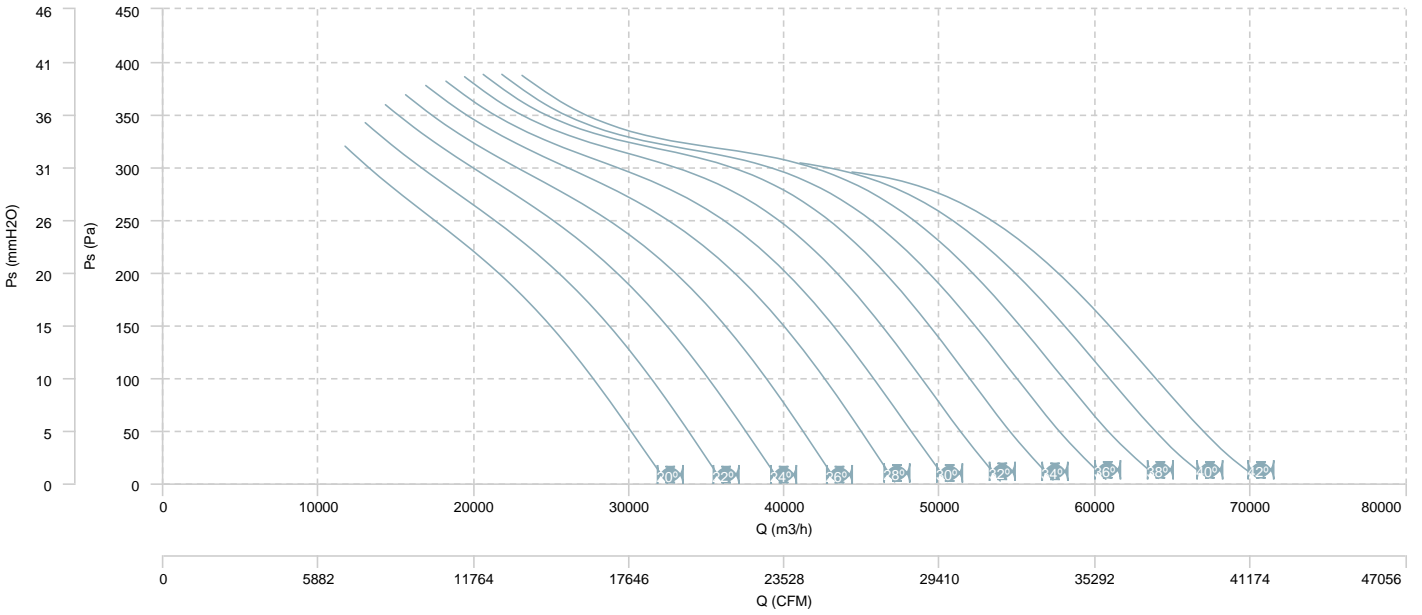

AIR FLOW - MECHANICAL POWER

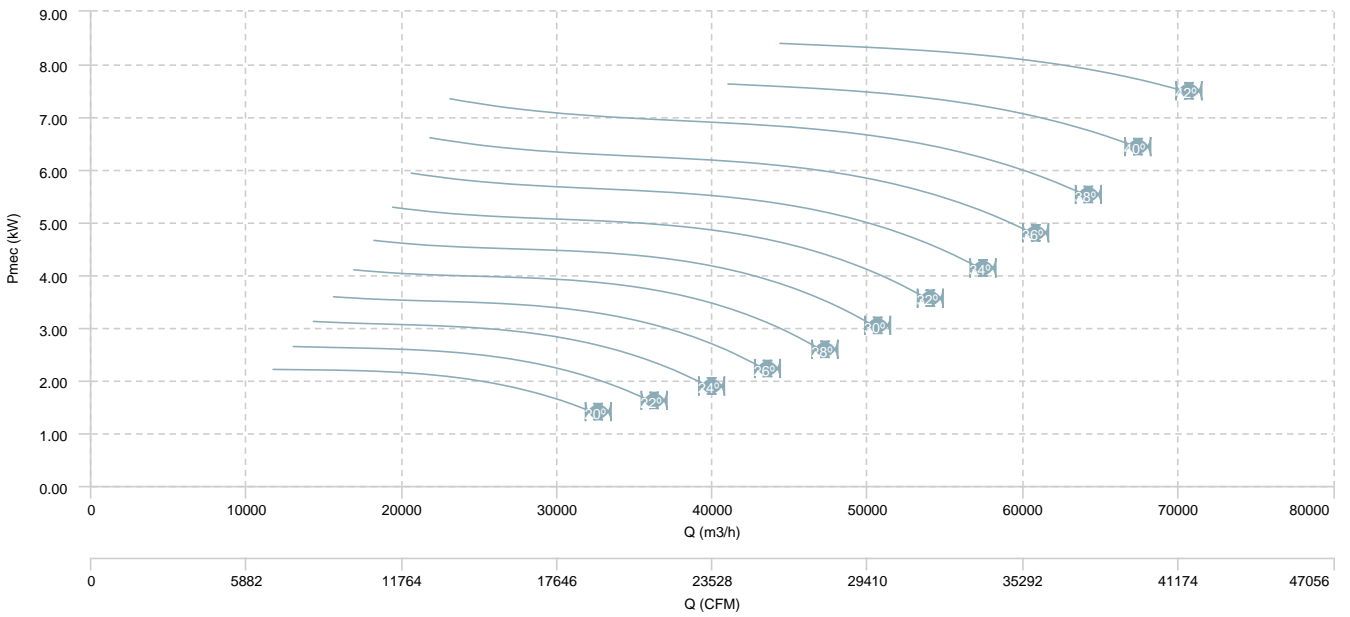

HC 112 T4/T8 (A6:3)

AIR FLOW - PRESSURE (4 poles)

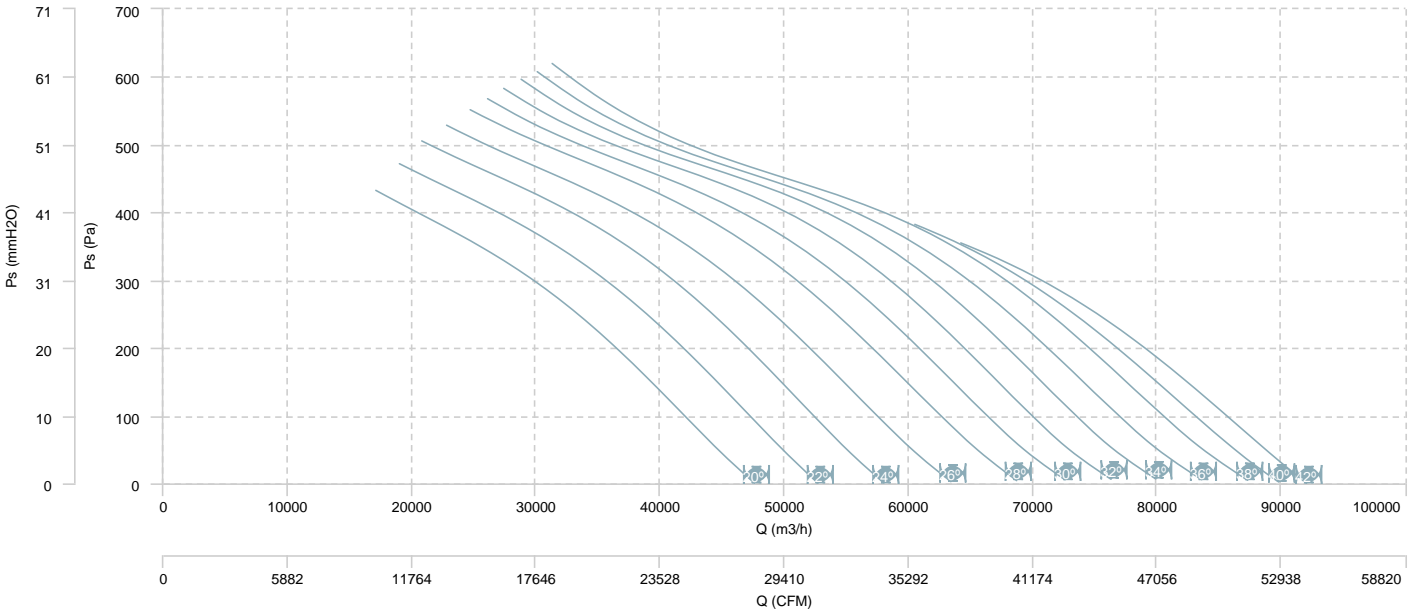

AIR FLOW - MECHANICAL POWER (4 poles)

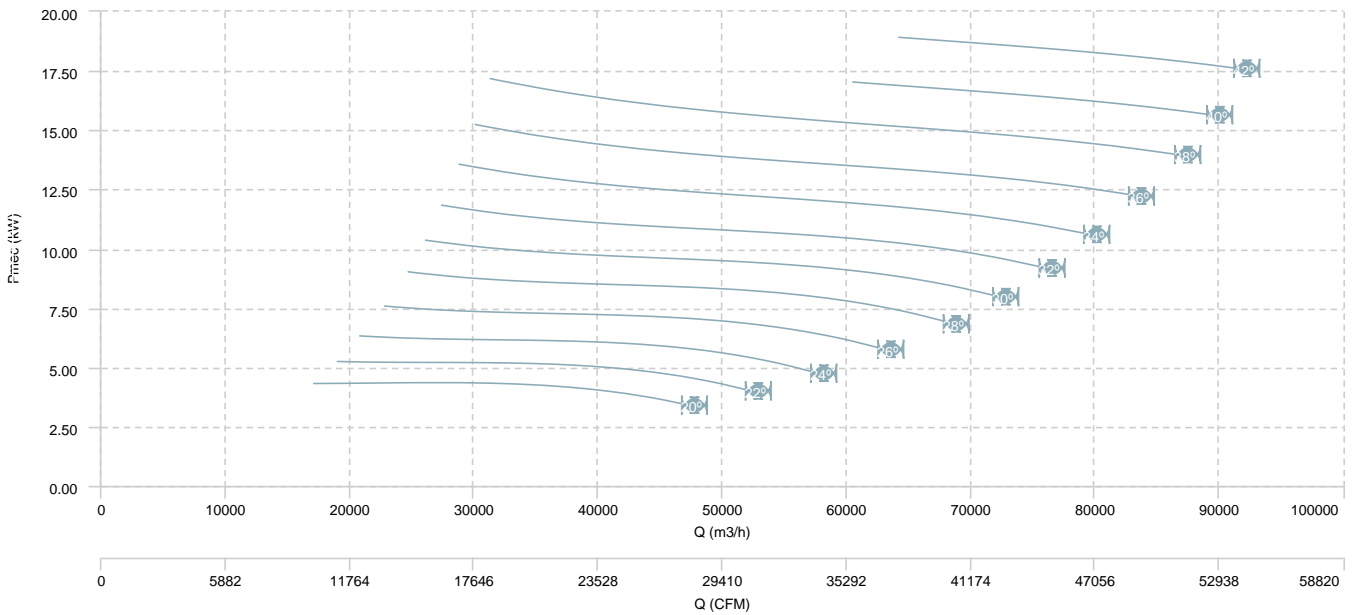

HC 112 T4/T8 (A6:3)

AIR FLOW - PRESSURE (8 poles)

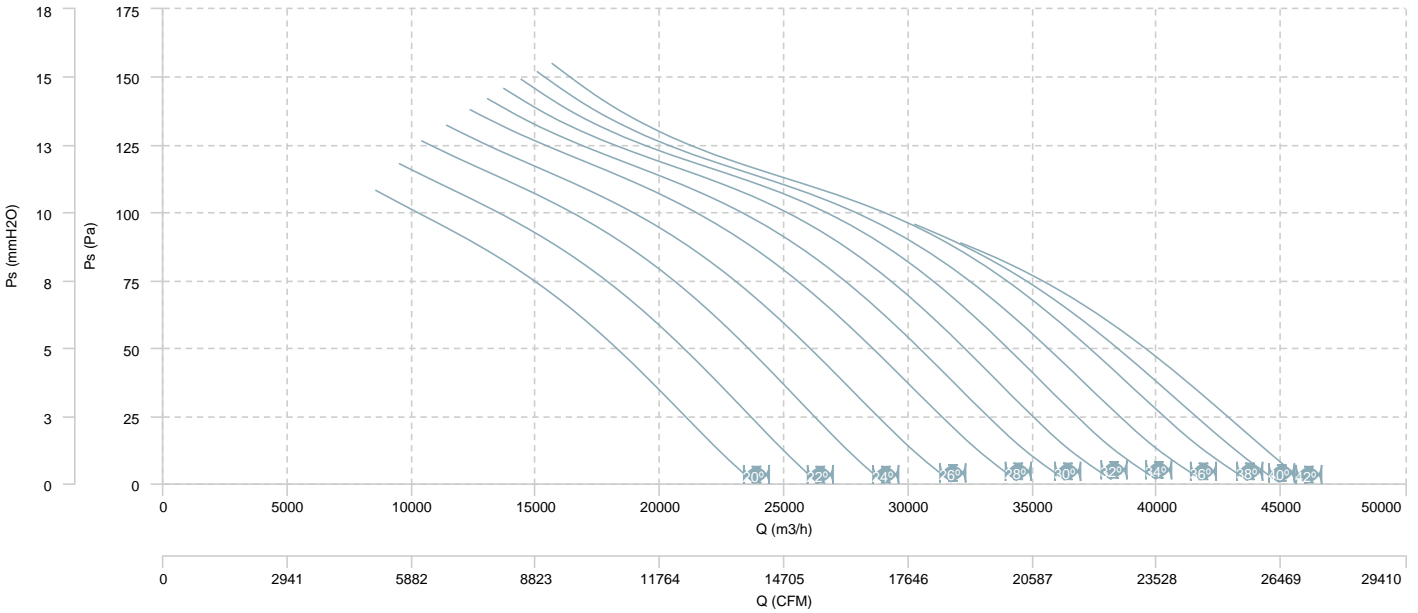

AIR FLOW - MECHANICAL POWER (8 poles)

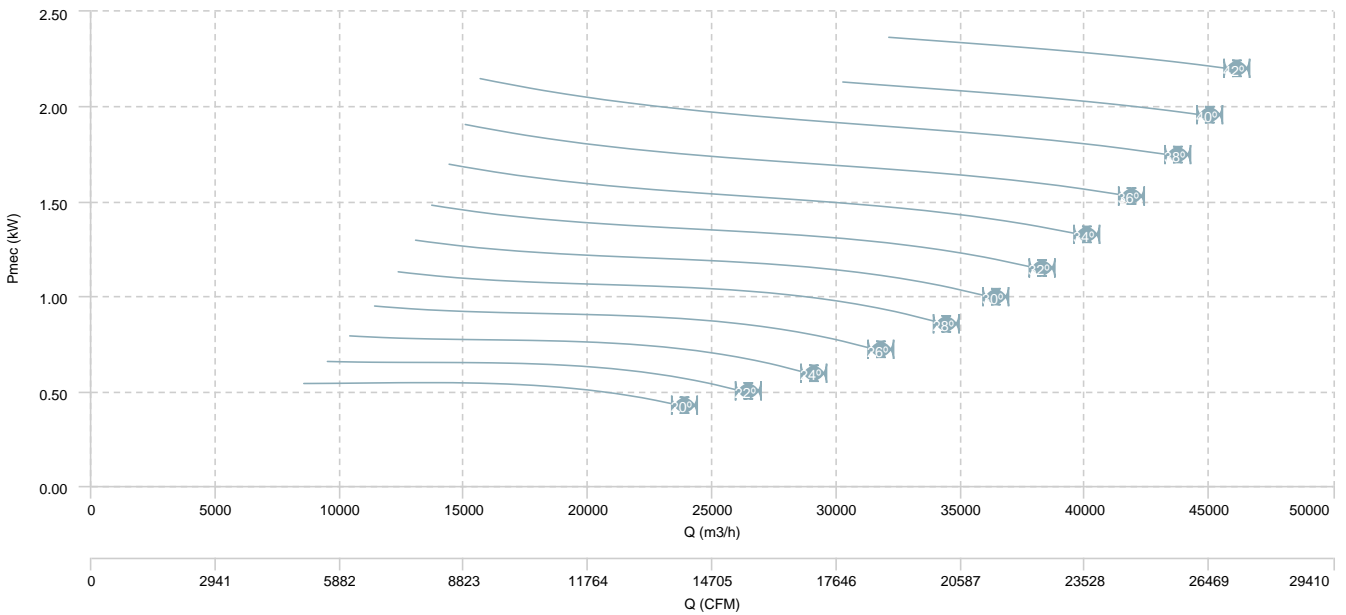

HC 112 T4/T8 (A6:6)

AIR FLOW - PRESSURE (4 poles)

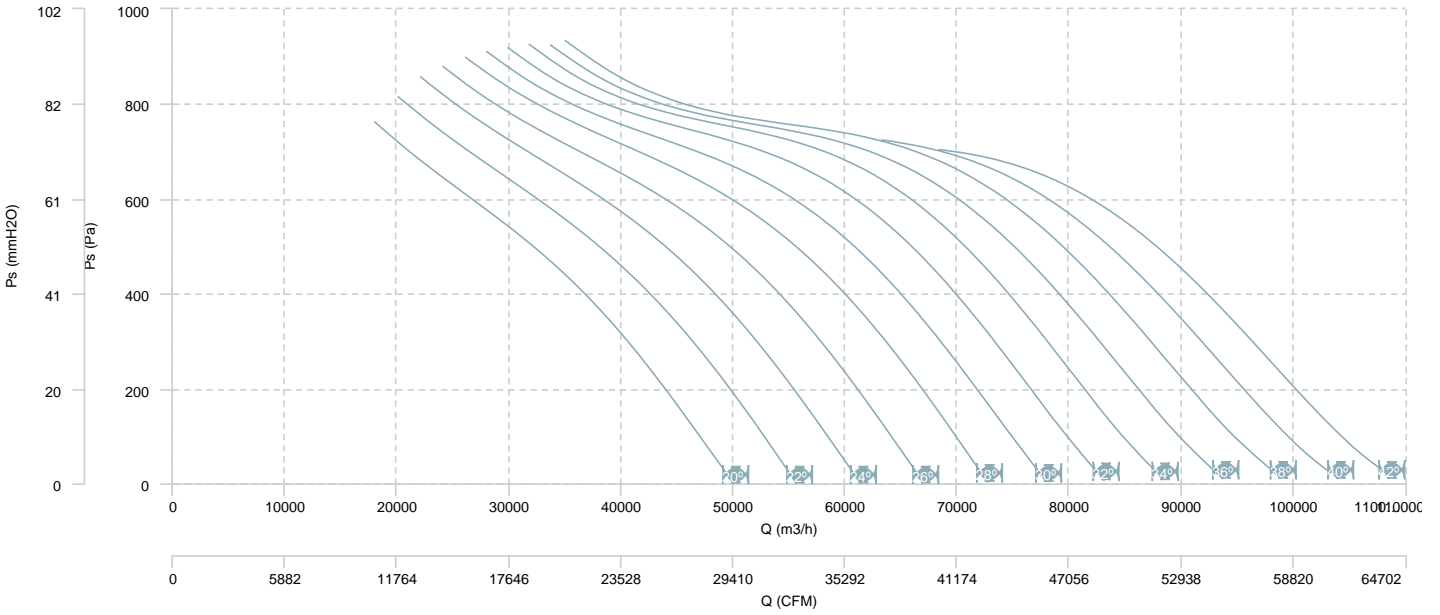

AIR FLOW - MECHANICAL POWER (4 poles)

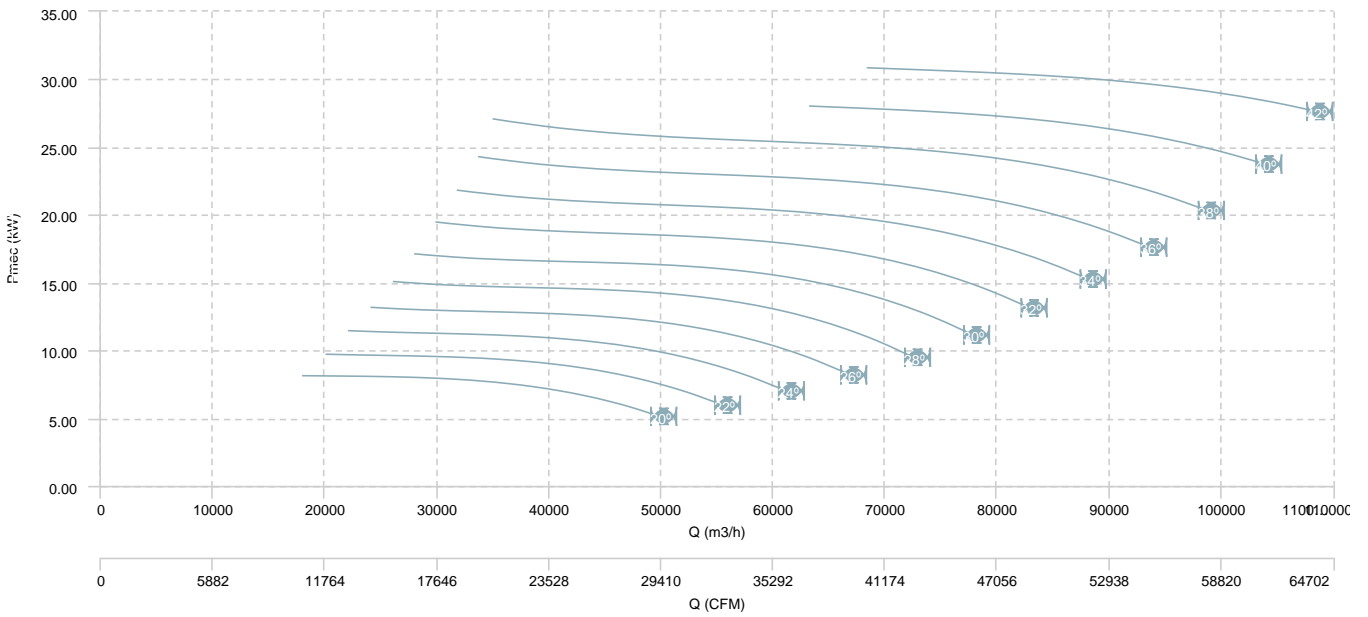

HC 112 T4/T8 (A6:6)

AIR FLOW - PRESSURE (8 poles)

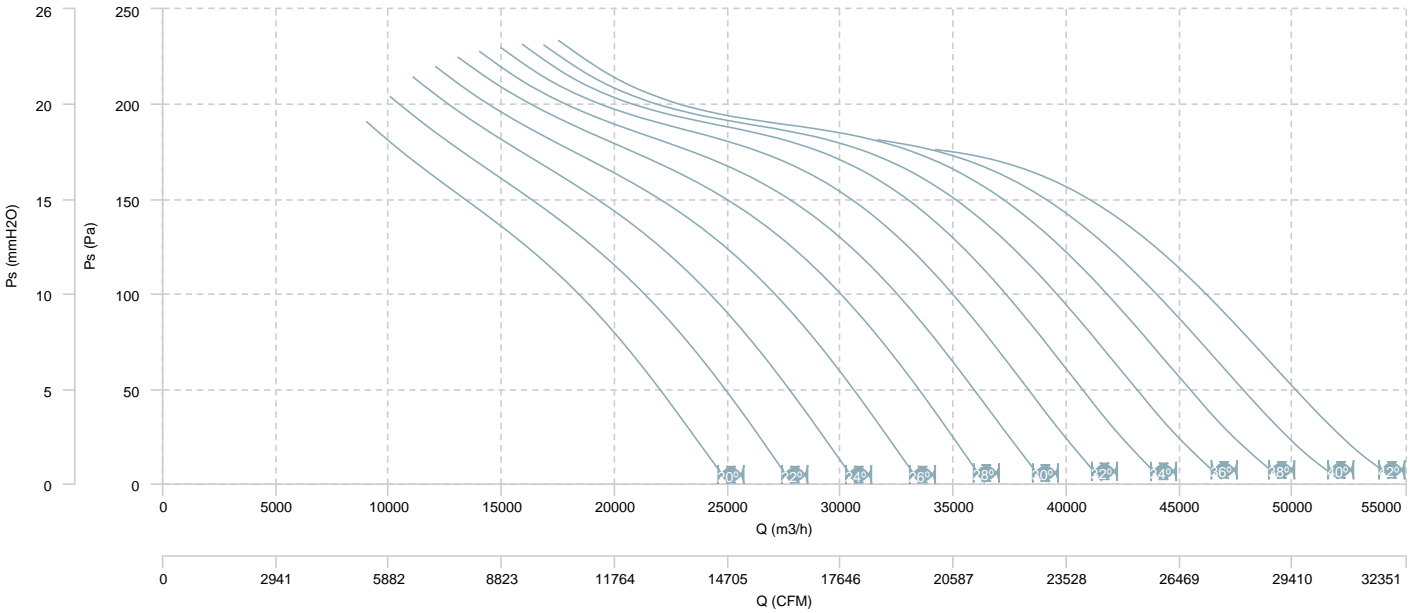

AIR FLOW - MECHANICAL POWER (8 poles)

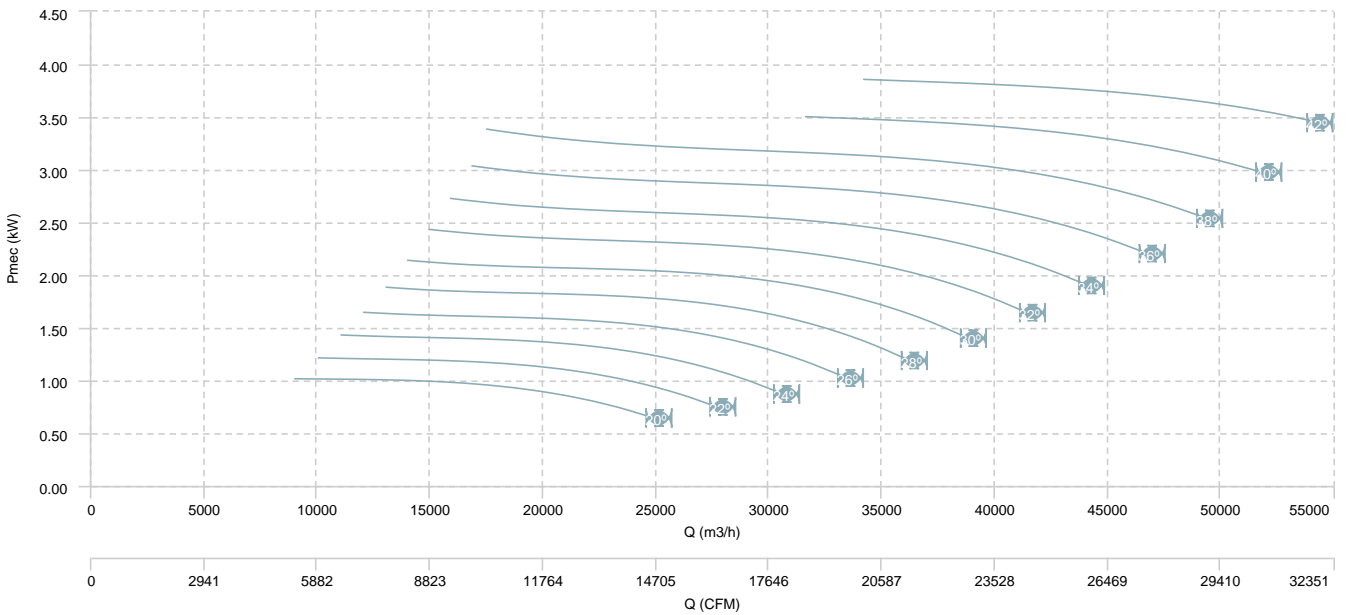

HC 125 T4 (A7:4)

AIR FLOW - PRESSURE

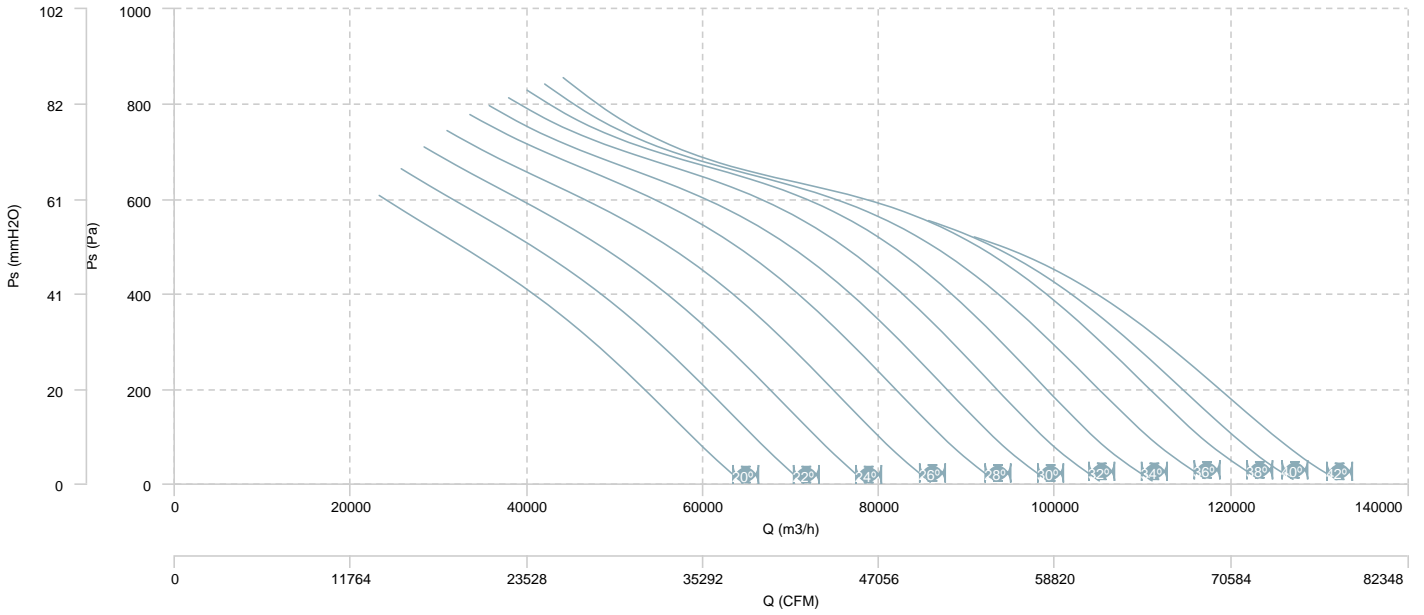

AIR FLOW - MECHANICAL POWER

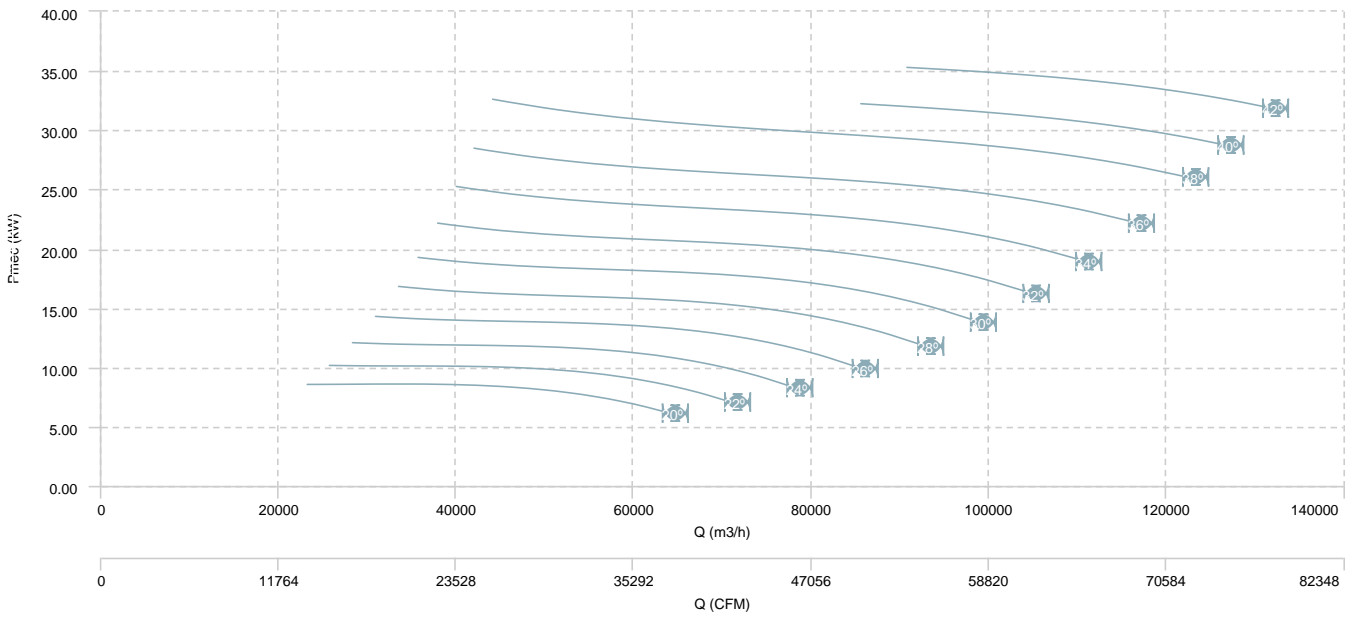

HC 125 T4 (A7:8)

AIR FLOW - PRESSURE

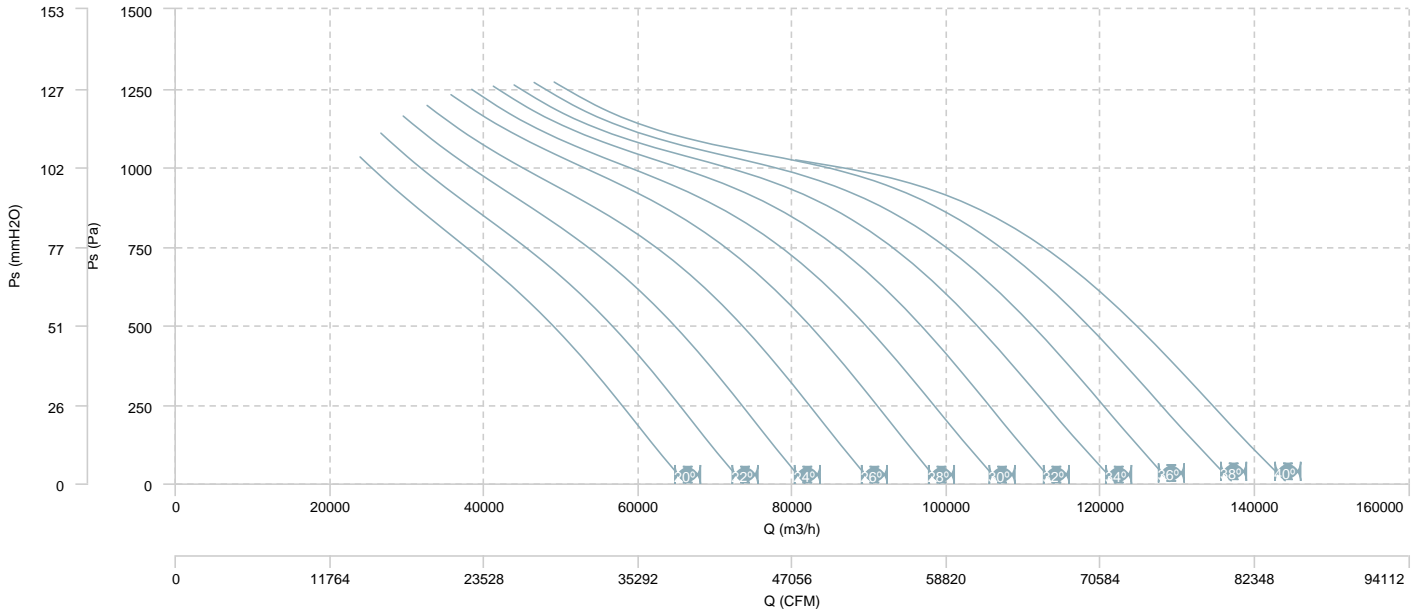

AIR FLOW - MECHANICAL POWER

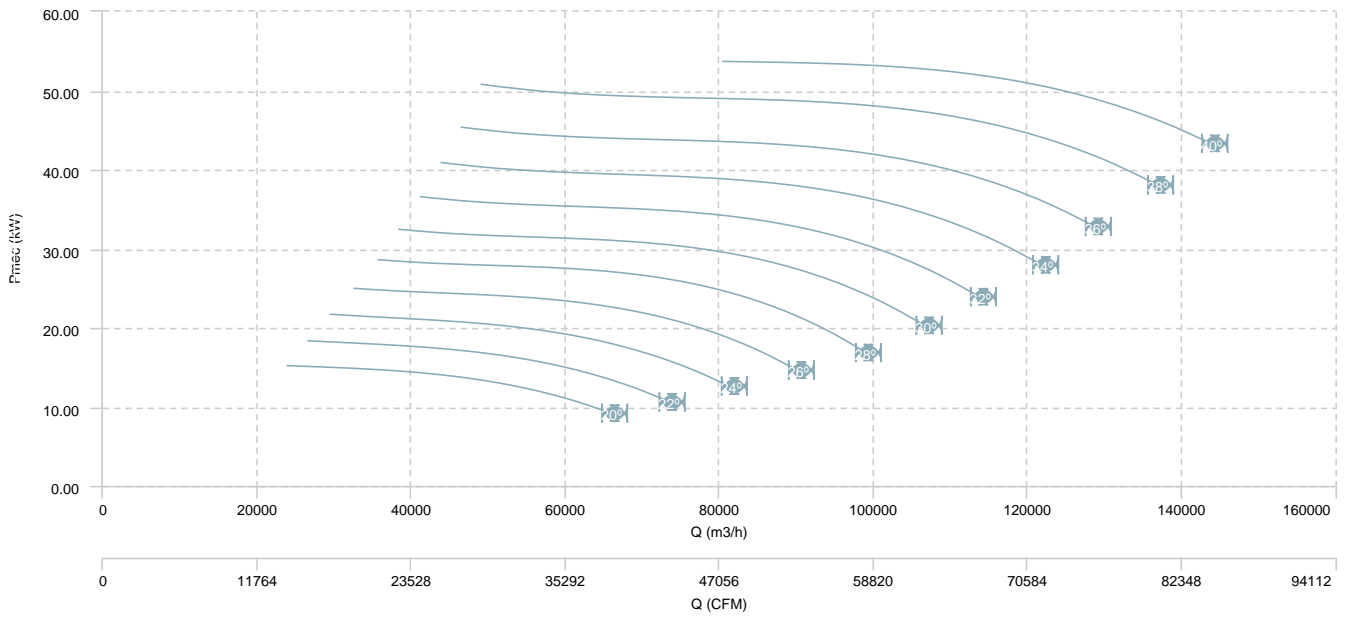

HC 125 T6 (A7:4)

AIR FLOW - PRESSURE

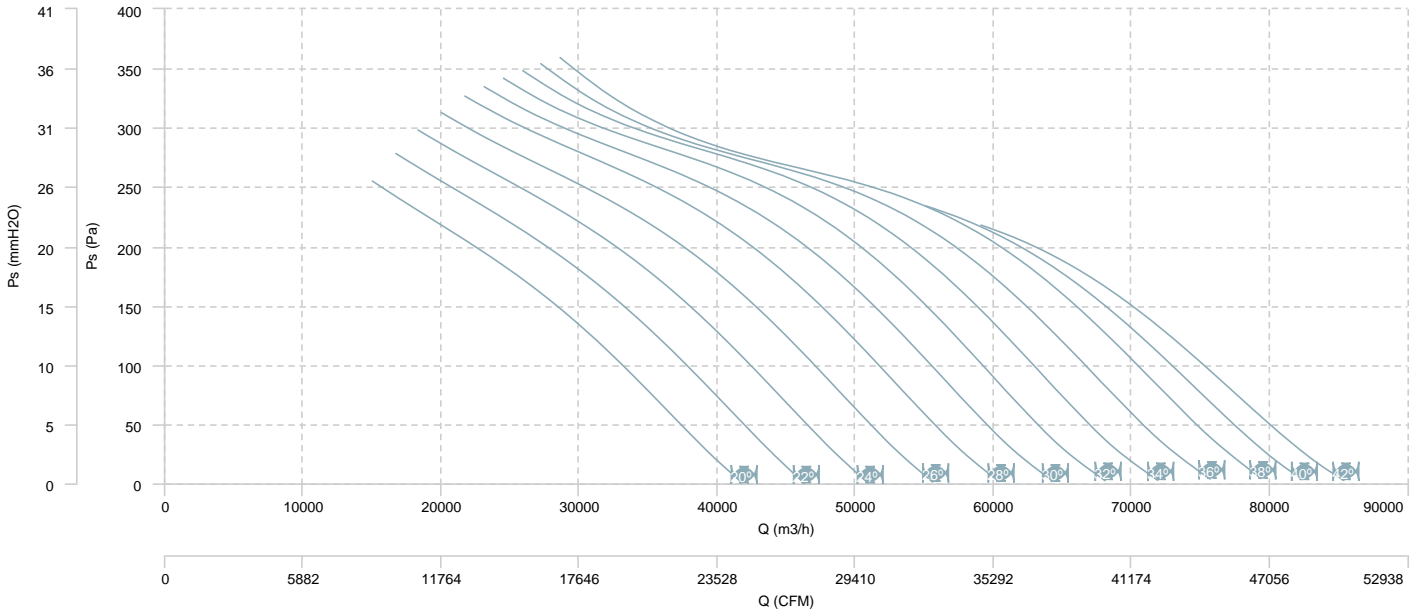

AIR FLOW - MECHANICAL POWER

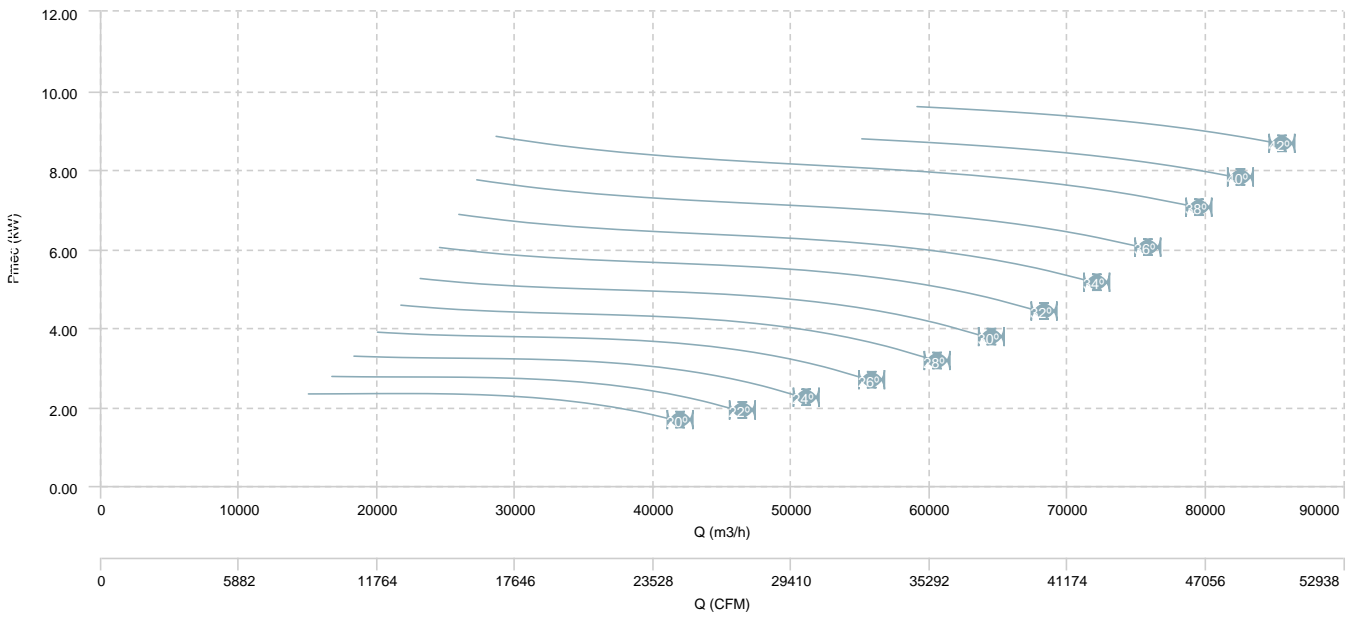

HC 125 T6 (A7:8)

AIR FLOW - PRESSURE

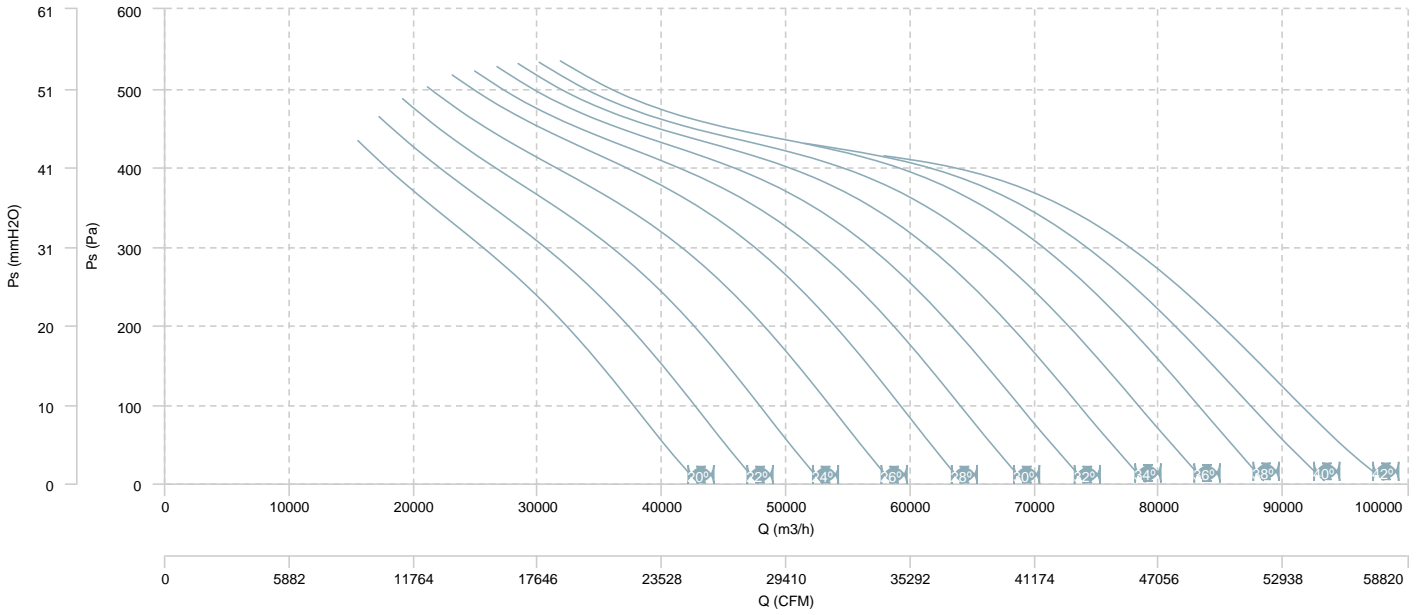

AIR FLOW - MECHANICAL POWER

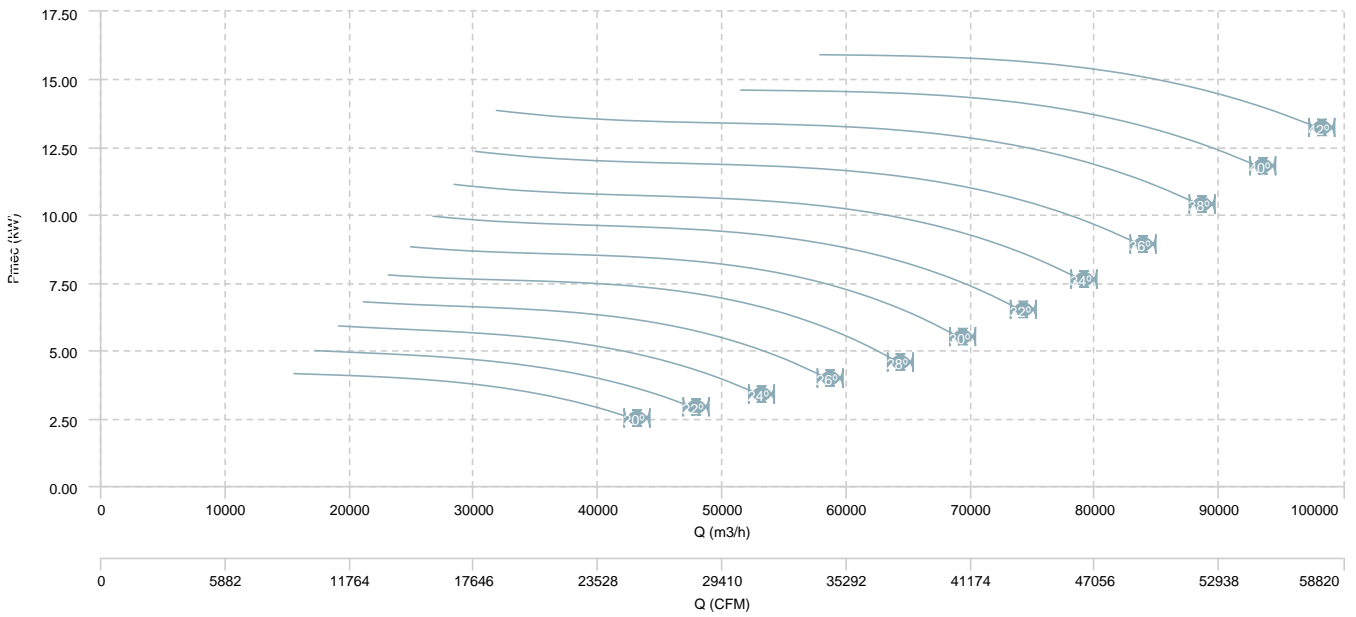

HC 125 T4/T8 (A7:4)

AIR FLOW - PRESSURE (4 poles)

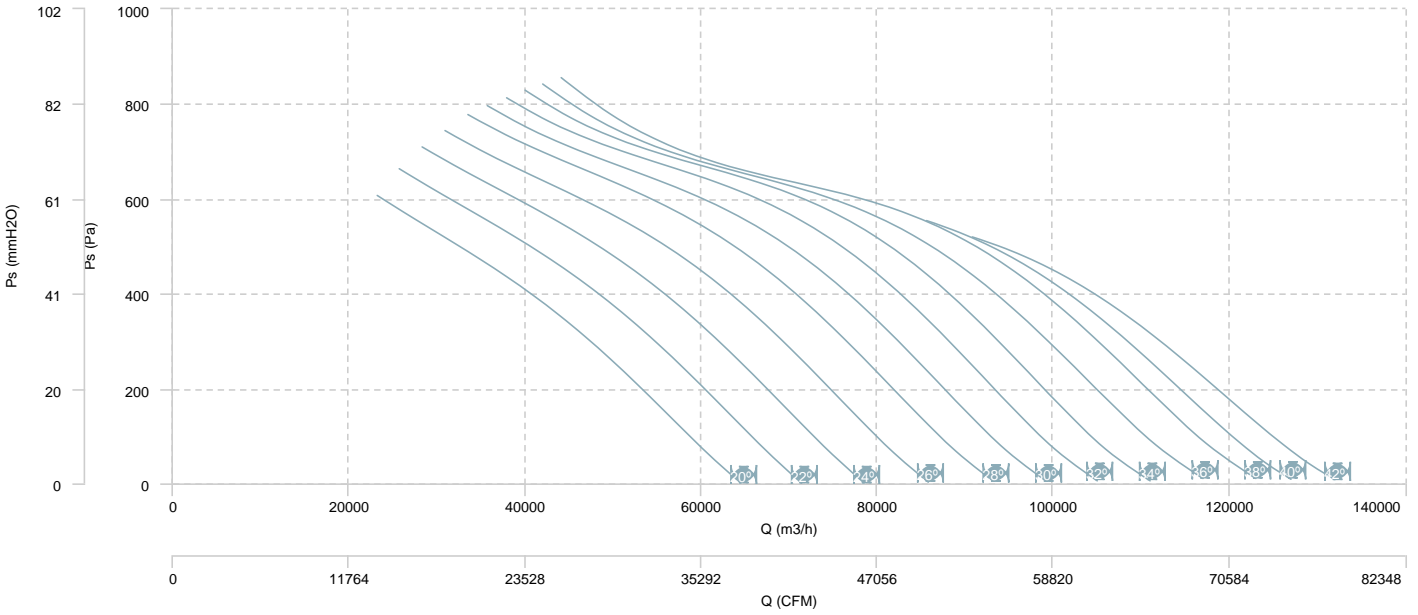

AIR FLOW - MECHANICAL POWER (4 poles)

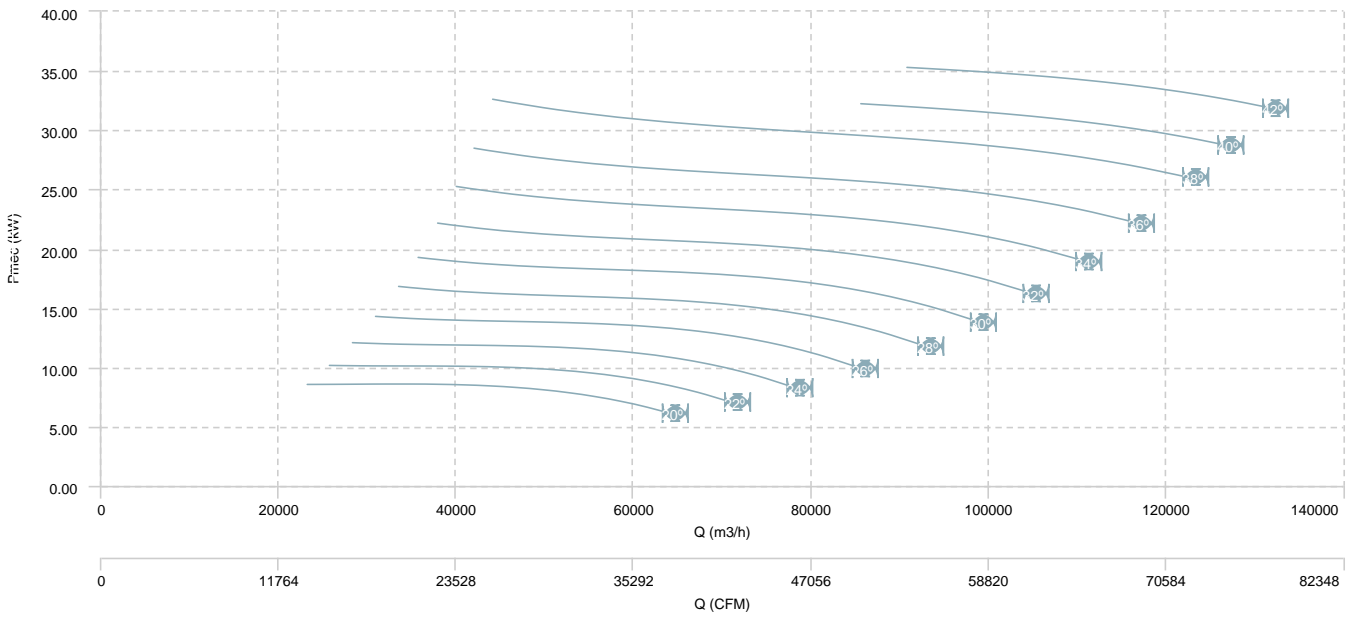

HC 125 T4/T8 (A7:4)

AIR FLOW - PRESSURE (8 poles)

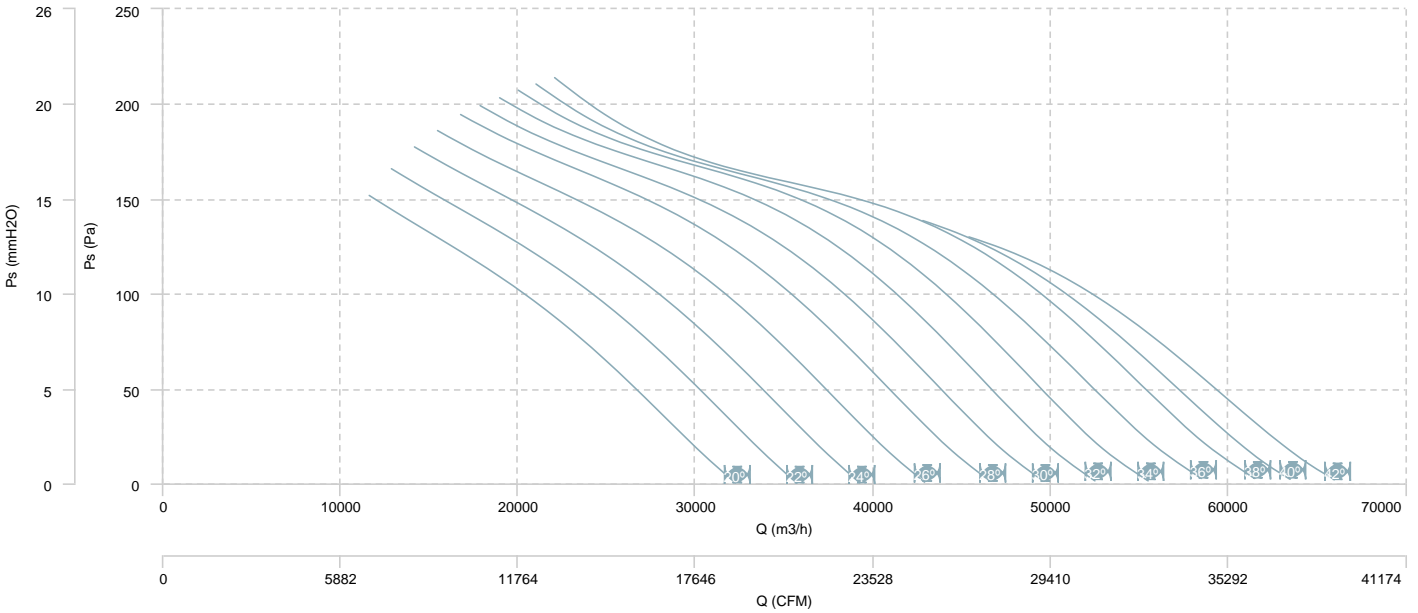

AIR FLOW - MECHANICAL POWER (8 poles)

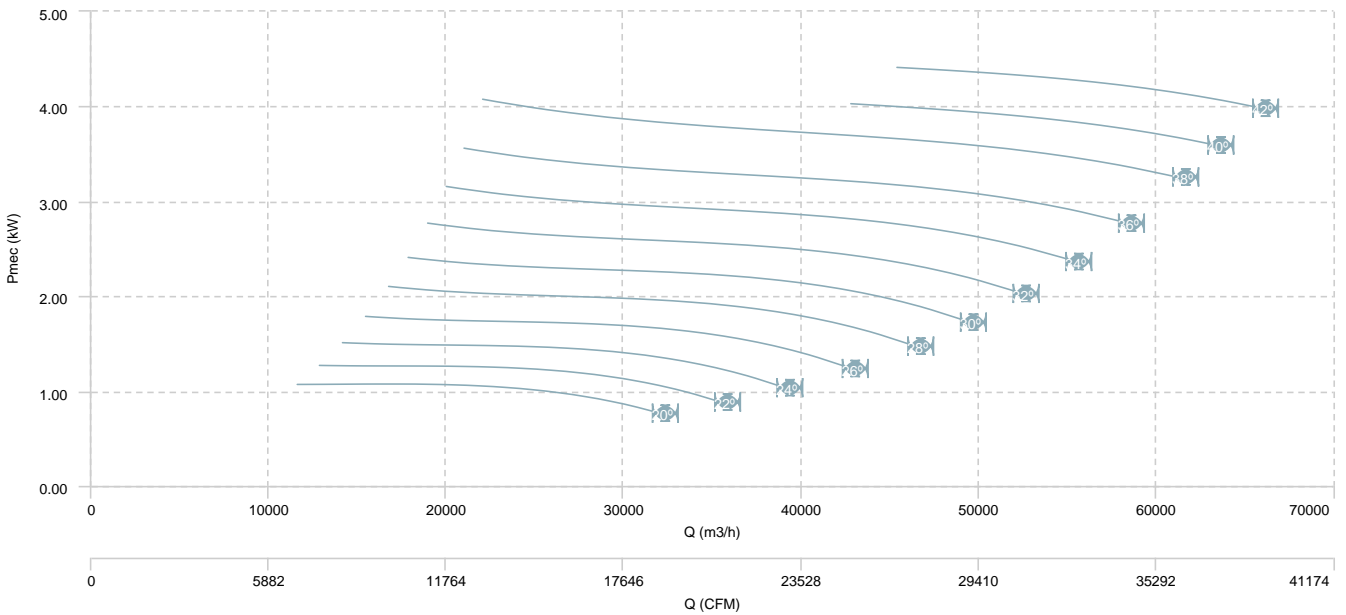

HC 125 T4/T8 (A7:8)

AIR FLOW - PRESSURE (4 poles)

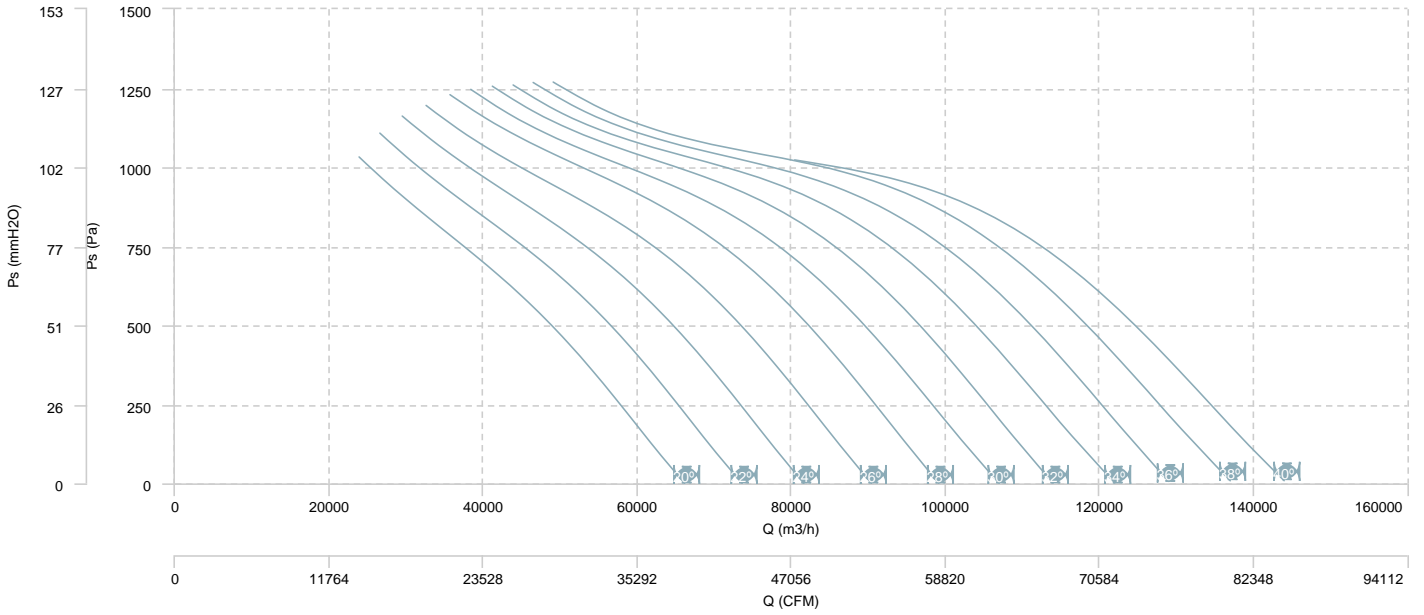

AIR FLOW - MECHANICAL POWER (4 poles)

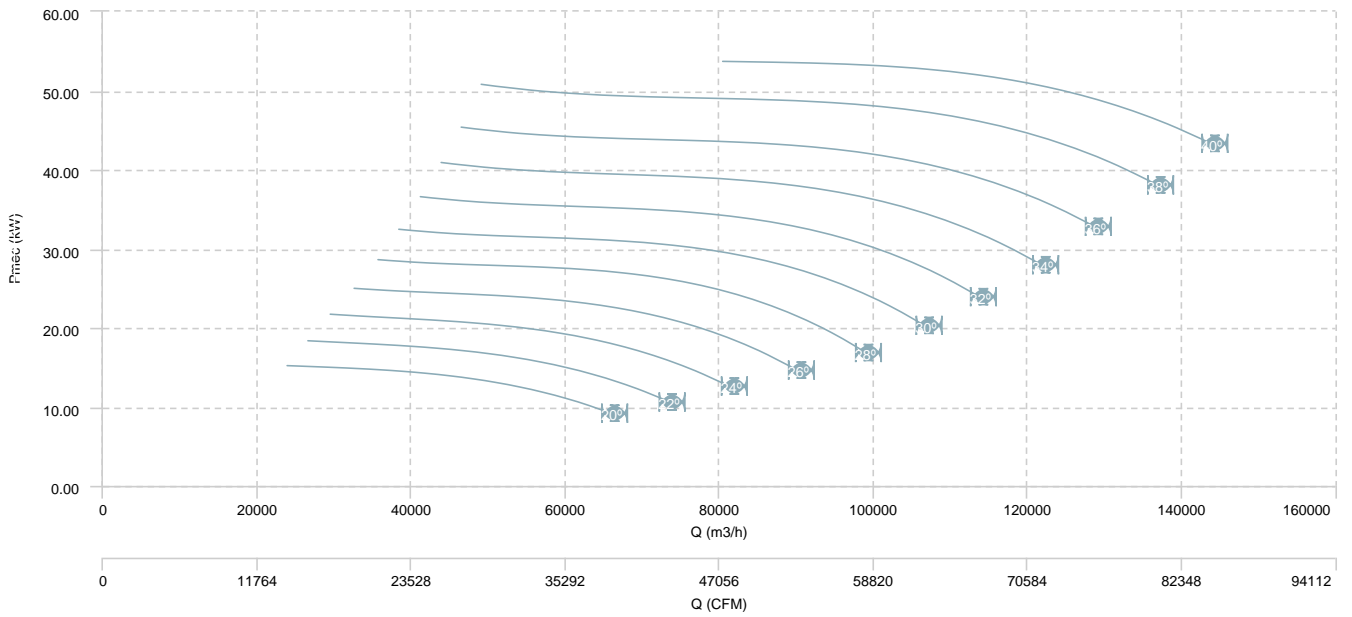

HC 125 T4/T8 (A7:8)

AIR FLOW - PRESSURE (8 poles)

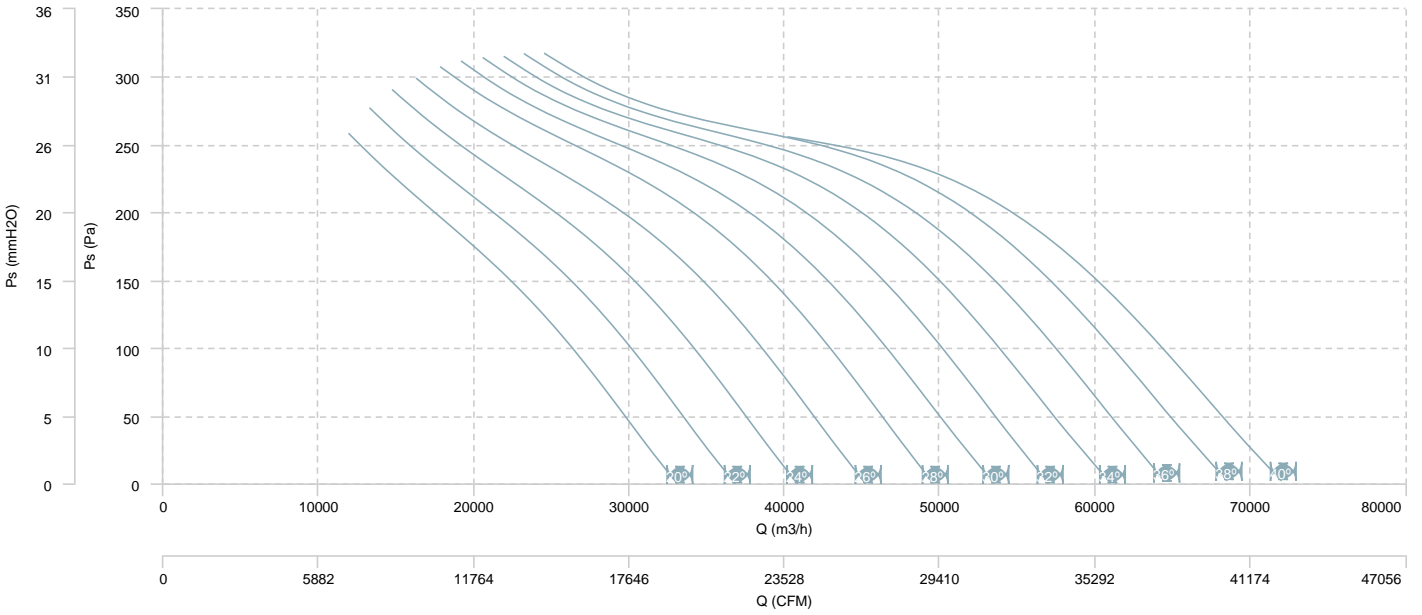

AIR FLOW - MECHANICAL POWER (8 poles)

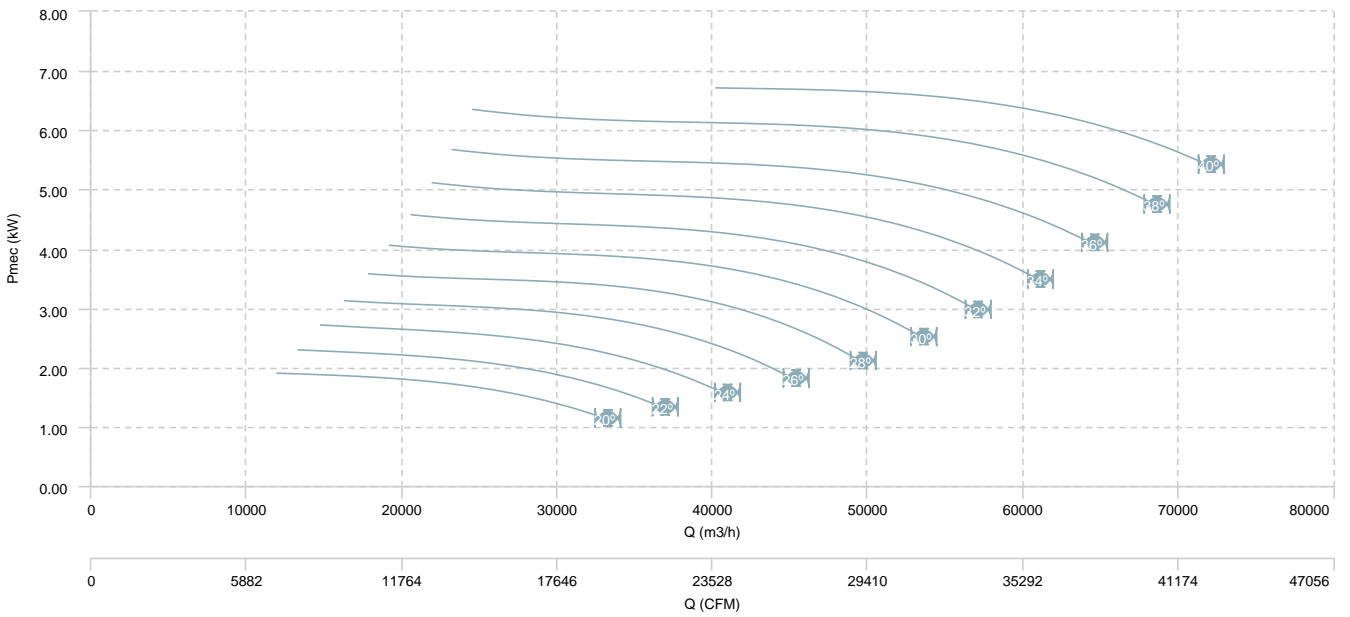

Sound data

Sound / 4 poles

Sound power Lw dB (A)										
Model		63 Hz	125 Hz	250 Hz	500 Hz	1000 Hz	2000 Hz	4000 Hz	8000 Hz	Total
HC 35 M4 (A0:6) (35º)	Inlet	65	63	62	60	60	59	61	57	71
HC 35 M4 (A0:6) (40º)	Inlet	67	65	64	62	61	61	62	58	72
HC 35 T4 (A0:6) (35º)	Inlet	65	63	62	60	60	59	61	57	71
HC 35 T4 (A0:6) (40º)	Inlet	67	65	64	62	61	61	62	58	72
HC 40 M4 (A0:6) (35º)	Inlet	69	66	64	62	63	63	64	59	74
HC 40 M4 (A0:6) (40º)	Inlet	73	69	68	66	66	66	66	62	77
HC 40 T4 (A0:6) (35º)	Inlet	69	66	64	62	63	63	64	59	74
HC 40 T4 (A0:6) (40º)	Inlet	73	69	68	66	66	66	66	62	77
HC 45 M4 (A0:6) (35º)	Inlet	71	68	66	65	65	64	66	62	76
HC 45 M4 (A0:6) (40º)	Inlet	73	70	68	67	66	66	67	62	78
HC 45 M4 (A5:6) (25º)	Inlet	45	50	57	64	63	64	66	59	71
HC 45 M4 (A5:6) (30º)	Inlet	48	53	60	64	66	67	68	59	73
HC 45 M4 (A5:6) (35º)	Inlet	50	54	62	63	68	68	69	59	74
HC 45 M4 (A5:6) (40º)	Inlet	53	56	65	66	70	70	71	62	76
HC 45 M4 (A5:6) (45º)	Inlet	52	56	64	67	71	71	72	64	77
HC 45 T4 (A0:6) (35º)	Inlet	71	68	66	65	65	64	66	62	76
HC 45 T4 (A0:6) (40º)	Inlet	73	70	68	67	66	66	67	62	78
HC 45 T4 (A5:6) (25º)	Inlet	45	50	57	64	63	64	66	59	71
HC 45 T4 (A5:6) (30º)	Inlet	48	53	60	64	66	67	68	59	73
HC 45 T4 (A5:6) (35º)	Inlet	50	54	62	63	68	68	69	59	74
HC 45 T4 (A5:6) (40º)	Inlet	53	56	65	66	70	70	71	62	76
HC 45 T4 (A5:6) (45º)	Inlet	52	56	64	67	71	71	72	64	77
HC 50 M4 (A0:6) (35º)	Inlet	72	69	69	66	66	64	66	61	77
HC 50 M4 (A0:6) (40º)	Inlet	75	72	70	68	69	67	68	63	79
HC 50 M4 (A5:6) (25º)	Inlet	44	51	56	61	64	66	68	60	72
HC 50 M4 (A5:6) (30º)	Inlet	47	52	59	63	66	67	70	61	74
HC 50 M4 (A5:6) (35º)	Inlet	49	54	61	67	69	70	72	63	77
HC 50 M4 (A5:6) (40º)	Inlet	49	56	61	67	69	70	72	63	77
HC 50 M4 (A5:6) (45º)	Inlet	52	59	64	72	73	73	75	67	80
HC 50 T4 (A0:6) (35º)	Inlet	72	69	69	66	66	64	66	61	77
HC 50 T4 (A0:6) (40º)	Inlet	75	72	70	68	69	67	68	63	79
HC 50 T4 (A5:6) (25º)	Inlet	44	51	56	61	64	66	68	60	72
HC 50 T4 (A5:6) (30º)	Inlet	47	52	59	63	66	67	70	61	74
HC 50 T4 (A5:6) (35º)	Inlet	49	54	61	67	69	70	72	63	77
HC 50 T4 (A5:6) (40º)	Inlet	49	56	61	67	69	70	72	63	77

Sound power Lw dB (A)

Model		63 Hz	125 Hz	250 Hz	500 Hz	1000 Hz	2000 Hz	4000 Hz	8000 Hz	Total
HC 50 T4 (A5:6) (45º)	Inlet	52	59	64	72	73	73	75	67	80
HC 56 M4 (A2:6) (20º)	Inlet	72	70	73	76	75	74	75	73	83
HC 56 M4 (A2:6) (25º)	Inlet	76	73	74	76	75	75	76	73	84
HC 56 M4 (A2:6) (27º)	Inlet	76	74	74	76	74	74	75	72	84
HC 56 M4 (A2:6) (30º)	Inlet	78	75	74	74	73	73	75	71	83
HC 56 M4 (A2:6) (33º)	Inlet	79	76	74	74	73	74	74	71	84
HC 56 M4 (A2:6) (35º)	Inlet	78	75	73	74	73	74	74	71	84
HC 56 M4 (A2:6) (37º)	Inlet	79	76	74	74	73	74	75	71	84
HC 56 M4 (A2:6) (40º)	Inlet	80	77	75	74	74	74	75	71	85
HC 56 M4 (A2:6) (43º)	Inlet	81	76	76	75	75	75	75	71	86
HC 56 M4 (A2:6) (45º)	Inlet	82	76	77	75	75	76	75	72	86
HC 56 M4 (A2:9) (20º)	Inlet	80	74	76	76	76	75	76	70	85
HC 56 M4 (A2:9) (25º)	Inlet	79	74	76	76	76	75	76	72	85
HC 56 M4 (A2:9) (27º)	Inlet	80	75	76	76	76	75	76	72	85
HC 56 M4 (A2:9) (30º)	Inlet	80	75	76	76	77	76	77	74	86
HC 56 M4 (A2:9) (33º)	Inlet	79	75	77	76	76	76	77	74	86
HC 56 M4 (A2:9) (35º)	Inlet	79	75	77	76	76	76	78	74	86
HC 56 M4 (A2:9) (37º)	Inlet	79	75	77	76	76	76	77	74	86
HC 56 M4 (A2:9) (40º)	Inlet	79	76	78	76	76	76	77	73	86
HC 56 M4 (A2:9) (43º)	Inlet	79	76	79	76	76	76	77	73	86
HC 56 M4 (A2:9) (45º)	Inlet	80	76	80	76	76	76	77	74	86
HC 56 M4 (A5:6) (20º)	Inlet	66	73	78	79	80	78	76	68	86
HC 56 M4 (A5:6) (25º)	Inlet	53	62	67	73	75	75	76	67	82
HC 56 M4 (A5:6) (30º)	Inlet	62	72	79	81	81	79	77	69	87
HC 56 M4 (A5:6) (35º)	Inlet	50	62	67	73	74	75	76	68	81
HC 56 M4 (A5:6) (40º)	Inlet	56	69	79	85	84	78	76	67	89
HC 56 M4 (A5:6) (45º)	Inlet	60	73	88	94	91	80	76	67	96
HC 56 T4 (A2:6) (20º)	Inlet	72	70	73	76	75	74	75	73	83
HC 56 T4 (A2:6) (25º)	Inlet	76	73	74	76	75	75	76	73	84
HC 56 T4 (A2:6) (27º)	Inlet	76	74	74	76	74	74	75	72	84
HC 56 T4 (A2:6) (30º)	Inlet	78	75	74	74	73	73	75	71	83
HC 56 T4 (A2:6) (33º)	Inlet	79	76	74	74	73	74	74	71	84
HC 56 T4 (A2:6) (35º)	Inlet	78	75	73	74	73	74	74	71	84
HC 56 T4 (A2:6) (37º)	Inlet	79	76	74	74	73	74	75	71	84
HC 56 T4 (A2:6) (40º)	Inlet	80	77	75	74	74	74	75	71	85
HC 56 T4 (A2:6) (43º)	Inlet	81	76	76	75	75	75	75	71	86
HC 56 T4 (A2:6) (45º)	Inlet	82	76	77	75	75	76	75	72	86
HC 56 T4 (A2:9) (20º)	Inlet	80	74	76	76	76	75	76	70	85
HC 56 T4 (A2:9) (25º)	Inlet	79	74	76	76	76	75	76	72	85

Sound power Lw dB (A)										
Model		63 Hz	125 Hz	250 Hz	500 Hz	1000 Hz	2000 Hz	4000 Hz	8000 Hz	Total
HC 56 T4 (A2:9) (27º)	Inlet	80	75	76	76	76	75	76	72	85
HC 56 T4 (A2:9) (30º)	Inlet	80	75	76	76	77	76	77	74	86
HC 56 T4 (A2:9) (33º)	Inlet	79	75	77	76	76	76	77	74	86
HC 56 T4 (A2:9) (35º)	Inlet	79	75	77	76	76	76	78	74	86
HC 56 T4 (A2:9) (37º)	Inlet	79	75	77	76	76	76	77	74	86
HC 56 T4 (A2:9) (40º)	Inlet	79	76	78	76	76	76	77	73	86
HC 56 T4 (A2:9) (43º)	Inlet	79	76	79	76	76	76	77	73	86
HC 56 T4 (A2:9) (45º)	Inlet	80	76	80	76	76	76	77	74	86
HC 56 T4 (A5:6) (20º)	Inlet	66	73	78	79	80	78	76	68	86
HC 56 T4 (A5:6) (25º)	Inlet	53	62	67	73	75	75	76	67	82
HC 56 T4 (A5:6) (30º)	Inlet	62	72	79	81	81	79	77	69	87
HC 56 T4 (A5:6) (35º)	Inlet	50	62	67	73	74	75	76	68	81
HC 56 T4 (A5:6) (40º)	Inlet	56	69	79	85	84	78	76	67	89
HC 56 T4 (A5:6) (45º)	Inlet	60	73	88	94	91	80	76	67	96
HC 63 M4 (A2:6) (20º)	Inlet	75	67	73	77	73	72	74	71	82
HC 63 M4 (A2:6) (25º)	Inlet	79	74	76	78	76	76	77	74	86
HC 63 M4 (A2:6) (27º)	Inlet	79	74	76	78	76	76	77	74	86
HC 63 M4 (A2:6) (30º)	Inlet	79	76	75	77	75	76	77	74	85
HC 63 M4 (A2:9) (20º)	Inlet	83	76	80	80	78	76	78	75	88
HC 63 M4 (A2:9) (25º)	Inlet	83	77	79	79	78	77	79	75	88
HC 63 M4 (A2:9) (27º)	Inlet	83	77	79	79	78	78	79	76	88
HC 63 M4 (A5:6) (20º)	Inlet	69	76	81	82	83	80	79	72	89
HC 63 M4 (A5:6) (25º)	Inlet	54	63	68	73	77	76	76	70	83
HC 63 T4 (A2:6) (20º)	Inlet	75	67	73	77	73	72	74	71	82
HC 63 T4 (A2:6) (25º)	Inlet	79	74	76	78	76	76	77	74	86
HC 63 T4 (A2:6) (27º)	Inlet	79	74	76	78	76	76	77	74	86
HC 63 T4 (A2:6) (30º)	Inlet	79	76	75	77	75	76	77	74	85
HC 63 T4 (A2:6) (33º)	Inlet	79	77	75	76	75	76	76	73	85
HC 63 T4 (A2:6) (35º)	Inlet	79	76	74	75	74	76	76	73	85
HC 63 T4 (A2:6) (37º)	Inlet	80	77	75	76	75	76	76	73	86
HC 63 T4 (A2:6) (40º)	Inlet	81	78	76	76	76	76	76	73	86
HC 63 T4 (A2:6) (43º)	Inlet	83	78	78	77	77	77	77	73	88
HC 63 T4 (A2:6) (45º)	Inlet	84	78	79	77	78	77	77	73	88
HC 63 T4 (A2:9) (20º)	Inlet	83	76	80	80	78	76	78	75	88
HC 63 T4 (A2:9) (25º)	Inlet	83	77	79	79	78	77	79	75	88
HC 63 T4 (A2:9) (27º)	Inlet	83	77	79	79	78	78	79	76	88
HC 63 T4 (A2:9) (30º)	Inlet	84	79	79	79	78	79	80	76	89
HC 63 T4 (A2:9) (33º)	Inlet	83	79	79	80	79	79	80	76	89
HC 63 T4 (A2:9) (35º)	Inlet	83	79	79	80	79	79	80	77	89

Sound power Lw dB (A)										
Model		63 Hz	125 Hz	250 Hz	500 Hz	1000 Hz	2000 Hz	4000 Hz	8000 Hz	Total
HC 63 T4 (A2:9) (37°)	Inlet	83	79	79	79	79	79	80	77	89
HC 63 T4 (A2:9) (40°)	Inlet	83	79	78	79	79	79	79	77	89
HC 63 T4 (A2:9) (43°)	Inlet	83	80	78	79	79	79	80	76	89
HC 63 T4 (A2:9) (45°)	Inlet	83	80	78	79	78	79	80	76	88
HC 63 T4 (A5:6) (20°)	Inlet	69	76	81	82	83	80	79	72	89
HC 63 T4 (A5:6) (25°)	Inlet	54	63	68	73	77	76	76	70	83
HC 63 T4 (A5:6) (30°)	Inlet	57	65	75	82	80	79	79	72	87
HC 63 T4 (A5:6) (35°)	Inlet	53	65	70	74	78	77	79	72	84
HC 63 T4 (A5:6) (40°)	Inlet	54	66	77	89	86	81	79	71	92
HC 63 T4 (A5:6) (45°)	Inlet	55	66	82	100	92	84	79	71	100
HC 71 M4 (A2:6) (20°)	Inlet	81	77	81	82	83	81	83	79	90
HC 71 M4 (A2:6) (25°)	Inlet	83	79	80	82	81	81	82	78	90
HC 71 M4 (A2:9) (20°)	Inlet	86	82	84	86	85	84	86	80	94
HC 71 M4 (A5:6) (20°)	Inlet	71	78	83	85	85	83	82	75	92
HC 71 T4 (A2:6) (20°)	Inlet	81	77	81	82	83	81	83	79	90
HC 71 T4 (A2:6) (25°)	Inlet	83	79	80	82	81	81	82	78	90
HC 71 T4 (A2:6) (27°)	Inlet	83	79	80	81	80	80	82	78	90
HC 71 T4 (A2:6) (30°)	Inlet	84	80	79	81	79	80	81	78	90
HC 71 T4 (A2:6) (33°)	Inlet	83	80	78	79	78	79	80	76	89
HC 71 T4 (A2:6) (35°)	Inlet	83	80	78	78	77	78	79	75	88
HC 71 T4 (A2:6) (37°)	Inlet	84	81	79	79	78	79	79	75	89
HC 71 T4 (A2:6) (40°)	Inlet	85	82	80	80	80	80	79	75	90
HC 71 T4 (A2:6) (43°)	Inlet	87	82	82	80	80	80	79	75	91
HC 71 T4 (A2:6) (45°)	Inlet	88	82	83	80	80	80	80	75	91
HC 71 T4 (A2:9) (20°)	Inlet	86	82	84	86	85	84	86	80	94
HC 71 T4 (A2:9) (25°)	Inlet	86	83	83	84	83	83	84	80	93
HC 71 T4 (A2:9) (27°)	Inlet	86	83	82	84	83	82	84	80	92
HC 71 T4 (A2:9) (30°)	Inlet	86	83	81	82	82	82	83	79	92
HC 71 T4 (A2:9) (33°)	Inlet	86	83	81	82	82	82	82	79	92
HC 71 T4 (A2:9) (35°)	Inlet	86	83	81	82	82	82	82	79	91
HC 71 T4 (A2:9) (37°)	Inlet	87	84	82	82	82	82	82	79	92
HC 71 T4 (A2:9) (40°)	Inlet	87	84	82	81	82	82	82	79	92
HC 71 T4 (A2:9) (43°)	Inlet	86	84	82	81	81	82	82	78	92
HC 71 T4 (A2:9) (45°)	Inlet	86	84	82	81	81	81	81	77	91
HC 71 T4 (A5:6) (20°)	Inlet	71	78	83	85	85	83	82	75	92
HC 71 T4 (A5:6) (25°)	Inlet	58	68	74	78	81	82	82	73	88
HC 71 T4 (A5:6) (30°)	Inlet	60	68	75	81	82	81	81	72	87
HC 71 T4 (A5:6) (35°)	Inlet	53	65	70	75	78	79	80	71	84
HC 71 T4 (A5:6) (40°)	Inlet	57	68	83	92	88	83	81	72	95

Sound power Lw dB (A)										
Model		63 Hz	125 Hz	250 Hz	500 Hz	1000 Hz	2000 Hz	4000 Hz	8000 Hz	Total
HC 71 T4 (A5:6) (45°)	Inlet	61	70	92	105	96	87	83	72	105
HC 80 T4 (A2:6) (20°)	Inlet	80	77	80	82	83	82	83	80	90
HC 80 T4 (A2:6) (25°)	Inlet	83	80	81	82	83	82	83	80	91
HC 80 T4 (A2:6) (27°)	Inlet	84	81	81	82	82	82	83	80	91
HC 80 T4 (A2:6) (30°)	Inlet	86	83	81	82	82	83	83	79	92
HC 80 T4 (A2:6) (33°)	Inlet	87	84	82	82	82	83	83	78	92
HC 80 T4 (A2:6) (35°)	Inlet	88	85	83	81	81	83	83	78	92
HC 80 T4 (A2:6) (37°)	Inlet	88	85	83	81	81	82	82	77	92
HC 80 T4 (A2:6) (40°)	Inlet	87	85	83	81	81	81	81	76	92
HC 80 T4 (A2:6) (43°)	Inlet	88	85	84	82	82	81	81	76	93
HC 80 T4 (A2:6) (45°)	Inlet	88	85	84	82	82	81	81	76	93
HC 80 T4 (A2:9) (20°)	Inlet	86	88	86	92	91	88	91	85	98
HC 80 T4 (A2:9) (25°)	Inlet	88	87	85	90	89	87	89	84	97
HC 80 T4 (A2:9) (27°)	Inlet	88	87	85	89	88	87	88	84	96
HC 80 T4 (A2:9) (30°)	Inlet	89	86	84	87	87	87	87	83	96
HC 80 T4 (A2:9) (33°)	Inlet	89	86	84	86	86	86	86	82	95
HC 80 T4 (A2:9) (35°)	Inlet	88	85	83	84	85	86	85	81	94
HC 80 T4 (A2:9) (37°)	Inlet	89	86	84	84	85	86	85	81	95
HC 80 T4 (A2:9) (40°)	Inlet	90	87	85	84	84	85	85	80	95
HC 80 T4 (A2:9) (43°)	Inlet	90	88	86	84	84	84	83	79	95
HC 80 T4 (A2:9) (45°)	Inlet	90	87	86	84	84	84	83	79	95
HC 80 T4 (A5:6) (20°)	Inlet	74	81	86	88	88	86	85	78	94
HC 80 T4 (A5:6) (25°)	Inlet	61	68	74	79	81	81	82	74	88
HC 80 T4 (A5:6) (30°)	Inlet	61	72	79	89	87	85	85	77	93
HC 80 T4 (A5:6) (35°)	Inlet	58	70	76	84	89	87	87	78	94
HC 80 T4 (A5:6) (40°)	Inlet	59	72	88	93	90	86	84	76	97
HC 90 T4 (A6:3) (20°)	Inlet	86	79	81	78	79	79	83	79	90
HC 90 T4 (A6:3) (22°)	Inlet	87	81	82	80	81	81	84	80	92
HC 90 T4 (A6:3) (24°)	Inlet	88	83	84	82	82	82	85	81	93
HC 90 T4 (A6:3) (26°)	Inlet	89	84	85	84	83	83	86	82	94
HC 90 T4 (A6:3) (28°)	Inlet	90	85	86	85	84	84	86	83	95
HC 90 T4 (A6:3) (30°)	Inlet	91	87	87	87	85	85	87	83	96
HC 90 T4 (A6:3) (32°)	Inlet	91	87	87	89	86	86	87	84	97
HC 90 T4 (A6:3) (34°)	Inlet	92	88	88	90	87	87	88	84	97
HC 90 T4 (A6:3) (36°)	Inlet	92	88	88	91	87	88	88	85	98
HC 90 T4 (A6:3) (38°)	Inlet	92	89	89	92	89	89	89	86	99
HC 90 T4 (A6:3) (40°)	Inlet	92	90	90	92	90	90	90	87	99
HC 90 T4 (A6:3) (42°)	Inlet	93	91	91	93	91	91	91	87	101
HC 90 T4 (A6:6) (20°)	Inlet	91	91	90	91	92	89	90	87	99

Sound power Lw dB (A)										
Model		63 Hz	125 Hz	250 Hz	500 Hz	1000 Hz	2000 Hz	4000 Hz	8000 Hz	Total
HC 90 T4 (A6:6) (22°)	Inlet	92	91	90	92	92	90	90	88	100
HC 90 T4 (A6:6) (24°)	Inlet	93	92	91	92	92	90	91	88	101
HC 90 T4 (A6:6) (26°)	Inlet	93	93	91	93	92	90	91	89	101
HC 90 T4 (A6:6) (28°)	Inlet	94	93	92	93	92	91	92	89	102
HC 90 T4 (A6:6) (30°)	Inlet	95	94	92	93	92	91	92	90	102
HC 90 T4 (A6:6) (32°)	Inlet	94	93	91	92	90	89	91	88	101
HC 90 T4 (A6:6) (34°)	Inlet	92	91	89	90	88	88	90	86	99
HC 90 T4 (A6:6) (36°)	Inlet	92	91	89	89	88	88	89	86	98
HC 90 T4 (A6:6) (38°)	Inlet	93	92	90	90	88	88	90	86	99
HC 90 T4 (A6:6) (40°)	Inlet	94	92	90	91	89	89	90	86	100
HC 90 T4 (A6:6) (42°)	Inlet	94	93	91	91	89	89	90	86	101
HC 100 T4 (A6:3) (20°)	Inlet	90	87	85	84	87	87	91	85	97
HC 100 T4 (A6:3) (22°)	Inlet	91	88	86	86	87	88	91	86	97
HC 100 T4 (A6:3) (24°)	Inlet	92	88	87	86	87	87	90	86	97
HC 100 T4 (A6:3) (26°)	Inlet	92	88	87	86	87	87	90	85	97
HC 100 T4 (A6:3) (28°)	Inlet	92	88	87	86	86	87	89	85	97
HC 100 T4 (A6:3) (30°)	Inlet	92	88	87	87	86	86	88	84	97
HC 100 T4 (A6:3) (32°)	Inlet	94	89	89	88	87	87	89	85	98
HC 100 T4 (A6:3) (34°)	Inlet	95	91	90	90	89	89	89	86	100
HC 100 T4 (A6:3) (36°)	Inlet	95	91	91	91	90	89	90	87	101
HC 100 T4 (A6:3) (38°)	Inlet	95	92	91	92	90	90	90	87	101
HC 100 T4 (A6:3) (40°)	Inlet	95	93	91	93	91	91	91	88	101
HC 100 T4 (A6:3) (42°)	Inlet	95	93	92	93	92	92	92	89	102
HC 100 T4 (A6:6) (20°)	Inlet	95	96	94	98	96	94	94	92	105
HC 100 T4 (A6:6) (22°)	Inlet	95	96	94	98	95	94	94	92	105
HC 100 T4 (A6:6) (24°)	Inlet	96	96	94	97	95	94	94	92	104
HC 100 T4 (A6:6) (26°)	Inlet	97	97	95	97	95	94	95	92	105
HC 100 T4 (A6:6) (28°)	Inlet	99	97	96	98	95	94	95	93	106
HC 100 T4 (A6:6) (30°)	Inlet	99	97	96	97	95	94	96	93	106
HC 100 T4 (A6:6) (32°)	Inlet	98	97	95	95	94	93	94	91	105
HC 100 T4 (A6:6) (34°)	Inlet	98	96	95	93	92	92	93	90	104
HC 100 T4 (A6:6) (36°)	Inlet	97	95	94	92	92	91	93	89	103
HC 100 T4 (A6:6) (38°)	Inlet	98	96	95	93	92	92	93	90	104
HC 100 T4 (A6:6) (40°)	Inlet	99	97	95	94	93	93	94	90	105
HC 100 T4 (A6:6) (42°)	Inlet	98	96	95	94	93	93	94	90	104
HC 112 T4 (A6:3) (20°)	Inlet	93	90	88	89	91	91	93	90	101
HC 112 T4 (A6:3) (22°)	Inlet	95	92	90	90	92	92	94	91	102
HC 112 T4 (A6:3) (24°)	Inlet	96	93	91	91	92	92	94	91	102
HC 112 T4 (A6:3) (26°)	Inlet	97	93	92	92	92	92	95	91	103

Sound power Lw dB (A)										
Model		63 Hz	125 Hz	250 Hz	500 Hz	1000 Hz	2000 Hz	4000 Hz	8000 Hz	Total
HC 112 T4 (A6:3) (28°)	Inlet	97	93	92	92	92	92	94	91	103
HC 112 T4 (A6:3) (30°)	Inlet	97	93	92	92	92	91	94	91	103
HC 112 T4 (A6:3) (32°)	Inlet	98	93	93	92	92	91	93	91	103
HC 112 T4 (A6:3) (34°)	Inlet	99	93	94	93	92	91	93	91	103
HC 112 T4 (A6:3) (36°)	Inlet	99	94	94	93	92	92	93	91	104
HC 112 T4 (A6:3) (38°)	Inlet	99	95	94	94	93	92	93	91	104
HC 112 T4 (A6:3) (40°)	Inlet	99	95	94	94	93	93	93	91	104
HC 112 T4 (A6:3) (42°)	Inlet	99	96	94	95	94	94	94	91	104
HC 112 T4 (A6:6) (20°)	Inlet	95	96	95	101	98	96	97	94	106
HC 112 T4 (A6:6) (22°)	Inlet	96	96	95	99	98	96	97	94	106
HC 112 T4 (A6:6) (24°)	Inlet	97	96	95	98	97	95	96	93	106
HC 112 T4 (A6:6) (26°)	Inlet	98	97	95	98	97	96	97	93	106
HC 112 T4 (A6:6) (28°)	Inlet	100	98	96	98	97	96	97	93	107
HC 112 T4 (A6:6) (30°)	Inlet	101	98	96	97	96	96	97	92	107
HC 112 T4 (A6:6) (32°)	Inlet	101	97	95	95	95	95	96	91	106
HC 112 T4 (A6:6) (34°)	Inlet	100	97	95	94	94	94	95	90	105
HC 112 T4 (A6:6) (36°)	Inlet	101	98	96	94	94	94	95	90	106
HC 112 T4 (A6:6) (38°)	Inlet	103	99	98	95	96	96	97	92	107
HC 112 T4 (A6:6) (40°)	Inlet	105	101	99	97	97	97	98	93	109
HC 112 T4 (A6:6) (42°)	Inlet	105	100	99	97	97	97	97	93	109
HC 125 T4 (A7:4) (20°)	Inlet	98	102	99	101	102	101	103	102	110
HC 125 T4 (A7:4) (22°)	Inlet	101	103	101	102	102	102	104	102	111
HC 125 T4 (A7:4) (24°)	Inlet	102	101	99	99	100	100	102	99	109
HC 125 T4 (A7:4) (26°)	Inlet	102	100	98	97	98	98	99	96	108
HC 125 T4 (A7:4) (28°)	Inlet	102	98	96	95	96	97	98	94	107
HC 125 T4 (A7:4) (30°)	Inlet	100	97	95	93	94	95	96	91	105
HC 125 T4 (A7:4) (32°)	Inlet	100	97	95	93	93	94	95	90	105
HC 125 T4 (A7:4) (34°)	Inlet	99	96	94	93	93	94	95	89	105
HC 125 T4 (A7:4) (36°)	Inlet	100	97	95	93	93	94	95	89	105
HC 125 T4 (A7:4) (38°)	Inlet	101	98	96	94	94	95	95	90	106
HC 125 T4 (A7:4) (40°)	Inlet	102	98	96	95	94	95	95	91	106
HC 125 T4 (A7:4) (42°)	Inlet	102	99	97	95	95	96	96	91	107
HC 125 T4 (A7:8) (20°)	Inlet	104	102	101	104	107	109	108	105	115
HC 125 T4 (A7:8) (22°)	Inlet	104	101	101	103	106	108	107	104	114
HC 125 T4 (A7:8) (24°)	Inlet	104	101	100	102	105	106	106	102	113
HC 125 T4 (A7:8) (26°)	Inlet	104	100	99	101	103	105	105	101	112
HC 125 T4 (A7:8) (28°)	Inlet	104	99	99	99	102	104	104	99	111
HC 125 T4 (A7:8) (30°)	Inlet	103	99	98	98	100	102	102	97	110
HC 125 T4 (A7:8) (32°)	Inlet	103	99	98	97	99	100	101	95	109

Sound power Lw dB (A)										
Model		63 Hz	125 Hz	250 Hz	500 Hz	1000 Hz	2000 Hz	4000 Hz	8000 Hz	Total
HC 125 T4 (A7:8) (34°)	Inlet	104	99	98	97	98	99	99	93	109
HC 125 T4 (A7:8) (36°)	Inlet	104	100	98	97	97	98	98	92	108
HC 125 T4 (A7:8) (38°)	Inlet	104	101	98	97	97	98	97	92	108
HC 125 T4 (A7:8) (40°)	Inlet	103	100	98	97	97	98	96	92	108
HC 125 T4 (A7:8) (42°)	Inlet	103	100	98	97	97	97	96	92	108

Sound / 6 poles

Sound power Lw dB (A)										
Model		63 Hz	125 Hz	250 Hz	500 Hz	1000 Hz	2000 Hz	4000 Hz	8000 Hz	Total
HC 35 T6 (A0:6) (35°)	Inlet	56	54	53	51	50	50	51	48	61
HC 35 T6 (A0:6) (40°)	Inlet	58	55	54	53	52	52	53	49	63
HC 40 T6 (A0:6) (35°)	Inlet	60	57	55	53	53	54	55	49	64
HC 40 T6 (A0:6) (40°)	Inlet	64	60	59	56	56	56	57	52	68
HC 45 M6 (A0:6) (35°)	Inlet	61	59	57	56	56	55	57	52	66
HC 45 M6 (A0:6) (40°)	Inlet	64	61	59	57	57	56	57	53	68
HC 45 M6 (A5:6) (25°)	Inlet	36	41	48	55	53	55	57	49	62
HC 45 M6 (A5:6) (30°)	Inlet	39	44	51	55	57	58	59	50	64
HC 45 M6 (A5:6) (35°)	Inlet	40	44	52	53	58	58	60	49	65
HC 45 M6 (A5:6) (40°)	Inlet	43	47	55	57	60	60	62	53	67
HC 45 M6 (A5:6) (45°)	Inlet	42	46	54	58	61	62	63	55	68
HC 45 T6 (A0:6) (35°)	Inlet	61	59	57	56	56	55	57	52	66
HC 45 T6 (A0:6) (40°)	Inlet	64	61	59	57	57	56	57	53	68
HC 45 T6 (A5:6) (25°)	Inlet	36	41	48	55	53	55	57	49	62
HC 45 T6 (A5:6) (30°)	Inlet	39	44	51	55	57	58	59	50	64
HC 45 T6 (A5:6) (35°)	Inlet	40	44	52	53	58	58	60	49	65
HC 45 T6 (A5:6) (40°)	Inlet	43	47	55	57	60	60	62	53	67
HC 45 T6 (A5:6) (45°)	Inlet	42	46	54	58	61	62	63	55	68
HC 50 M6 (A0:6) (35°)	Inlet	63	60	59	57	56	55	56	51	67
HC 50 M6 (A0:6) (40°)	Inlet	66	63	61	59	59	57	59	54	70
HC 50 M6 (A5:6) (25°)	Inlet	35	42	47	52	54	57	59	51	63
HC 50 M6 (A5:6) (30°)	Inlet	38	43	50	54	57	58	61	52	65
HC 50 M6 (A5:6) (35°)	Inlet	39	44	51	58	60	61	63	54	67
HC 50 M6 (A5:6) (40°)	Inlet	40	47	52	58	60	61	63	54	67
HC 50 M6 (A5:6) (45°)	Inlet	43	50	55	63	64	64	66	58	71
HC 50 T6 (A0:6) (35°)	Inlet	63	60	59	57	56	55	56	51	67
HC 50 T6 (A0:6) (40°)	Inlet	66	63	61	59	59	57	59	54	70
HC 50 T6 (A5:6) (25°)	Inlet	35	42	47	52	54	57	59	51	63

Sound power Lw dB (A)										
Model		63 Hz	125 Hz	250 Hz	500 Hz	1000 Hz	2000 Hz	4000 Hz	8000 Hz	Total
HC 50 T6 (A5:6) (30°)	Inlet	38	43	50	54	57	58	61	52	65
HC 50 T6 (A5:6) (35°)	Inlet	39	44	51	58	60	61	63	54	67
HC 50 T6 (A5:6) (40°)	Inlet	40	47	52	58	60	61	63	54	67
HC 50 T6 (A5:6) (45°)	Inlet	43	50	55	63	64	64	66	58	71
HC 56 M6 (A2:6) (20°)	Inlet	63	61	63	67	65	65	66	63	73
HC 56 M6 (A2:6) (25°)	Inlet	66	64	65	67	66	65	66	63	75
HC 56 M6 (A2:6) (27°)	Inlet	67	64	65	66	65	65	66	63	74
HC 56 M6 (A2:6) (30°)	Inlet	68	65	64	64	64	64	65	61	74
HC 56 M6 (A2:6) (33°)	Inlet	69	66	64	64	63	64	65	62	74
HC 56 M6 (A2:6) (35°)	Inlet	69	66	64	64	63	64	65	62	74
HC 56 M6 (A2:6) (37°)	Inlet	70	67	65	65	64	65	65	61	75
HC 56 M6 (A2:6) (40°)	Inlet	71	68	66	65	64	65	66	61	75
HC 56 M6 (A2:6) (43°)	Inlet	72	67	67	65	65	66	66	62	76
HC 56 M6 (A2:6) (45°)	Inlet	73	66	68	66	66	66	66	62	77
HC 56 M6 (A2:9) (20°)	Inlet	70	65	66	67	67	66	66	61	76
HC 56 M6 (A2:9) (25°)	Inlet	70	65	66	67	67	66	67	62	76
HC 56 M6 (A2:9) (27°)	Inlet	70	65	67	67	67	66	67	63	76
HC 56 M6 (A2:9) (30°)	Inlet	70	66	67	67	67	67	68	64	76
HC 56 M6 (A2:9) (33°)	Inlet	70	65	67	67	67	67	68	64	76
HC 56 M6 (A2:9) (35°)	Inlet	69	65	67	67	67	67	68	64	76
HC 56 M6 (A2:9) (37°)	Inlet	69	66	68	67	67	66	68	64	76
HC 56 M6 (A2:9) (40°)	Inlet	70	66	68	66	67	66	67	64	76
HC 56 M6 (A2:9) (43°)	Inlet	70	66	70	67	67	67	67	64	77
HC 56 M6 (A2:9) (45°)	Inlet	70	67	70	67	67	67	67	64	77
HC 56 M6 (A5:6) (20°)	Inlet	63	70	75	76	77	75	73	65	82
HC 56 M6 (A5:6) (25°)	Inlet	50	59	64	70	72	72	73	64	78
HC 56 M6 (A5:6) (30°)	Inlet	58	68	75	77	78	76	74	66	83
HC 56 M6 (A5:6) (35°)	Inlet	47	58	63	69	70	71	72	64	78
HC 56 M6 (A5:6) (40°)	Inlet	53	66	76	81	81	75	73	64	85
HC 56 M6 (A5:6) (45°)	Inlet	57	69	84	90	88	77	73	63	93
HC 56 T6 (A2:6) (20°)	Inlet	63	61	63	67	65	65	66	63	73
HC 56 T6 (A2:6) (25°)	Inlet	66	64	65	67	66	65	66	63	75
HC 56 T6 (A2:6) (27°)	Inlet	67	64	65	66	65	65	66	63	74
HC 56 T6 (A2:6) (30°)	Inlet	68	65	64	64	64	64	65	61	74
HC 56 T6 (A2:6) (33°)	Inlet	69	66	64	64	63	64	65	62	74
HC 56 T6 (A2:6) (35°)	Inlet	69	66	64	64	63	64	65	62	74
HC 56 T6 (A2:6) (37°)	Inlet	70	67	65	65	64	65	65	61	75
HC 56 T6 (A2:6) (40°)	Inlet	71	68	66	65	64	65	66	61	75
HC 56 T6 (A2:6) (43°)	Inlet	72	67	67	65	65	66	66	62	76

Sound power Lw dB (A)

Model		63 Hz	125 Hz	250 Hz	500 Hz	1000 Hz	2000 Hz	4000 Hz	8000 Hz	Total
HC 56 T6 (A2:6) (45º)	Inlet	73	66	68	66	66	66	66	62	77
HC 56 T6 (A2:9) (20º)	Inlet	70	65	66	67	67	66	66	61	76
HC 56 T6 (A2:9) (25º)	Inlet	70	65	66	67	67	66	67	62	76
HC 56 T6 (A2:9) (27º)	Inlet	70	65	67	67	67	66	67	63	76
HC 56 T6 (A2:9) (30º)	Inlet	70	66	67	67	67	67	68	64	76
HC 56 T6 (A2:9) (33º)	Inlet	70	65	67	67	67	67	68	64	76
HC 56 T6 (A2:9) (35º)	Inlet	69	65	67	67	67	67	68	64	76
HC 56 T6 (A2:9) (37º)	Inlet	69	66	68	67	67	66	68	64	76
HC 56 T6 (A2:9) (40º)	Inlet	70	66	68	66	67	66	67	64	76
HC 56 T6 (A2:9) (43º)	Inlet	70	66	70	67	67	67	67	64	77
HC 56 T6 (A2:9) (45º)	Inlet	70	67	70	67	67	67	67	64	77
HC 56 T6 (A5:6) (20º)	Inlet	63	70	75	76	77	75	73	65	82
HC 56 T6 (A5:6) (25º)	Inlet	50	59	64	70	72	72	73	64	78
HC 56 T6 (A5:6) (30º)	Inlet	58	68	75	77	78	76	74	66	83
HC 56 T6 (A5:6) (35º)	Inlet	47	58	63	69	70	71	72	64	78
HC 56 T6 (A5:6) (40º)	Inlet	53	66	76	81	81	75	73	64	85
HC 56 T6 (A5:6) (45º)	Inlet	57	69	84	90	88	77	73	63	93
HC 63 M6 (A2:6) (20º)	Inlet	65	58	63	67	64	63	65	61	73
HC 63 M6 (A2:6) (25º)	Inlet	69	64	67	69	67	67	68	65	76
HC 63 M6 (A2:6) (27º)	Inlet	69	65	66	68	67	67	68	65	76
HC 63 M6 (A2:6) (30º)	Inlet	70	67	66	67	66	67	67	65	76
HC 63 M6 (A2:6) (33º)	Inlet	70	67	65	67	65	67	67	64	76
HC 63 M6 (A2:6) (35º)	Inlet	70	67	65	66	65	66	67	63	75
HC 63 M6 (A2:6) (37º)	Inlet	71	68	66	66	66	67	67	63	76
HC 63 M6 (A2:6) (40º)	Inlet	72	68	67	67	66	67	67	63	77
HC 63 M6 (A2:6) (43º)	Inlet	74	69	69	68	68	68	68	64	78
HC 63 M6 (A2:6) (45º)	Inlet	75	69	70	68	68	68	68	64	79
HC 63 M6 (A2:9) (20º)	Inlet	74	66	70	70	69	67	69	66	79
HC 63 M6 (A2:9) (25º)	Inlet	74	67	69	70	69	68	69	66	79
HC 63 M6 (A2:9) (27º)	Inlet	74	68	69	70	69	68	70	66	79
HC 63 M6 (A2:9) (30º)	Inlet	74	69	69	70	69	69	70	67	79
HC 63 M6 (A2:9) (33º)	Inlet	74	69	70	70	69	69	70	67	79
HC 63 M6 (A2:9) (35º)	Inlet	73	70	70	70	69	70	71	67	79
HC 63 M6 (A2:9) (37º)	Inlet	74	70	69	70	69	70	70	67	79
HC 63 M6 (A2:9) (40º)	Inlet	74	70	69	69	69	69	70	67	79
HC 63 M6 (A2:9) (43º)	Inlet	73	70	68	69	69	69	70	67	79
HC 63 M6 (A2:9) (45º)	Inlet	73	70	68	69	69	69	70	67	79
HC 63 M6 (A5:6) (20º)	Inlet	66	73	78	79	80	77	76	69	85
HC 63 M6 (A5:6) (25º)	Inlet	51	60	65	70	74	73	73	67	79

Sound power Lw dB (A)										
Model		63 Hz	125 Hz	250 Hz	500 Hz	1000 Hz	2000 Hz	4000 Hz	8000 Hz	Total
HC 63 M6 (A5:6) (30°)	Inlet	54	62	72	79	77	76	76	69	83
HC 63 M6 (A5:6) (35°)	Inlet	50	62	67	71	75	74	76	69	81
HC 63 M6 (A5:6) (40°)	Inlet	51	63	74	86	83	78	76	68	88
HC 63 M6 (A5:6) (45°)	Inlet	52	63	79	96	88	81	76	67	97
HC 63 T6 (A2:6) (20°)	Inlet	65	58	63	67	64	63	65	61	73
HC 63 T6 (A2:6) (25°)	Inlet	69	64	67	69	67	67	68	65	76
HC 63 T6 (A2:6) (27°)	Inlet	69	65	66	68	67	67	68	65	76
HC 63 T6 (A2:6) (30°)	Inlet	70	67	66	67	66	67	67	65	76
HC 63 T6 (A2:6) (33°)	Inlet	70	67	65	67	65	67	67	64	76
HC 63 T6 (A2:6) (35°)	Inlet	70	67	65	66	65	66	67	63	75
HC 63 T6 (A2:6) (37°)	Inlet	71	68	66	66	66	67	67	63	76
HC 63 T6 (A2:6) (40°)	Inlet	72	68	67	67	66	67	67	63	77
HC 63 T6 (A2:6) (43°)	Inlet	74	69	69	68	68	68	68	64	78
HC 63 T6 (A2:6) (45°)	Inlet	75	69	70	68	68	68	68	64	79
HC 63 T6 (A2:9) (20°)	Inlet	74	66	70	70	69	67	69	66	79
HC 63 T6 (A2:9) (25°)	Inlet	74	67	69	70	69	68	69	66	79
HC 63 T6 (A2:9) (27°)	Inlet	74	68	69	70	69	68	70	66	79
HC 63 T6 (A2:9) (30°)	Inlet	74	69	69	70	69	69	70	67	79
HC 63 T6 (A2:9) (33°)	Inlet	74	69	70	70	69	69	70	67	79
HC 63 T6 (A2:9) (35°)	Inlet	73	70	70	70	69	70	71	67	79
HC 63 T6 (A2:9) (37°)	Inlet	74	70	69	70	69	70	70	67	79
HC 63 T6 (A2:9) (40°)	Inlet	74	70	69	69	69	69	70	67	79
HC 63 T6 (A2:9) (43°)	Inlet	73	70	68	69	69	69	70	67	79
HC 63 T6 (A2:9) (45°)	Inlet	73	70	68	69	69	69	70	67	79
HC 63 T6 (A5:6) (20°)	Inlet	66	73	78	79	80	77	76	69	85
HC 63 T6 (A5:6) (25°)	Inlet	51	60	65	70	74	73	73	67	79
HC 63 T6 (A5:6) (30°)	Inlet	54	62	72	79	77	76	76	69	83
HC 63 T6 (A5:6) (35°)	Inlet	50	62	67	71	75	74	76	69	81
HC 63 T6 (A5:6) (40°)	Inlet	51	63	74	86	83	78	76	68	88
HC 63 T6 (A5:6) (45°)	Inlet	52	63	79	96	88	81	76	67	97
HC 71 M6 (A2:6) (20°)	Inlet	71	67	71	73	73	71	74	69	81
HC 71 M6 (A2:6) (25°)	Inlet	73	69	71	72	72	71	73	69	80
HC 71 M6 (A2:6) (27°)	Inlet	74	70	70	72	71	71	72	69	80
HC 71 M6 (A2:6) (30°)	Inlet	74	71	70	71	70	71	71	68	80
HC 71 M6 (A2:6) (33°)	Inlet	74	71	69	70	69	70	70	67	79
HC 71 M6 (A2:6) (35°)	Inlet	73	70	68	69	68	69	70	65	79
HC 71 M6 (A2:6) (37°)	Inlet	75	72	70	69	69	70	70	66	80
HC 71 M6 (A2:6) (40°)	Inlet	76	73	71	70	70	70	70	66	81
HC 71 M6 (A2:6) (43°)	Inlet	77	72	72	71	71	70	70	66	81

Sound power Lw dB (A)										
Model		63 Hz	125 Hz	250 Hz	500 Hz	1000 Hz	2000 Hz	4000 Hz	8000 Hz	Total
HC 71 M6 (A2:6) (45º)	Inlet	78	72	73	71	71	70	70	66	82
HC 71 M6 (A2:9) (20º)	Inlet	77	73	75	76	76	74	76	71	84
HC 71 M6 (A2:9) (25º)	Inlet	77	73	73	75	74	73	75	70	83
HC 71 M6 (A2:9) (27º)	Inlet	77	73	73	74	74	73	74	70	83
HC 71 M6 (A2:9) (30º)	Inlet	77	73	72	73	72	72	73	70	82
HC 71 M6 (A2:9) (33º)	Inlet	76	73	71	73	73	73	73	70	82
HC 71 M6 (A2:9) (35º)	Inlet	76	73	71	73	73	73	73	69	82
HC 71 M6 (A2:9) (37º)	Inlet	77	74	72	72	73	73	73	69	83
HC 71 M6 (A2:9) (40º)	Inlet	78	75	73	72	73	73	73	69	83
HC 71 M6 (A2:9) (43º)	Inlet	77	74	73	72	72	72	72	68	82
HC 71 M6 (A2:9) (45º)	Inlet	77	74	72	72	72	72	72	68	82
HC 71 M6 (A5:6) (20º)	Inlet	68	75	80	82	82	80	79	72	88
HC 71 M6 (A5:6) (25º)	Inlet	55	65	71	75	78	79	79	70	84
HC 71 M6 (A5:6) (30º)	Inlet	57	65	71	77	78	78	77	68	84
HC 71 M6 (A5:6) (35º)	Inlet	49	61	66	71	74	75	76	67	81
HC 71 M6 (A5:6) (40º)	Inlet	54	64	79	89	85	80	78	68	91
HC 71 M6 (A5:6) (45º)	Inlet	57	66	88	101	92	83	79	69	102
HC 71 T6 (A2:6) (20º)	Inlet	71	67	71	73	73	71	74	69	81
HC 71 T6 (A2:6) (25º)	Inlet	73	69	71	72	72	71	73	69	80
HC 71 T6 (A2:6) (27º)	Inlet	74	70	70	72	71	71	72	69	80
HC 71 T6 (A2:6) (30º)	Inlet	74	71	70	71	70	71	71	68	80
HC 71 T6 (A2:6) (33º)	Inlet	74	71	69	70	69	70	70	67	79
HC 71 T6 (A2:6) (35º)	Inlet	73	70	68	69	68	69	70	65	79
HC 71 T6 (A2:6) (37º)	Inlet	75	72	70	69	69	70	70	66	80
HC 71 T6 (A2:6) (40º)	Inlet	76	73	71	70	70	70	70	66	81
HC 71 T6 (A2:6) (43º)	Inlet	77	72	72	71	71	70	70	66	81
HC 71 T6 (A2:6) (45º)	Inlet	78	72	73	71	71	70	70	66	82
HC 71 T6 (A2:9) (20º)	Inlet	77	73	75	76	76	74	76	71	84
HC 71 T6 (A2:9) (25º)	Inlet	77	73	73	75	74	73	75	70	83
HC 71 T6 (A2:9) (27º)	Inlet	77	73	73	74	74	73	74	70	83
HC 71 T6 (A2:9) (30º)	Inlet	77	73	72	73	72	72	73	70	82
HC 71 T6 (A2:9) (33º)	Inlet	76	73	71	73	73	73	73	70	82
HC 71 T6 (A2:9) (35º)	Inlet	76	73	71	73	73	73	73	69	82
HC 71 T6 (A2:9) (37º)	Inlet	77	74	72	72	73	73	73	69	83
HC 71 T6 (A2:9) (40º)	Inlet	78	75	73	72	73	73	73	69	83
HC 71 T6 (A2:9) (43º)	Inlet	77	74	73	72	72	72	72	68	82
HC 71 T6 (A2:9) (45º)	Inlet	77	74	72	72	72	72	72	68	82
HC 71 T6 (A5:6) (20º)	Inlet	68	75	80	82	82	80	79	72	88
HC 71 T6 (A5:6) (25º)	Inlet	55	65	71	75	78	79	79	70	84

Sound power Lw dB (A)										
Model		63 Hz	125 Hz	250 Hz	500 Hz	1000 Hz	2000 Hz	4000 Hz	8000 Hz	Total
HC 71 T6 (A5:6) (30°)	Inlet	57	65	71	77	78	78	77	68	84
HC 71 T6 (A5:6) (35°)	Inlet	49	61	66	71	74	75	76	67	81
HC 71 T6 (A5:6) (40°)	Inlet	54	64	79	89	85	80	78	68	91
HC 71 T6 (A5:6) (45°)	Inlet	57	66	88	101	92	83	79	69	102
HC 80 T6 (A2:6) (20°)	Inlet	71	68	71	73	74	72	74	71	81
HC 80 T6 (A2:6) (25°)	Inlet	74	71	71	73	73	73	74	70	82
HC 80 T6 (A2:6) (27°)	Inlet	75	72	71	73	73	73	74	70	82
HC 80 T6 (A2:6) (30°)	Inlet	76	73	71	72	72	73	74	69	82
HC 80 T6 (A2:6) (33°)	Inlet	77	74	72	72	72	73	74	69	83
HC 80 T6 (A2:6) (35°)	Inlet	78	75	73	72	72	73	73	68	83
HC 80 T6 (A2:6) (37°)	Inlet	79	76	74	72	72	72	72	68	83
HC 80 T6 (A2:6) (40°)	Inlet	78	76	74	72	72	72	71	67	83
HC 80 T6 (A2:6) (43°)	Inlet	78	76	75	72	72	72	72	67	83
HC 80 T6 (A2:6) (45°)	Inlet	79	76	75	73	73	72	72	67	83
HC 80 T6 (A2:9) (20°)	Inlet	76	78	77	83	82	79	81	75	89
HC 80 T6 (A2:9) (25°)	Inlet	78	78	76	80	79	78	79	74	87
HC 80 T6 (A2:9) (27°)	Inlet	79	78	76	79	79	78	79	74	87
HC 80 T6 (A2:9) (30°)	Inlet	80	77	75	77	77	77	78	74	86
HC 80 T6 (A2:9) (33°)	Inlet	80	77	75	76	77	77	77	73	86
HC 80 T6 (A2:9) (35°)	Inlet	79	76	74	75	76	76	76	72	85
HC 80 T6 (A2:9) (37°)	Inlet	80	77	75	75	75	76	75	71	85
HC 80 T6 (A2:9) (40°)	Inlet	81	78	76	74	75	76	75	71	85
HC 80 T6 (A2:9) (43°)	Inlet	81	78	76	74	74	75	74	70	85
HC 80 T6 (A2:9) (45°)	Inlet	80	78	77	74	74	74	74	70	85
HC 80 T6 (A5:6) (20°)	Inlet	71	78	83	85	85	83	82	75	91
HC 80 T6 (A5:6) (25°)	Inlet	58	65	71	76	78	78	79	71	84
HC 80 T6 (A5:6) (30°)	Inlet	58	69	76	86	84	82	82	74	90
HC 80 T6 (A5:6) (35°)	Inlet	55	67	73	81	86	84	84	75	90
HC 80 T6 (A5:6) (40°)	Inlet	56	69	85	90	87	83	81	73	93
HC 80 T6 (A5:6) (45°)	Inlet	56	70	93	96	87	82	79	71	98
HC 90 T6 (A6:3) (20°)	Inlet	77	70	72	68	70	70	73	69	81
HC 90 T6 (A6:3) (22°)	Inlet	78	72	73	70	71	71	74	70	82
HC 90 T6 (A6:3) (24°)	Inlet	79	73	74	72	73	73	75	71	84
HC 90 T6 (A6:3) (26°)	Inlet	80	75	75	74	74	74	76	72	85
HC 90 T6 (A6:3) (28°)	Inlet	81	76	76	76	75	75	77	73	86
HC 90 T6 (A6:3) (30°)	Inlet	82	77	77	78	76	76	78	74	87
HC 90 T6 (A6:3) (32°)	Inlet	82	78	78	79	77	77	78	74	87
HC 90 T6 (A6:3) (34°)	Inlet	82	78	78	80	77	77	78	75	88
HC 90 T6 (A6:3) (36°)	Inlet	82	79	79	81	78	78	79	75	88

Sound power Lw dB (A)										
Model		63 Hz	125 Hz	250 Hz	500 Hz	1000 Hz	2000 Hz	4000 Hz	8000 Hz	Total
HC 90 T6 (A6:3) (38°)	Inlet	83	80	80	82	79	79	80	76	89
HC 90 T6 (A6:3) (40°)	Inlet	83	81	81	83	80	81	81	77	90
HC 90 T6 (A6:3) (42°)	Inlet	83	82	81	83	81	82	81	78	91
HC 90 T6 (A6:6) (20°)	Inlet	82	81	80	82	83	80	80	78	90
HC 90 T6 (A6:6) (22°)	Inlet	82	82	81	82	83	80	81	78	90
HC 90 T6 (A6:6) (24°)	Inlet	83	83	82	83	83	81	82	79	91
HC 90 T6 (A6:6) (26°)	Inlet	84	83	82	83	83	81	82	79	91
HC 90 T6 (A6:6) (28°)	Inlet	85	84	82	84	83	81	83	80	92
HC 90 T6 (A6:6) (30°)	Inlet	85	84	83	84	82	81	83	80	92
HC 90 T6 (A6:6) (32°)	Inlet	84	83	81	82	80	80	82	78	91
HC 90 T6 (A6:6) (34°)	Inlet	83	82	80	80	79	79	80	77	89
HC 90 T6 (A6:6) (36°)	Inlet	83	81	79	80	78	78	80	76	89
HC 90 T6 (A6:6) (38°)	Inlet	83	82	80	81	79	79	80	77	90
HC 90 T6 (A6:6) (40°)	Inlet	84	83	81	81	79	79	81	77	90
HC 90 T6 (A6:6) (42°)	Inlet	84	84	82	82	80	80	81	77	91
HC 100 T6 (A6:3) (20°)	Inlet	81	78	76	75	77	78	81	76	87
HC 100 T6 (A6:3) (22°)	Inlet	82	79	77	76	78	78	82	76	88
HC 100 T6 (A6:3) (24°)	Inlet	82	79	77	77	78	78	81	76	88
HC 100 T6 (A6:3) (26°)	Inlet	82	79	77	77	77	78	80	76	88
HC 100 T6 (A6:3) (28°)	Inlet	82	79	77	77	77	77	79	75	87
HC 100 T6 (A6:3) (30°)	Inlet	82	79	77	77	77	77	79	75	87
HC 100 T6 (A6:3) (32°)	Inlet	84	80	79	79	78	78	79	76	89
HC 100 T6 (A6:3) (34°)	Inlet	86	81	81	81	79	79	80	77	90
HC 100 T6 (A6:3) (36°)	Inlet	86	82	82	82	80	80	80	77	91
HC 100 T6 (A6:3) (38°)	Inlet	86	83	82	82	81	81	81	78	91
HC 100 T6 (A6:3) (40°)	Inlet	86	83	82	83	82	81	82	79	92
HC 100 T6 (A6:3) (42°)	Inlet	86	84	82	84	83	82	82	79	92
HC 100 T6 (A6:6) (20°)	Inlet	85	86	84	89	87	85	85	83	95
HC 100 T6 (A6:6) (22°)	Inlet	86	86	84	88	86	84	85	82	95
HC 100 T6 (A6:6) (24°)	Inlet	86	86	85	88	86	84	85	82	95
HC 100 T6 (A6:6) (26°)	Inlet	88	87	86	88	86	85	85	83	95
HC 100 T6 (A6:6) (28°)	Inlet	89	88	87	88	86	85	86	83	96
HC 100 T6 (A6:6) (30°)	Inlet	90	88	87	88	86	85	86	83	96
HC 100 T6 (A6:6) (32°)	Inlet	89	87	86	86	84	84	85	82	95
HC 100 T6 (A6:6) (34°)	Inlet	88	86	85	84	83	82	84	81	94
HC 100 T6 (A6:6) (36°)	Inlet	88	86	85	83	82	82	83	80	93
HC 100 T6 (A6:6) (38°)	Inlet	89	87	85	84	83	83	84	80	94
HC 100 T6 (A6:6) (40°)	Inlet	89	87	86	85	84	84	85	81	95
HC 100 T6 (A6:6) (42°)	Inlet	89	87	86	85	84	83	84	81	95

Sound power Lw dB (A)										
Model		63 Hz	125 Hz	250 Hz	500 Hz	1000 Hz	2000 Hz	4000 Hz	8000 Hz	Total
HC 112 T6 (A6:3) (20º)	Inlet	84	81	79	80	82	82	84	81	91
HC 112 T6 (A6:3) (22º)	Inlet	85	82	80	81	82	82	84	81	92
HC 112 T6 (A6:3) (24º)	Inlet	86	83	81	82	83	83	85	82	93
HC 112 T6 (A6:3) (26º)	Inlet	87	84	82	82	83	83	85	82	93
HC 112 T6 (A6:3) (28º)	Inlet	88	84	83	83	83	83	85	82	93
HC 112 T6 (A6:3) (30º)	Inlet	88	83	83	83	82	82	84	81	93
HC 112 T6 (A6:3) (32º)	Inlet	89	84	84	83	82	82	84	81	93
HC 112 T6 (A6:3) (34º)	Inlet	89	84	84	83	83	82	84	81	94
HC 112 T6 (A6:3) (36º)	Inlet	89	84	85	84	83	82	84	81	94
HC 112 T6 (A6:3) (38º)	Inlet	90	85	85	84	83	83	84	82	94
HC 112 T6 (A6:3) (40º)	Inlet	89	85	84	85	84	83	84	81	94
HC 112 T6 (A6:3) (42º)	Inlet	89	86	84	85	84	84	84	82	95
HC 112 T6 (A6:6) (20º)	Inlet	86	87	85	91	89	86	88	85	96
HC 112 T6 (A6:6) (22º)	Inlet	87	87	86	90	88	86	87	84	96
HC 112 T6 (A6:6) (24º)	Inlet	87	87	85	89	87	86	87	83	96
HC 112 T6 (A6:6) (26º)	Inlet	89	88	86	89	87	86	87	83	96
HC 112 T6 (A6:6) (28º)	Inlet	91	88	86	89	87	87	88	83	97
HC 112 T6 (A6:6) (30º)	Inlet	91	88	86	88	87	87	87	83	97
HC 112 T6 (A6:6) (32º)	Inlet	91	88	86	86	85	86	87	82	96
HC 112 T6 (A6:6) (34º)	Inlet	91	88	86	84	84	85	86	81	95
HC 112 T6 (A6:6) (36º)	Inlet	91	88	86	84	85	85	86	81	96
HC 112 T6 (A6:6) (38º)	Inlet	93	90	88	86	86	86	87	82	97
HC 112 T6 (A6:6) (40º)	Inlet	95	91	90	88	88	88	88	84	99
HC 112 T6 (A6:6) (42º)	Inlet	95	91	90	88	87	87	88	83	99
HC 125 T6 (A7:4) (20º)	Inlet	88	92	90	91	92	91	93	92	101
HC 125 T6 (A7:4) (22º)	Inlet	91	93	91	92	92	92	94	92	102
HC 125 T6 (A7:4) (24º)	Inlet	92	91	89	90	90	90	92	90	100
HC 125 T6 (A7:4) (26º)	Inlet	92	90	88	88	88	89	90	87	98
HC 125 T6 (A7:4) (28º)	Inlet	92	89	87	86	87	87	88	85	97
HC 125 T6 (A7:4) (30º)	Inlet	90	87	85	84	85	85	86	82	95
HC 125 T6 (A7:4) (32º)	Inlet	90	87	85	84	84	85	86	81	95
HC 125 T6 (A7:4) (34º)	Inlet	90	87	85	83	84	84	85	80	95
HC 125 T6 (A7:4) (36º)	Inlet	90	87	85	84	84	85	85	80	95
HC 125 T6 (A7:4) (38º)	Inlet	91	88	86	85	85	86	86	81	96
HC 125 T6 (A7:4) (40º)	Inlet	92	89	87	85	85	86	86	81	96
HC 125 T6 (A7:4) (42º)	Inlet	92	89	87	86	85	87	86	82	97
HC 125 T6 (A7:8) (20º)	Inlet	94	92	91	94	98	99	98	95	106
HC 125 T6 (A7:8) (22º)	Inlet	94	92	91	93	96	98	98	94	105
HC 125 T6 (A7:8) (24º)	Inlet	94	91	90	92	95	96	96	92	103

Sound power Lw dB (A)										
Model		63 Hz	125 Hz	250 Hz	500 Hz	1000 Hz	2000 Hz	4000 Hz	8000 Hz	Total
HC 125 T6 (A7:8) (26°)	Inlet	94	90	90	91	94	95	95	91	102
HC 125 T6 (A7:8) (28°)	Inlet	94	90	89	90	92	94	94	90	102
HC 125 T6 (A7:8) (30°)	Inlet	93	89	89	88	91	92	92	88	100
HC 125 T6 (A7:8) (32°)	Inlet	94	89	89	88	89	91	91	86	99
HC 125 T6 (A7:8) (34°)	Inlet	94	90	89	88	88	89	89	84	99
HC 125 T6 (A7:8) (36°)	Inlet	94	91	89	88	88	89	88	83	99
HC 125 T6 (A7:8) (38°)	Inlet	94	91	89	88	88	89	88	83	99
HC 125 T6 (A7:8) (40°)	Inlet	94	91	89	87	87	88	87	83	98
HC 125 T6 (A7:8) (42°)	Inlet	93	90	88	87	87	88	86	82	98

Sound / 4/8 poles

Sound power Lw dB (A)										
Model		63 Hz	125 Hz	250 Hz	500 Hz	1000 Hz	2000 Hz	4000 Hz	8000 Hz	Total
HC 35 T4/T8 (A0:6) (750 RPM - 35°)	Inlet	50	47	46	44	44	43	45	41	55
HC 35 T4/T8 (A0:6) (750 RPM - 40°)	Inlet	51	49	48	46	45	45	46	42	56
HC 35 T4/T8 (A0:6) (1500 RPM - 35°)	Inlet	65	63	62	60	60	59	61	57	71
HC 35 T4/T8 (A0:6) (1500 RPM - 40°)	Inlet	67	65	64	62	61	61	62	58	72
HC 40 T4/T8 (A0:6) (750 RPM - 35°)	Inlet	53	50	48	46	47	47	48	43	58
HC 40 T4/T8 (A0:6) (750 RPM - 40°)	Inlet	57	53	52	50	50	50	50	46	61
HC 40 T4/T8 (A0:6) (1500 RPM - 35°)	Inlet	69	66	64	62	63	63	64	59	74
HC 40 T4/T8 (A0:6) (1500 RPM - 40°)	Inlet	73	69	68	66	66	66	66	62	77
HC 45 T4/T8 (A0:6) (750 RPM - 35°)	Inlet	55	52	50	49	49	49	51	46	60
HC 45 T4/T8 (A0:6) (750 RPM - 40°)	Inlet	57	54	52	51	51	50	51	46	62
HC 45 T4/T8 (A0:6) (1500 RPM - 35°)	Inlet	71	68	66	65	65	64	66	62	76
HC 45 T4/T8 (A0:6) (1500 RPM - 40°)	Inlet	73	70	68	67	66	66	67	62	78
HC 45 T4/T8 (A5:6) (750 RPM - 25°)	Inlet	29	34	41	48	47	48	50	43	55
HC 45 T4/T8 (A5:6) (750 RPM - 30°)	Inlet	32	37	44	48	50	51	52	43	57

Sound power Lw dB (A)										
Model		63 Hz	125 Hz	250 Hz	500 Hz	1000 Hz	2000 Hz	4000 Hz	8000 Hz	Total
HC 45 T4/T8 (A5:6) (750 RPM - 35°)	Inlet	34	38	46	47	52	52	53	43	58
HC 45 T4/T8 (A5:6) (750 RPM - 40°)	Inlet	37	40	49	50	54	54	55	46	60
HC 45 T4/T8 (A5:6) (750 RPM - 45°)	Inlet	36	40	48	51	55	55	56	48	61
HC 45 T4/T8 (A5:6) (1500 RPM - 25°)	Inlet	45	50	57	64	63	64	66	59	71
HC 45 T4/T8 (A5:6) (1500 RPM - 30°)	Inlet	48	53	60	64	66	67	68	59	73
HC 45 T4/T8 (A5:6) (1500 RPM - 35°)	Inlet	50	54	62	63	68	68	69	59	74
HC 45 T4/T8 (A5:6) (1500 RPM - 40°)	Inlet	53	56	65	66	70	70	71	62	76
HC 45 T4/T8 (A5:6) (1500 RPM - 45°)	Inlet	52	56	64	67	71	71	72	64	77
HC 50 T4/T8 (A0:6) (750 RPM - 35°)	Inlet	56	53	53	50	50	48	50	45	61
HC 50 T4/T8 (A0:6) (750 RPM - 40°)	Inlet	59	56	54	53	53	51	52	47	63
HC 50 T4/T8 (A0:6) (1500 RPM - 35°)	Inlet	72	69	69	66	66	64	66	61	77
HC 50 T4/T8 (A0:6) (1500 RPM - 40°)	Inlet	75	72	70	68	69	67	68	63	79
HC 50 T4/T8 (A5:6) (750 RPM - 25°)	Inlet	29	35	41	45	48	50	52	44	56
HC 50 T4/T8 (A5:6) (750 RPM - 30°)	Inlet	31	37	43	47	51	51	55	46	58
HC 50 T4/T8 (A5:6) (750 RPM - 35°)	Inlet	33	38	45	51	53	54	56	47	61
HC 50 T4/T8 (A5:6) (750 RPM - 40°)	Inlet	34	41	46	51	53	54	57	48	61
HC 50 T4/T8 (A5:6) (750 RPM - 45°)	Inlet	37	44	49	56	57	57	59	52	64
HC 50 T4/T8 (A5:6) (1500 RPM - 25°)	Inlet	44	51	56	61	64	66	68	60	72
HC 50 T4/T8 (A5:6) (1500 RPM - 30°)	Inlet	47	52	59	63	66	67	70	61	74
HC 50 T4/T8 (A5:6) (1500 RPM - 35°)	Inlet	49	54	61	67	69	70	72	63	77
HC 50 T4/T8 (A5:6) (1500 RPM - 40°)	Inlet	49	56	61	67	69	70	72	63	77
HC 50 T4/T8 (A5:6) (1500 RPM - 45°)	Inlet	52	59	64	72	73	73	75	67	80

Sound power Lw dB (A)										
Model		63 Hz	125 Hz	250 Hz	500 Hz	1000 Hz	2000 Hz	4000 Hz	8000 Hz	Total
HC 56 T4/T8 (A2:6) (750 RPM - 20°)	Inlet	56	54	57	60	59	58	59	57	67
HC 56 T4/T8 (A2:6) (750 RPM - 25°)	Inlet	60	58	59	60	59	59	60	57	68
HC 56 T4/T8 (A2:6) (750 RPM - 27°)	Inlet	60	58	58	60	59	58	60	56	68
HC 56 T4/T8 (A2:6) (750 RPM - 30°)	Inlet	62	59	58	58	57	57	59	55	67
HC 56 T4/T8 (A2:6) (750 RPM - 33°)	Inlet	63	60	58	58	57	58	59	55	68
HC 56 T4/T8 (A2:6) (750 RPM - 35°)	Inlet	62	59	57	58	57	58	59	55	68
HC 56 T4/T8 (A2:6) (750 RPM - 37°)	Inlet	63	60	58	58	57	58	59	55	68
HC 56 T4/T8 (A2:6) (750 RPM - 40°)	Inlet	64	61	59	59	58	59	59	55	69
HC 56 T4/T8 (A2:6) (750 RPM - 43°)	Inlet	66	60	61	59	59	59	59	55	70
HC 56 T4/T8 (A2:6) (750 RPM - 45°)	Inlet	66	60	61	59	59	60	59	56	70
HC 56 T4/T8 (A2:6) (1500 RPM - 20°)	Inlet	72	70	73	76	75	74	75	73	83
HC 56 T4/T8 (A2:6) (1500 RPM - 25°)	Inlet	76	73	74	76	75	75	76	73	84
HC 56 T4/T8 (A2:6) (1500 RPM - 27°)	Inlet	76	74	74	76	74	74	75	72	84
HC 56 T4/T8 (A2:6) (1500 RPM - 30°)	Inlet	78	75	74	74	73	73	75	71	83
HC 56 T4/T8 (A2:6) (1500 RPM - 33°)	Inlet	79	76	74	74	73	74	74	71	84
HC 56 T4/T8 (A2:6) (1500 RPM - 35°)	Inlet	78	75	73	74	73	74	74	71	84
HC 56 T4/T8 (A2:6) (1500 RPM - 37°)	Inlet	79	76	74	74	73	74	75	71	84
HC 56 T4/T8 (A2:6) (1500 RPM - 40°)	Inlet	80	77	75	74	74	74	75	71	85
HC 56 T4/T8 (A2:6) (1500 RPM - 43°)	Inlet	81	76	76	75	75	75	75	71	86
HC 56 T4/T8 (A2:6) (1500 RPM - 45°)	Inlet	82	76	77	75	75	76	75	72	86
HC 56 T4/T8 (A2:9) (750 RPM - 20°)	Inlet	64	58	60	61	60	59	60	54	69
HC 56 T4/T8 (A2:9) (750 RPM - 25°)	Inlet	63	58	60	60	60	59	60	56	69

Sound power Lw dB (A)										
Model		63 Hz	125 Hz	250 Hz	500 Hz	1000 Hz	2000 Hz	4000 Hz	8000 Hz	Total
HC 56 T4/T8 (A2:9) (750 RPM - 27°)	Inlet	64	59	60	60	60	60	61	56	69
HC 56 T4/T8 (A2:9) (750 RPM - 30°)	Inlet	64	59	60	60	61	60	61	58	70
HC 56 T4/T8 (A2:9) (750 RPM - 33°)	Inlet	63	59	61	60	61	60	62	58	70
HC 56 T4/T8 (A2:9) (750 RPM - 35°)	Inlet	63	59	61	60	60	60	62	58	70
HC 56 T4/T8 (A2:9) (750 RPM - 37°)	Inlet	63	59	61	60	60	60	61	58	70
HC 56 T4/T8 (A2:9) (750 RPM - 40°)	Inlet	63	60	62	60	60	60	61	57	70
HC 56 T4/T8 (A2:9) (750 RPM - 43°)	Inlet	63	60	63	60	60	60	61	58	70
HC 56 T4/T8 (A2:9) (750 RPM - 45°)	Inlet	64	60	64	60	60	60	61	58	70
HC 56 T4/T8 (A2:9) (1500 RPM - 20°)	Inlet	80	74	76	76	76	75	76	70	85
HC 56 T4/T8 (A2:9) (1500 RPM - 25°)	Inlet	79	74	76	76	76	75	76	72	85
HC 56 T4/T8 (A2:9) (1500 RPM - 27°)	Inlet	80	75	76	76	76	75	76	72	85
HC 56 T4/T8 (A2:9) (1500 RPM - 30°)	Inlet	80	75	76	76	77	76	77	74	86
HC 56 T4/T8 (A2:9) (1500 RPM - 33°)	Inlet	79	75	77	76	76	76	77	74	86
HC 56 T4/T8 (A2:9) (1500 RPM - 35°)	Inlet	79	75	77	76	76	76	78	74	86
HC 56 T4/T8 (A2:9) (1500 RPM - 37°)	Inlet	79	75	77	76	76	76	77	74	86
HC 56 T4/T8 (A2:9) (1500 RPM - 40°)	Inlet	79	76	78	76	76	76	77	73	86
HC 56 T4/T8 (A2:9) (1500 RPM - 43°)	Inlet	79	76	79	76	76	76	77	73	86
HC 56 T4/T8 (A2:9) (1500 RPM - 45°)	Inlet	80	76	80	76	76	76	77	74	86
HC 56 T4/T8 (A5:6) (750 RPM - 20°)	Inlet	50	57	62	63	64	62	60	52	70
HC 56 T4/T8 (A5:6) (750 RPM - 25°)	Inlet	37	46	51	57	59	59	60	51	66
HC 56 T4/T8 (A5:6) (750 RPM - 30°)	Inlet	46	56	63	65	65	63	61	53	71
HC 56 T4/T8 (A5:6) (750 RPM - 35°)	Inlet	34	46	51	57	58	59	60	52	65

Sound power Lw dB (A)										
Model		63 Hz	125 Hz	250 Hz	500 Hz	1000 Hz	2000 Hz	4000 Hz	8000 Hz	Total
HC 56 T4/T8 (A5:6) (750 RPM - 40°)	Inlet	40	53	63	69	68	62	60	51	73
HC 56 T4/T8 (A5:6) (750 RPM - 45°)	Inlet	45	57	72	78	75	64	60	51	81
HC 56 T4/T8 (A5:6) (1500 RPM - 20°)	Inlet	66	73	78	79	80	78	76	68	86
HC 56 T4/T8 (A5:6) (1500 RPM - 25°)	Inlet	53	62	67	73	75	75	76	67	82
HC 56 T4/T8 (A5:6) (1500 RPM - 30°)	Inlet	62	72	79	81	81	79	77	69	87
HC 56 T4/T8 (A5:6) (1500 RPM - 35°)	Inlet	50	62	67	73	74	75	76	68	81
HC 56 T4/T8 (A5:6) (1500 RPM - 40°)	Inlet	56	69	79	85	84	78	76	67	89
HC 56 T4/T8 (A5:6) (1500 RPM - 45°)	Inlet	60	73	88	94	91	80	76	67	96
HC 63 T4/T8 (A2:6) (750 RPM - 20°)	Inlet	59	52	57	61	58	56	58	55	67
HC 63 T4/T8 (A2:6) (750 RPM - 25°)	Inlet	63	58	60	62	60	60	61	58	70
HC 63 T4/T8 (A2:6) (750 RPM - 27°)	Inlet	63	58	60	62	60	60	61	58	70
HC 63 T4/T8 (A2:6) (750 RPM - 30°)	Inlet	63	60	60	61	60	60	61	58	70
HC 63 T4/T8 (A2:6) (750 RPM - 33°)	Inlet	63	61	59	60	59	60	61	57	69
HC 63 T4/T8 (A2:6) (750 RPM - 35°)	Inlet	63	60	58	59	58	60	60	57	69
HC 63 T4/T8 (A2:6) (750 RPM - 37°)	Inlet	64	61	59	60	59	60	60	57	70
HC 63 T4/T8 (A2:6) (750 RPM - 40°)	Inlet	66	62	61	61	60	61	61	57	70
HC 63 T4/T8 (A2:6) (750 RPM - 43°)	Inlet	68	62	63	61	61	61	61	57	72
HC 63 T4/T8 (A2:6) (750 RPM - 45°)	Inlet	68	62	63	62	62	61	61	57	72
HC 63 T4/T8 (A2:6) (1500 RPM - 20°)	Inlet	75	67	73	77	73	72	74	71	82
HC 63 T4/T8 (A2:6) (1500 RPM - 25°)	Inlet	79	74	76	78	76	76	77	74	86
HC 63 T4/T8 (A2:6) (1500 RPM - 27°)	Inlet	79	74	76	78	76	76	77	74	86
HC 63 T4/T8 (A2:6) (1500 RPM - 30°)	Inlet	79	76	75	77	75	76	77	74	85

Sound power Lw dB (A)										
Model		63 Hz	125 Hz	250 Hz	500 Hz	1000 Hz	2000 Hz	4000 Hz	8000 Hz	Total
HC 63 T4/T8 (A2:6) (1500 RPM - 33°)	Inlet	79	77	75	76	75	76	76	73	85
HC 63 T4/T8 (A2:6) (1500 RPM - 35°)	Inlet	79	76	74	75	74	76	76	73	85
HC 63 T4/T8 (A2:6) (1500 RPM - 37°)	Inlet	80	77	75	76	75	76	76	73	86
HC 63 T4/T8 (A2:6) (1500 RPM - 40°)	Inlet	81	78	76	76	76	76	76	73	86
HC 63 T4/T8 (A2:6) (1500 RPM - 43°)	Inlet	83	78	78	77	77	77	77	73	88
HC 63 T4/T8 (A2:6) (1500 RPM - 45°)	Inlet	84	78	79	77	78	77	77	73	88
HC 63 T4/T8 (A2:9) (750 RPM - 20°)	Inlet	67	60	64	64	63	61	62	59	72
HC 63 T4/T8 (A2:9) (750 RPM - 25°)	Inlet	67	61	63	63	62	61	63	59	72
HC 63 T4/T8 (A2:9) (750 RPM - 27°)	Inlet	67	61	63	63	62	62	63	60	72
HC 63 T4/T8 (A2:9) (750 RPM - 30°)	Inlet	68	63	63	64	62	63	64	61	73
HC 63 T4/T8 (A2:9) (750 RPM - 33°)	Inlet	67	63	63	64	63	63	64	61	73
HC 63 T4/T8 (A2:9) (750 RPM - 35°)	Inlet	67	63	63	64	63	63	64	61	73
HC 63 T4/T8 (A2:9) (750 RPM - 37°)	Inlet	67	63	63	63	63	63	64	61	73
HC 63 T4/T8 (A2:9) (750 RPM - 40°)	Inlet	67	64	62	63	63	63	64	61	73
HC 63 T4/T8 (A2:9) (750 RPM - 43°)	Inlet	67	64	62	63	63	63	64	60	73
HC 63 T4/T8 (A2:9) (750 RPM - 45°)	Inlet	67	64	62	63	63	63	64	60	73
HC 63 T4/T8 (A2:9) (1500 RPM - 20°)	Inlet	83	76	80	80	78	76	78	75	88
HC 63 T4/T8 (A2:9) (1500 RPM - 25°)	Inlet	83	77	79	79	78	77	79	75	88
HC 63 T4/T8 (A2:9) (1500 RPM - 27°)	Inlet	83	77	79	79	78	78	79	76	88
HC 63 T4/T8 (A2:9) (1500 RPM - 30°)	Inlet	84	79	79	79	78	79	80	76	89
HC 63 T4/T8 (A2:9) (1500 RPM - 33°)	Inlet	83	79	79	80	79	79	80	76	89
HC 63 T4/T8 (A2:9) (1500 RPM - 35°)	Inlet	83	79	79	80	79	79	80	77	89

Sound power Lw dB (A)										
Model		63 Hz	125 Hz	250 Hz	500 Hz	1000 Hz	2000 Hz	4000 Hz	8000 Hz	Total
HC 63 T4/T8 (A2:9) (1500 RPM - 37°)	Inlet	83	79	79	79	79	79	80	77	89
HC 63 T4/T8 (A2:9) (1500 RPM - 40°)	Inlet	83	79	78	79	79	79	79	77	89
HC 63 T4/T8 (A2:9) (1500 RPM - 43°)	Inlet	83	80	78	79	79	79	80	76	89
HC 63 T4/T8 (A2:9) (1500 RPM - 45°)	Inlet	83	80	78	79	78	79	80	76	88
HC 63 T4/T8 (A5:6) (750 RPM - 20°)	Inlet	53	60	65	66	67	64	63	56	73
HC 63 T4/T8 (A5:6) (750 RPM - 25°)	Inlet	39	48	53	58	62	61	61	54	67
HC 63 T4/T8 (A5:6) (750 RPM - 30°)	Inlet	41	49	59	66	64	63	63	56	71
HC 63 T4/T8 (A5:6) (750 RPM - 35°)	Inlet	37	49	54	58	62	61	63	56	68
HC 63 T4/T8 (A5:6) (750 RPM - 40°)	Inlet	38	50	62	73	70	65	63	55	76
HC 63 T4/T8 (A5:6) (750 RPM - 45°)	Inlet	39	50	67	84	76	68	63	55	85
HC 63 T4/T8 (A5:6) (1500 RPM - 20°)	Inlet	69	76	81	82	83	80	79	72	89
HC 63 T4/T8 (A5:6) (1500 RPM - 25°)	Inlet	54	63	68	73	77	76	76	70	83
HC 63 T4/T8 (A5:6) (1500 RPM - 30°)	Inlet	57	65	75	82	80	79	79	72	87
HC 63 T4/T8 (A5:6) (1500 RPM - 35°)	Inlet	53	65	70	74	78	77	79	72	84
HC 63 T4/T8 (A5:6) (1500 RPM - 40°)	Inlet	54	66	77	89	86	81	79	71	92
HC 63 T4/T8 (A5:6) (1500 RPM - 45°)	Inlet	55	66	82	100	92	84	79	71	100
HC 71 T4/T8 (A2:6) (750 RPM - 20°)	Inlet	65	61	65	66	67	65	67	63	74
HC 71 T4/T8 (A2:6) (750 RPM - 25°)	Inlet	67	63	64	66	65	65	66	63	74
HC 71 T4/T8 (A2:6) (750 RPM - 27°)	Inlet	67	63	64	65	65	64	66	62	74
HC 71 T4/T8 (A2:6) (750 RPM - 30°)	Inlet	68	64	63	65	63	64	65	62	74
HC 71 T4/T8 (A2:6) (750 RPM - 33°)	Inlet	67	64	62	63	62	63	64	60	73
HC 71 T4/T8 (A2:6) (750 RPM - 35°)	Inlet	67	64	62	62	61	63	63	59	72

Sound power Lw dB (A)										
Model		63 Hz	125 Hz	250 Hz	500 Hz	1000 Hz	2000 Hz	4000 Hz	8000 Hz	Total
HC 71 T4/T8 (A2:6) (750 RPM - 37°)	Inlet	68	65	63	63	63	63	63	59	73
HC 71 T4/T8 (A2:6) (750 RPM - 40°)	Inlet	69	66	64	64	64	64	63	59	74
HC 71 T4/T8 (A2:6) (750 RPM - 43°)	Inlet	71	66	66	64	64	64	64	59	75
HC 71 T4/T8 (A2:6) (750 RPM - 45°)	Inlet	72	66	67	64	64	64	64	59	75
HC 71 T4/T8 (A2:6) (1500 RPM - 20°)	Inlet	81	77	81	82	83	81	83	79	90
HC 71 T4/T8 (A2:6) (1500 RPM - 25°)	Inlet	83	79	80	82	81	81	82	78	90
HC 71 T4/T8 (A2:6) (1500 RPM - 27°)	Inlet	83	79	80	81	80	80	82	78	90
HC 71 T4/T8 (A2:6) (1500 RPM - 30°)	Inlet	84	80	79	81	79	80	81	78	90
HC 71 T4/T8 (A2:6) (1500 RPM - 33°)	Inlet	83	80	78	79	78	79	80	76	89
HC 71 T4/T8 (A2:6) (1500 RPM - 35°)	Inlet	83	80	78	78	77	78	79	75	88
HC 71 T4/T8 (A2:6) (1500 RPM - 37°)	Inlet	84	81	79	79	78	79	79	75	89
HC 71 T4/T8 (A2:6) (1500 RPM - 40°)	Inlet	85	82	80	80	80	80	79	75	90
HC 71 T4/T8 (A2:6) (1500 RPM - 43°)	Inlet	87	82	82	80	80	80	79	75	91
HC 71 T4/T8 (A2:6) (1500 RPM - 45°)	Inlet	88	82	83	80	80	80	80	75	91
HC 71 T4/T8 (A2:9) (750 RPM - 20°)	Inlet	70	67	69	70	69	68	70	65	78
HC 71 T4/T8 (A2:9) (750 RPM - 25°)	Inlet	70	67	67	68	68	67	68	64	77
HC 71 T4/T8 (A2:9) (750 RPM - 27°)	Inlet	70	67	66	68	67	66	68	64	76
HC 71 T4/T8 (A2:9) (750 RPM - 30°)	Inlet	70	67	65	66	66	66	67	63	76
HC 71 T4/T8 (A2:9) (750 RPM - 33°)	Inlet	70	67	65	66	66	66	67	63	76
HC 71 T4/T8 (A2:9) (750 RPM - 35°)	Inlet	70	67	65	66	66	67	66	63	76
HC 71 T4/T8 (A2:9) (750 RPM - 37°)	Inlet	71	68	66	66	66	67	66	63	76
HC 71 T4/T8 (A2:9) (750 RPM - 40°)	Inlet	72	68	67	66	66	67	67	63	76

Sound power Lw dB (A)										
Model		63 Hz	125 Hz	250 Hz	500 Hz	1000 Hz	2000 Hz	4000 Hz	8000 Hz	Total
HC 71 T4/T8 (A2:9) (750 RPM - 43°)	Inlet	71	68	66	66	66	66	66	62	76
HC 71 T4/T8 (A2:9) (750 RPM - 45°)	Inlet	70	68	66	66	65	66	66	61	75
HC 71 T4/T8 (A2:9) (1500 RPM - 20°)	Inlet	86	82	84	86	85	84	86	80	94
HC 71 T4/T8 (A2:9) (1500 RPM - 25°)	Inlet	86	83	83	84	83	83	84	80	93
HC 71 T4/T8 (A2:9) (1500 RPM - 27°)	Inlet	86	83	82	84	83	82	84	80	92
HC 71 T4/T8 (A2:9) (1500 RPM - 30°)	Inlet	86	83	81	82	82	82	83	79	92
HC 71 T4/T8 (A2:9) (1500 RPM - 33°)	Inlet	86	83	81	82	82	82	82	79	92
HC 71 T4/T8 (A2:9) (1500 RPM - 35°)	Inlet	86	83	81	82	82	82	82	79	91
HC 71 T4/T8 (A2:9) (1500 RPM - 37°)	Inlet	87	84	82	82	82	82	82	79	92
HC 71 T4/T8 (A2:9) (1500 RPM - 40°)	Inlet	87	84	82	81	82	82	82	79	92
HC 71 T4/T8 (A2:9) (1500 RPM - 43°)	Inlet	86	84	82	81	81	82	82	78	92
HC 71 T4/T8 (A2:9) (1500 RPM - 45°)	Inlet	86	84	82	81	81	81	81	77	91
HC 71 T4/T8 (A5:6) (750 RPM - 20°)	Inlet	56	63	68	70	70	68	67	60	76
HC 71 T4/T8 (A5:6) (750 RPM - 25°)	Inlet	43	52	58	62	65	66	66	57	72
HC 71 T4/T8 (A5:6) (750 RPM - 30°)	Inlet	44	53	59	65	66	66	65	56	72
HC 71 T4/T8 (A5:6) (750 RPM - 35°)	Inlet	37	49	54	59	62	63	64	55	69
HC 71 T4/T8 (A5:6) (750 RPM - 40°)	Inlet	41	52	67	76	72	68	66	56	79
HC 71 T4/T8 (A5:6) (750 RPM - 45°)	Inlet	45	54	76	89	80	71	67	56	90
HC 71 T4/T8 (A5:6) (1500 RPM - 20°)	Inlet	71	78	83	85	85	83	82	75	92
HC 71 T4/T8 (A5:6) (1500 RPM - 25°)	Inlet	58	68	74	78	81	82	82	73	88
HC 71 T4/T8 (A5:6) (1500 RPM - 30°)	Inlet	60	68	75	81	82	81	81	72	87
HC 71 T4/T8 (A5:6) (1500 RPM - 35°)	Inlet	53	65	70	75	78	79	80	71	84

Sound power Lw dB (A)										
Model		63 Hz	125 Hz	250 Hz	500 Hz	1000 Hz	2000 Hz	4000 Hz	8000 Hz	Total
HC 71 T4/T8 (A5:6) (1500 RPM - 40°)	Inlet	57	68	83	92	88	83	81	72	95
HC 71 T4/T8 (A5:6) (1500 RPM - 45°)	Inlet	61	70	92	105	96	87	83	72	105
HC 80 T4/T8 (A2:6) (750 RPM - 20°)	Inlet	64	61	64	67	67	66	67	65	75
HC 80 T4/T8 (A2:6) (750 RPM - 25°)	Inlet	68	65	65	66	67	66	68	64	75
HC 80 T4/T8 (A2:6) (750 RPM - 27°)	Inlet	69	65	65	66	66	67	68	64	75
HC 80 T4/T8 (A2:6) (750 RPM - 30°)	Inlet	70	67	65	66	66	67	67	63	76
HC 80 T4/T8 (A2:6) (750 RPM - 33°)	Inlet	71	68	66	66	66	67	67	63	76
HC 80 T4/T8 (A2:6) (750 RPM - 35°)	Inlet	72	69	67	66	66	67	67	62	77
HC 80 T4/T8 (A2:6) (750 RPM - 37°)	Inlet	72	69	67	65	65	66	66	61	77
HC 80 T4/T8 (A2:6) (750 RPM - 40°)	Inlet	72	69	67	65	65	65	65	60	76
HC 80 T4/T8 (A2:6) (750 RPM - 43°)	Inlet	72	70	68	66	66	65	65	60	77
HC 80 T4/T8 (A2:6) (750 RPM - 45°)	Inlet	72	70	69	66	66	65	65	60	77
HC 80 T4/T8 (A2:6) (1500 RPM - 20°)	Inlet	80	77	80	82	83	82	83	80	90
HC 80 T4/T8 (A2:6) (1500 RPM - 25°)	Inlet	83	80	81	82	83	82	83	80	91
HC 80 T4/T8 (A2:6) (1500 RPM - 27°)	Inlet	84	81	81	82	82	82	83	80	91
HC 80 T4/T8 (A2:6) (1500 RPM - 30°)	Inlet	86	83	81	82	82	83	83	79	92
HC 80 T4/T8 (A2:6) (1500 RPM - 33°)	Inlet	87	84	82	82	82	83	83	78	92
HC 80 T4/T8 (A2:6) (1500 RPM - 35°)	Inlet	88	85	83	81	81	83	83	78	92
HC 80 T4/T8 (A2:6) (1500 RPM - 37°)	Inlet	88	85	83	81	81	82	82	77	92
HC 80 T4/T8 (A2:6) (1500 RPM - 40°)	Inlet	87	85	83	81	81	81	81	76	92
HC 80 T4/T8 (A2:6) (1500 RPM - 43°)	Inlet	88	85	84	82	82	81	81	76	93
HC 80 T4/T8 (A2:6) (1500 RPM - 45°)	Inlet	88	85	84	82	82	81	81	76	93

Sound power Lw dB (A)										
Model		63 Hz	125 Hz	250 Hz	500 Hz	1000 Hz	2000 Hz	4000 Hz	8000 Hz	Total
HC 80 T4/T8 (A2:9) (750 RPM - 20°)	Inlet	70	72	70	76	75	73	75	69	82
HC 80 T4/T8 (A2:9) (750 RPM - 25°)	Inlet	72	71	69	74	73	71	73	68	81
HC 80 T4/T8 (A2:9) (750 RPM - 27°)	Inlet	73	71	69	73	72	71	73	68	81
HC 80 T4/T8 (A2:9) (750 RPM - 30°)	Inlet	74	71	69	71	71	71	71	67	80
HC 80 T4/T8 (A2:9) (750 RPM - 33°)	Inlet	73	70	68	70	70	70	70	66	79
HC 80 T4/T8 (A2:9) (750 RPM - 35°)	Inlet	73	70	68	68	69	70	69	65	78
HC 80 T4/T8 (A2:9) (750 RPM - 37°)	Inlet	73	70	68	68	69	70	69	65	79
HC 80 T4/T8 (A2:9) (750 RPM - 40°)	Inlet	74	71	69	68	68	69	69	64	79
HC 80 T4/T8 (A2:9) (750 RPM - 43°)	Inlet	74	72	70	68	68	68	68	64	79
HC 80 T4/T8 (A2:9) (750 RPM - 45°)	Inlet	74	71	70	68	68	68	67	63	79
HC 80 T4/T8 (A2:9) (1500 RPM - 20°)	Inlet	86	88	86	92	91	88	91	85	98
HC 80 T4/T8 (A2:9) (1500 RPM - 25°)	Inlet	88	87	85	90	89	87	89	84	97
HC 80 T4/T8 (A2:9) (1500 RPM - 27°)	Inlet	88	87	85	89	88	87	88	84	96
HC 80 T4/T8 (A2:9) (1500 RPM - 30°)	Inlet	89	86	84	87	87	87	87	83	96
HC 80 T4/T8 (A2:9) (1500 RPM - 33°)	Inlet	89	86	84	86	86	86	86	82	95
HC 80 T4/T8 (A2:9) (1500 RPM - 35°)	Inlet	88	85	83	84	85	86	85	81	94
HC 80 T4/T8 (A2:9) (1500 RPM - 37°)	Inlet	89	86	84	84	85	86	85	81	95
HC 80 T4/T8 (A2:9) (1500 RPM - 40°)	Inlet	90	87	85	84	84	85	85	80	95
HC 80 T4/T8 (A2:9) (1500 RPM - 43°)	Inlet	90	88	86	84	84	84	83	79	95
HC 80 T4/T8 (A2:9) (1500 RPM - 45°)	Inlet	90	87	86	84	84	84	83	79	95
HC 80 T4/T8 (A5:6) (750 RPM - 20°)	Inlet	58	65	70	72	72	70	69	62	79
HC 80 T4/T8 (A5:6) (750 RPM - 25°)	Inlet	45	52	58	63	65	65	66	58	72

Sound power Lw dB (A)										
Model		63 Hz	125 Hz	250 Hz	500 Hz	1000 Hz	2000 Hz	4000 Hz	8000 Hz	Total
HC 80 T4/T8 (A5:6) (750 RPM - 30°)	Inlet	45	57	64	73	71	69	69	61	78
HC 80 T4/T8 (A5:6) (750 RPM - 35°)	Inlet	42	54	60	68	73	71	71	62	78
HC 80 T4/T8 (A5:6) (750 RPM - 40°)	Inlet	43	56	72	77	74	70	68	60	81
HC 80 T4/T8 (A5:6) (750 RPM - 45°)	Inlet	44	58	81	84	75	70	66	59	86
HC 80 T4/T8 (A5:6) (1500 RPM - 20°)	Inlet	74	81	86	88	88	86	85	78	94
HC 80 T4/T8 (A5:6) (1500 RPM - 25°)	Inlet	61	68	74	79	81	81	82	74	88
HC 80 T4/T8 (A5:6) (1500 RPM - 30°)	Inlet	61	72	79	89	87	85	85	77	93
HC 80 T4/T8 (A5:6) (1500 RPM - 35°)	Inlet	58	70	76	84	89	87	87	78	94
HC 80 T4/T8 (A5:6) (1500 RPM - 40°)	Inlet	59	72	88	93	90	86	84	76	97
HC 80 T4/T8 (A5:6) (1500 RPM - 45°)	Inlet	60	74	97	100	91	86	82	75	102
HC 90 T4/T8 (A6:3) (750 RPM - 20°)	Inlet	70	64	65	62	63	64	67	63	74
HC 90 T4/T8 (A6:3) (750 RPM - 22°)	Inlet	71	65	66	64	65	65	68	64	76
HC 90 T4/T8 (A6:3) (750 RPM - 24°)	Inlet	73	67	68	66	66	66	69	65	77
HC 90 T4/T8 (A6:3) (750 RPM - 26°)	Inlet	73	68	69	68	67	67	70	66	78
HC 90 T4/T8 (A6:3) (750 RPM - 28°)	Inlet	74	70	70	70	68	68	70	67	79
HC 90 T4/T8 (A6:3) (750 RPM - 30°)	Inlet	75	71	71	71	70	70	71	67	80
HC 90 T4/T8 (A6:3) (750 RPM - 32°)	Inlet	75	71	71	73	70	70	72	68	81
HC 90 T4/T8 (A6:3) (750 RPM - 34°)	Inlet	76	72	72	74	71	71	72	68	81
HC 90 T4/T8 (A6:3) (750 RPM - 36°)	Inlet	76	73	72	75	72	72	72	69	82
HC 90 T4/T8 (A6:3) (750 RPM - 38°)	Inlet	76	74	73	76	73	73	73	70	83
HC 90 T4/T8 (A6:3) (750 RPM - 40°)	Inlet	76	74	74	77	74	74	74	71	84
HC 90 T4/T8 (A6:3) (750 RPM - 42°)	Inlet	77	75	75	77	75	75	75	72	85

Sound power Lw dB (A)										
Model		63 Hz	125 Hz	250 Hz	500 Hz	1000 Hz	2000 Hz	4000 Hz	8000 Hz	Total
HC 90 T4/T8 (A6:3) (1500 RPM - 20°)	Inlet	86	79	81	78	79	79	83	79	90
HC 90 T4/T8 (A6:3) (1500 RPM - 22°)	Inlet	87	81	82	80	81	81	84	80	92
HC 90 T4/T8 (A6:3) (1500 RPM - 24°)	Inlet	88	83	84	82	82	82	85	81	93
HC 90 T4/T8 (A6:3) (1500 RPM - 26°)	Inlet	89	84	85	84	83	83	86	82	94
HC 90 T4/T8 (A6:3) (1500 RPM - 28°)	Inlet	90	85	86	85	84	84	86	83	95
HC 90 T4/T8 (A6:3) (1500 RPM - 30°)	Inlet	91	87	87	87	85	85	87	83	96
HC 90 T4/T8 (A6:3) (1500 RPM - 32°)	Inlet	91	87	87	89	86	86	87	84	97
HC 90 T4/T8 (A6:3) (1500 RPM - 34°)	Inlet	92	88	88	90	87	87	88	84	97
HC 90 T4/T8 (A6:3) (1500 RPM - 36°)	Inlet	92	88	88	91	87	88	88	85	98
HC 90 T4/T8 (A6:3) (1500 RPM - 38°)	Inlet	92	89	89	92	89	89	89	86	99
HC 90 T4/T8 (A6:3) (1500 RPM - 40°)	Inlet	92	90	90	92	90	90	90	87	99
HC 90 T4/T8 (A6:3) (1500 RPM - 42°)	Inlet	93	91	91	93	91	91	91	87	101
HC 90 T4/T8 (A6:6) (750 RPM - 20°)	Inlet	75	75	74	76	76	73	74	71	84
HC 90 T4/T8 (A6:6) (750 RPM - 22°)	Inlet	76	75	74	76	76	74	74	72	84
HC 90 T4/T8 (A6:6) (750 RPM - 24°)	Inlet	77	76	75	77	76	74	75	72	85
HC 90 T4/T8 (A6:6) (750 RPM - 26°)	Inlet	78	77	76	77	76	75	76	73	85
HC 90 T4/T8 (A6:6) (750 RPM - 28°)	Inlet	78	77	76	77	76	75	76	73	86
HC 90 T4/T8 (A6:6) (750 RPM - 30°)	Inlet	79	78	76	78	76	75	76	74	86
HC 90 T4/T8 (A6:6) (750 RPM - 32°)	Inlet	78	77	75	76	74	74	75	72	85
HC 90 T4/T8 (A6:6) (750 RPM - 34°)	Inlet	76	75	73	74	72	72	74	70	83
HC 90 T4/T8 (A6:6) (750 RPM - 36°)	Inlet	76	75	73	73	72	72	73	70	82
HC 90 T4/T8 (A6:6) (750 RPM - 38°)	Inlet	77	76	74	74	72	72	74	70	83

Sound power Lw dB (A)										
Model		63 Hz	125 Hz	250 Hz	500 Hz	1000 Hz	2000 Hz	4000 Hz	8000 Hz	Total
HC 90 T4/T8 (A6:6) (750 RPM - 40°)	Inlet	78	76	74	75	73	73	74	70	84
HC 90 T4/T8 (A6:6) (750 RPM - 42°)	Inlet	78	77	75	75	73	73	75	71	85
HC 90 T4/T8 (A6:6) (1500 RPM - 20°)	Inlet	91	91	90	91	92	89	90	87	99
HC 90 T4/T8 (A6:6) (1500 RPM - 22°)	Inlet	92	91	90	92	92	90	90	88	100
HC 90 T4/T8 (A6:6) (1500 RPM - 24°)	Inlet	93	92	91	92	92	90	91	88	101
HC 90 T4/T8 (A6:6) (1500 RPM - 26°)	Inlet	93	93	91	93	92	90	91	89	101
HC 90 T4/T8 (A6:6) (1500 RPM - 28°)	Inlet	94	93	92	93	92	91	92	89	102
HC 90 T4/T8 (A6:6) (1500 RPM - 30°)	Inlet	95	94	92	93	92	91	92	90	102
HC 90 T4/T8 (A6:6) (1500 RPM - 32°)	Inlet	94	93	91	92	90	89	91	88	101
HC 90 T4/T8 (A6:6) (1500 RPM - 34°)	Inlet	92	91	89	90	88	88	90	86	99
HC 90 T4/T8 (A6:6) (1500 RPM - 36°)	Inlet	92	91	89	89	88	88	89	86	98
HC 90 T4/T8 (A6:6) (1500 RPM - 38°)	Inlet	93	92	90	90	88	88	90	86	99
HC 90 T4/T8 (A6:6) (1500 RPM - 40°)	Inlet	94	92	90	91	89	89	90	86	100
HC 90 T4/T8 (A6:6) (1500 RPM - 42°)	Inlet	94	93	91	91	89	89	90	86	101
HC 100 T4/T8 (A6:3) (750 RPM - 20°)	Inlet	74	71	69	68	71	71	75	69	81
HC 100 T4/T8 (A6:3) (750 RPM - 22°)	Inlet	75	72	70	70	71	72	75	70	82
HC 100 T4/T8 (A6:3) (750 RPM - 24°)	Inlet	76	72	71	70	71	72	75	70	82
HC 100 T4/T8 (A6:3) (750 RPM - 26°)	Inlet	76	72	71	70	71	71	74	69	81
HC 100 T4/T8 (A6:3) (750 RPM - 28°)	Inlet	76	72	71	71	71	71	73	69	81
HC 100 T4/T8 (A6:3) (750 RPM - 30°)	Inlet	76	72	71	71	70	70	72	68	81
HC 100 T4/T8 (A6:3) (750 RPM - 32°)	Inlet	78	73	73	73	72	72	73	69	82
HC 100 T4/T8 (A6:3) (750 RPM - 34°)	Inlet	79	75	74	74	73	73	73	70	84

Sound power Lw dB (A)										
Model		63 Hz	125 Hz	250 Hz	500 Hz	1000 Hz	2000 Hz	4000 Hz	8000 Hz	Total
HC 100 T4/T8 (A6:3) (750 RPM - 36°)	Inlet	80	75	75	75	74	73	74	71	85
HC 100 T4/T8 (A6:3) (750 RPM - 38°)	Inlet	79	76	75	76	74	74	74	72	85
HC 100 T4/T8 (A6:3) (750 RPM - 40°)	Inlet	79	77	75	77	75	75	75	72	85
HC 100 T4/T8 (A6:3) (750 RPM - 42°)	Inlet	79	77	76	77	76	76	76	73	86
HC 100 T4/T8 (A6:3) (1500 RPM - 20°)	Inlet	90	87	85	84	87	87	91	85	97
HC 100 T4/T8 (A6:3) (1500 RPM - 22°)	Inlet	91	88	86	86	87	88	91	86	97
HC 100 T4/T8 (A6:3) (1500 RPM - 24°)	Inlet	92	88	87	86	87	87	90	86	97
HC 100 T4/T8 (A6:3) (1500 RPM - 26°)	Inlet	92	88	87	86	87	87	90	85	97
HC 100 T4/T8 (A6:3) (1500 RPM - 28°)	Inlet	92	88	87	86	86	87	89	85	97
HC 100 T4/T8 (A6:3) (1500 RPM - 30°)	Inlet	92	88	87	87	86	86	88	84	97
HC 100 T4/T8 (A6:3) (1500 RPM - 32°)	Inlet	94	89	89	88	87	87	89	85	98
HC 100 T4/T8 (A6:3) (1500 RPM - 34°)	Inlet	95	91	90	90	89	89	89	86	100
HC 100 T4/T8 (A6:3) (1500 RPM - 36°)	Inlet	95	91	91	91	90	89	90	87	101
HC 100 T4/T8 (A6:3) (1500 RPM - 38°)	Inlet	95	92	91	92	90	90	90	87	101
HC 100 T4/T8 (A6:3) (1500 RPM - 40°)	Inlet	95	93	91	93	91	91	91	88	101
HC 100 T4/T8 (A6:3) (1500 RPM - 42°)	Inlet	95	93	92	93	92	92	92	89	102
HC 100 T4/T8 (A6:6) (750 RPM - 20°)	Inlet	79	80	78	82	80	78	78	76	89
HC 100 T4/T8 (A6:6) (750 RPM - 22°)	Inlet	79	80	78	82	79	78	78	76	89
HC 100 T4/T8 (A6:6) (750 RPM - 24°)	Inlet	80	80	78	81	79	78	78	76	88
HC 100 T4/T8 (A6:6) (750 RPM - 26°)	Inlet	81	81	79	82	79	78	79	76	89
HC 100 T4/T8 (A6:6) (750 RPM - 28°)	Inlet	83	81	80	82	79	79	80	77	90
HC 100 T4/T8 (A6:6) (750 RPM - 30°)	Inlet	83	81	81	81	79	78	80	77	90

Sound power Lw dB (A)										
Model		63 Hz	125 Hz	250 Hz	500 Hz	1000 Hz	2000 Hz	4000 Hz	8000 Hz	Total
HC 100 T4/T8 (A6:6) (750 RPM - 32°)	Inlet	83	81	80	79	78	77	78	75	89
HC 100 T4/T8 (A6:6) (750 RPM - 34°)	Inlet	82	80	79	77	76	76	77	74	88
HC 100 T4/T8 (A6:6) (750 RPM - 36°)	Inlet	81	79	78	76	76	75	77	73	87
HC 100 T4/T8 (A6:6) (750 RPM - 38°)	Inlet	82	80	79	77	77	76	77	74	88
HC 100 T4/T8 (A6:6) (750 RPM - 40°)	Inlet	83	81	79	78	77	77	78	74	89
HC 100 T4/T8 (A6:6) (750 RPM - 42°)	Inlet	83	81	79	78	77	77	78	74	88
HC 100 T4/T8 (A6:6) (1500 RPM - 20°)	Inlet	95	96	94	98	96	94	94	92	105
HC 100 T4/T8 (A6:6) (1500 RPM - 22°)	Inlet	95	96	94	98	95	94	94	92	105
HC 100 T4/T8 (A6:6) (1500 RPM - 24°)	Inlet	96	96	94	97	95	94	94	92	104
HC 100 T4/T8 (A6:6) (1500 RPM - 26°)	Inlet	97	97	95	97	95	94	95	92	105
HC 100 T4/T8 (A6:6) (1500 RPM - 28°)	Inlet	99	97	96	98	95	94	95	93	106
HC 100 T4/T8 (A6:6) (1500 RPM - 30°)	Inlet	99	97	96	97	95	94	96	93	106
HC 100 T4/T8 (A6:6) (1500 RPM - 32°)	Inlet	98	97	95	95	94	93	94	91	105
HC 100 T4/T8 (A6:6) (1500 RPM - 34°)	Inlet	98	96	95	93	92	92	93	90	104
HC 100 T4/T8 (A6:6) (1500 RPM - 36°)	Inlet	97	95	94	92	92	91	93	89	103
HC 100 T4/T8 (A6:6) (1500 RPM - 38°)	Inlet	98	96	95	93	92	92	93	90	104
HC 100 T4/T8 (A6:6) (1500 RPM - 40°)	Inlet	99	97	95	94	93	93	94	90	105
HC 100 T4/T8 (A6:6) (1500 RPM - 42°)	Inlet	98	96	95	94	93	93	94	90	104
HC 112 T4/T8 (A6:3) (750 RPM - 20°)	Inlet	78	75	73	74	75	75	78	74	85
HC 112 T4/T8 (A6:3) (750 RPM - 22°)	Inlet	79	76	74	75	76	76	78	75	86
HC 112 T4/T8 (A6:3) (750 RPM - 24°)	Inlet	80	77	75	75	76	76	79	75	86
HC 112 T4/T8 (A6:3) (750 RPM - 26°)	Inlet	81	77	76	76	76	76	79	76	87

Sound power Lw dB (A)										
Model		63 Hz	125 Hz	250 Hz	500 Hz	1000 Hz	2000 Hz	4000 Hz	8000 Hz	Total
HC 112 T4/T8 (A6:3) (750 RPM - 28°)	Inlet	81	77	76	76	76	76	78	75	87
HC 112 T4/T8 (A6:3) (750 RPM - 30°)	Inlet	81	77	76	76	76	75	78	75	87
HC 112 T4/T8 (A6:3) (750 RPM - 32°)	Inlet	82	77	77	77	76	75	78	75	87
HC 112 T4/T8 (A6:3) (750 RPM - 34°)	Inlet	83	77	78	77	76	75	77	75	87
HC 112 T4/T8 (A6:3) (750 RPM - 36°)	Inlet	83	78	78	77	76	76	77	75	88
HC 112 T4/T8 (A6:3) (750 RPM - 38°)	Inlet	83	79	78	78	77	77	77	75	88
HC 112 T4/T8 (A6:3) (750 RPM - 40°)	Inlet	83	79	78	78	77	77	77	75	88
HC 112 T4/T8 (A6:3) (750 RPM - 42°)	Inlet	83	80	78	79	78	78	78	75	88
HC 112 T4/T8 (A6:3) (1500 RPM - 20°)	Inlet	93	90	88	89	91	91	93	90	101
HC 112 T4/T8 (A6:3) (1500 RPM - 22°)	Inlet	95	92	90	90	92	92	94	91	102
HC 112 T4/T8 (A6:3) (1500 RPM - 24°)	Inlet	96	93	91	91	92	92	94	91	102
HC 112 T4/T8 (A6:3) (1500 RPM - 26°)	Inlet	97	93	92	92	92	92	95	91	103
HC 112 T4/T8 (A6:3) (1500 RPM - 28°)	Inlet	97	93	92	92	92	92	94	91	103
HC 112 T4/T8 (A6:3) (1500 RPM - 30°)	Inlet	97	93	92	92	92	91	94	91	103
HC 112 T4/T8 (A6:3) (1500 RPM - 32°)	Inlet	98	93	93	92	92	91	93	91	103
HC 112 T4/T8 (A6:3) (1500 RPM - 34°)	Inlet	99	93	94	93	92	91	93	91	103
HC 112 T4/T8 (A6:3) (1500 RPM - 36°)	Inlet	99	94	94	93	92	92	93	91	104
HC 112 T4/T8 (A6:3) (1500 RPM - 38°)	Inlet	99	95	94	94	93	92	93	91	104
HC 112 T4/T8 (A6:3) (1500 RPM - 40°)	Inlet	99	95	94	94	93	93	93	91	104
HC 112 T4/T8 (A6:3) (1500 RPM - 42°)	Inlet	99	96	94	95	94	94	94	91	104
HC 112 T4/T8 (A6:6) (750 RPM - 20°)	Inlet	79	80	79	85	82	80	81	78	90
HC 112 T4/T8 (A6:6) (750 RPM - 22°)	Inlet	80	81	79	84	82	80	81	78	90

Sound power Lw dB (A)										
Model		63 Hz	125 Hz	250 Hz	500 Hz	1000 Hz	2000 Hz	4000 Hz	8000 Hz	Total
HC 112 T4/T8 (A6:6) (750 RPM - 24°)	Inlet	81	80	79	83	81	79	80	77	90
HC 112 T4/T8 (A6:6) (750 RPM - 26°)	Inlet	83	81	79	82	81	80	81	77	90
HC 112 T4/T8 (A6:6) (750 RPM - 28°)	Inlet	84	82	80	82	81	80	81	77	91
HC 112 T4/T8 (A6:6) (750 RPM - 30°)	Inlet	85	82	80	81	80	80	81	76	91
HC 112 T4/T8 (A6:6) (750 RPM - 32°)	Inlet	85	82	80	80	79	79	80	75	90
HC 112 T4/T8 (A6:6) (750 RPM - 34°)	Inlet	84	81	79	78	78	78	79	74	89
HC 112 T4/T8 (A6:6) (750 RPM - 36°)	Inlet	85	82	80	78	78	79	79	74	90
HC 112 T4/T8 (A6:6) (750 RPM - 38°)	Inlet	87	83	82	80	80	80	81	76	91
HC 112 T4/T8 (A6:6) (750 RPM - 40°)	Inlet	89	85	83	81	81	81	82	77	93
HC 112 T4/T8 (A6:6) (750 RPM - 42°)	Inlet	89	84	83	81	81	81	81	77	93
HC 112 T4/T8 (A6:6) (1500 RPM - 20°)	Inlet	95	96	95	101	98	96	97	94	106
HC 112 T4/T8 (A6:6) (1500 RPM - 22°)	Inlet	96	96	95	99	98	96	97	94	106
HC 112 T4/T8 (A6:6) (1500 RPM - 24°)	Inlet	97	96	95	98	97	95	96	93	106
HC 112 T4/T8 (A6:6) (1500 RPM - 26°)	Inlet	98	97	95	98	97	96	97	93	106
HC 112 T4/T8 (A6:6) (1500 RPM - 28°)	Inlet	100	98	96	98	97	96	97	93	107
HC 112 T4/T8 (A6:6) (1500 RPM - 30°)	Inlet	101	98	96	97	96	96	97	92	107
HC 112 T4/T8 (A6:6) (1500 RPM - 32°)	Inlet	101	97	95	95	95	95	96	91	106
HC 112 T4/T8 (A6:6) (1500 RPM - 34°)	Inlet	100	97	95	94	94	94	95	90	105
HC 112 T4/T8 (A6:6) (1500 RPM - 36°)	Inlet	101	98	96	94	94	94	95	90	106
HC 112 T4/T8 (A6:6) (1500 RPM - 38°)	Inlet	103	99	98	95	96	96	97	92	107
HC 112 T4/T8 (A6:6) (1500 RPM - 40°)	Inlet	105	101	99	97	97	97	98	93	109
HC 112 T4/T8 (A6:6) (1500 RPM - 42°)	Inlet	105	100	99	97	97	97	97	93	109

Sound power Lw dB (A)										
Model		63 Hz	125 Hz	250 Hz	500 Hz	1000 Hz	2000 Hz	4000 Hz	8000 Hz	Total
HC 125 T4/T8 (A7:4) (750 RPM - 20°)	Inlet	82	86	83	85	86	85	87	86	94
HC 125 T4/T8 (A7:4) (750 RPM - 22°)	Inlet	85	87	85	86	86	86	88	86	95
HC 125 T4/T8 (A7:4) (750 RPM - 24°)	Inlet	86	85	83	83	84	84	86	83	93
HC 125 T4/T8 (A7:4) (750 RPM - 26°)	Inlet	86	84	82	81	82	82	83	81	92
HC 125 T4/T8 (A7:4) (750 RPM - 28°)	Inlet	86	82	80	80	80	81	82	78	91
HC 125 T4/T8 (A7:4) (750 RPM - 30°)	Inlet	84	81	79	77	78	79	80	75	89
HC 125 T4/T8 (A7:4) (750 RPM - 32°)	Inlet	84	81	79	77	78	78	79	74	89
HC 125 T4/T8 (A7:4) (750 RPM - 34°)	Inlet	83	80	78	77	77	78	79	73	89
HC 125 T4/T8 (A7:4) (750 RPM - 36°)	Inlet	84	81	79	78	77	78	79	73	89
HC 125 T4/T8 (A7:4) (750 RPM - 38°)	Inlet	85	82	80	79	78	79	80	74	90
HC 125 T4/T8 (A7:4) (750 RPM - 40°)	Inlet	86	82	80	79	78	79	80	75	90
HC 125 T4/T8 (A7:4) (750 RPM - 42°)	Inlet	86	83	81	80	79	80	80	76	91
HC 125 T4/T8 (A7:4) (1500 RPM - 20°)	Inlet	98	102	99	101	102	101	103	102	110
HC 125 T4/T8 (A7:4) (1500 RPM - 22°)	Inlet	101	103	101	102	102	102	104	102	111
HC 125 T4/T8 (A7:4) (1500 RPM - 24°)	Inlet	102	101	99	99	100	100	102	99	109
HC 125 T4/T8 (A7:4) (1500 RPM - 26°)	Inlet	102	100	98	97	98	98	99	96	108
HC 125 T4/T8 (A7:4) (1500 RPM - 28°)	Inlet	102	98	96	95	96	97	98	94	107
HC 125 T4/T8 (A7:4) (1500 RPM - 30°)	Inlet	100	97	95	93	94	95	96	91	105
HC 125 T4/T8 (A7:4) (1500 RPM - 32°)	Inlet	100	97	95	93	93	94	95	90	105
HC 125 T4/T8 (A7:4) (1500 RPM - 34°)	Inlet	99	96	94	93	93	94	95	89	105
HC 125 T4/T8 (A7:4) (1500 RPM - 36°)	Inlet	100	97	95	93	93	94	95	89	105
HC 125 T4/T8 (A7:4) (1500 RPM - 38°)	Inlet	101	98	96	94	94	95	95	90	106

Sound power Lw dB (A)										
Model		63 Hz	125 Hz	250 Hz	500 Hz	1000 Hz	2000 Hz	4000 Hz	8000 Hz	Total
HC 125 T4/T8 (A7:4) (1500 RPM - 40°)	Inlet	102	98	96	95	94	95	95	91	106
HC 125 T4/T8 (A7:4) (1500 RPM - 42°)	Inlet	102	99	97	95	95	96	96	91	107
HC 125 T4/T8 (A7:8) (750 RPM - 20°)	Inlet	88	86	85	88	91	93	92	89	99
HC 125 T4/T8 (A7:8) (750 RPM - 22°)	Inlet	88	85	85	87	90	92	91	88	98
HC 125 T4/T8 (A7:8) (750 RPM - 24°)	Inlet	88	85	84	86	89	90	90	86	97
HC 125 T4/T8 (A7:8) (750 RPM - 26°)	Inlet	88	84	83	85	87	89	89	85	96
HC 125 T4/T8 (A7:8) (750 RPM - 28°)	Inlet	88	84	83	83	86	88	88	83	95
HC 125 T4/T8 (A7:8) (750 RPM - 30°)	Inlet	87	83	82	82	84	86	86	81	94
HC 125 T4/T8 (A7:8) (750 RPM - 32°)	Inlet	87	83	82	82	83	84	85	79	93
HC 125 T4/T8 (A7:8) (750 RPM - 34°)	Inlet	88	84	82	81	82	83	83	77	93
HC 125 T4/T8 (A7:8) (750 RPM - 36°)	Inlet	88	84	83	81	81	82	82	77	92
HC 125 T4/T8 (A7:8) (750 RPM - 38°)	Inlet	88	85	83	81	81	82	81	76	92
HC 125 T4/T8 (A7:8) (750 RPM - 40°)	Inlet	87	84	82	81	81	82	80	76	92
HC 125 T4/T8 (A7:8) (750 RPM - 42°)	Inlet	87	84	82	81	81	81	80	76	92
HC 125 T4/T8 (A7:8) (1500 RPM - 20°)	Inlet	104	102	101	104	107	109	108	105	115
HC 125 T4/T8 (A7:8) (1500 RPM - 22°)	Inlet	104	101	101	103	106	108	107	104	114
HC 125 T4/T8 (A7:8) (1500 RPM - 24°)	Inlet	104	101	100	102	105	106	106	102	113
HC 125 T4/T8 (A7:8) (1500 RPM - 26°)	Inlet	104	100	99	101	103	105	105	101	112
HC 125 T4/T8 (A7:8) (1500 RPM - 28°)	Inlet	104	99	99	99	102	104	104	99	111
HC 125 T4/T8 (A7:8) (1500 RPM - 30°)	Inlet	103	99	98	98	100	102	102	97	110
HC 125 T4/T8 (A7:8) (1500 RPM - 32°)	Inlet	103	99	98	97	99	100	101	95	109
HC 125 T4/T8 (A7:8) (1500 RPM - 34°)	Inlet	104	99	98	97	98	99	99	93	109

Sound power Lw dB (A)										
Model		63 Hz	125 Hz	250 Hz	500 Hz	1000 Hz	2000 Hz	4000 Hz	8000 Hz	Total
HC 125 T4/T8 (A7:8) (1500 RPM - 36°)	Inlet	104	100	98	97	97	98	98	92	108
HC 125 T4/T8 (A7:8) (1500 RPM - 38°)	Inlet	104	101	98	97	97	98	97	92	108
HC 125 T4/T8 (A7:8) (1500 RPM - 40°)	Inlet	103	100	98	97	97	98	96	92	108
HC 125 T4/T8 (A7:8) (1500 RPM - 42°)	Inlet	103	100	98	97	97	97	96	92	108

erp data

ERP	
Fan type	Axial fan
Installation category	A
Efficiency category	Static
The fan has to be installed with FSC	No

ERP / 4 poles

Model	Motor power (kW)	Maximum efficiency point data						
		Max. efficiency (%)	Efficiency grade (N) (N)	Air Flow (m ³ /h)	Ps (Pa)	Pabs (kW)	speed (rpm)	Specific ratio
HC 35 M4 (A0:6) (35°)	0,12	27,54	38,54	1.997,21	90,99	0,18	-	1,00
HC 35 M4 (A0:6) (40°)	0,12	26,76	37,45	2.141,46	92,67	0,20	-	1,00
HC 35 T4 (A0:6) (35°)	0,12	32,95	44,44	1.997,21	90,99	0,15	-	1,00
HC 35 T4 (A0:6) (40°)	0,12	31,26	42,37	2.141,46	92,67	0,18	-	1,00
HC 40 M4 (A0:6) (35°)	0,18	29,85	39,92	2.668,81	102,89	0,26	-	1,00
HC 40 M4 (A0:6) (40°)	0,18	29,48	39,18	2.878,36	107,65	0,29	-	1,00
HC 40 T4 (A0:6) (35°)	0,18	37,99	48,72	2.668,81	102,89	0,20	-	1,00
HC 40 T4 (A0:6) (40°)	0,18	36,08	46,34	2.878,36	107,65	0,24	-	1,00
HC 45 M4 (A0:6) (35°)	0,25	30,99	40,16	3.702,84	106,29	0,36	-	1,00
HC 45 M4 (A0:6) (40°)	0,25	31,57	40,33	4.049,07	115,97	0,41	-	1,00
HC 45 M4 (A5:6) (25°)	0,25	25,20	34,85	2.807,25	95,89	0,30	-	1,00
HC 45 M4 (A5:6) (30°)	0,25	26,02	35,21	3.214,30	102,62	0,35	-	1,00
HC 45 M4 (A5:6) (35°)	0,37	24,66	33,29	3.695,82	104,82	0,43	-	1,00
HC 45 T4 (A0:6) (35°)	0,25	39,37	49,19	3.702,84	106,29	0,28	-	1,00
HC 45 T4 (A0:6) (40°)	0,25	38,70	48,01	4.049,07	115,97	0,34	-	1,00
HC 45 T4 (A5:6) (25°)	0,25	33,59	44,03	2.807,25	95,89	0,22	-	1,00
HC 45 T4 (A5:6) (30°)	0,25	33,08	42,93	3.214,30	102,62	0,28	-	1,00
HC 45 T4 (A5:6) (35°)	0,37	31,47	40,77	3.695,82	104,82	0,34	-	1,00
HC 45 T4 (A5:6) (40°)	0,37	28,36	37,13	4.124,29	102,56	0,41	-	1,00
HC 50 M4 (A0:6) (35°)	0,37	33,57	42,06	4.442,56	123,26	0,45	-	1,00
HC 50 M4 (A0:6) (40°)	0,37	33,54	41,56	5.154,60	125,37	0,54	-	1,00
HC 50 M4 (A5:6) (25°)	0,25	30,21	39,16	3.820,69	109,57	0,39	-	1,00
HC 50 M4 (A5:6) (30°)	0,37	29,53	37,84	4.377,18	118,42	0,49	-	1,00
HC 50 T4 (A0:6) (35°)	0,37	42,23	51,35	4.442,56	123,26	0,36	-	1,00
HC 50 T4 (A0:6) (40°)	0,37	41,53	50,14	5.154,60	125,37	0,44	-	1,00
HC 50 T4 (A5:6) (25°)	0,25	37,58	47,13	3.820,69	109,57	0,31	-	1,00
HC 50 T4 (A5:6) (30°)	0,37	36,68	45,59	4.377,18	118,42	0,39	-	1,00
HC 50 T4 (A5:6) (35°)	0,55	34,41	42,75	4.997,36	120,39	0,48	-	1,00

Model	Motor power (kW)	Maximum efficiency point data						
		Max. efficiency (%)	Efficiency grade (N) (N)	Air Flow (m ³ /h)	Ps (Pa)	Pabs (kW)	speed (rpm)	Specific ratio
HC 50 T4 (A5:6) (40º)	0,55	30,35	38,15	5.685,65	115,53	0,59	-	1,00
HC 56 M4 (A2:6) (20º)	0,37	34,46	42,57	4.266,24	151,17	0,52	-	1,00
HC 56 M4 (A5:6) (20º)	0,37	36,49	44,51	4.495,62	156,81	0,54	-	1,00
HC 56 T4 (A2:6) (20º)	0,37	42,66	51,36	4.266,24	151,17	0,42	-	1,00
HC 56 T4 (A2:6) (25º)	0,55	44,74	52,63	5.406,36	167,16	0,57	-	1,00
HC 56 T4 (A2:6) (27,5º)	0,55	44,13	51,78	5.683,27	171,50	0,62	-	1,00
HC 56 T4 (A2:6) (30º)	0,75	43,31	50,46	6.312,70	182,48	0,74	-	1,00
HC 56 T4 (A2:6) (32,5º)	0,75	41,54	48,32	6.816,48	186,16	0,85	-	1,00
HC 56 T4 (A2:6) (35º)	1,10	40,81	47,28	7.342,60	190,02	0,95	-	1,00
HC 56 T4 (A2:6) (37,5º)	1,10	40,23	46,45	7.862,73	190,73	1,04	-	1,00
HC 56 T4 (A2:6) (40º)	1,10	39,29	45,24	8.480,79	189,26	1,15	-	1,00
HC 56 T4 (A2:6) (42,5º)	1,50	35,79	41,42	9.378,45	175,73	1,29	-	1,00
HC 56 T4 (A2:6) (45º)	1,50	33,90	39,39	9.821,66	168,93	1,36	-	1,00
HC 56 T4 (A2:9) (20º)	0,55	43,18	51,09	4.510,05	188,20	0,56	-	1,00
HC 56 T4 (A2:9) (25º)	0,75	44,95	52,07	5.727,70	206,64	0,75	-	1,00
HC 56 T4 (A2:9) (27,5º)	0,75	44,41	51,28	6.096,34	211,34	0,82	-	1,00
HC 56 T4 (A2:9) (30º)	1,10	44,08	50,45	6.957,51	222,61	0,99	-	1,00
HC 56 T4 (A2:9) (32,5º)	1,10	42,64	48,70	7.427,79	228,49	1,11	-	1,00
HC 56 T4 (A2:9) (35º)	1,10	41,32	47,08	7.870,82	234,75	1,23	-	1,00
HC 56 T4 (A2:9) (37,5º)	1,50	41,13	46,64	8.527,29	232,60	1,35	-	1,00
HC 56 T4 (A2:9) (40º)	1,50	39,82	45,06	9.032,45	234,01	1,49	-	1,00
HC 56 T4 (A2:9) (42,5º)	1,50	38,18	43,05	9.753,80	237,69	1,71	-	1,00
HC 56 T4 (A2:9) (45º)	2,20	39,10	43,90	10.151,47	238,50	1,75	-	1,00
HC 56 T4 (A5:6) (20º)	0,37	45,22	53,82	4.495,62	156,81	0,44	-	1,00
HC 56 T4 (A5:6) (25º)	0,55	49,01	57,11	5.837,90	157,13	0,52	-	1,00
HC 56 T4 (A5:6) (30º)	0,55	49,99	57,60	6.824,50	161,71	0,63	-	1,00
HC 56 T4 (A5:6) (35º)	0,75	47,66	54,67	7.938,85	170,02	0,78	-	1,00
HC 56 T4 (A5:6) (40º)	1,10	39,26	45,21	9.132,29	181,13	1,15	-	1,00
HC 56 T4 (A5:6) (45º)	1,50	35,23	40,59	9.839,96	185,64	1,43	-	1,00
HC 63 T4 (A2:6) (20º)	0,55	46,54	54,64	5.597,59	156,21	0,53	-	1,00
HC 63 T4 (A2:6) (25º)	0,75	47,61	54,69	7.295,27	176,58	0,76	-	1,00
HC 63 T4 (A2:6) (27,5º)	0,75	47,56	54,37	7.744,65	183,98	0,84	-	1,00
HC 63 T4 (A2:6) (30º)	1,10	47,75	54,02	8.772,94	199,68	1,02	-	1,00
HC 63 T4 (A2:6) (32,5º)	1,10	46	51,86	9.516,33	206,89	1,19	-	1,00
HC 63 T4 (A2:6) (35º)	1,50	44,72	50,21	10.251,35	213,86	1,36	-	1,00
HC 63 T4 (A2:6) (37,5º)	1,50	42,98	48,16	10.889,88	217,69	1,52	-	1,00
HC 63 T4 (A2:6) (40º)	1,50	40,99	45,84	11.637,19	219,76	1,72	-	1,00
HC 63 T4 (A2:6) (42,5º)	2,20	42,28	47,02	13.042,69	205,81	1,78	-	1,00

Model	Motor power (kW)	Maximum efficiency point data						
		Max. efficiency (%)	Efficiency grade (N) (N)	Air Flow (m3/h)	Ps (Pa)	Pabs (kW)	speed (rpm)	Specific ratio
HC 63 T4 (A2:6) (45º)	2,20	41,53	46,18	13.663,22	200,21	1,85	-	1,00
HC 63 T4 (A2:9) (20º)	0,75	47,17	54,13	6.148,87	213,88	0,79	-	1,00
HC 63 T4 (A2:9) (25º)	1,10	48,94	55,07	7.962,04	233,30	1,07	-	1,00
HC 63 T4 (A2:9) (27,5º)	1,10	48,40	54,24	8.505,02	241,06	1,20	-	1,00
HC 63 T4 (A2:9) (30º)	1,50	47,84	53,07	9.754,93	258,40	1,49	-	1,00
HC 63 T4 (A2:9) (32,5º)	2,20	47,54	52,45	10.591,50	268,69	1,68	-	1,00
HC 63 T4 (A2:9) (35º)	2,20	45,49	50,02	11.259,62	280,23	1,93	-	1,00
HC 63 T4 (A2:9) (37,5º)	2,20	44,35	48,60	12.083,39	281,74	2,14	-	1,00
HC 63 T4 (A2:9) (40º)	2,20	43,30	47,27	12.859,31	284,14	2,36	-	1,00
HC 63 T4 (A2:9) (42,5º)	3	42,13	45,84	14.284,18	273,90	2,61	-	1,00
HC 63 T4 (A2:9) (45º)	3	41,37	44,93	14.927,31	270,56	2,74	-	1,00
HC 63 T4 (A5:6) (20º)	0,55	58,44	66,30	6.389,10	183,64	0,57	-	1,00
HC 63 T4 (A5:6) (25º)	0,75	57	64,09	7.776,55	192,57	0,76	-	1,00
HC 63 T4 (A5:6) (30º)	1,10	50,05	55,85	9.522,02	226,10	1,22	-	1,00
HC 63 T4 (A5:6) (35º)	1,50	46,36	51,58	10.712,41	232,53	1,50	-	1,00
HC 63 T4 (A5:6) (40º)	2,20	43,08	47,68	12.458,07	235,51	1,88	-	1,00
HC 63 T4 (A5:6) (45º)	2,20	38,10	42,19	13.997,47	219,16	2,26	-	1,00
HC 71 T4 (A2:6) (20º)	0,75	50,01	57,20	7.232,09	180,97	0,73	-	1,00
HC 71 T4 (A2:6) (25º)	1,10	51,02	57,10	9.713,86	205,13	1,09	-	1,00
HC 71 T4 (A2:6) (27,5º)	1,10	50,62	56,39	10.445,36	212,23	1,23	-	1,00
HC 71 T4 (A2:6) (30º)	1,50	49,55	54,68	12.220,43	224,43	1,55	-	1,00
HC 71 T4 (A2:6) (32,5º)	2,20	49,93	54,74	13.295,01	234,64	1,74	-	1,00
HC 71 T4 (A2:6) (35º)	2,20	48,30	52,71	14.300,74	245,13	2,01	-	1,00
HC 71 T4 (A2:6) (37,5º)	2,20	46,71	50,85	15.321,60	243,73	2,22	-	1,00
HC 71 T4 (A2:6) (40º)	2,20	44,72	48,55	16.418,70	242,62	2,49	-	1,00
HC 71 T4 (A2:6) (42,5º)	3	42,46	45,98	18.344,18	230,23	2,79	-	1,00
HC 71 T4 (A2:6) (45º)	3	41,05	44,42	19.243,09	224,55	2,95	-	1,00
HC 71 T4 (A2:9) (20º)	1,10	50,72	56,91	7.655,80	248,42	1,05	-	1,00
HC 71 T4 (A2:9) (25º)	1,50	52,10	57,31	10.640,51	257,93	1,51	-	1,00
HC 71 T4 (A2:9) (27,5º)	1,50	51,40	56,31	11.378,55	267,44	1,68	-	1,00
HC 71 T4 (A2:9) (30º)	2,20	51,57	55,93	13.009,18	289,31	2,05	-	1,00
HC 71 T4 (A2:9) (32,5º)	2,20	49,79	53,74	14.180,50	297,36	2,38	-	1,00
HC 71 T4 (A2:9) (35º)	3	48,37	51,95	15.396,63	304,31	2,73	-	1,00
HC 71 T4 (A2:9) (37,5º)	3	46,73	49,99	16.573,97	309,50	3,07	-	1,00
HC 71 T4 (A2:9) (40º)	4	45,40	48,37	17.946,26	309,93	3,41	-	1,00
HC 71 T4 (A2:9) (42,5º)	4	43,23	45,91	18.398,10	316,72	3,78	-	1,00
HC 71 T4 (A2:9) (45º)	4	42,42	44,94	20.056,09	303,54	4,02	-	1,00
HC 71 T4 (A5:6) (20º)	0,75	57,58	64,41	8.372,56	199,99	0,83	-	1,00

Model	Motor power (kW)	Maximum efficiency point data						
		Max. efficiency (%)	Efficiency grade (N) (N)	Air Flow (m3/h)	Ps (Pa)	Pabs (kW)	speed (rpm)	Specific ratio
HC 71 T4 (A5:6) (25º)	1,10	51,46	57,12	10.421,74	221,18	1,28	-	1,00
HC 71 T4 (A5:6) (30º)	1,50	50,13	54,98	12.513,58	242,11	1,72	-	1,00
HC 71 T4 (A5:6) (35º)	2,20	46,20	50,22	14.810,97	258,66	2,33	-	1,00
HC 71 T4 (A5:6) (40º)	3	42,78	46,35	16.494,79	256,36	2,74	-	1,00
HC 71 T4 (A5:6) (45º)	3	37,02	40,02	18.533,17	241,52	3,37	-	1,00
HC 80 T4 (A2:6) (20º)	1,10	53,21	59,63	9.017,50	205,42	0,97	-	1,00
HC 80 T4 (A2:6) (25º)	1,50	53,14	58,35	12.875,65	221,82	1,50	-	1,00
HC 80 T4 (A2:6) (27,5º)	1,50	52,90	57,79	13.912,06	229,68	1,69	-	1,00
HC 80 T4 (A2:6) (30º)	2,20	53,35	57,60	16.277,48	250,03	2,14	-	1,00
HC 80 T4 (A2:6) (32,5º)	3	52,01	55,85	17.909,79	258,43	2,49	-	1,00
HC 80 T4 (A2:6) (35º)	3	50,95	54,40	19.545,96	267,44	2,86	-	1,00
HC 80 T4 (A2:6) (37,5º)	3	48,19	51,27	20.944,62	272,86	3,29	-	1,00
HC 80 T4 (A2:6) (40º)	4	45,96	48,69	22.257,02	278,20	3,71	-	1,00
HC 80 T4 (A2:6) (42,5º)	4	42,32	44,58	24.366,89	272,71	4,42	-	1,00
HC 80 T4 (A2:6) (45º)	5,50	40,94	43,02	25.624,11	267,80	4,72	-	1,00
HC 80 T4 (A2:9) (20º)	1,50	52,55	57,83	9.930,44	277,46	1,47	-	1,00
HC 80 T4 (A2:9) (25º)	2,20	53,91	58,11	14.232,06	288,73	2,17	-	1,00
HC 80 T4 (A2:9) (27,5º)	2,20	53,20	57,10	15.356,78	294,47	2,42	-	1,00
HC 80 T4 (A2:9) (30º)	3	52,58	55,90	17.836,16	312,15	3	-	1,00
HC 80 T4 (A2:9) (32,5º)	4	50,15	52,98	19.620,62	325,17	3,59	-	1,00
HC 80 T4 (A2:9) (35º)	4	46,84	49,15	21.510,72	335,77	4,34	-	1,00
HC 80 T4 (A2:9) (37,5º)	5,50	46,12	48,16	22.829,66	347,67	4,79	-	1,00
HC 80 T4 (A2:9) (40º)	5,50	45,16	46,91	24.231,93	358,68	5,33	-	1,00
HC 80 T4 (A2:9) (42,5º)	7,50	43,97	45,39	26.699,82	351,80	6	-	1,00
HC 80 T4 (A2:9) (45º)	7,50	42,84	44,10	27.950,61	347,62	6,38	-	1,00
HC 80 T4 (A5:6) (20º)	1,50	50,60	56,25	9.718,37	239,52	1,28	-	1,00
HC 80 T4 (A5:6) (25º)	1,50	51,79	56,64	12.356,85	255,99	1,72	-	1,00
HC 80 T4 (A5:6) (30º)	3	57,60	61,42	17.261,55	298,01	2,50	-	1,00
HC 80 T4 (A5:6) (35º)	3	50,98	54,06	19.869,77	303,75	3,28	-	1,00
HC 80 T4 (A5:6) (40º)	4	48,60	51,08	22.484,61	317,95	4,08	-	1,00
HC 90 T4 (A6:3) (20º)	3	47,86	51,68	17.863,23	241,50	2,50	-	1,00
HC 90 T4 (A6:3) (22º)	3	47,91	51,28	19.477,11	260,37	2,94	-	1,00
HC 90 T4 (A6:3) (24º)	4	47,93	50,91	21.003,49	279,10	3,39	-	1,00
HC 90 T4 (A6:3) (26º)	4	46,77	49,36	22.226,07	297,64	3,92	-	1,00
HC 90 T4 (A6:3) (28º)	5,50	46,03	48,27	23.503,70	315,93	4,45	-	1,00
HC 90 T4 (A6:3) (30º)	5,50	43,90	45,82	25.124,90	318	5,01	-	1,00
HC 90 T4 (A6:3) (32º)	5,50	41,52	43,12	27.168,60	312,11	5,62	-	1,00
HC 90 T4 (A6:3) (34º)	7,50	39,63	40,95	28.904,06	310,41	6,23	-	1,00

Model	Maximum efficiency point data							
	Motor power (kW)	Max. efficiency (%)	Efficiency grade (N) (N)	Air Flow (m3/h)	Ps (Pa)	Pabs (kW)	speed (rpm)	Specific ratio
HC 90 T4 (A6:6) (20º)	4	50,24	52,64	20.935,53	357,55	4,21	-	1,00
HC 90 T4 (A6:6) (22º)	5,50	50,37	52,34	22.948,84	382,82	4,91	-	1,00
HC 90 T4 (A6:6) (24º)	5,50	49,83	51,39	24.822,91	408,33	5,72	-	1,00
HC 90 T4 (A6:6) (26º)	7,50	49,09	50,27	26.295,39	434,32	6,54	-	1,00
HC 90 T4 (A6:6) (28º)	7,50	47,70	48,49	27.997,79	455,42	7,55	-	1,00
HC 90 T4 (A6:6) (30º)	9,20	46,12	46,58	29.455,68	475,22	8,51	-	1,00
HC 90 T4 (A6:6) (32º)	9,20	44,24	44,39	31.020,14	487,87	9,56	-	1,00
HC 90 T4 (A6:6) (34º)	11	42,88	42,92	32.656,98	500,10	10,55	-	1,00
HC 90 T4 (A6:6) (36º)	11	41,66	41,63	34.544,58	503,44	11,60	-	1,00
HC 90 T4 (A6:6) (38º)	15	41,54	41,45	36.648,69	506,77	12,54	-	1,00
HC 100 T4 (A6:3) (20º)	5,50	52,97	55,80	23.588,59	289,56	3,60	-	1,00
HC 100 T4 (A6:3) (22º)	5,50	53,22	55,59	25.751,94	315,11	4,25	-	1,00
HC 100 T4 (A6:3) (24º)	5,50	52,70	54,63	27.799,11	338,97	4,98	-	1,00
HC 100 T4 (A6:3) (26º)	5,50	51,15	52,68	29.438,30	361,04	5,77	-	1,00
HC 100 T4 (A6:3) (28º)	7,50	50,33	51,51	31.256,32	380,11	6,55	-	1,00
HC 100 T4 (A6:3) (30º)	7,50	47,69	48,53	33.567,09	379,57	7,41	-	1,00
HC 100 T4 (A6:3) (32º)	9,20	45,02	45,55	36.499,40	370,95	8,30	-	1,00
HC 100 T4 (A6:3) (34º)	9,20	41,85	42,05	39.149,37	364,08	9,37	-	1,00
HC 100 T4 (A6:6) (20º)	7,50	53,61	55	27.055,23	423,93	6,07	-	1,00
HC 100 T4 (A6:6) (22º)	7,50	53,69	54,59	30.100,38	455,26	7,25	-	1,00
HC 100 T4 (A6:6) (24º)	9,20	53,59	54,07	32.887,61	485,31	8,45	-	1,00
HC 100 T4 (A6:6) (26º)	9,20	53,08	53,21	35.494,98	509,83	9,62	-	1,00
HC 100 T4 (A6:6) (28º)	11	52,38	52,39	38.029,70	536,50	10,91	-	1,00
HC 100 T4 (A6:6) (30º)	15	50,95	50,87	40.939,63	546,46	12,24	-	1,00
HC 100 T4 (A6:6) (32º)	15	49,27	49,11	43.963,32	553,97	13,69	-	1,00
HC 100 T4 (A6:6) (34º)	15	47,15	46,90	46.811,43	561,60	15,36	-	1,00
HC 100 T4 (A6:6) (36º)	18,50	45,06	44,73	49.461,76	567,01	17,05	-	1,00
HC 100 T4 (A6:6) (38º)	18,50	42,76	42,34	52.080,90	571,48	18,99	-	1,00
HC 100 T4 (A6:6) (40º)	22	41,77	41,28	55.041,76	558,03	20,67	-	1,00
HC 112 T4 (A6:3) (20º)	5,50	51,62	53,62	27.680,89	325,76	4,86	-	1,00
HC 112 T4 (A6:3) (22º)	5,50	53,28	54,80	31.399,79	353,63	5,79	-	1,00
HC 112 T4 (A6:3) (24º)	7,50	54,40	55,49	34.868,01	379,34	6,75	-	1,00
HC 112 T4 (A6:3) (26º)	7,50	52,47	53,11	38.214,74	395,84	8	-	1,00
HC 112 T4 (A6:3) (28º)	9,20	51,01	51,23	41.811,24	410,47	9,32	-	1,00
HC 112 T4 (A6:3) (30º)	11	49,11	49,16	44.804,52	416,14	10,49	-	1,00
HC 112 T4 (A6:3) (32º)	11	46,70	46,65	47.862,69	420,41	11,87	-	1,00
HC 112 T4 (A6:3) (34º)	15	44,24	44,11	50.935,27	420,05	13,29	-	1,00
HC 112 T4 (A6:3) (36º)	15	41,15	40,92	53.371,22	418,21	14,91	-	1,00

Model	Motor power (kW)	Maximum efficiency point data						
		Max. efficiency (%)	Efficiency grade (N) (N)	Air Flow (m3/h)	Ps (Pa)	Pabs (kW)	speed (rpm)	Specific ratio
HC 112 T4 (A6:6) (20º)	9,20	52,45	52,88	32.237,17	498,40	8,60	-	1,00
HC 112 T4 (A6:6) (22º)	11	53,91	53,98	36.703,43	526	10,12	-	1,00
HC 112 T4 (A6:6) (24º)	11	54,22	54,16	40.952,51	556,80	11,89	-	1,00
HC 112 T4 (A6:6) (26º)	15	54,94	54,79	45.443,76	576,54	13,48	-	1,00
HC 112 T4 (A6:6) (28º)	15	54,87	54,62	50.032,67	596,99	15,41	-	1,00
HC 112 T4 (A6:6) (30º)	18,50	54,09	53,74	53.668,11	624,79	17,37	-	1,00
HC 112 T4 (A6:6) (32º)	18,50	52,90	52,46	57.359,42	651,53	19,59	-	1,00
HC 112 T4 (A6:6) (34º)	22	51,41	50,88	60.844,52	672,29	21,86	-	1,00
HC 112 T4 (A6:6) (36º)	30	49,32	48,72	64.237,08	680,21	24,21	-	1,00
HC 112 T4 (A6:6) (38º)	30	47,05	46,37	67.632,83	687,72	26,88	-	1,00
HC 112 T4 (A6:6) (40º)	30	46,14	45,38	72.014,77	673,96	29,65	-	1,00
HC 112 T4 (A6:6) (42º)	37	43,82	42,99	76.396,52	661,82	32,57	-	1,00
HC 125 T4 (A7:4) (20º)	9,20	48,86	49,05	37.436,03	441,89	9,42	-	1,00
HC 125 T4 (A7:4) (22º)	11	51,37	51,38	42.358,02	479,07	11	-	1,00
HC 125 T4 (A7:4) (24º)	15	52,90	52,79	47.318,45	512,60	12,76	-	1,00
HC 125 T4 (A7:4) (26º)	15	52,84	52,62	52.423,63	541,11	14,92	-	1,00
HC 125 T4 (A7:4) (28º)	18,50	53,12	52,78	57.577,02	569,69	17,11	-	1,00
HC 125 T4 (A7:4) (30º)	18,50	51,29	50,85	62.077,08	583,99	19,54	-	1,00
HC 125 T4 (A7:4) (32º)	22	49,53	48,99	66.745,10	597,73	22,17	-	1,00
HC 125 T4 (A7:4) (34º)	30	47,27	46,64	71.395,42	601,89	24,93	-	1,00
HC 125 T4 (A7:4) (36º)	30	44,11	43,40	76.332,49	590,34	27,96	-	1,00
HC 125 T4 (A7:8) (20º)	15	50,18	49,93	41.480,11	669,59	15,48	-	1,00
HC 125 T4 (A7:8) (22º)	18,50	51,20	50,81	47.263,50	710,47	18,37	-	1,00
HC 125 T4 (A7:8) (24º)	22	51,84	51,32	53.481,72	747,25	21,65	-	1,00
HC 125 T4 (A7:8) (26º)	30	52,93	52,30	60.188,52	783,77	25,04	-	1,00
HC 125 T4 (A7:8) (28º)	30	53,56	52,81	66.751,27	824,34	28,90	-	1,00
HC 125 T4 (A7:8) (30º)	37	52,70	51,87	72.110,16	851,08	32,59	-	1,00
HC 125 T4 (A7:8) (32º)	37	51,74	50,81	77.824,27	872,54	36,69	-	1,00
HC 125 T4 (A7:8) (34º)	45	50,39	49,37	83.252,88	893,83	41,06	-	1,00
HC 125 T4 (A7:8) (36º)	45	48,97	47,86	89.032,07	905,02	45,80	-	1,00
HC 125 T4 (A7:8) (38º)	45	46,85	45,66	94.456,41	922,18	51,51	-	1,00
HC 125 T4 (A7:8) (40º)	45	44,93	43,67	99.748,76	914	56,52	-	1,00
HC 125 T4 (A7:8) (42º)	45	42,73	41,39	103.709,46	915,51	61,86	-	1,00

ERP / 6 poles

Model	Motor power (kW)	Maximum efficiency point data						
		Max. efficiency (%)	Efficiency grade (N) (N)	Air Flow (m3/h)	Ps (Pa)	Pabs (kW)	speed (rpm)	Specific ratio
HC 50 T6 (A0:6) (35º)	0,12	29,57	41,28	2.867,25	51,97	0,14	-	1,00
HC 50 T6 (A0:6) (40º)	0,12	29,94	41,22	3.338,73	52,70	0,16	-	1,00
HC 56 T6 (A2:6) (20º)	0,12	30,59	41,95	2.771,99	63,19	0,16	-	1,00
HC 56 T6 (A2:6) (25º)	0,18	33,64	44,32	3.510,42	69,95	0,20	-	1,00
HC 56 T6 (A2:6) (27,5º)	0,18	33,58	44,05	3.672,17	72,19	0,22	-	1,00
HC 56 T6 (A2:6) (30º)	0,18	33,07	43,05	4.094,24	76,36	0,26	-	1,00
HC 56 T6 (A2:6) (32,5º)	0,25	34,17	43,98	4.410,09	78,51	0,28	-	1,00
HC 56 T6 (A2:6) (35º)	0,25	33,16	42,64	4.753,82	79,97	0,32	-	1,00
HC 56 T6 (A2:6) (37,5º)	0,25	32,61	41,83	5.109,35	79,65	0,35	-	1,00
HC 56 T6 (A2:6) (40º)	0,37	32,38	41,38	5.477,76	79,60	0,38	-	1,00
HC 56 T6 (A2:6) (42,5º)	0,37	29,79	38,49	6.063,41	73,94	0,42	-	1,00
HC 56 T6 (A2:6) (45º)	0,37	28,45	37,02	6.336,33	71,31	0,44	-	1,00
HC 56 T6 (A2:9) (20º)	0,18	32,36	43,06	2.917,65	79,10	0,20	-	1,00
HC 56 T6 (A2:9) (25º)	0,18	34,39	44,35	3.702,61	86,91	0,27	-	1,00
HC 56 T6 (A2:9) (27,5º)	0,25	36,31	46,20	3.951,84	88,63	0,27	-	1,00
HC 56 T6 (A2:9) (30º)	0,25	35,75	45,12	4.510,27	93,49	0,33	-	1,00
HC 56 T6 (A2:9) (32,5º)	0,37	34,99	44,07	4.818,14	96,05	0,37	-	1,00
HC 56 T6 (A2:9) (35º)	0,37	34,45	43,28	5.132,65	97,84	0,40	-	1,00
HC 56 T6 (A2:9) (37,5º)	0,37	34,47	43,06	5.486,25	98,22	0,44	-	1,00
HC 56 T6 (A2:9) (40º)	0,37	33,80	42,16	5.891,27	97,63	0,48	-	1,00
HC 56 T6 (A2:9) (42,5º)	0,55	33,44	41,50	6.312,41	100,05	0,53	-	1,00
HC 56 T6 (A2:9) (45º)	0,55	33,24	41,16	6.581,44	100,16	0,56	-	1,00
HC 56 T6 (A5:6) (20º)	0,18	33,88	45,04	2.997,08	69,69	0,17	-	1,00
HC 56 T6 (A5:6) (25º)	0,18	37,02	47,69	3.891,87	69,84	0,21	-	1,00
HC 56 T6 (A5:6) (30º)	0,18	38,62	48,87	4.549,65	71,87	0,24	-	1,00
HC 56 T6 (A5:6) (35º)	0,25	39,16	48,97	5.292,56	75,56	0,28	-	1,00
HC 56 T6 (A5:6) (40º)	0,37	32,85	41,65	6.088,13	80,50	0,41	-	1,00
HC 56 T6 (A5:6) (45º)	0,37	30,05	38,30	6.605,52	82,14	0,50	-	1,00
HC 63 T6 (A2:6) (20º)	0,37	33,20	43,94	3.629,47	65,51	0,20	-	1,00
HC 63 T6 (A2:6) (25º)	0,37	36,82	46,77	4.713,19	74,55	0,27	-	1,00
HC 63 T6 (A2:6) (27,5º)	0,37	37,51	47,25	5.012,22	77,23	0,29	-	1,00
HC 63 T6 (A2:6) (30º)	0,37	38,56	47,81	5.691,23	83,66	0,34	-	1,00
HC 63 T6 (A2:6) (32,5º)	0,37	38,10	47,01	6.161,12	86,82	0,39	-	1,00
HC 63 T6 (A2:6) (35º)	0,37	37,41	45,99	6.649,29	89,61	0,44	-	1,00
HC 63 T6 (A2:6) (37,5º)	0,37	36,52	44,82	7.082,78	91,09	0,49	-	1,00
HC 63 T6 (A2:6) (40º)	0,55	36,28	44,33	7.515,99	92,50	0,53	-	1,00
HC 63 T6 (A2:6) (42,5º)	0,55	36,01	43,88	8.469,61	86,36	0,57	-	1,00
HC 63 T6 (A2:6) (45º)	0,55	35,30	43,08	8.933,54	83,22	0,59	-	1,00
HC 63 T6 (A2:9) (20º)	0,37	36,71	46,56	3.974,97	90,06	0,28	-	1,00

Model	Motor power (kW)	Maximum efficiency point data						
		Max. efficiency (%)	Efficiency grade (N) (N)	Air Flow (m3/h)	Ps (Pa)	Pabs (kW)	speed (rpm)	Specific ratio
HC 63 T6 (A2:9) (25º)	0,37	39,82	48,97	5.176,19	97,61	0,36	-	1,00
HC 63 T6 (A2:9) (27,5º)	0,37	40,20	49,10	5.520,02	101,08	0,39	-	1,00
HC 63 T6 (A2:9) (30º)	0,37	40,57	48,92	6.329,06	108,71	0,48	-	1,00
HC 63 T6 (A2:9) (32,5º)	0,55	39,96	47,97	6.828,85	112,96	0,54	-	1,00
HC 63 T6 (A2:9) (35º)	0,55	39,10	46,77	7.347,39	117,12	0,61	-	1,00
HC 63 T6 (A2:9) (37,5º)	0,55	38,34	45,76	7.815,16	118,58	0,67	-	1,00
HC 63 T6 (A2:9) (40º)	0,75	38,87	46,11	8.319,23	119,52	0,72	-	1,00
HC 63 T6 (A2:9) (42,5º)	0,75	37,80	44,76	9.247,46	115,29	0,79	-	1,00
HC 63 T6 (A2:9) (45º)	0,75	37,18	44,01	9.652,81	114,15	0,83	-	1,00
HC 63 T6 (A5:6) (20º)	0,37	43,66	54,06	4.259,40	81,62	0,23	-	1,00
HC 63 T6 (A5:6) (25º)	0,37	44,74	54,51	5.182,49	85,62	0,29	-	1,00
HC 63 T6 (A5:6) (30º)	0,37	42,19	50,85	6.348,01	100,49	0,43	-	1,00
HC 63 T6 (A5:6) (35º)	0,55	40,11	48,27	7.141,60	103,35	0,51	-	1,00
HC 63 T6 (A5:6) (40º)	0,55	37,14	44,66	8.305,28	104,67	0,65	-	1,00
HC 63 T6 (A5:6) (45º)	0,75	34,12	41,24	9.329,94	97,42	0,75	-	1,00
HC 71 T6 (A2:6) (20º)	0,37	38,28	48,31	4.675,80	76,12	0,26	-	1,00
HC 71 T6 (A2:6) (25º)	0,37	41,86	50,96	6.302,13	86,22	0,36	-	1,00
HC 71 T6 (A2:6) (27,5º)	0,37	42,18	51,03	6.825,43	88,07	0,40	-	1,00
HC 71 T6 (A2:6) (30º)	0,37	42,25	50,50	7.907,34	94,60	0,50	-	1,00
HC 71 T6 (A2:6) (32,5º)	0,55	42,27	50,20	8.581,39	98,81	0,56	-	1,00
HC 71 T6 (A2:6) (35º)	0,55	41,80	49,37	9.218,05	103,99	0,64	-	1,00
HC 71 T6 (A2:6) (37,5º)	0,55	40,83	48,16	9.982,19	101,58	0,69	-	1,00
HC 71 T6 (A2:6) (40º)	0,75	40,25	47,37	10.642,65	101,62	0,75	-	1,00
HC 71 T6 (A2:6) (42,5º)	0,75	37,86	44,64	11.879,86	96,12	0,85	-	1,00
HC 71 T6 (A2:6) (45º)	0,75	36,79	43,42	12.385,29	94,66	0,90	-	1,00
HC 71 T6 (A2:9) (20º)	0,37	41,10	50,29	4.945,90	104,43	0,35	-	1,00
HC 71 T6 (A2:9) (25º)	0,37	44,09	52,42	6.881,58	108,73	0,48	-	1,00
HC 71 T6 (A2:9) (27,5º)	0,55	44,56	52,65	7.358,35	112,21	0,53	-	1,00
HC 71 T6 (A2:9) (30º)	0,55	44,36	51,88	8.445,90	120,61	0,65	-	1,00
HC 71 T6 (A2:9) (32,5º)	0,75	44,56	51,78	9.214,12	124,07	0,72	-	1,00
HC 71 T6 (A2:9) (35º)	0,75	43,34	50,18	9.993,72	127,42	0,83	-	1,00
HC 71 T6 (A2:9) (37,5º)	0,75	41,82	48,34	10.718,70	130,12	0,93	-	1,00
HC 71 T6 (A2:9) (40º)	1,10	41,50	47,79	11.635,72	130,18	1,01	-	1,00
HC 71 T6 (A2:9) (42,5º)	1,10	39,68	45,67	12.454,44	129,23	1,13	-	1,00
HC 71 T6 (A2:9) (45º)	1,10	38,82	44,67	13.031,81	127	1,19	-	1,00
HC 71 T6 (A5:6) (20º)	0,37	46,14	55,71	5.581,71	88,88	0,31	-	1,00
HC 71 T6 (A5:6) (25º)	0,37	43,71	52,26	6.947,87	98,30	0,44	-	1,00
HC 71 T6 (A5:6) (30º)	0,55	44,18	52,02	8.342,39	107,60	0,58	-	1,00

Model	Motor power (kW)	Maximum efficiency point data						
		Max. efficiency (%)	Efficiency grade (N) (N)	Air Flow (m3/h)	Ps (Pa)	Pabs (kW)	speed (rpm)	Specific ratio
HC 71 T6 (A5:6) (35º)	0,75	41,45	48,50	9.873,98	114,96	0,77	-	1,00
HC 71 T6 (A5:6) (40º)	0,75	38,28	44,88	10.996,52	113,94	0,91	-	1,00
HC 71 T6 (A5:6) (45º)	1,10	34,26	40,38	12.355,45	107,34	1,08	-	1,00
HC 80 T6 (A2:6) (20º)	0,75	43,87	53,32	5.869,64	85,92	0,32	-	1,00
HC 80 T6 (A2:6) (25º)	0,75	46,73	55,17	8.428,22	91,78	0,46	-	1,00
HC 80 T6 (A2:6) (27,5º)	0,75	47,37	55,53	9.025,78	96,48	0,51	-	1,00
HC 80 T6 (A2:6) (30º)	0,75	47,17	54,66	10.572,62	104,25	0,65	-	1,00
HC 80 T6 (A2:6) (32,5º)	0,75	46,74	53,84	11.676,45	108,10	0,76	-	1,00
HC 80 T6 (A2:6) (35º)	0,75	45,66	52,37	12.709,28	111,98	0,87	-	1,00
HC 80 T6 (A2:6) (37,5º)	1,10	44,39	50,81	13.500,43	115	0,97	-	1,00
HC 80 T6 (A2:6) (40º)	1,10	42,01	48,08	14.381,77	116,95	1,10	-	1,00
HC 80 T6 (A2:6) (42,5º)	1,10	38,80	44,38	15.773,02	114,58	1,31	-	1,00
HC 80 T6 (A2:6) (45º)	1,50	37,84	43,27	16.674,15	111,89	1,39	-	1,00
HC 80 T6 (A2:9) (20º)	0,75	46,31	54,80	6.435,84	116,89	0,46	-	1,00
HC 80 T6 (A2:9) (25º)	0,75	47,84	55,29	9.202,40	121,51	0,66	-	1,00
HC 80 T6 (A2:9) (27,5º)	0,75	47,57	54,75	9.873,19	124,39	0,73	-	1,00
HC 80 T6 (A2:9) (30º)	0,75	47,20	53,79	11.569,36	131,24	0,91	-	1,00
HC 80 T6 (A2:9) (32,5º)	1,10	45,84	51,99	12.707,55	136,89	1,07	-	1,00
HC 80 T6 (A2:9) (35º)	1,10	42,87	48,51	13.882,14	141,44	1,29	-	1,00
HC 80 T6 (A2:9) (37,5º)	1,50	42,94	48,33	14.868,76	145,92	1,41	-	1,00
HC 80 T6 (A2:9) (40º)	1,50	41,74	46,84	15.689,22	150,60	1,57	-	1,00
HC 80 T6 (A2:9) (42,5º)	2,20	40,76	45,55	17.313,51	147,18	1,76	-	1,00
HC 80 T6 (A2:9) (45º)	2,20	39,71	44,33	18.133,18	145,20	1,86	-	1,00
HC 80 T6 (A5:6) (20º)	0,75	44,10	52,71	6.478,97	106,45	0,44	-	1,00
HC 80 T6 (A5:6) (25º)	0,75	46,78	54,69	8.237,88	113,78	0,56	-	1,00
HC 80 T6 (A5:6) (30º)	0,75	51,64	58,49	11.507,70	132,45	0,83	-	1,00
HC 80 T6 (A5:6) (35º)	1,10	47,12	53,31	13.246,54	135	1,05	-	1,00
HC 80 T6 (A5:6) (40º)	1,10	44,42	49,99	14.989,74	141,31	1,32	-	1,00
HC 80 T6 (A5:6) (45º)	1,50	38,67	43,70	17.074,55	130,65	1,61	-	1,00
HC 90 T6 (A6:3) (20º)	0,75	42,93	50,01	11.655,62	100,63	0,76	-	1,00
HC 90 T6 (A6:3) (22º)	0,75	42,80	49,44	12.594,45	109,28	0,89	-	1,00
HC 90 T6 (A6:3) (24º)	1,10	43,84	50,15	13.636	117,21	1,01	-	1,00
HC 90 T6 (A6:3) (26º)	1,10	42,79	48,70	14.329,80	125,47	1,16	-	1,00
HC 90 T6 (A6:3) (28º)	1,10	41,84	47,39	15.114,86	133,70	1,33	-	1,00
HC 90 T6 (A6:3) (30º)	1,50	40,66	45,93	16.331,72	133,18	1,47	-	1,00
HC 90 T6 (A6:3) (32º)	1,50	38,39	43,35	17.530,96	131,64	1,65	-	1,00
HC 90 T6 (A6:3) (34º)	2,20	36,96	41,65	18.745,80	130,07	1,82	-	1,00
HC 90 T6 (A6:3) (36º)	2,20	34,53	38,90	19.855,62	129,62	2,05	-	1,00

Model	Motor power (kW)	Maximum efficiency point data						
		Max. efficiency (%)	Efficiency grade (N) (N)	Air Flow (m3/h)	Ps (Pa)	Pabs (kW)	speed (rpm)	Specific ratio
HC 90 T6 (A6:3) (38º)	2,20	32,03	36,07	21.084,47	127,51	2,31	-	1,00
HC 90 T6 (A6:6) (20º)	1,10	45,95	51,67	13.525,17	151,01	1,25	-	1,00
HC 90 T6 (A6:6) (22º)	1,50	46,77	52,10	14.868,57	161,48	1,44	-	1,00
HC 90 T6 (A6:6) (24º)	1,50	46,22	51,13	16.093,63	171,86	1,68	-	1,00
HC 90 T6 (A6:6) (26º)	2,20	45,82	50,38	17.106,27	181,43	1,91	-	1,00
HC 90 T6 (A6:6) (28º)	2,20	44,51	48,69	18.062,80	192,50	2,19	-	1,00
HC 90 T6 (A6:6) (30º)	2,20	43,01	46,85	19.133,80	199,01	2,48	-	1,00
HC 90 T6 (A6:6) (32º)	3	41,87	45,43	20.023,73	206,31	2,75	-	1,00
HC 90 T6 (A6:6) (34º)	3	40,22	43,49	21.166,24	209,08	3,05	-	1,00
HC 90 T6 (A6:6) (36º)	3	39,29	42,30	22.377,36	211,71	3,36	-	1,00
HC 90 T6 (A6:6) (38º)	4	39,34	42,15	23.811,79	212,36	3,62	-	1,00
HC 90 T6 (A6:6) (40º)	4	37,28	39,86	25.355,53	205,24	3,94	-	1,00
HC 100 T6 (A6:3) (20º)	1,10	48,66	54,82	15.269,87	121,92	1,07	-	1,00
HC 100 T6 (A6:3) (22º)	1,10	48,55	54,22	16.701,36	132,54	1,27	-	1,00
HC 100 T6 (A6:3) (24º)	1,50	48,84	54,12	17.985,64	142,77	1,46	-	1,00
HC 100 T6 (A6:3) (26º)	1,50	47,23	52,10	19.152,33	150,97	1,70	-	1,00
HC 100 T6 (A6:3) (28º)	2,20	46,96	51,52	20.236,81	159,70	1,91	-	1,00
HC 100 T6 (A6:3) (30º)	2,20	44,55	48,78	21.822,21	158,77	2,15	-	1,00
HC 100 T6 (A6:3) (32º)	2,20	41,76	45,65	23.575,66	155,94	2,43	-	1,00
HC 100 T6 (A6:3) (34º)	3	39,70	43,32	25.358,26	153,43	2,69	-	1,00
HC 100 T6 (A6:3) (36º)	3	36,69	40,02	26.972,39	148,05	3	-	1,00
HC 100 T6 (A6:3) (38º)	3	34,56	37,59	29.161,39	141,13	3,34	-	1,00
HC 100 T6 (A6:6) (20º)	2,20	49,96	54,72	17.486,79	179,25	1,77	-	1,00
HC 100 T6 (A6:6) (22º)	2,20	50,10	54,39	19.498,64	190,85	2,11	-	1,00
HC 100 T6 (A6:6) (24º)	2,20	49,98	53,83	21.348,84	203,68	2,47	-	1,00
HC 100 T6 (A6:6) (26º)	3	50,17	53,72	22.968,11	214,14	2,76	-	1,00
HC 100 T6 (A6:6) (28º)	3	49,07	52,24	24.613,37	225,37	3,16	-	1,00
HC 100 T6 (A6:6) (30º)	4	48,03	50,91	26.508	229,19	3,53	-	1,00
HC 100 T6 (A6:6) (32º)	4	46,33	48,89	28.489,87	232,14	3,96	-	1,00
HC 100 T6 (A6:6) (34º)	4	44,41	46,65	30.354,18	235,59	4,44	-	1,00
HC 100 T6 (A6:6) (36º)	5,50	42,72	44,70	32.077,28	237,53	4,89	-	1,00
HC 100 T6 (A6:6) (38º)	5,50	40,60	42,28	33.810,22	240,04	5,45	-	1,00
HC 100 T6 (A6:6) (40º)	5,50	39,49	40,94	35.779	233,18	5,94	-	1,00
HC 100 T6 (A6:6) (42º)	7,50	37,87	39,14	37.513,81	227,81	6,34	-	1,00
HC 112 T6 (A6:3) (20º)	1,50	47,85	53,21	17.858,55	137,35	1,43	-	1,00
HC 112 T6 (A6:3) (22º)	1,50	49,36	54,23	20.267,63	149,43	1,71	-	1,00
HC 112 T6 (A6:3) (24º)	2,20	50,73	55,20	22.635,90	158,75	1,97	-	1,00
HC 112 T6 (A6:3) (26º)	2,20	49,11	53,13	24.842,09	165,68	2,33	-	1,00

Model	Motor power (kW)	Maximum efficiency point data						
		Max. efficiency (%)	Efficiency grade (N) (N)	Air Flow (m3/h)	Ps (Pa)	Pabs (kW)	speed (rpm)	Specific ratio
HC 112 T6 (A6:3) (28º)	3	48,25	51,88	27.083,62	172,28	2,68	-	1,00
HC 112 T6 (A6:3) (30º)	3	46,21	49,50	29.004,93	175,13	3,04	-	1,00
HC 112 T6 (A6:3) (32º)	3	43,72	46,65	31.060,32	176,18	3,45	-	1,00
HC 112 T6 (A6:3) (34º)	4	41,66	44,31	32.962,45	176,55	3,84	-	1,00
HC 112 T6 (A6:3) (36º)	4	38,64	40,97	34.545,12	175,66	4,32	-	1,00
HC 112 T6 (A6:3) (38º)	5,50	36,34	38,39	36.455,29	173,36	4,78	-	1,00
HC 112 T6 (A6:6) (20º)	2,20	48,67	52,47	20.848	209,34	2,52	-	1,00
HC 112 T6 (A6:6) (22º)	3	50,69	54,07	23.752,54	221,76	2,93	-	1,00
HC 112 T6 (A6:6) (24º)	3	50,81	53,75	26.484,45	234,27	3,45	-	1,00
HC 112 T6 (A6:6) (26º)	4	51,68	54,29	29.506,12	241,29	3,90	-	1,00
HC 112 T6 (A6:6) (28º)	4	51,64	53,87	32.443,65	250,25	4,45	-	1,00
HC 112 T6 (A6:6) (30º)	5,50	51,28	53,21	34.808,90	261,77	4,98	-	1,00
HC 112 T6 (A6:6) (32º)	5,50	50,14	51,74	37.132,25	273,49	5,62	-	1,00
HC 112 T6 (A6:6) (34º)	7,50	49,60	50,95	39.423,52	282,46	6,17	-	1,00
HC 112 T6 (A6:6) (36º)	7,50	47,28	48,33	41.617,76	285,29	6,87	-	1,00
HC 112 T6 (A6:6) (38º)	7,50	45,02	45,78	43.738,41	289,26	7,64	-	1,00
HC 112 T6 (A6:6) (40º)	11	44,42	44,92	46.645,30	283,18	8,38	-	1,00
HC 112 T6 (A6:6) (42º)	11	42,03	42,27	49.498,53	277,92	9,24	-	1,00
HC 125 T6 (A7:4) (20º)	3	46,31	49,91	24.233,19	185,89	2,71	-	1,00
HC 125 T6 (A7:4) (22º)	3	48,21	51,36	27.403,92	201,73	3,19	-	1,00
HC 125 T6 (A7:4) (24º)	4	49,90	52,66	30.566,95	216,22	3,69	-	1,00
HC 125 T6 (A7:4) (26º)	4	49,67	51,99	33.888,81	227,55	4,32	-	1,00
HC 125 T6 (A7:4) (28º)	5,50	50,32	52,28	37.240,81	239,65	4,92	-	1,00
HC 125 T6 (A7:4) (30º)	5,50	48,74	50,35	40.177,12	245,56	5,59	-	1,00
HC 125 T6 (A7:4) (32º)	7,50	47,70	49	43.209,79	251,25	6,26	-	1,00
HC 125 T6 (A7:4) (34º)	7,50	45,32	46,29	46.312,63	252,25	7,07	-	1,00
HC 125 T6 (A7:4) (36º)	7,50	42,35	43	49.665,35	247,58	7,95	-	1,00
HC 125 T6 (A7:8) (20º)	4	47,06	49,27	26.696,21	283,54	4,49	-	1,00
HC 125 T6 (A7:8) (22º)	5,50	48,56	50,34	30.645,08	297,68	5,26	-	1,00
HC 125 T6 (A7:8) (24º)	7,50	49,95	51,32	34.677,46	313,95	6,11	-	1,00
HC 125 T6 (A7:8) (26º)	7,50	50,74	51,70	38.941,53	329,25	7,10	-	1,00
HC 125 T6 (A7:8) (28º)	7,50	51,29	51,84	43.274,16	346,56	8,23	-	1,00
HC 125 T6 (A7:8) (30º)	11	50,67	50,91	46.803,60	357,08	9,23	-	1,00
HC 125 T6 (A7:8) (32º)	11	49,60	49,65	50.345,14	366,45	10,38	-	1,00
HC 125 T6 (A7:8) (34º)	11	48,50	48,47	54.072,65	373,66	11,61	-	1,00
HC 125 T6 (A7:8) (36º)	15	47,63	47,52	57.707,96	379,39	12,79	-	1,00
HC 125 T6 (A7:8) (38º)	15	45,59	45,39	61.565,16	384,24	14,45	-	1,00
HC 125 T6 (A7:8) (40º)	15	43,46	43,18	64.341,26	384,84	15,88	-	1,00

Model	Motor power (kW)	Maximum efficiency point data						
		Max. efficiency (%)	Efficiency grade (N) (N)	Air Flow (m ³ /h)	Ps (Pa)	Pabs (kW)	speed (rpm)	Specific ratio
HC 125 T6 (A7:8) (42°)	15	41,62	41,27	67.617,95	381,61	17,38	-	1,00