

ENKELFAN EEC

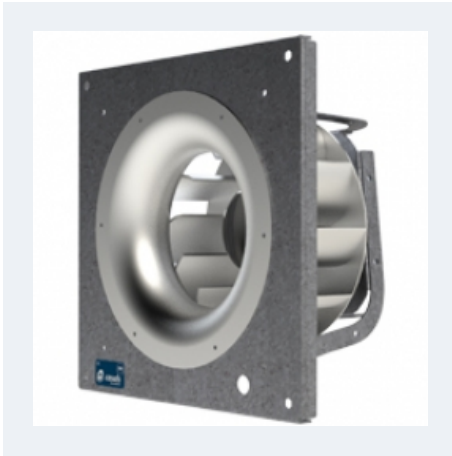

CENTRIFUGAL FAN WITH EXTERNAL ROTOR EC MOTOR

MANUFACTURING FEATURES

Plug-type fan with self-cleaning impeller with back curved blades (backward), high performance and single inlet, direct driven. Dynamically balanced to minimize noise and vibration. Polyamide reinforced impeller for models 155 and 190 and aluminum plate for the rest.

High efficiency, low noise external rotor EC motor. Speed control through a 0-10V or PWM signal. Single-phase 230V 50 / 60Hz power supply for models 155 to 310 and three-phase 400V 50 / 60Hz for sizes 355 and 450. IP44 motor and class B insulation.

Frame and motor support arms made of galvanized steel.

APPLICATIONS

Air conditioners, plenums.

Working temperature range from -20°C to 60°C.

UNDER REQUEST

- Fan (size between 250 and 450) with k-factor reading.

Technical data

Single-phase motor

Code	Model	R.P.M.	Rated I. A 230V	Rated power kW	Max. Airflow m ³ /h	Sound db (A)**	Weight kg	Connect. diagram
ENKEC155	ENKELFAN 155 EEC	3950	0,25	0,06	460	-	3	1
ENKEC190	ENKELFAN 190 EEC	3570	0,73	0,10	760	-	4,50	1
ENKEC250	ENKELFAN 250 EEC	2500	1,00	0,15	1.640	-	7,50	1
ENKEC310	ENKELFAN 310 EEC	2350	1,7	0,36	3.160	-	13	1

Three-phase motor

Code	Model	R.P.M.	Rated I. A 400V	Rated power kW	Max. Airflow m ³ /h	Sound db (A)**	Weight kg	Connect. diagram
ENKEC355	ENKELFAN 355 EEC	2100	1,63	0,99	4.890	-	17,50	2
ENKEC450	ENKELFAN 450 EEC	1450	1,67	1,01	6.955	-	26	2

Notes:

** Total sound pressure level at the point of maximum flow measured in dB(A) in the suction measured in free field at a distance of 6m from the source

Dimensions

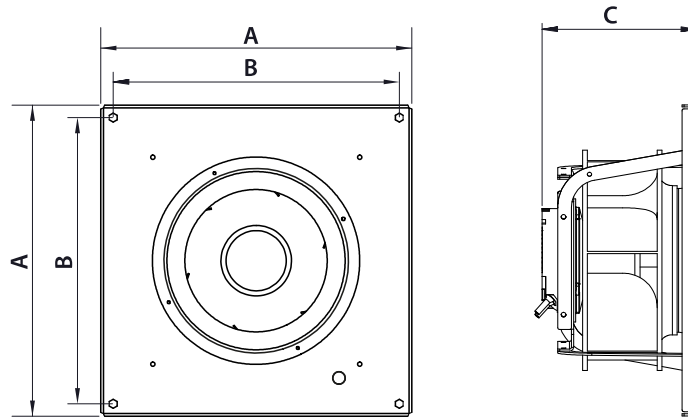

Model	A	B	C
ENKELFAN 155 EEC	220	184	106.5
ENKELFAN 190 EEC	280	244	106.5
ENKELFAN 250 EEC	355	319	200
ENKELFAN 310 EEC	450	414	223.7
ENKELFAN 355 EEC	500	454.8	321.5
ENKELFAN 450 EEC	630	583	381

Wiring diagram

DIAGRAM Nº 1

Nº	Signal Señal	Colour Color	Specification Especificación
1	L	Brown Marrón	AC 220V/50Hz
2	N	Blue Azul	AC 220V/50Hz
3	Pe	Yellow-Green Amarillo-Verde	



Nº	Signal Señal	Colour Color	Specification Especificación
1	GND	Blue Azul	
2	Vsp	Yellow Amarillo	0-10 V/PWM
3	Vcc	Red Rojo	DC 10V
4	FG	White Blanco	1 Pulse/R

DIAGRAM Nº 2

Nº	Signal Señal	Colour Color	Specification Especificación
1	L1	Black Negro	AC380V/50Hz
2	L2	Black Negro	AC380V/50Hz
3	L3	Black Negro	AC380V/50Hz
4	Pe	Yellow-Green Amarillo-Verde	

Nº	Signal Señal	Colour Color	Specification Especificación
1	Vcc	Red Rojo	DC10V
2	Vsp	Yellow Amarillo	0-10VDC/PWM
3	GND	Blue Azul	
4	FG	White Blanco	1 Pulse/R

CHARACTERISCTIC CURVE

ENKELFAN 155 EEC

AIR FLOW - PRESSURE

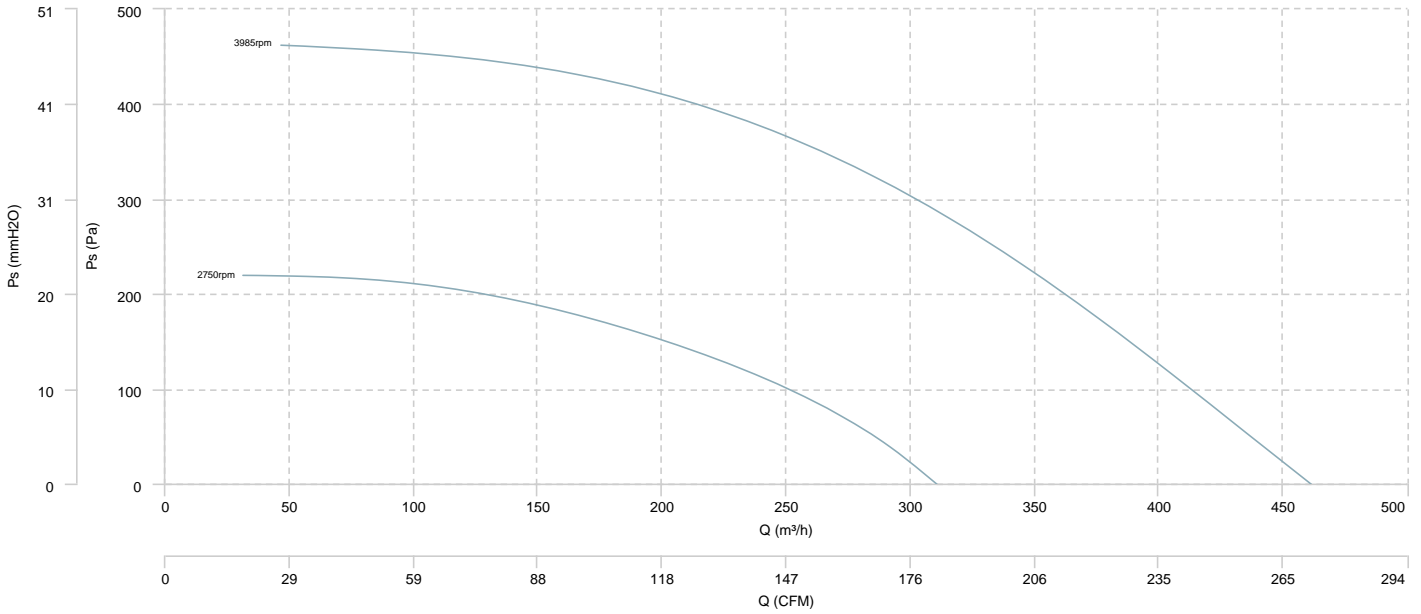

AIR FLOW - MECHANICAL POWER

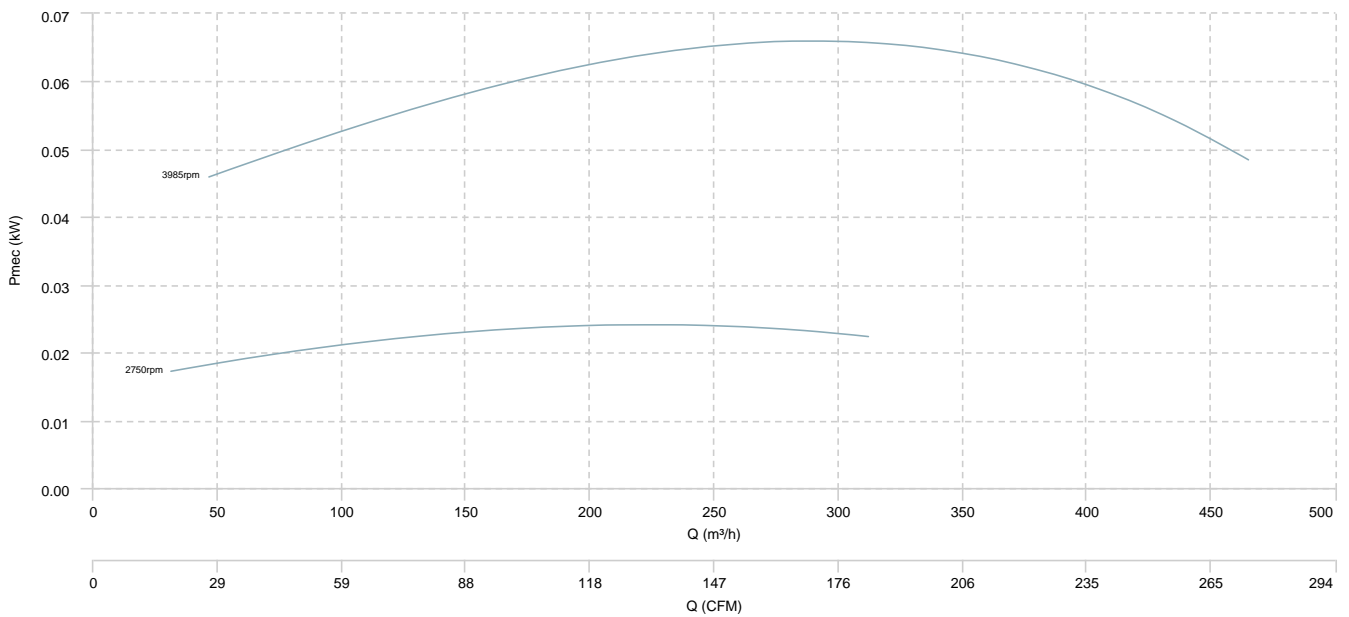

ENKELFAN 190 EEC

AIR FLOW - PRESSURE

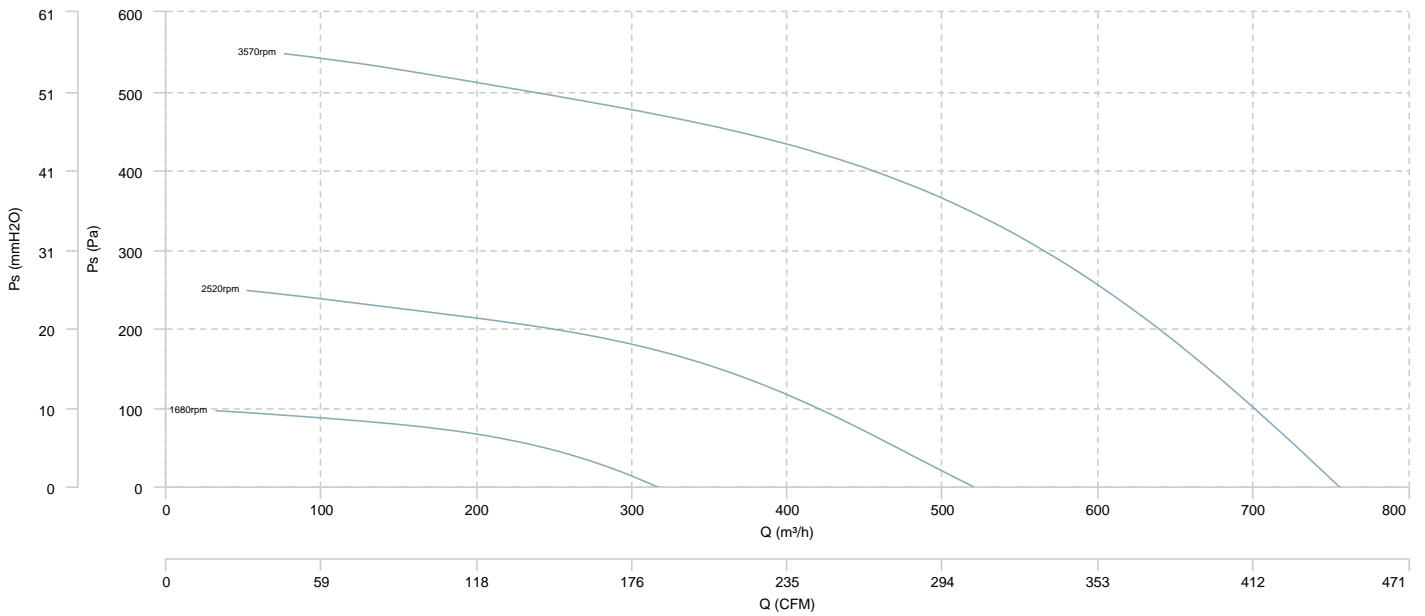

AIR FLOW - MECHANICAL POWER

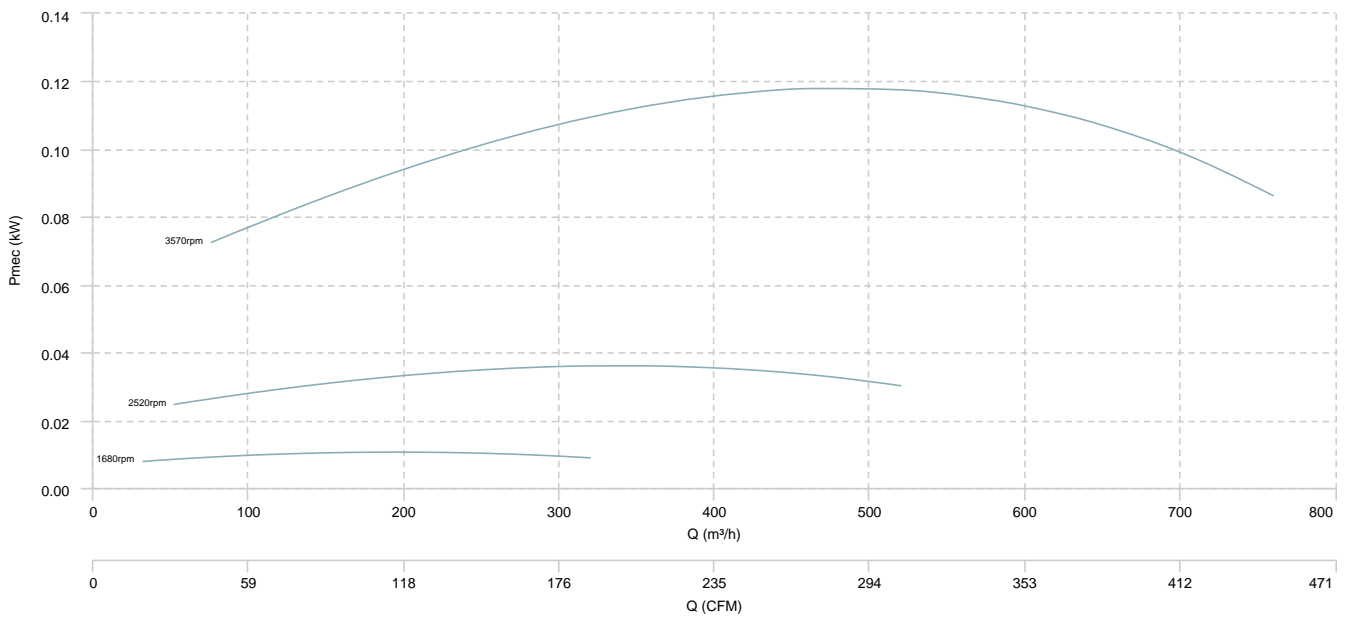

ENKELFAN 250 EEC

AIR FLOW - PRESSURE

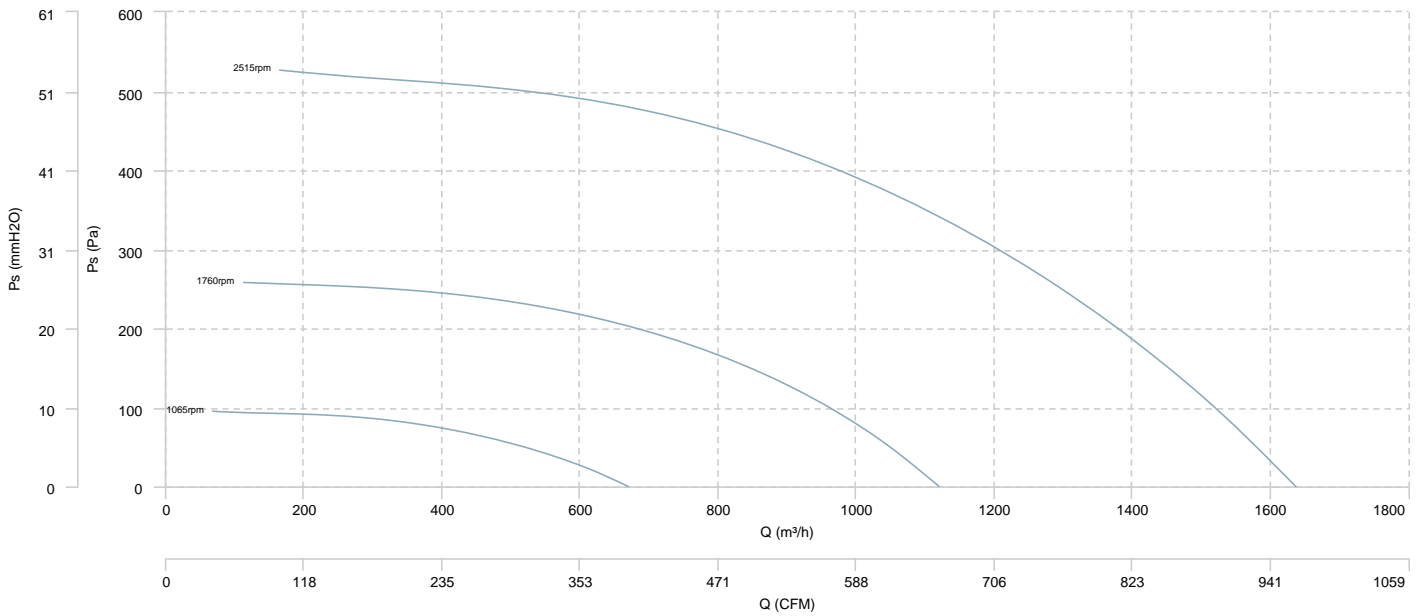

AIR FLOW - MECHANICAL POWER

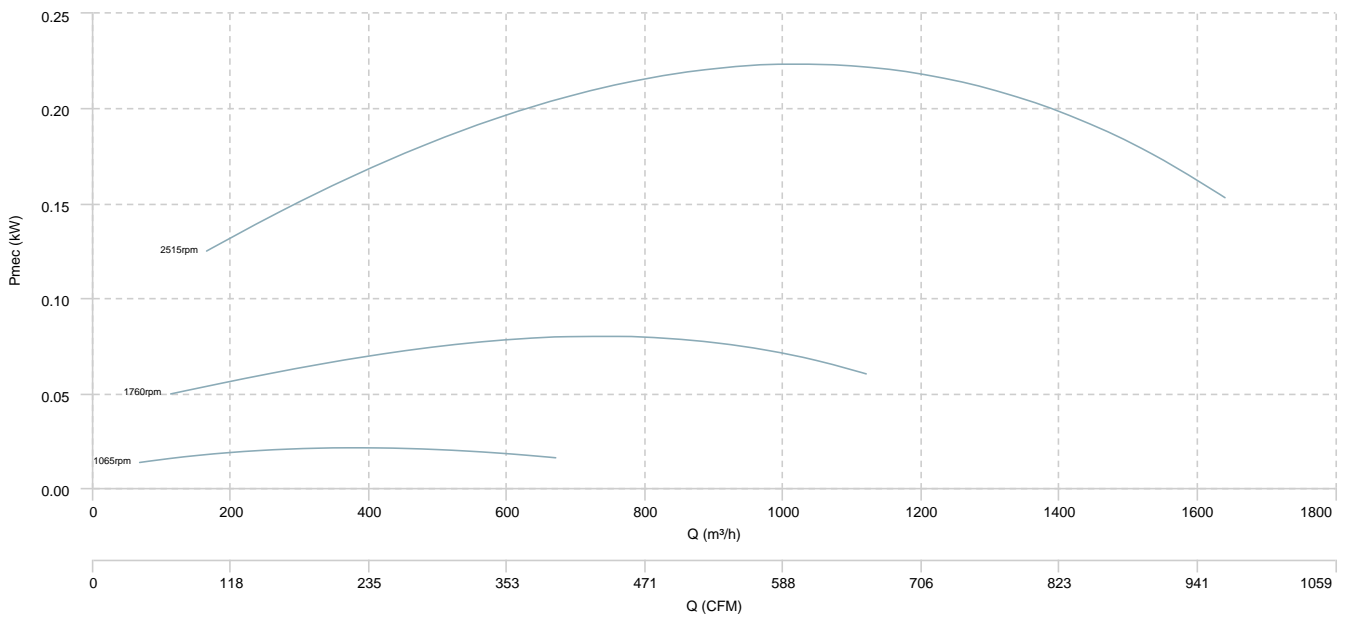

ENKELFAN 310 EEC

AIR FLOW - PRESSURE

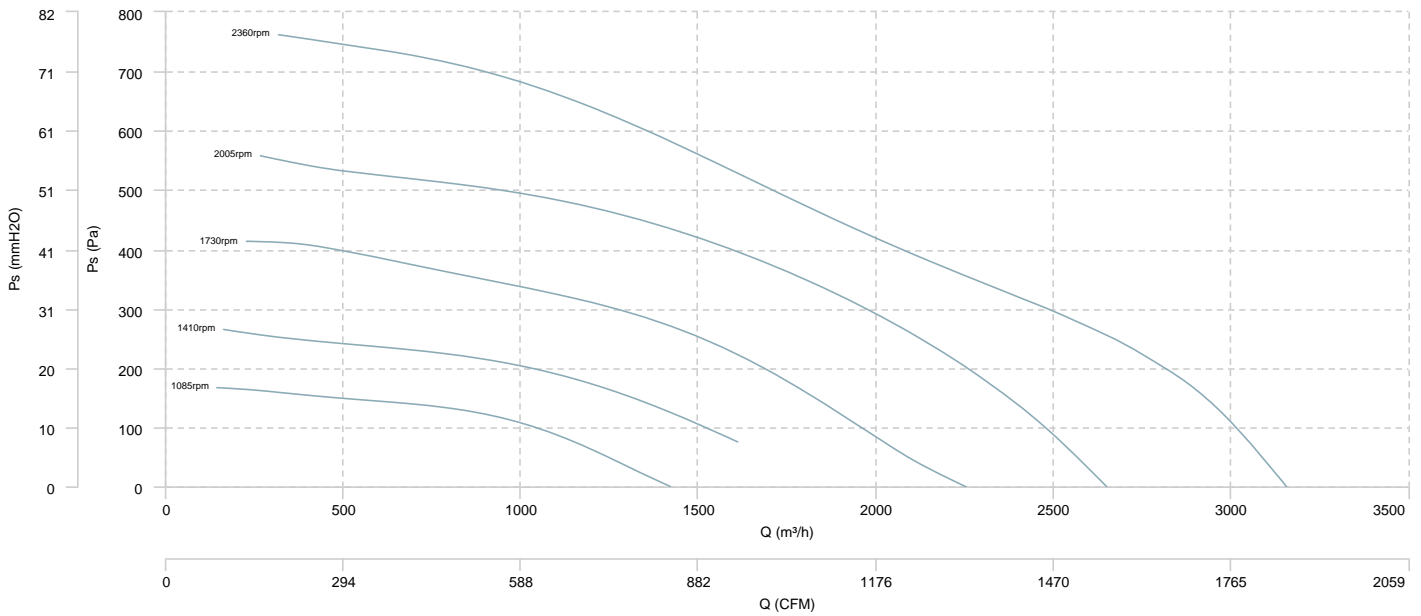

AIR FLOW - MECHANICAL POWER

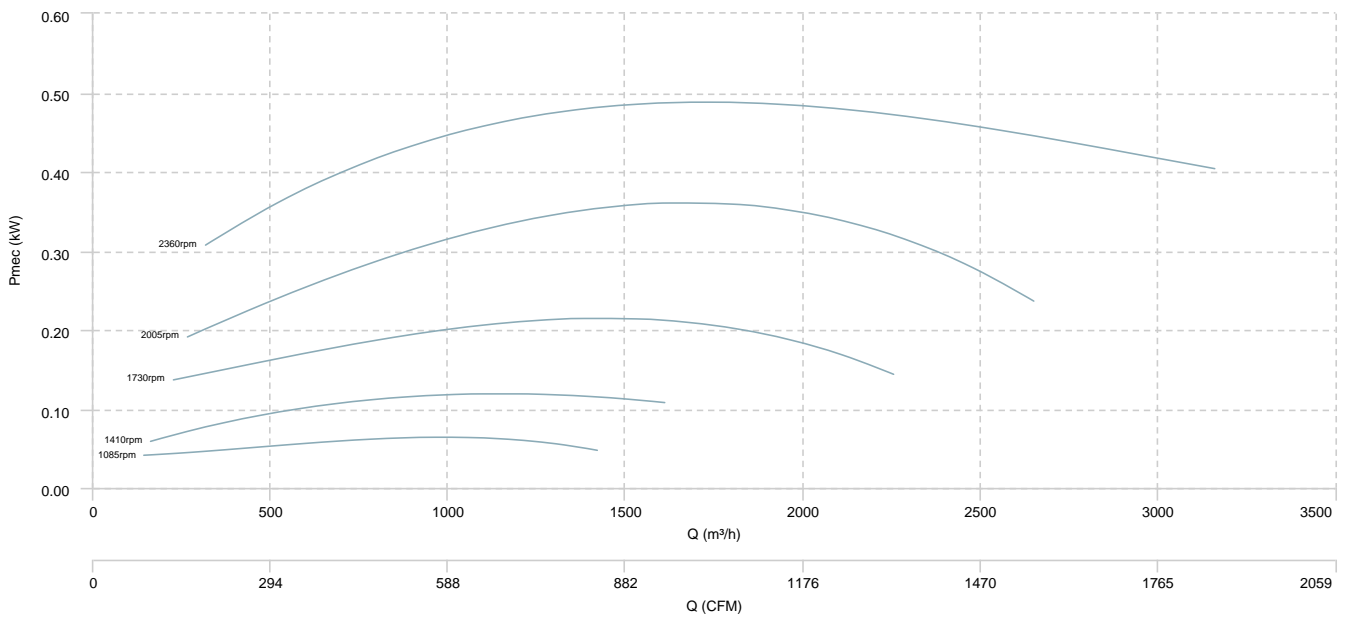

ENKELFAN 355 EEC

AIR FLOW - PRESSURE

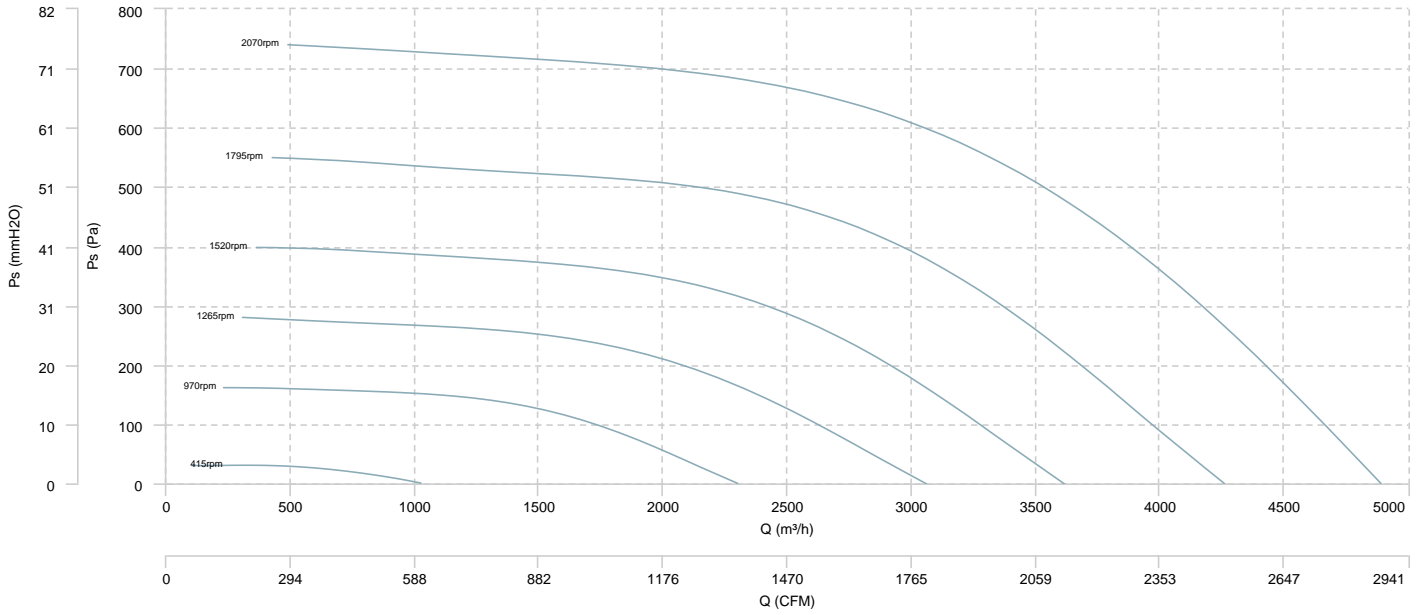

AIR FLOW - MECHANICAL POWER

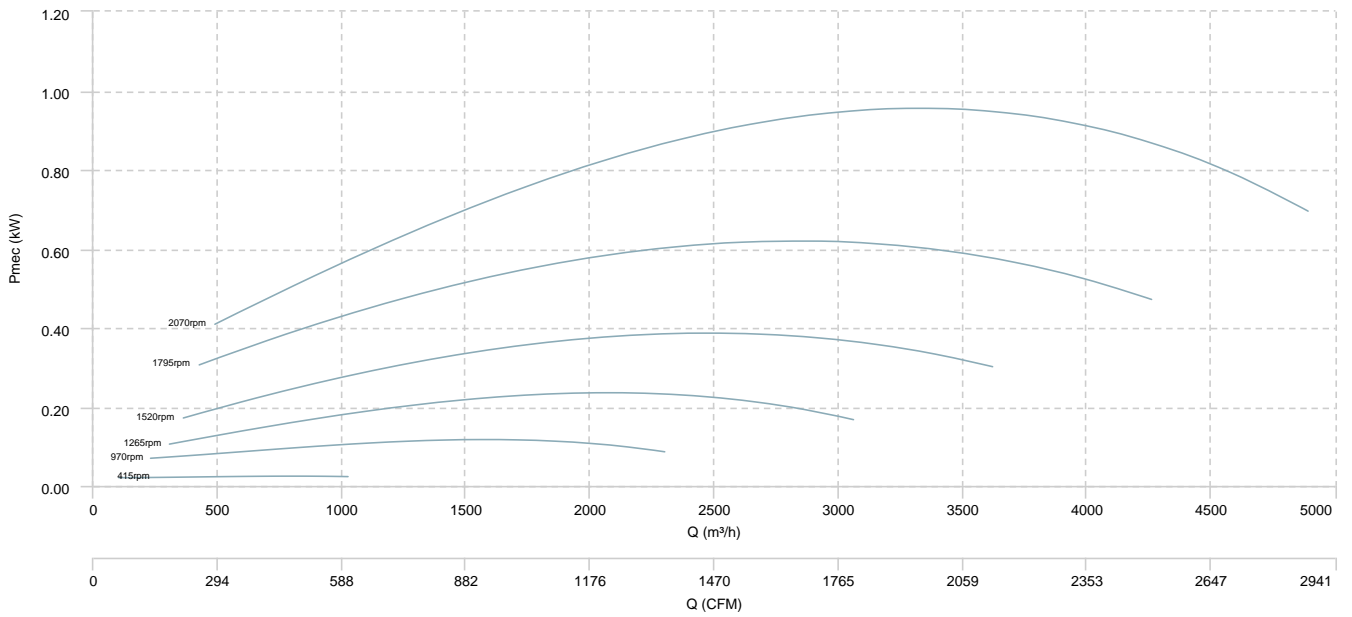

ENKELFAN 450 EEC

AIR FLOW - PRESSURE

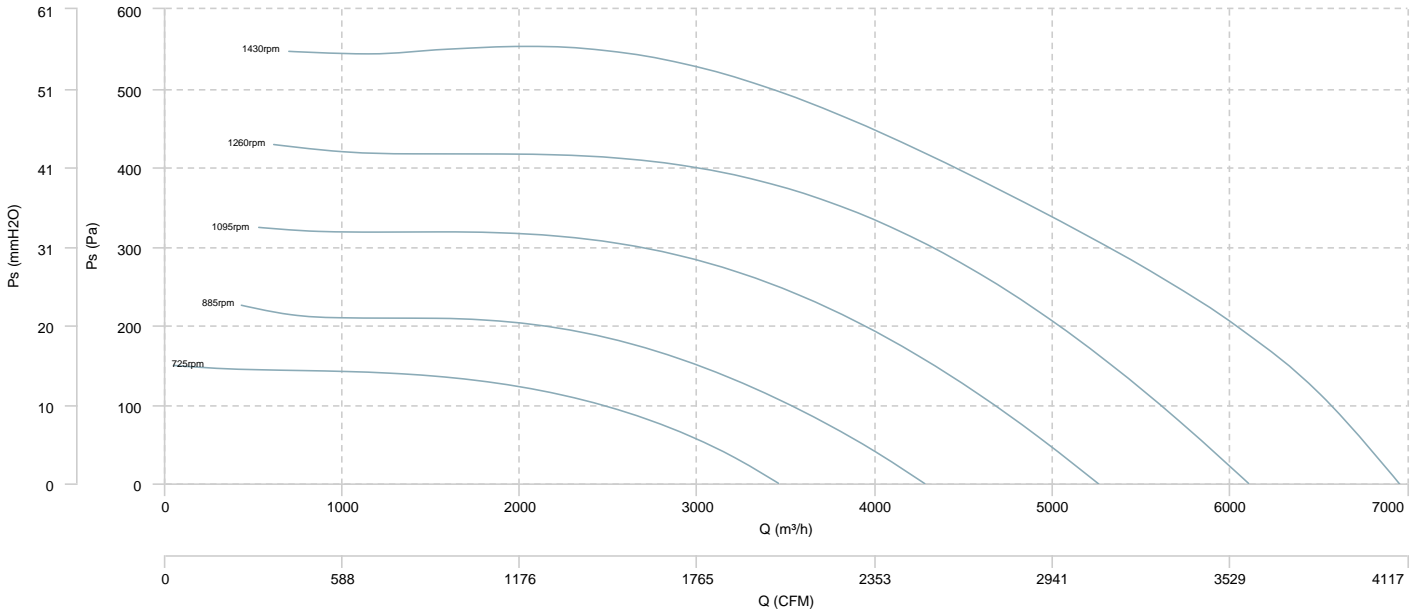

AIR FLOW - MECHANICAL POWER

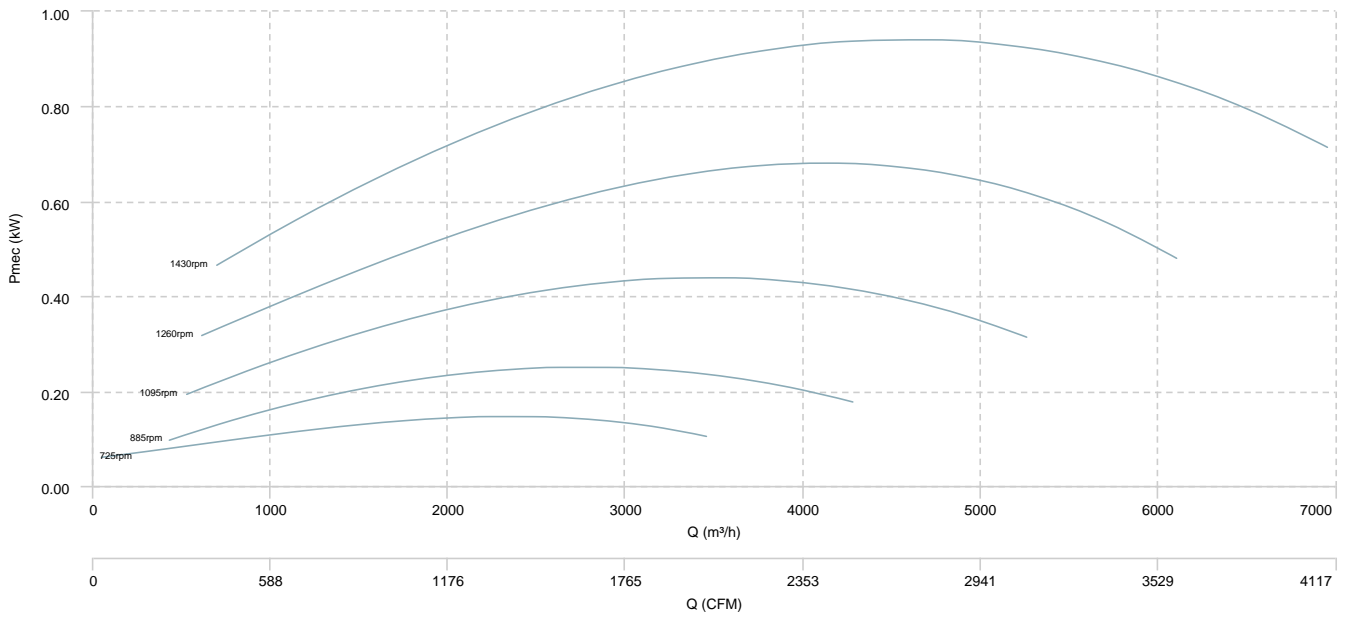

Sound data

Sound power Lw dB (A)										
Model		63 Hz	125 Hz	250 Hz	500 Hz	1000 Hz	2000 Hz	4000 Hz	8000 Hz	Total
ENKELFAN 155 EEC (2750rpm)	Radiated	32	22	39	51	56	61	51	44	63
ENKELFAN 190 EEC (1680rpm)	Radiated	8	15	30	43	51	54	47	39	57
ENKELFAN 250 EEC (1065rpm)	Radiated	5	19	43	50	53	52	44	30	57
ENKELFAN 310 EEC (1085rpm)	Radiated	14	33	49	59	60	55	47	39	64
ENKELFAN 355 EEC (415rpm)	Radiated	12	15	32	37	39	33	25	15	43
ENKELFAN 450 EEC (725rpm)	Radiated	23	39	43	53	55	48	38	30	58

Notes:

* To calculate the sound power level at different rpm from those indicated above, use the following formula:

$$Lw \text{ dB(A)}_{rpmA} = Lw \text{ dB(A)}_{rpmB} + 52.5 \cdot \log_{10} \frac{rpmA}{rpmB}$$

erp data

ERP	
Fan type	Centrifugal fan backward blades without casing
Installation category	A
Efficiency category	Static
The fan has to be installed with FSC	No

Model	Motor power (kW)	Maximum efficiency point data						
		Max. efficiency (%)	Efficiency grade (N) (N)	Air Flow (m³/h)	Ps (Pa)	Pabs (kW)	speed (rpm)	Specific ratio
ENKELFAN 250 EEC	0,15	50,65	68,44	899,90	395,53	0,20	8	1,00
ENKELFAN 250 EEC	0,15	50,99	68,35	942,22	411,26	0,22	10	1,00
ENKELFAN 310 EEC	0,36	50,53	68,12	1.241,40	303,72	0,21	6	1,00
ENKELFAN 310 EEC	0,36	51,65	66,81	1.624,71	392,49	0,36	7	1,00
ENKELFAN 310 EEC	0,36	52,28	65,96	1.872,80	465,14	0,50	8	1,00
ENKELFAN 310 EEC	0,36	52,68	66,46	1.865,27	455,50	0,49	10	1,00
ENKELFAN 355 EEC	0,99	50,18	67,34	1.827,44	228,40	0,23	5	1,00
ENKELFAN 355 EEC	0,99	52,89	67,80	2.132,52	334,91	0,38	6	1,00
ENKELFAN 355 EEC	0,99	54,54	67,27	2.504,34	470,08	0,61	7	1,00
ENKELFAN 355 EEC	0,99	55,54	66,37	2.934,37	618,50	0,93	8	1,01
ENKELFAN 355 EEC	0,99	55,01	65,78	2.937,14	617,82	0,94	10	1,01
ENKELFAN 450 EEC	1,01	49,76	69,11	2.026,11	121,15	0,14	4	1,00
ENKELFAN 450 EEC	1,01	52,67	69,49	2.654,56	174,68	0,25	5	1,00
ENKELFAN 450 EEC	1,01	56,07	70,35	3.164,80	271,70	0,44	6	1,00
ENKELFAN 450 EEC	1,01	56,32	68,65	3.603,46	366,47	0,67	7	1,00
ENKELFAN 450 EEC	1,01	56,10	66,82	4.024,81	458,51	0,95	8	1,00
ENKELFAN 450 EEC	1,01	55,34	66,17	4.043,84	442,58	0,93	10	1,00