

## HMX (F400+ATEX)



Long case axial fan 400°C/2h ATEX

**MANUFACTURING FEATURES:**

- Long case axial fan with reinforced body.
- Modular motor-impeller assembly. Cast aluminium impeller with variable pitch angle. Polyester powder finishing coat.
- Housing with motor access door.
- Standard asynchronous squirrel-cage motor with IP-55 protection and Class H insulation certified 400°C/2h and ATEX (II3G). Manufactured with standard voltages: 230/400V 50Hz in three phase motors up to 3kW and 400V 50Hz for higher powers and 2 speed motors. IE3 efficiency motor from 0,75kW up to 45kW in single speed

**APPLICATIONS:**

Designed for inline installation, they are suitable for:

- Smoke emergency exhaust with motor inside the hazardous area and high pressures needed.
- Maximum working temperature: 60°C.

**UNDER REQUEST:**

- Supply impeller (air direction from impeller to motor)
- 100% reversible impeller.

Official homologation by the European laboratory APPLUS according to EN 12101-3:2015  
 Certification Nr: 0370-CPR-0912

### Accessories



**AC**



**AVS**



**BA-400**



**BAD**



**INT  
400**



**JE 45**



**KIT HI**



**KIT TM**



**PO**



**PS**



**RP**



**SFC**



**SIL-C /  
SIL-CN**

## Technical data

### Three-phase motor / 4 poles

Code	Model	Angle	Min. Rated power kW	Max. Rated power kW	Max. Airflow m3/h	Sound db (A)**	Weight t*	Connect. diagram
-	HMFx 45 T4 (A5:6) F400	20° - 42,5°	0,75	0,75	6.170	51	19,90	1
-	HMFx 50 T4 (A5:6) F400	25° - 45°	0,75	0,75	9.180	55	26,20	1
-	HMFx 56 T4 (A5:6) F400	20° - 45°	0,75	1,50	14.480	70	31,90	1
-	HMFx 63 T4 (A5:6) F400	20° - 45°	0,75	2,20	20.110	74	36,90	1
-	HMFx 71 T4 (A5:6) F400	20° - 45°	0,75	3	27.220	79	43,60	1
-	HMFx 80 T4 (A5:6) F400	20° - 45°	2,20	4	37.370	76	50,20	1
-	HMFx 90 T4 (A3:4) F400	20° - 42°	3	15	48.110	73	81,60	1
-	HMFx 90 T4 (A3:8) F400	20° - 42°	3	15	54.810	78	86,70	1
-	HMFx 100 T4 (A3:4) F400	20° - 42°	5,50	22	67.210	72	101,70	1
-	HMFx 100 T4 (A3:8) F400	20° - 42°	5,50	22	77.810	81	107,30	1
-	HMFx 112 T4 (A3:4) F400	20° - 42°	7,50	37	92.110	76	125,10	1
-	HMFx 112 T4 (A3:8) F400	20° - 42°	7,50	37	104.010	83	131,20	1
-	HMFx 125 T4 (A3:4) F400	20° - 42°	11	45	124.010	83	140,30	1
-	HMFx 125 T4 (A3:8) F400	20° - 42°	11	45	141.010	89	146,90	1

### Three-phase motor / 6 poles

Code	Model	Angle	Min. Rated power kW	Max. Rated power kW	Max. Airflow m3/h	Sound db (A)**	Weight t*	Connect. diagram
-	HMFx 45 T6 (A5:6) F400	25° - 45°	0,75	0,75	4.060	42	19,90	1
-	HMFx 50 T6 (A5:6) F400	25° - 45°	0,75	0,75	5.950	46	26,20	1
-	HMFx 56 T6 (A5:6) F400	20° - 45°	0,75	0,75	9.660	67	31,90	1
-	HMFx 63 T6 (A5:6) F400	20° - 45°	0,75	0,75	13.410	71	36,90	1
-	HMFx 71 T6 (A5:6) F400	20° - 45°	0,75	0,75	18.150	76	43,60	1
-	HMFx 80 T6 (A5:6) F400	20° - 45°	0,75	2,20	24.910	72	50,20	1
-	HMFx 90 T6 (A3:4) F400	20° - 42°	1,50	5,50	31.210	63	81,60	1
-	HMFx 90 T6 (A3:8) F400	20° - 42°	1,50	5,50	35.510	68	86,70	1
-	HMFx 100 T6 (A3:4) F400	20° - 42°	1,50	7,50	43.610	63	101,70	1
-	HMFx 100 T6 (A3:8) F400	20° - 42°	1,50	7,50	50.410	71	107,30	1
-	HMFx 112 T6 (A3:4) F400	20° - 42°	2,20	11	59.710	66	125,10	1
-	HMFx 112 T6 (A3:8) F400	20° - 42°	2,20	11	67.610	73	131,20	1

Code	Model	Angle	Min. Rated power kW	Max. Rated power kW	Max. Airflow m <sup>3</sup> /h	Sound db (A)**	Weight t*	Connect. diagram
-	HMFx 125 T6 (A3:4) F400	20° - 42°	3	15	80.610	73	140,30	1
-	HMFx 125 T6 (A3:8) F400	20° - 42°	3	15	91.410	80	146,90	1

## 2 SPEED MOTOR / 4/6 poles

Code	Model	Angle	Min. Rated power kW	Max. Rated power kW	Max. Airflow m <sup>3</sup> /h	Sound db (A)**	Weight t*	Connect. diagram
-	HMFx 56 T4/T6 (A5:6) F400	20° - 45°	0,55	2,20	14.480	70	31,90	2
-	HMFx 63 T4/T6 (A5:6) F400	20° - 45°	0,55	2,20	20.110	74	36,90	2
-	HMFx 71 T4/T6 (A5:6) F400	20° - 45°	0,55	3	27.220	79	43,60	2
-	HMFx 80 T4/T6 (A5:6) F400	20° - 45°	1,10	4,50	37.370	76	50,20	2
-	HMFx 90 T4/T6 (A3:4) F400	20° - 42°	2,20	14	48.110	73	81,60	2
-	HMFx 90 T4/T6 (A3:8) F400	20° - 42°	2,20	14	54.810	78	86,70	2
-	HMFx 100 T4/T6 (A3:4) F400	20° - 42°	4,50	20	67.210	72	101,70	2
-	HMFx 100 T4/T6 (A3:8) F400	20° - 42°	4,50	20	75.110	81	107,30	2
-	HMFx 112 T4/T6 (A3:4) F400	20° - 42°	4,50	26	92.110	76	125,10	2
-	HMFx 112 T4/T6 (A3:8) F400	20° - 40°	4,50	26	91.810	83	131,20	2
-	HMFx 125 T4/T6 (A3:4) F400	20° - 42°	10	40	107.010	83	140,30	2
-	HMFx 125 T4/T6 (A3:8) F400	38° - 40°	10	40	97.910	89	146,90	2

## 2 SPEED MOTOR / 4/8 poles

Code	Model	Angle	Min. Rated power kW	Max. Rated power kW	Max. Airflow m <sup>3</sup> /h	Sound db (A)**	Weight t*	Connect. diagram
-	HMFx 45 T4/T8 (A5:6) F400	20° - 42,5°	0,60	1,60	6.170	51	19,90	1
-	HMFx 50 T4/T8 (A5:6) F400	25° - 45°	0,60	1,60	9.180	55	26,20	1
-	HMFx 56 T4/T8 (A5:6) F400	20° - 45°	0,60	2,80	14.480	70	31,90	3
-	HMFx 63 T4/T8 (A5:6) F400	20° - 45°	0,60	2,80	20.110	74	36,90	3
-	HMFx 71 T4/T8 (A5:6) F400	20° - 45°	0,60	4	27.220	79	43,60	3
-	HMFx 80 T4/T8 (A5:6) F400	20° - 45°	1,20	7,50	37.370	76	50,20	3
-	HMFx 90 T4/T8 (A3:4) F400	20° - 42°	2,80	17	48.110	73	81,60	3
-	HMFx 90 T4/T8 (A3:8) F400	20° - 42°	5,50	17	54.810	78	86,70	3
-	HMFx 100 T4/T8 (A3:4) F400	20° - 42°	5,50	20	67.210	72	101,70	3
-	HMFx 100 T4/T8 (A3:8) F400	20° - 42°	5,50	20	77.810	81	107,30	3
-	HMFx 112 T4/T8 (A3:4) F400	20° - 42°	5,50	37	92.110	76	125,10	3

Code	Model	Angle	Min. Rated power kW	Max. Rated power kW	Max. Airflow m <sup>3</sup> /h	Sound db (A)**	Weight t*	Connect. diagram
-	HMFx 112 T4/T8 (A3:8) F400	20° - 42°	5,50	37	104.010	83	131,20	3
-	HMFx 125 T4/T8 (A3:4) F400	20° - 42°	7,50	44	124.010	83	140,30	3
-	HMFx 125 T4/T8 (A3:8) F400	20° - 42°	7,50	44	141.010	89	146,90	3

**Notes:**

\* The motor is not included in fan weight

\*\* Total sound pressure level at the point of maximum flow measured in dB(A) in the suction measured in free field at a distance of 6m from the source

## Dimensions

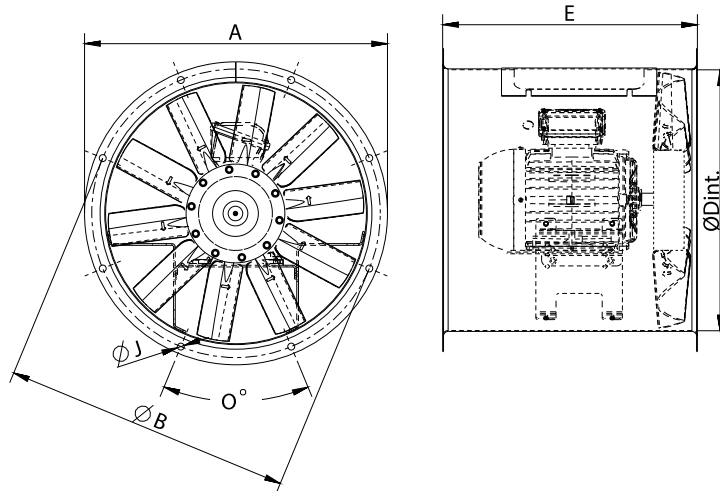

Model	E	O	ØA	ØB	ØD	ØJ
HMFx 45 T4 (A5:6) F400	455	8X45°	525	500	452	12
HMFx 45 T6 (A5:6) F400	455	8X45°	525	500	452	12
HMFx 45 T4/T8 (A5:6) F400	455	8X45°	525	500	452	12
HMFx 50 T4 (A5:6) F400	440	12x30°	600	560	504	12
HMFx 50 T6 (A5:6) F400	440	12x30°	600	560	504	12
HMFx 50 T4/T8 (A5:6) F400	440	12x30°	600	560	504	12
HMFx 56 T4 (A5:6) F400	560	12X30°	646	620	559	12
HMFx 56 T6 (A5:6) F400	560	12X30°	646	620	559	12
HMFx 56 T4/T6 (A5:6) F400	560	12X30°	646	620	559	12
HMFx 56 T4/T8 (A5:6) F400	560	12X30°	646	620	559	12
HMFx 63 T4 (A5:6) F400	550	12X30°	725	690	633	12
HMFx 63 T6 (A5:6) F400	550	12X30°	725	690	633	12
HMFx 63 T4/T6 (A5:6) F400	550	12X30°	725	690	633	12
HMFx 63 T4/T8 (A5:6) F400	550	12X30°	725	690	633	12
HMFx 71 T4 (A5:6) F400	600	16x22,5°	802	770	715	12
HMFx 71 T6 (A5:6) F400	600	16x22,5°	802	770	715	12
HMFx 71 T4/T6 (A5:6) F400	600	16x22,5°	802	770	715	12
HMFx 71 T4/T8 (A5:6) F400	600	16x22,5°	802	770	715	12
HMFx 80 T4 (A5:6) F400	600	16x22,5°	892	860	801	12
HMFx 80 T6 (A5:6) F400	600	16x22,5°	892	860	801	12
HMFx 80 T4/T6 (A5:6) F400	600	16x22,5°	892	860	801	12
HMFx 80 T4/T8 (A5:6) F400	600	16x22,5°	892	860	801	12
HMFx 90 T4 (A3:4) F400	820	16x22,5°	1000	970	903.5	12
HMFx 90 T4 (A3:8) F400	820	16x22,5°	1000	970	903.5	12
HMFx 90 T6 (A3:4) F400	820	16x22,5°	1000	970	903.5	12

Model	E	O	ØA	ØB	ØD	ØJ
HMFx 90 T6 (A3:8) F400	820	16x22,5º	1000	970	903.5	12
HMFx 90 T4/T6 (A3:4) F400	820	16x22,5º	1000	970	903.5	12
HMFx 90 T4/T6 (A3:8) F400	820	16x22,5º	1000	970	903.5	12
HMFx 90 T4/T8 (A3:4) F400	820	16x22,5º	1000	970	903.5	12
HMFx 90 T4/T8 (A3:8) F400	820	16x22,5º	1000	970	903.5	12
HMFx 100 T4 (A3:4) F400	820	16x22,5º	1115	1070	1013	12
HMFx 100 T4 (A3:8) F400	820	16x22,5º	1115	1070	1013	12
HMFx 100 T6 (A3:4) F400	820	16x22,5º	1115	1070	1013	12
HMFx 100 T6 (A3:8) F400	820	16x22,5º	1115	1070	1013	12
HMFx 100 T4/T6 (A3:4) F400	820	16x22,5º	1115	1070	1013	12
HMFx 100 T4/T6 (A3:8) F400	820	16x22,5º	1115	1070	1013	12
HMFx 100 T4/T8 (A3:4) F400	820	16x22,5º	1115	1070	1013	12
HMFx 100 T4/T8 (A3:8) F400	820	16x22,5º	1115	1070	1013	12
HMFx 112 T4 (A3:4) F400	1000	16x22,5º	1234	1190	1132	12
HMFx 112 T4 (A3:8) F400	1000	16x22,5º	1234	1190	1132	12
HMFx 112 T6 (A3:4) F400	1000	16x22,5º	1234	1190	1132	12
HMFx 112 T6 (A3:8) F400	1000	16x22,5º	1234	1190	1132	12
HMFx 112 T4/T6 (A3:4) F400	1000	16x22,5º	1234	1190	1132	12
HMFx 112 T4/T6 (A3:8) F400	1000	16x22,5º	1234	1190	1132	12
HMFx 112 T4/T8 (A3:4) F400	1000	16x22,5º	1234	1190	1132	12
HMFx 112 T4/T8 (A3:8) F400	1000	16x22,5º	1234	1190	1132	12
HMFx 125 T4 (A3:4) F400	1000	20x18º	1365	1320	1263	15
HMFx 125 T4 (A3:8) F400	1000	20x18º	1365	1320	1263	15
HMFx 125 T6 (A3:4) F400	1000	20x18º	1365	1320	1263	15
HMFx 125 T6 (A3:8) F400	1000	20x18º	1365	1320	1263	15
HMFx 125 T4/T6 (A3:4) F400	1000	20x18º	1365	1320	1263	15
HMFx 125 T4/T6 (A3:8) F400	1000	20x18º	1365	1320	1263	15
HMFx 125 T4/T8 (A3:4) F400	1000	20x18º	1365	1320	1263	15
HMFx 125 T4/T8 (A3:8) F400	1000	20x18º	1365	1320	1263	15

# Wiring diagram

DIAGRAM Nº 1

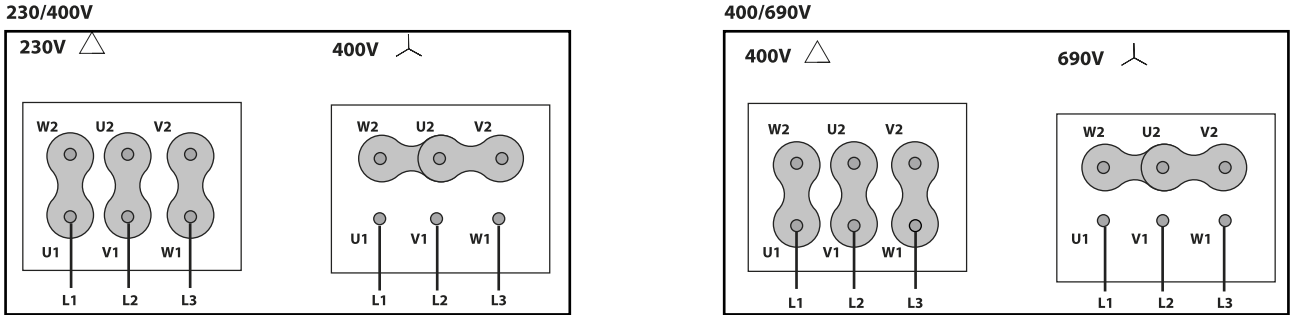

DIAGRAM Nº 2

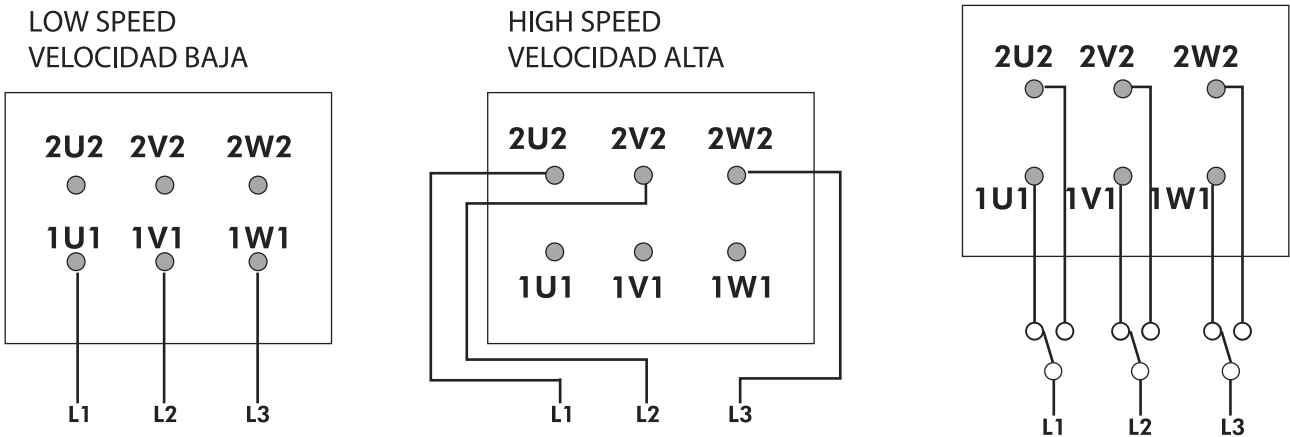
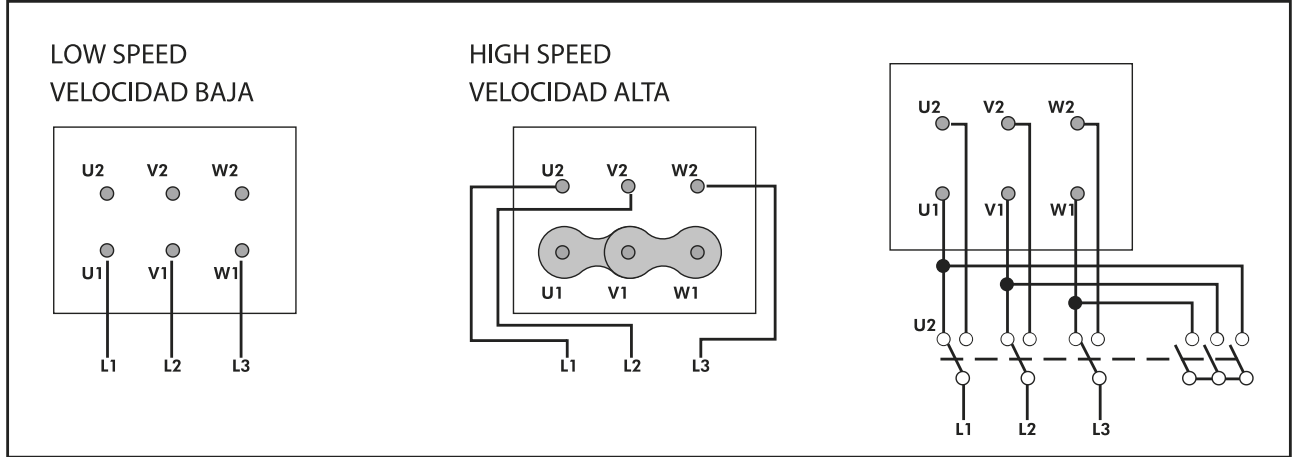

DIAGRAM Nº 3

400V DAHLANDER (Y,YY)





# CHARACTERISTIC CURVE

HMXF 45 T4 (A5:6) F400

## AIR FLOW - PRESSURE

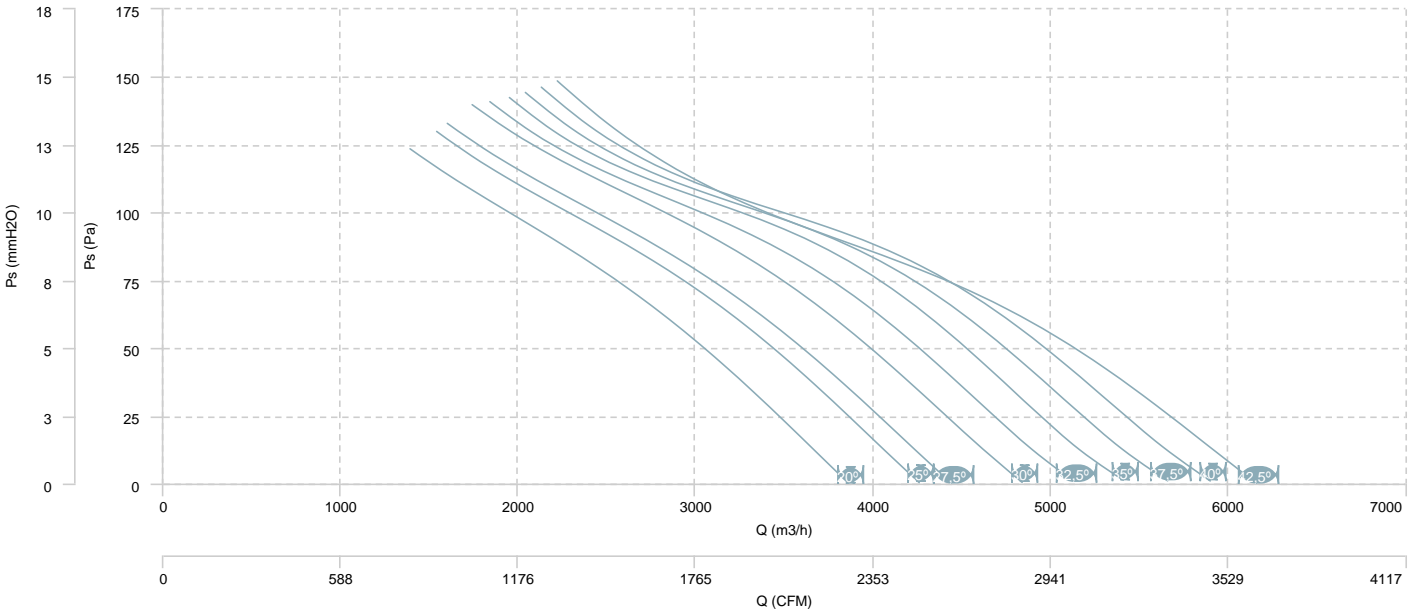

## AIR FLOW - MECHANICAL POWER

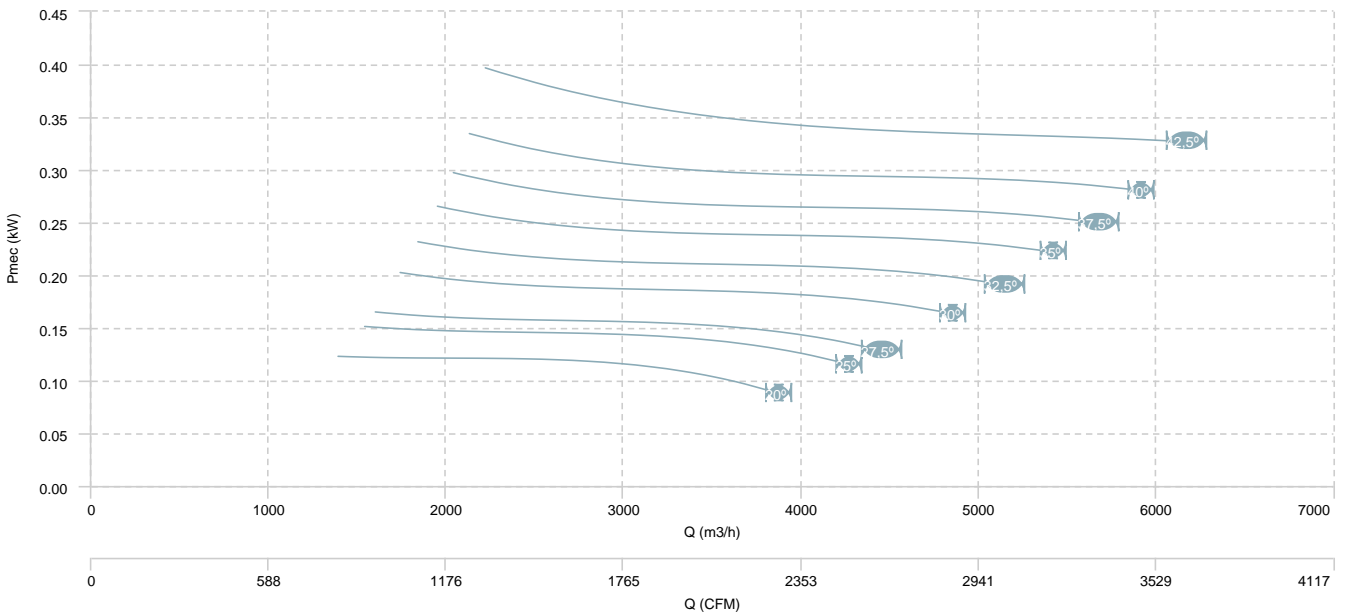

HMX 45 T6 (A5:6) F400

AIR FLOW - PRESSURE

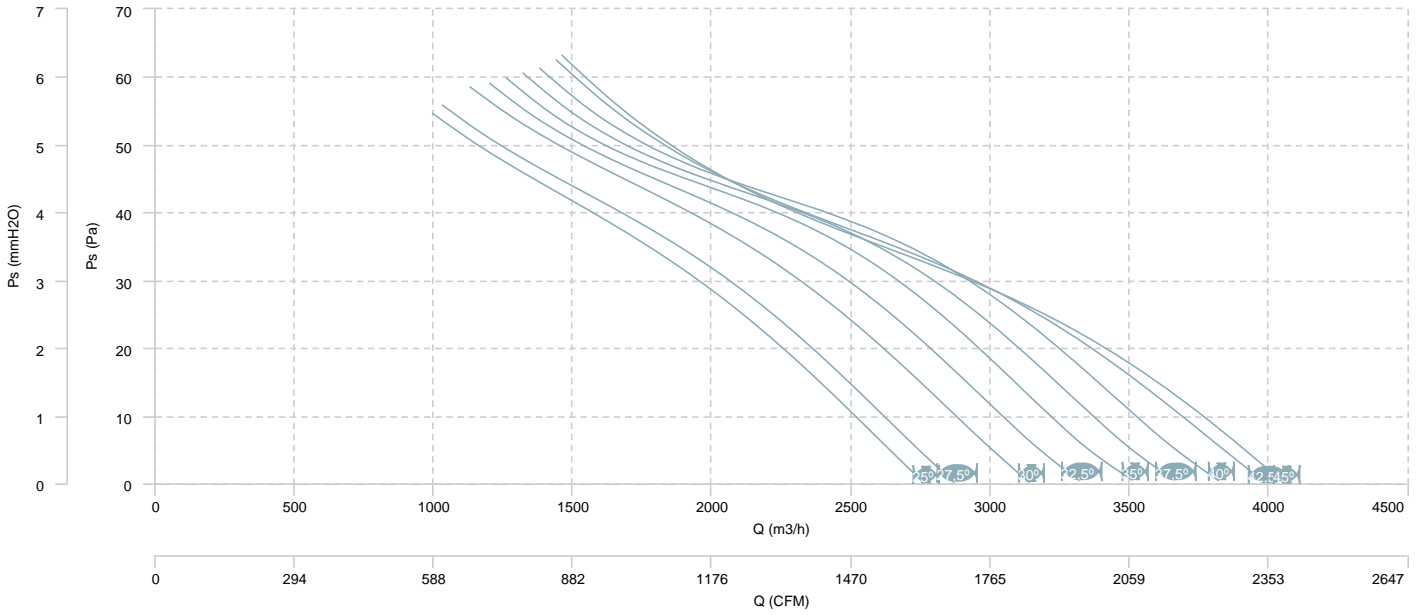

AIR FLOW - MECHANICAL POWER

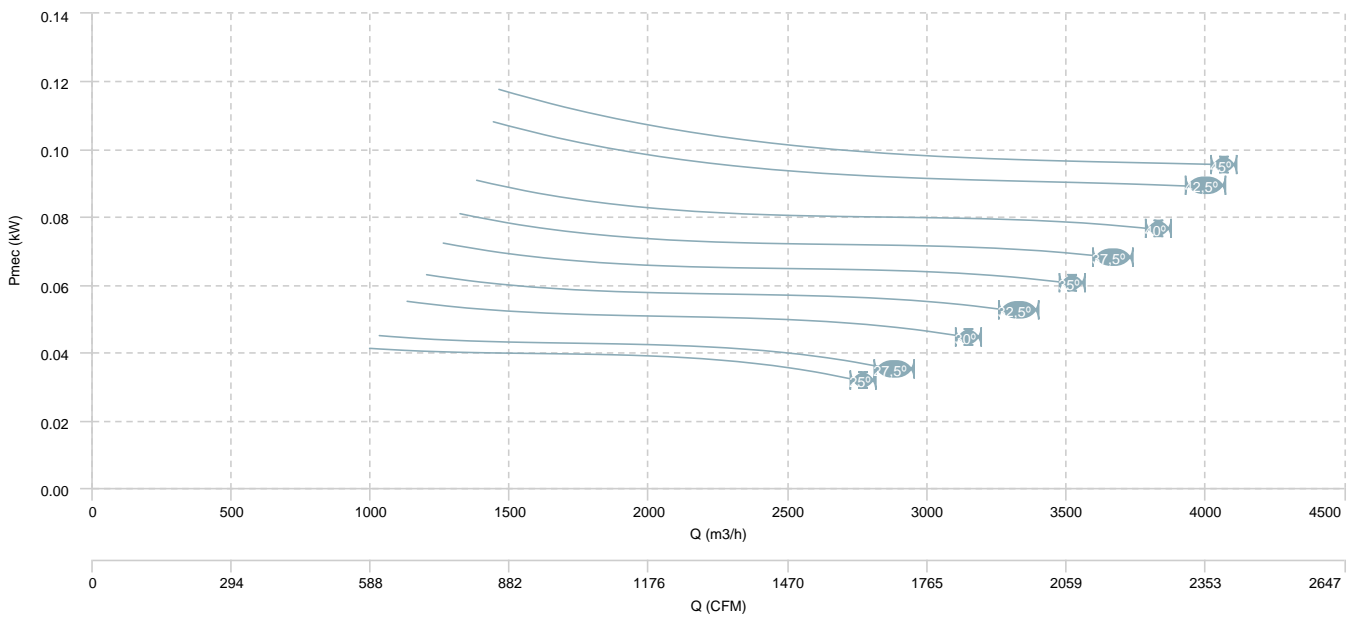

HMFx 45 T4/T8 (A5:6) F400

**AIR FLOW - PRESSURE (4 poles)**

HMFx 45 T4/T8 (A5:6) F400

**AIR FLOW - PRESSURE (8 poles)**

HMX5 50 T4 (A5:6) F400

AIR FLOW - PRESSURE

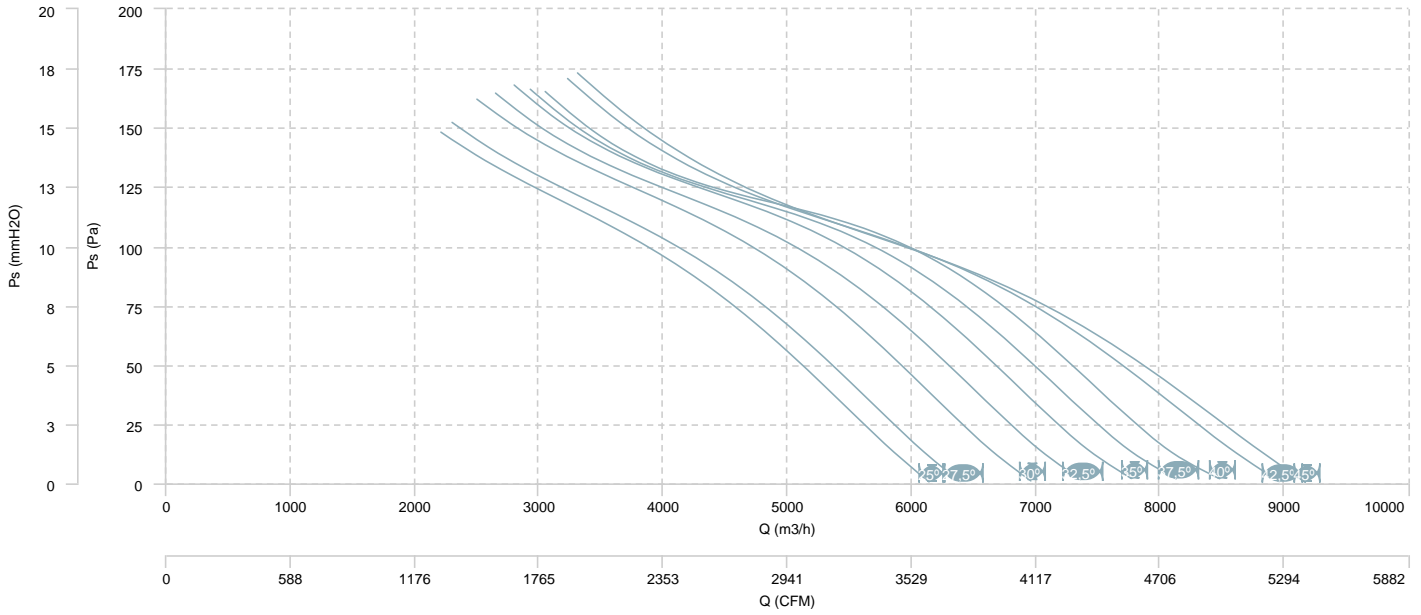

AIR FLOW - MECHANICAL POWER

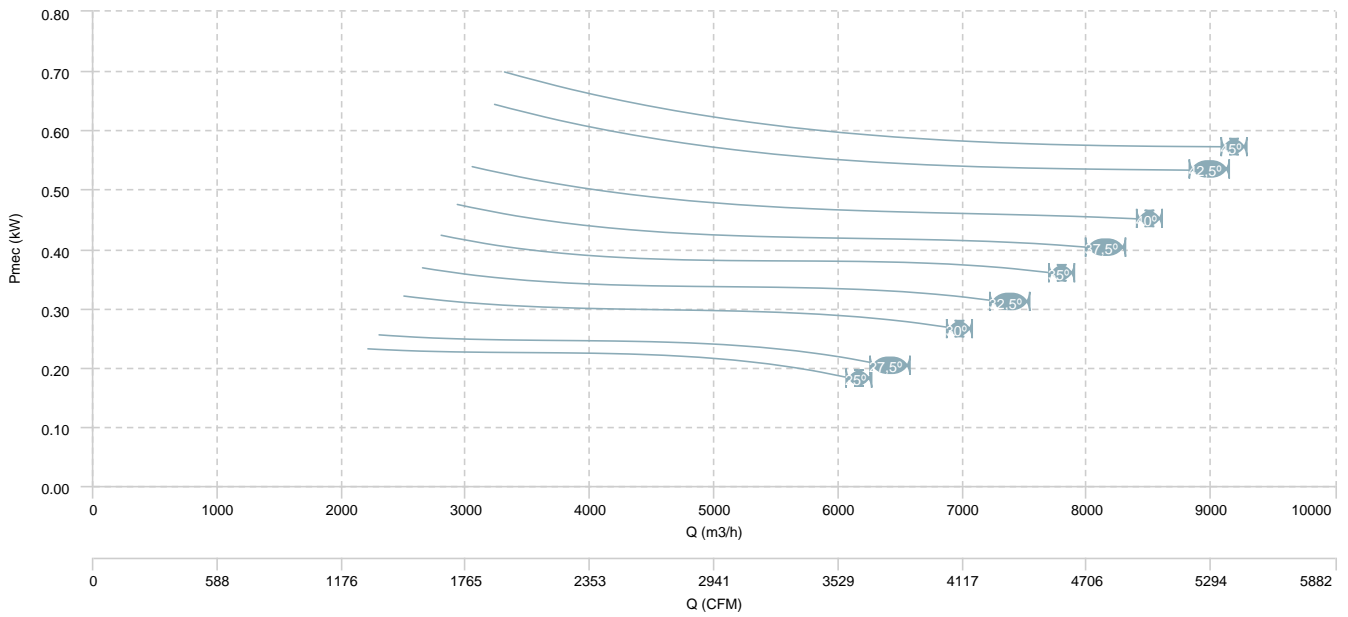

HMX50 T6 (A5:6) F400

AIR FLOW - PRESSURE

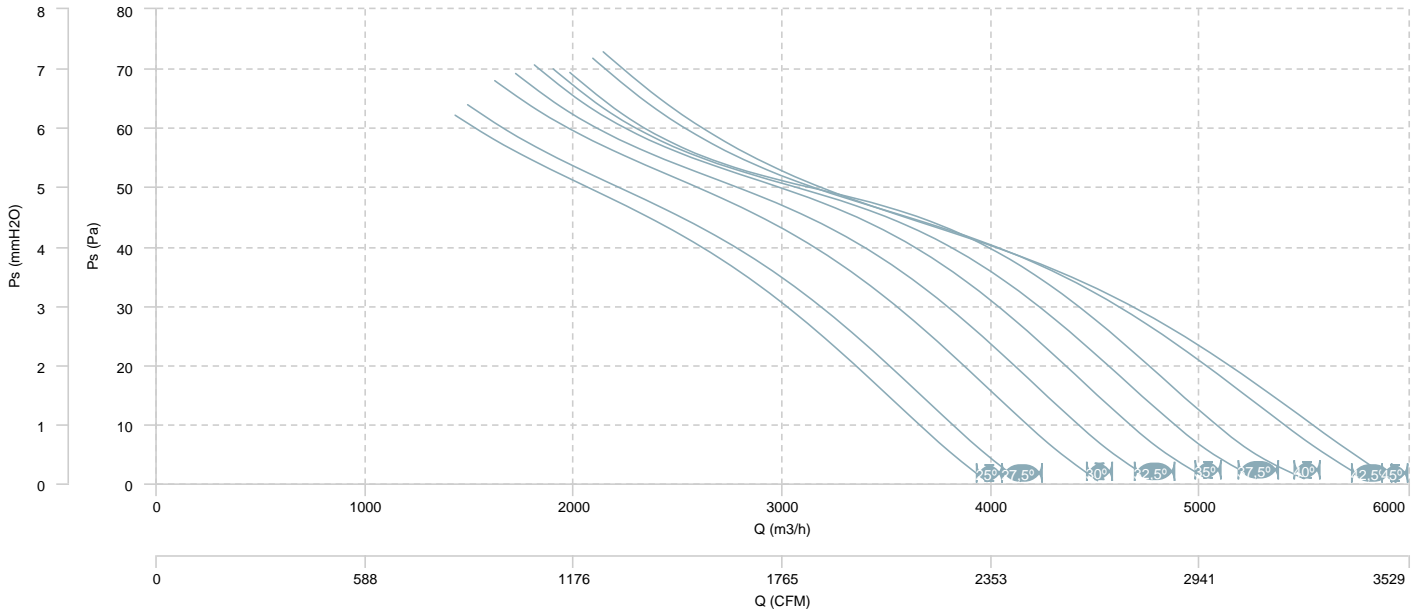

AIR FLOW - MECHANICAL POWER

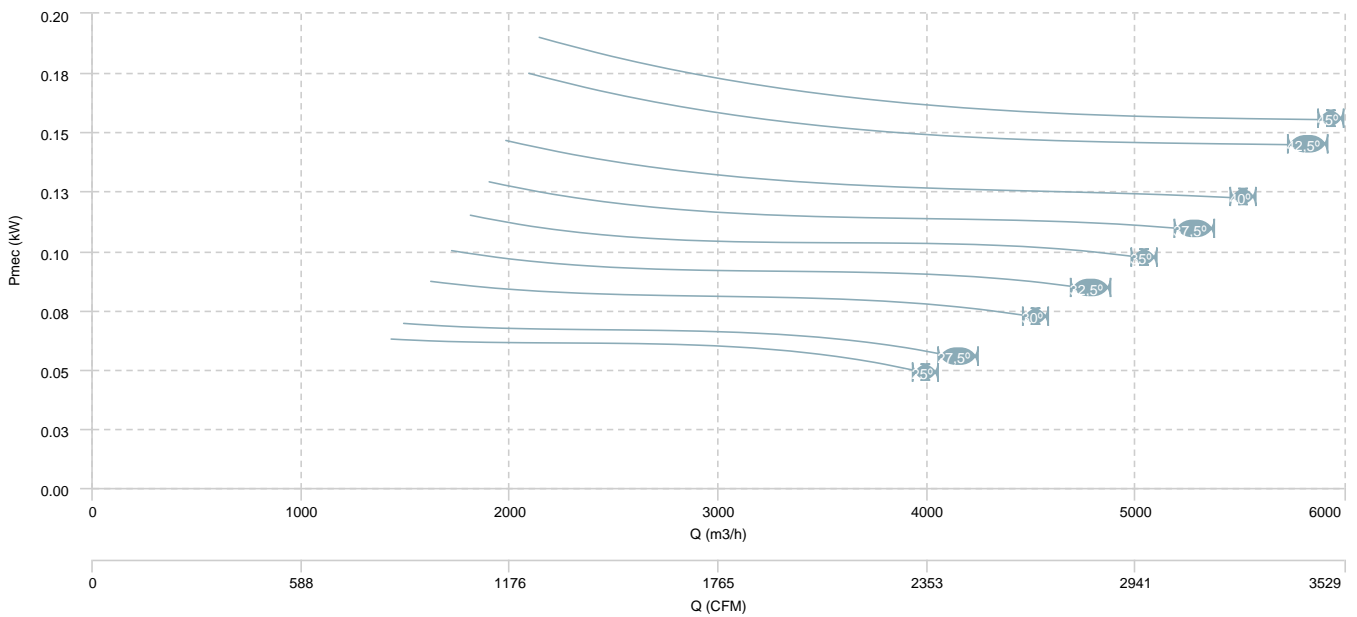

HMFx 50 T4/T8 (A5:6) F400

**AIR FLOW - PRESSURE (4 poles)**

HMFx 50 T4/T8 (A5:6) F400

**AIR FLOW - PRESSURE (8 poles)**



HMX5 56 T4 (A5:6) F400

AIR FLOW - PRESSURE

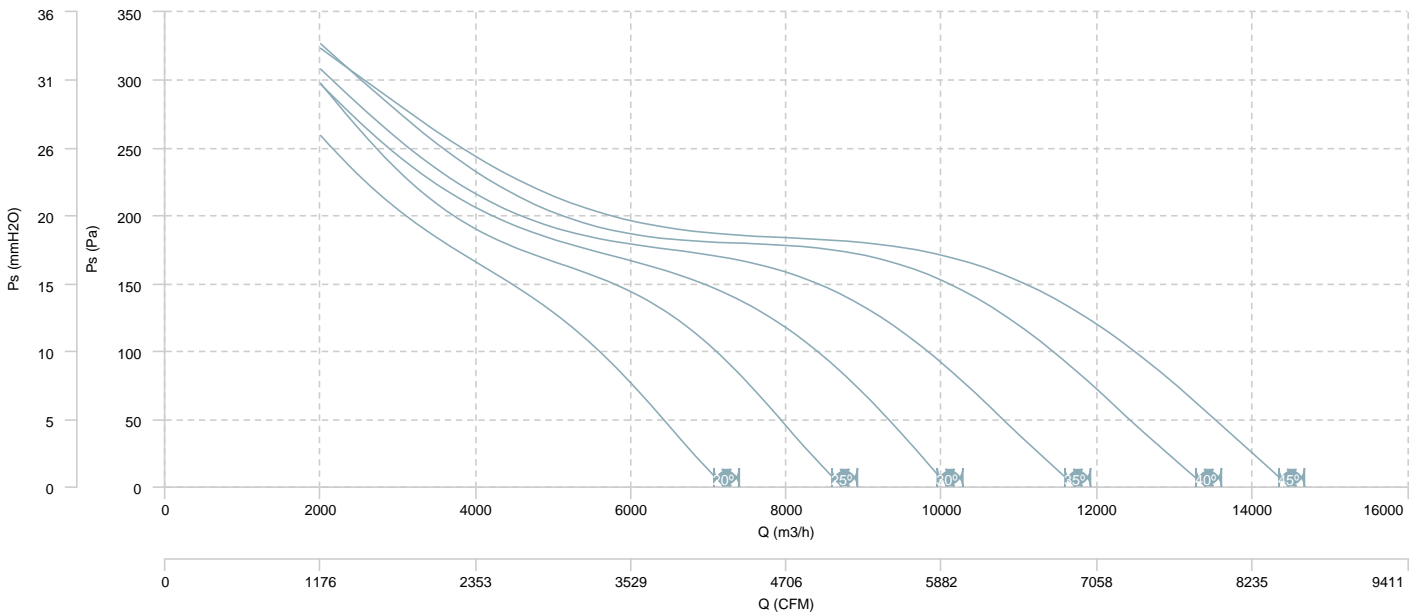

AIR FLOW - MECHANICAL POWER

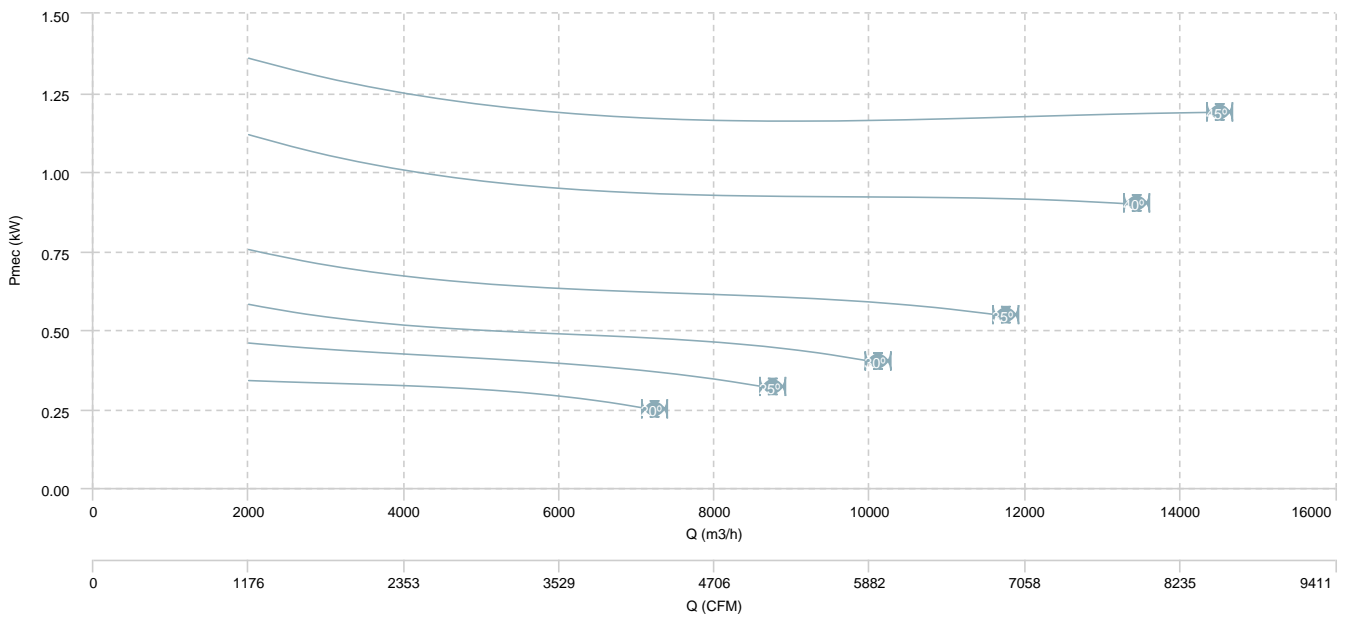

HMX5 56 T6 (A5:6) F400

AIR FLOW - PRESSURE

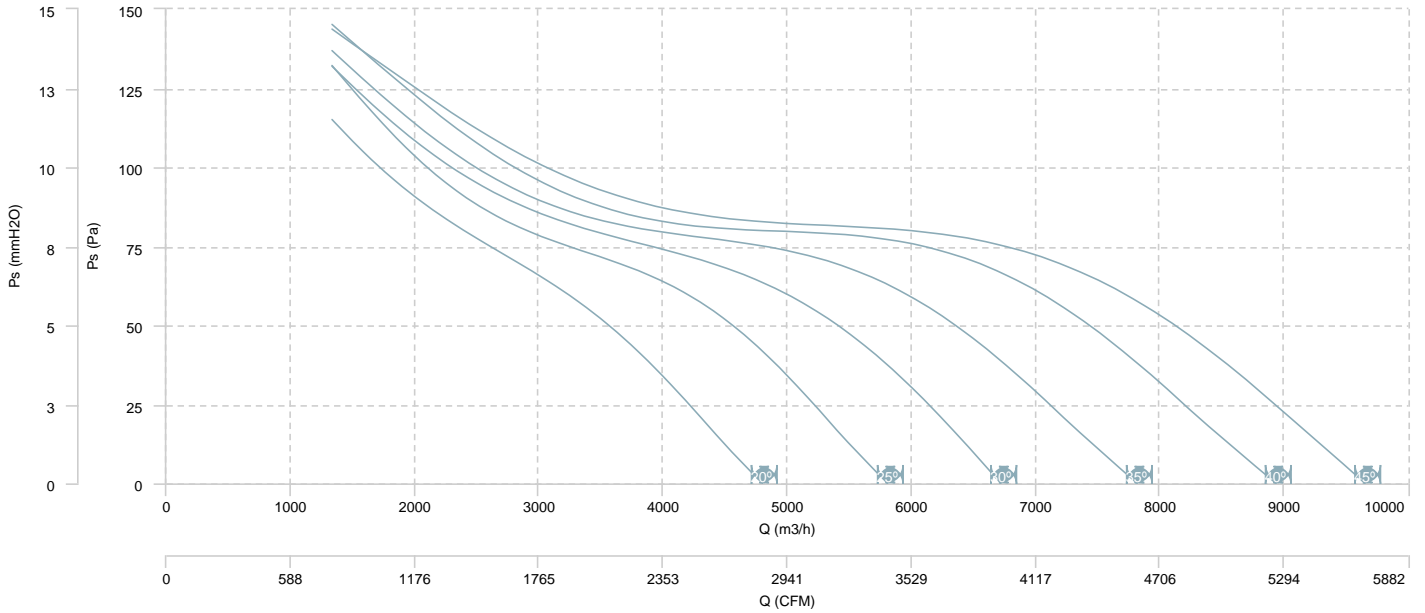

AIR FLOW - MECHANICAL POWER

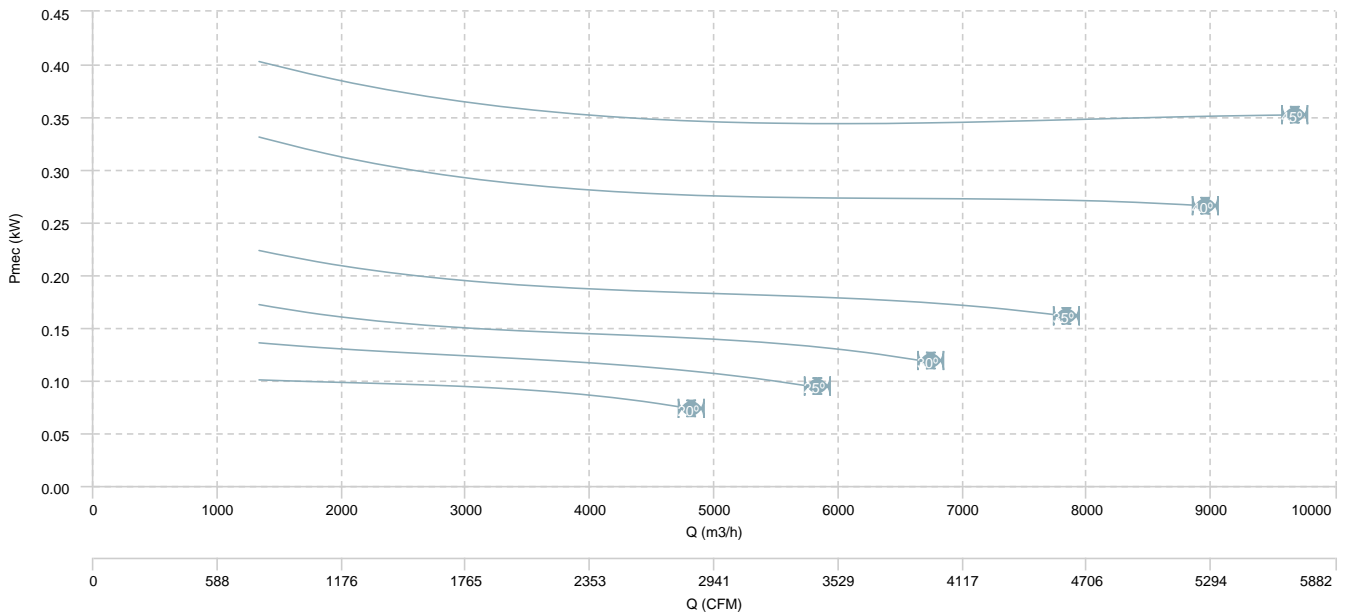

HMX5 56 T4/T6 (A5:6) F400

AIR FLOW - PRESSURE (4 poles)

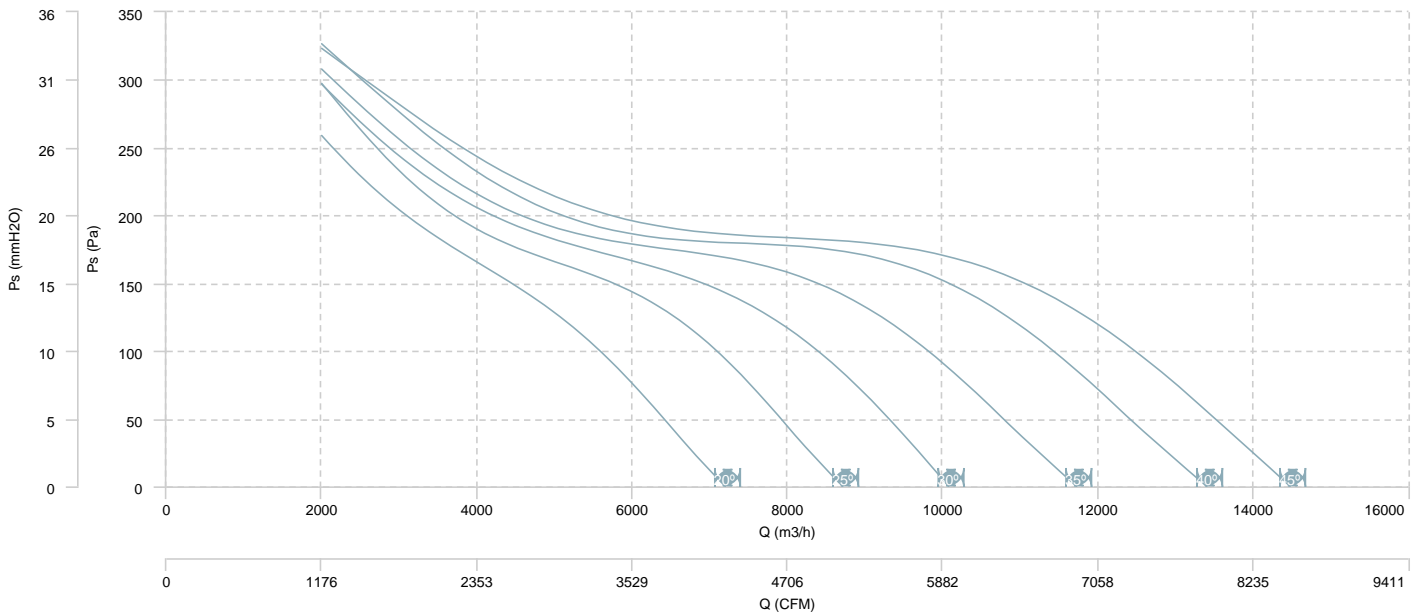

AIR FLOW - MECHANICAL POWER (4 poles)

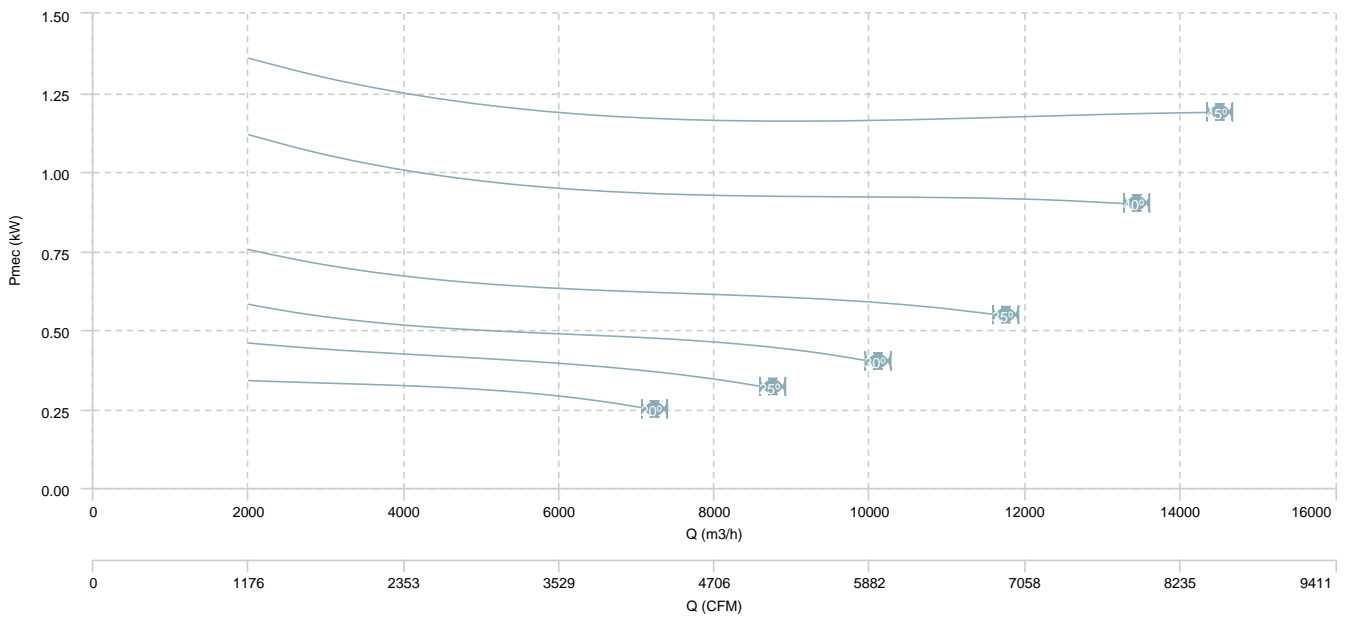

HMXF 56 T4/T6 (A5:6) F400

AIR FLOW - PRESSURE (6 poles)

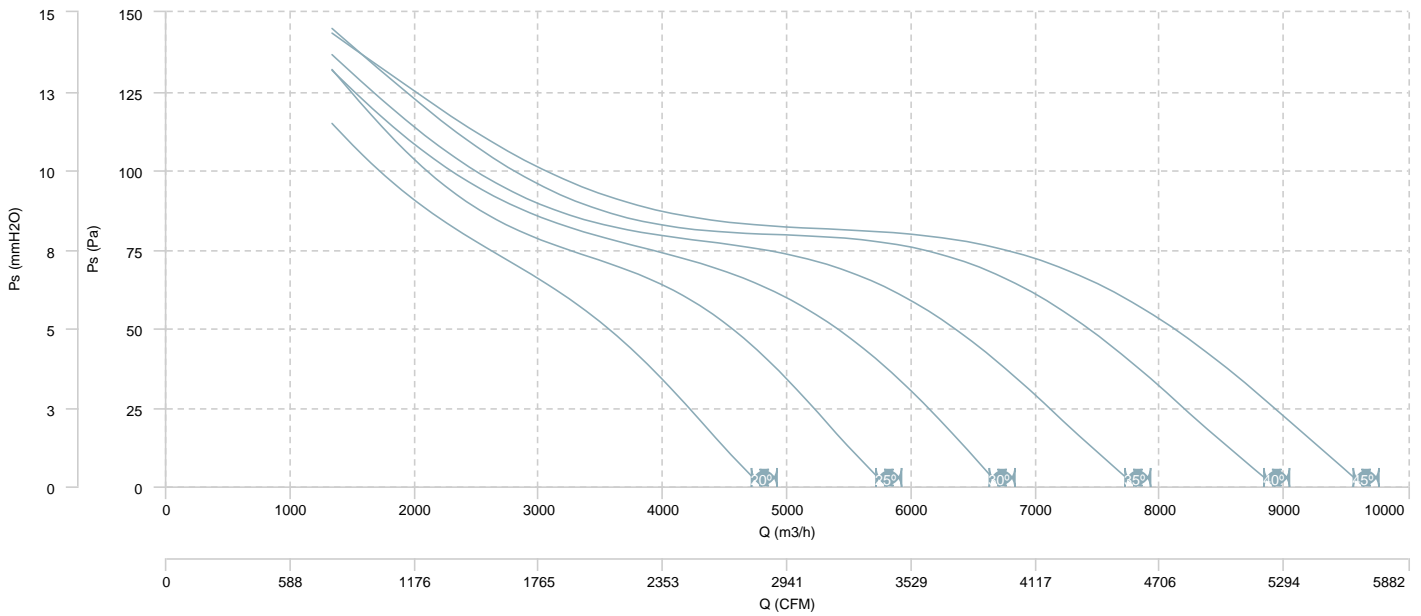

AIR FLOW - MECHANICAL POWER (6 poles)

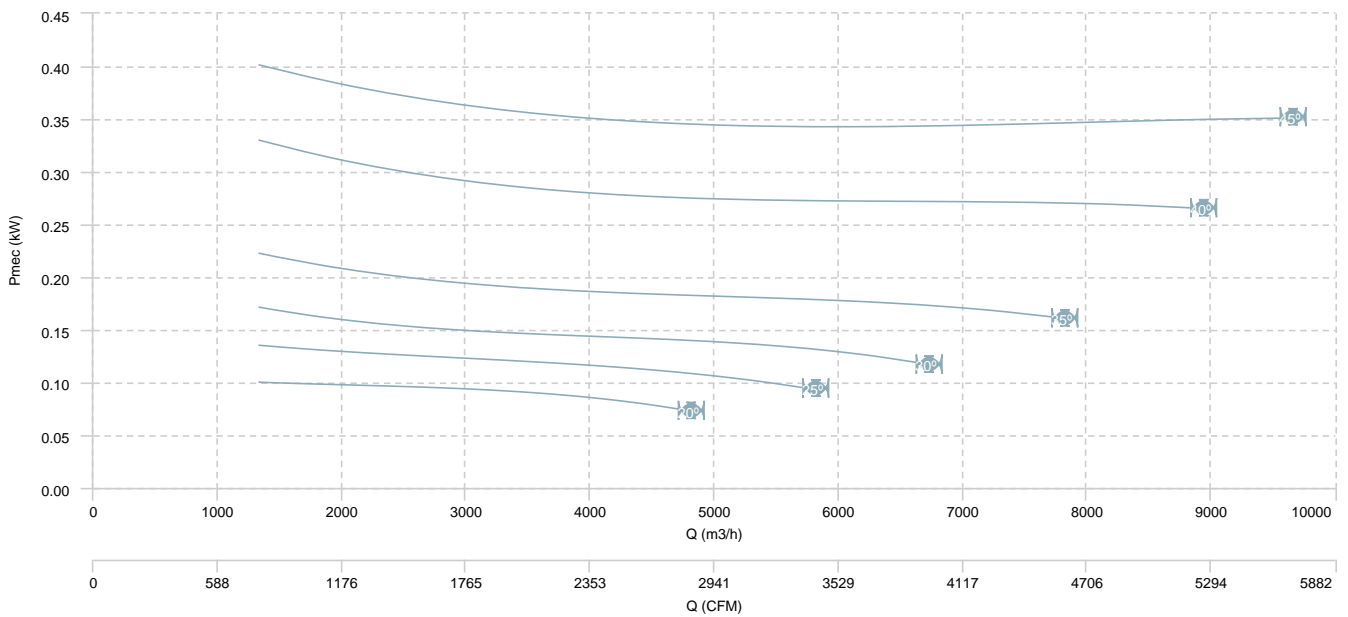

HMXF 56 T4/T8 (A5:6) F400

AIR FLOW - PRESSURE (4 poles)

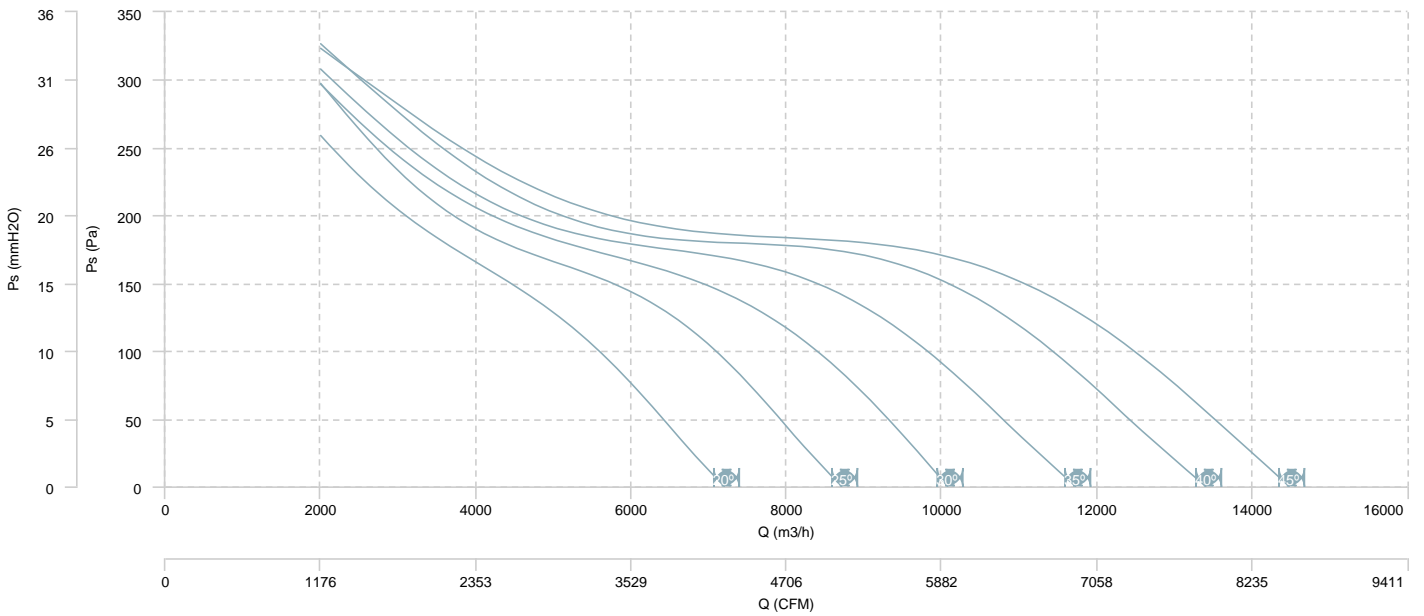

AIR FLOW - MECHANICAL POWER (4 poles)

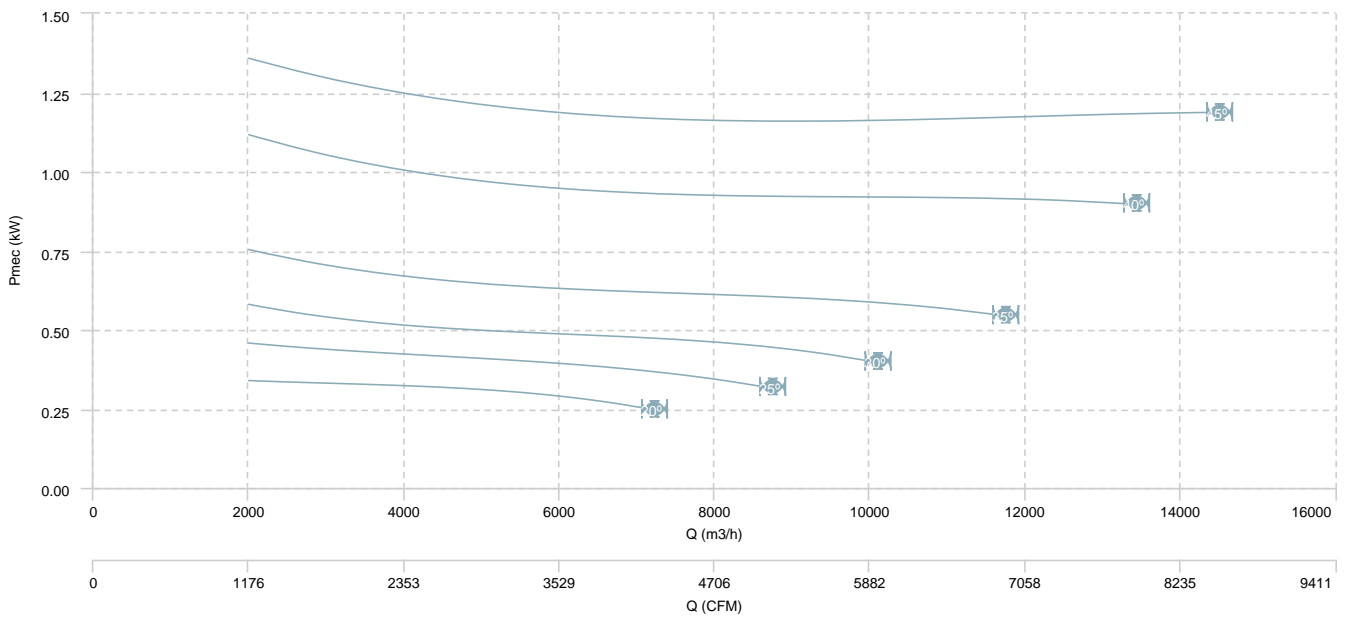

HMX5 56 T4/T8 (A5:6) F400

AIR FLOW - PRESSURE (8 poles)

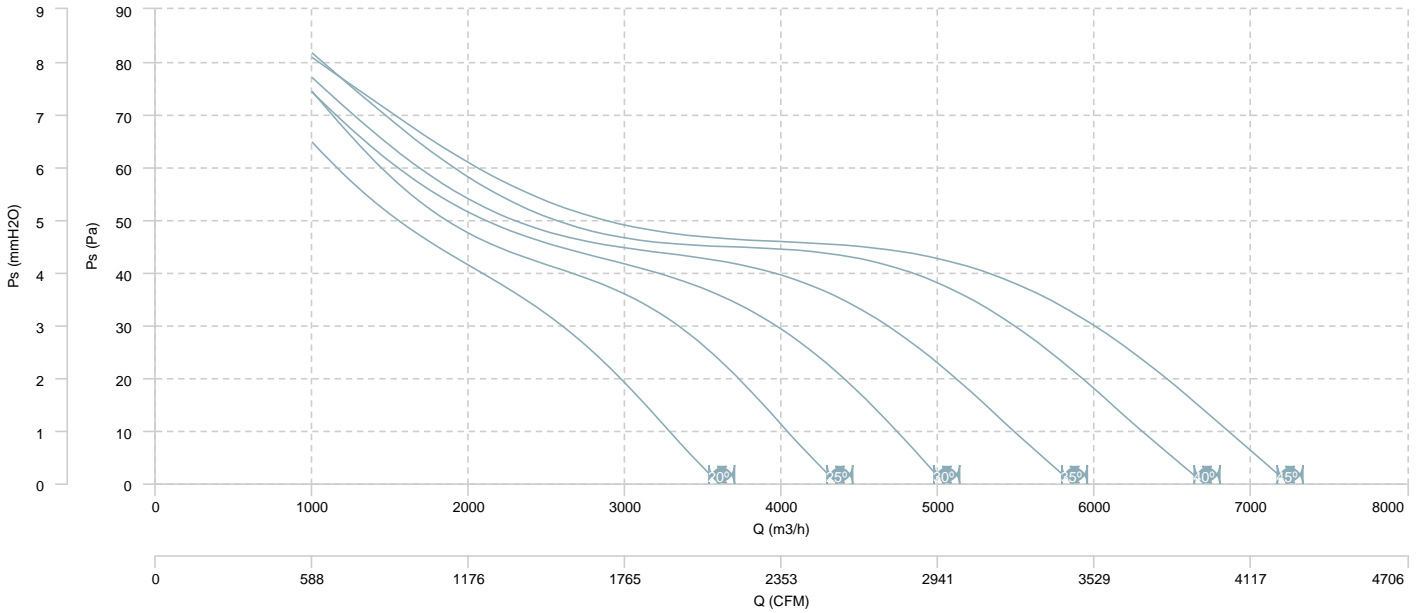

AIR FLOW - MECHANICAL POWER (8 poles)

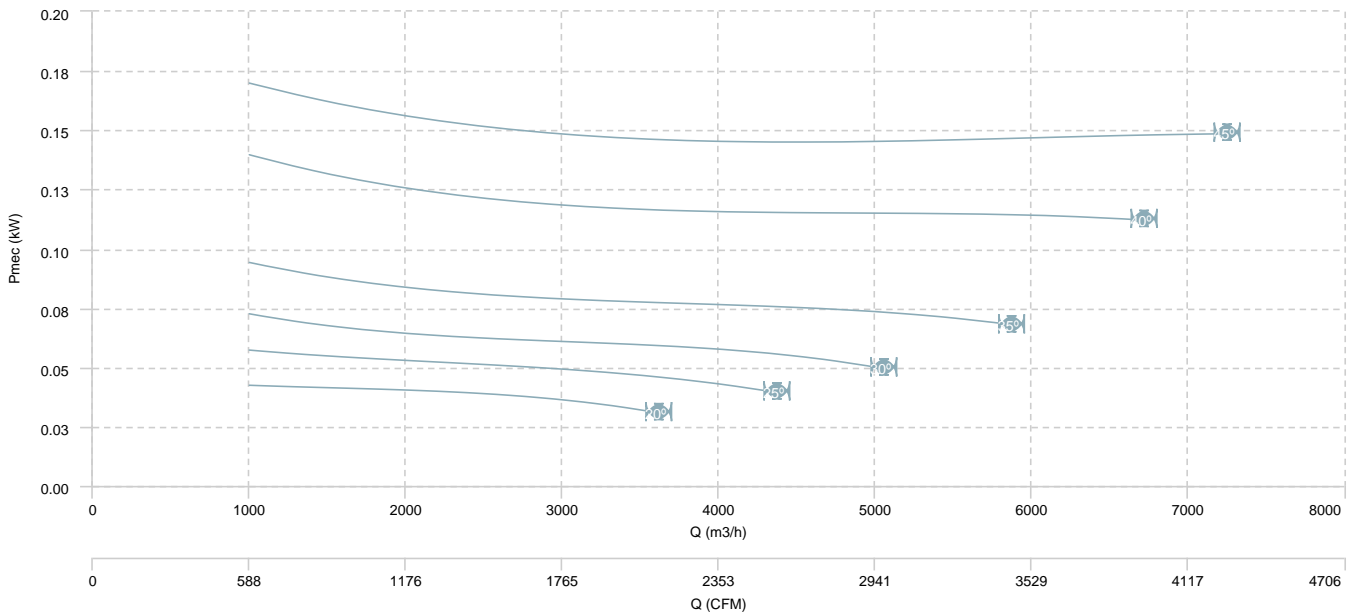

HMXF 63 T4 (A5:6) F400

AIR FLOW - PRESSURE

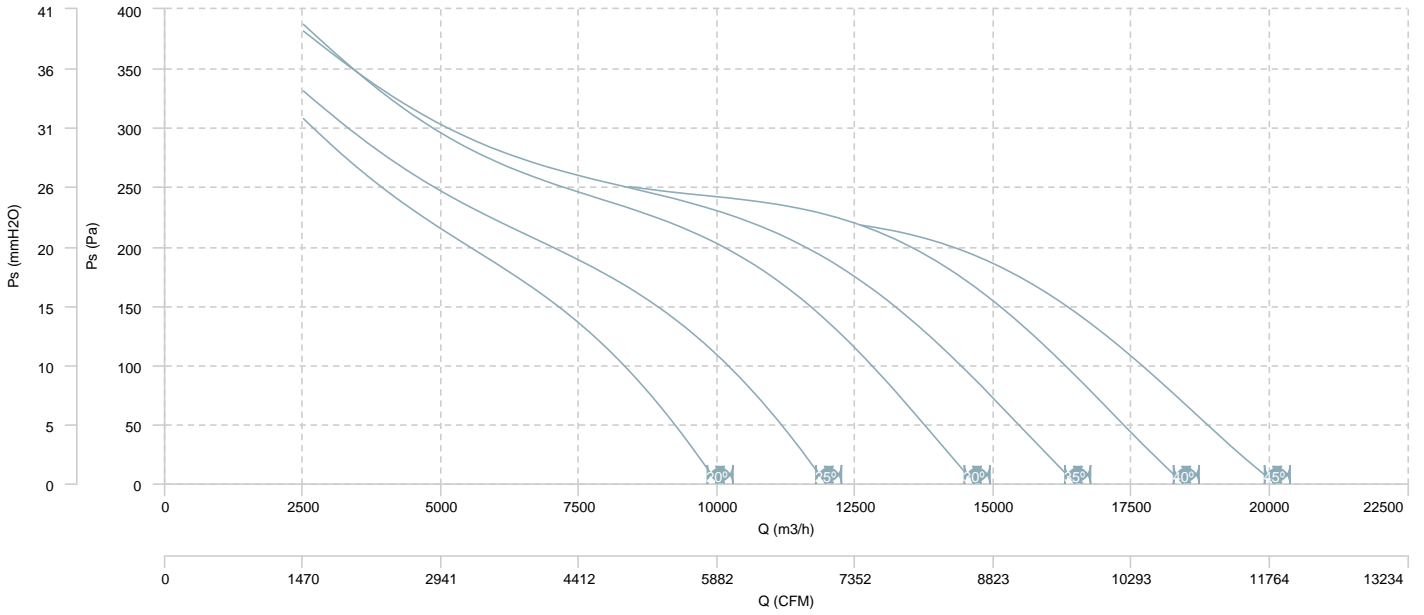

AIR FLOW - MECHANICAL POWER

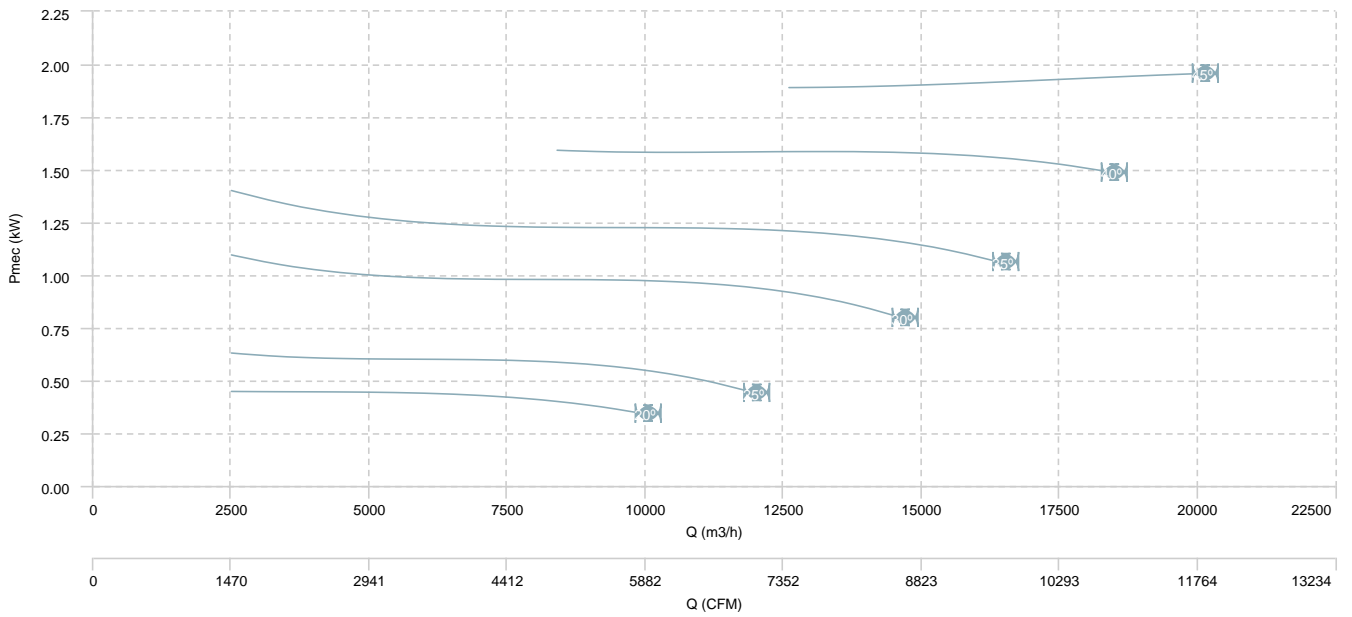

HMXF 63 T6 (A5:6) F400

AIR FLOW - PRESSURE

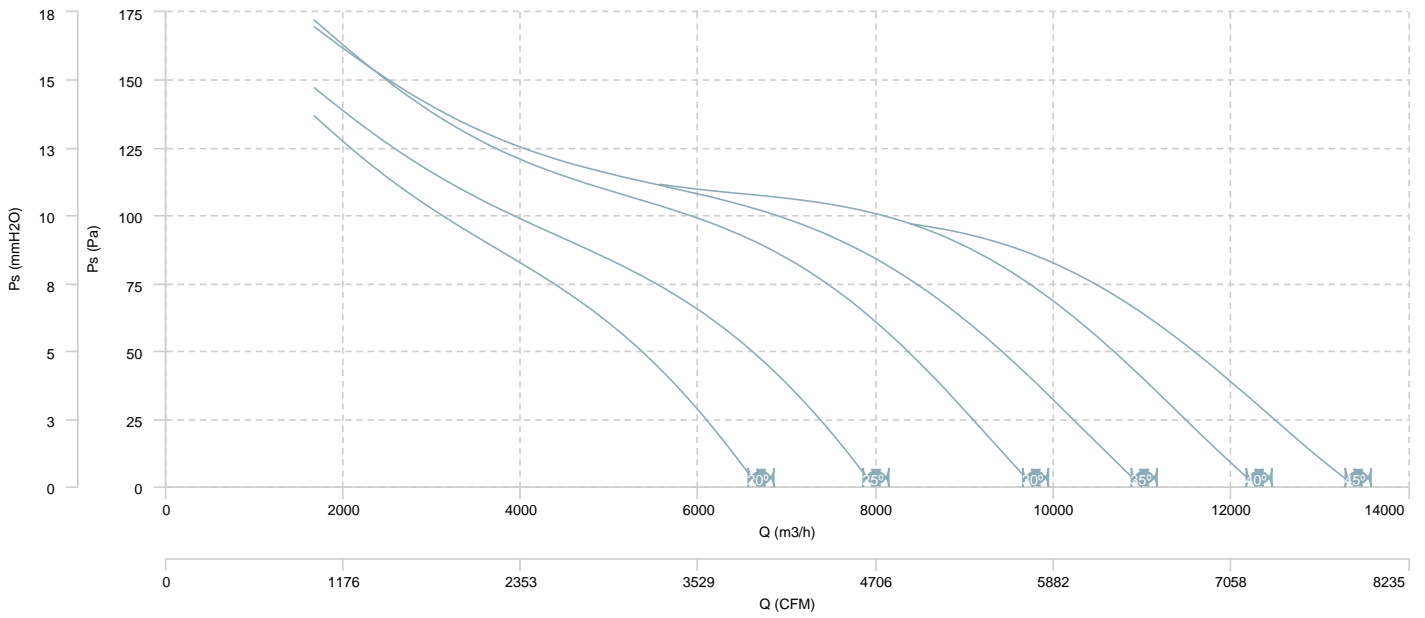

AIR FLOW - MECHANICAL POWER

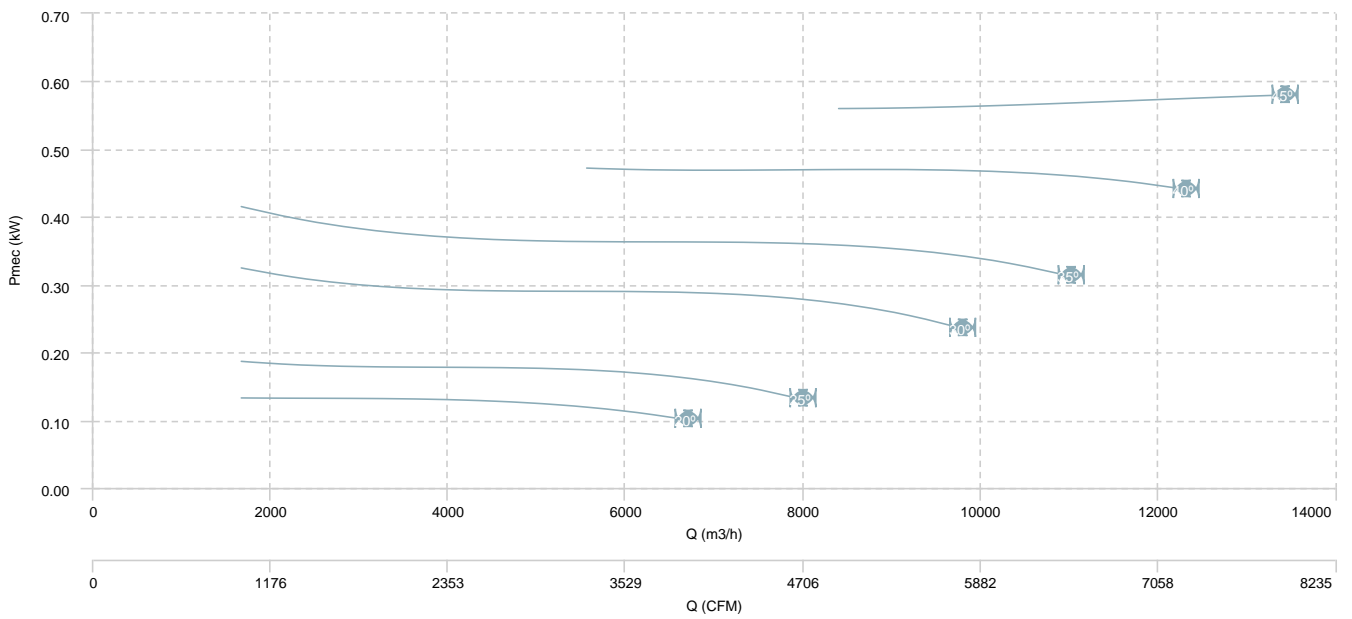



HMXF 63 T4/T6 (A5:6) F400

AIR FLOW - PRESSURE (4 poles)

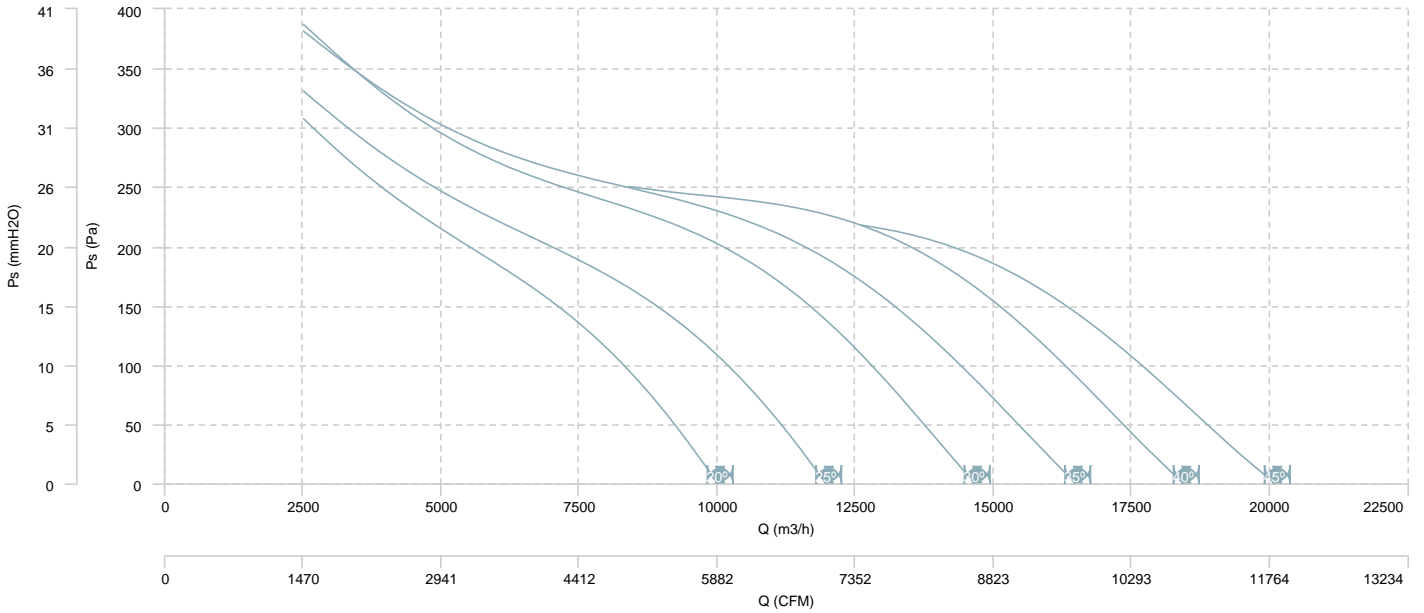

AIR FLOW - MECHANICAL POWER (4 poles)

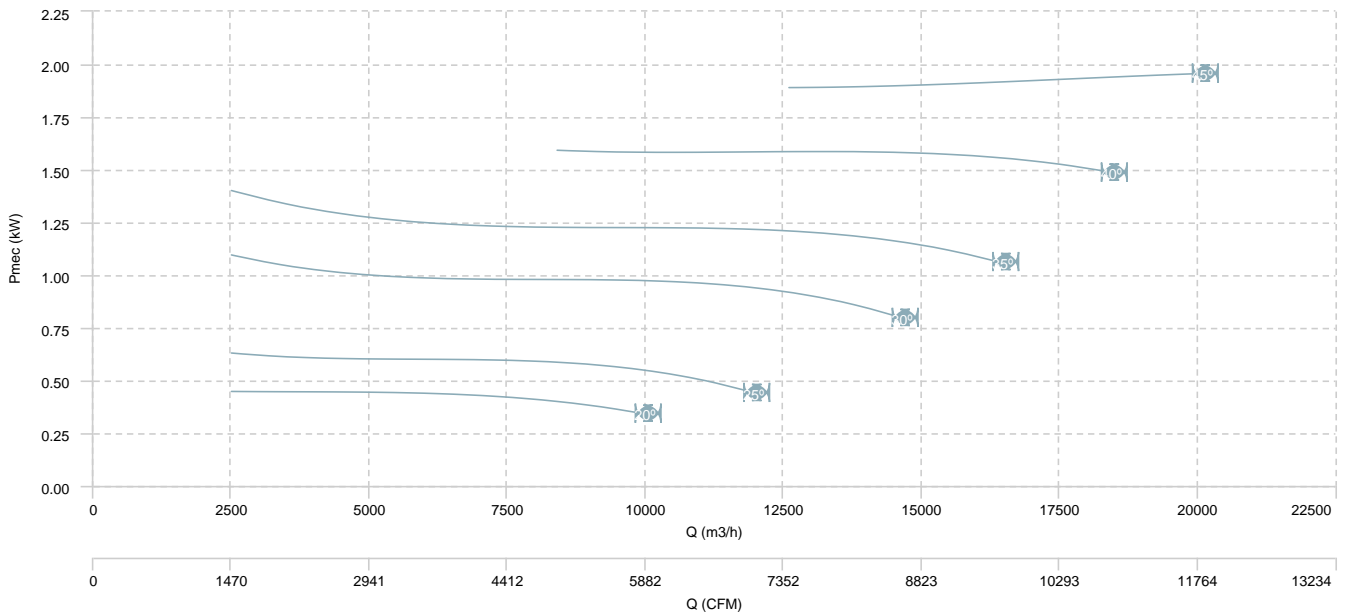

HMXF 63 T4/T6 (A5:6) F400

AIR FLOW - PRESSURE (6 poles)

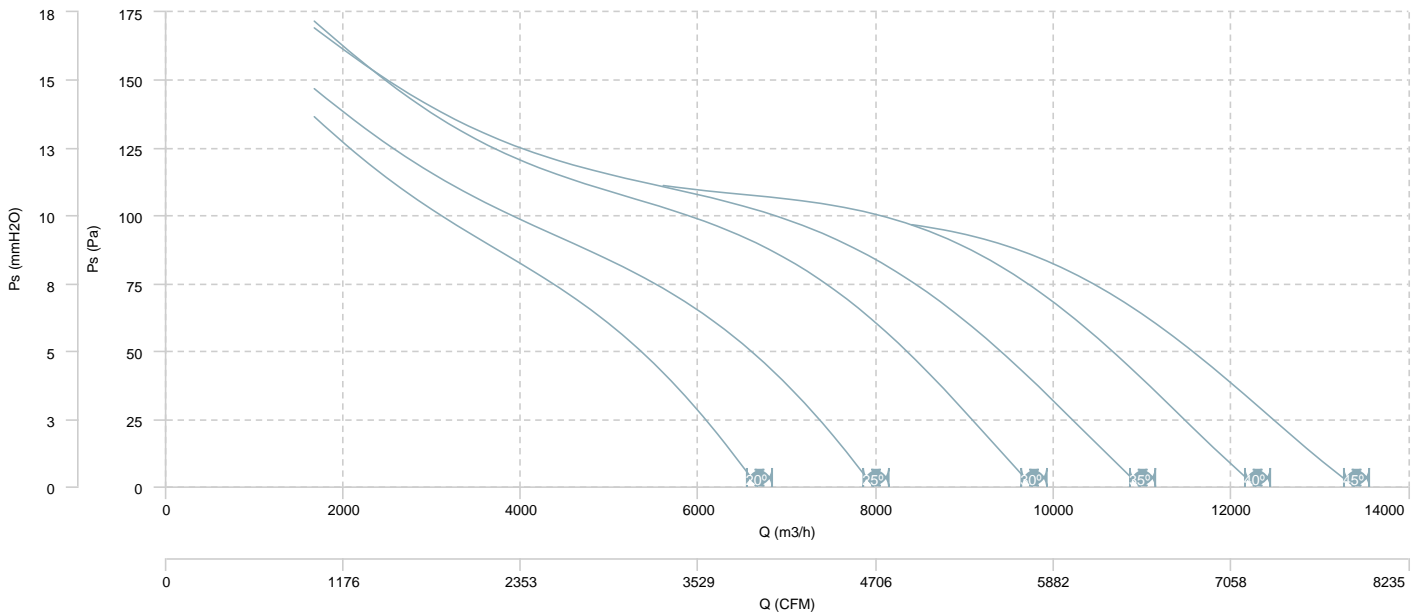

AIR FLOW - MECHANICAL POWER (6 poles)

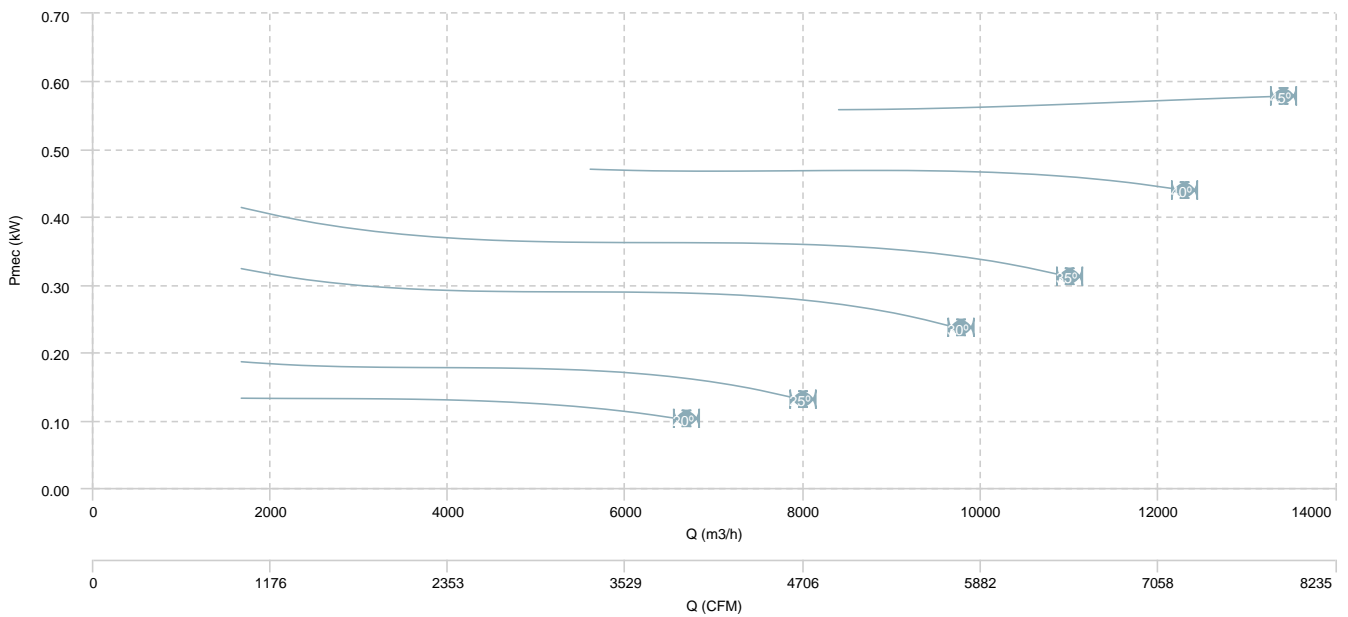

HMXF 63 T4/T8 (A5:6) F400

AIR FLOW - PRESSURE (4 poles)

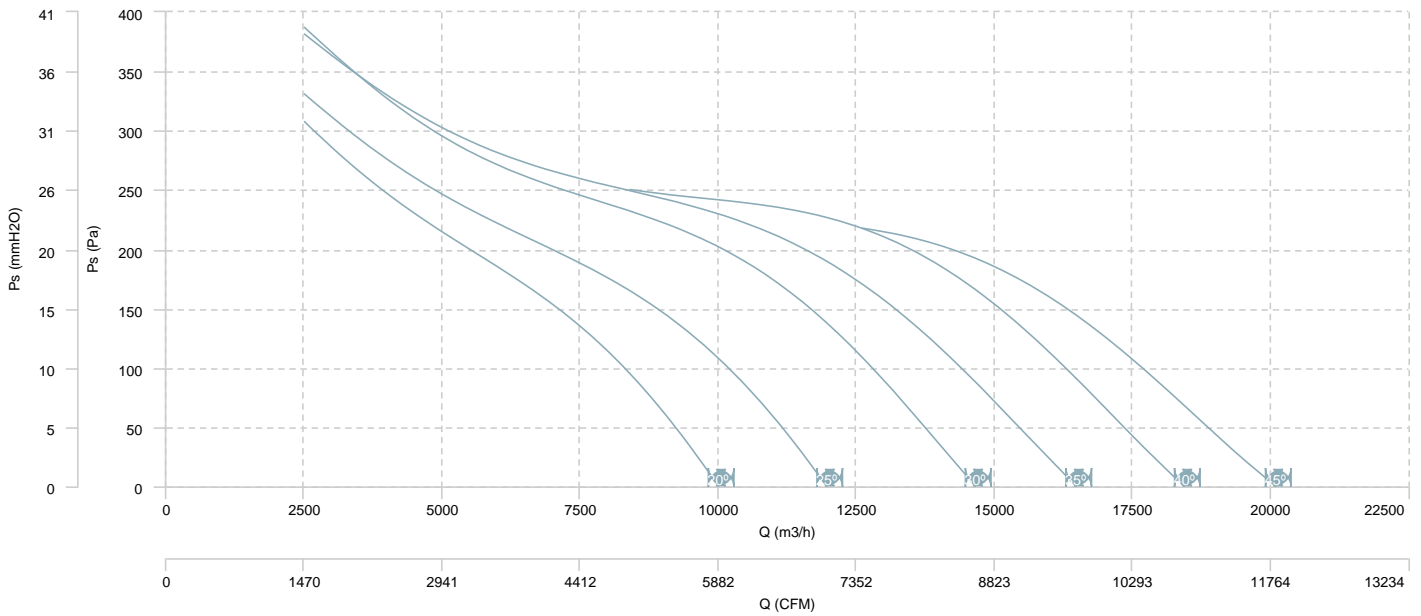

AIR FLOW - MECHANICAL POWER (4 poles)

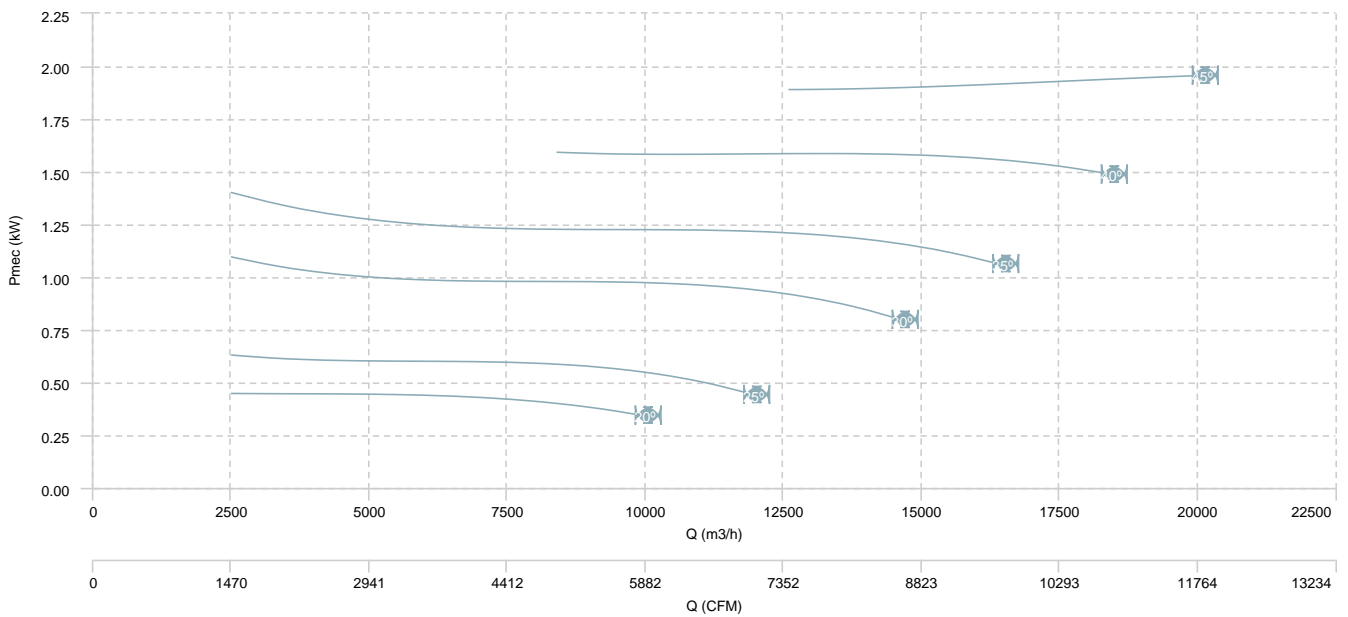

HMXF 63 T4/T8 (A5:6) F400

AIR FLOW - PRESSURE (8 poles)

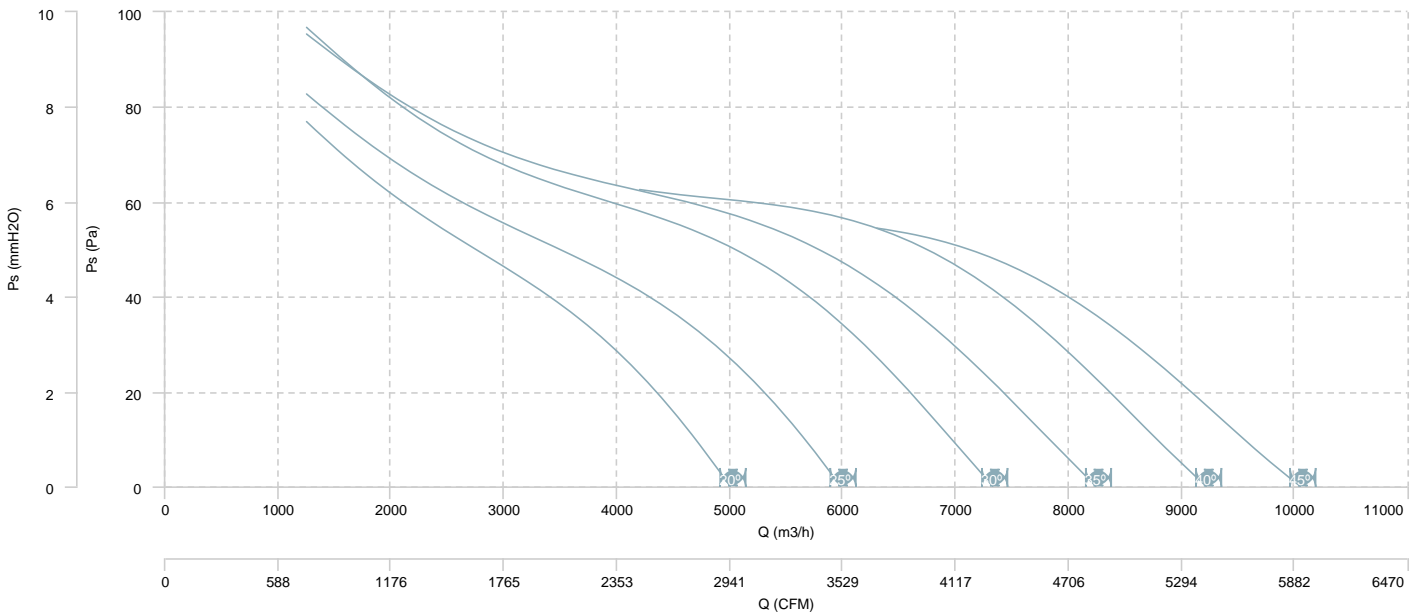

AIR FLOW - MECHANICAL POWER (8 poles)

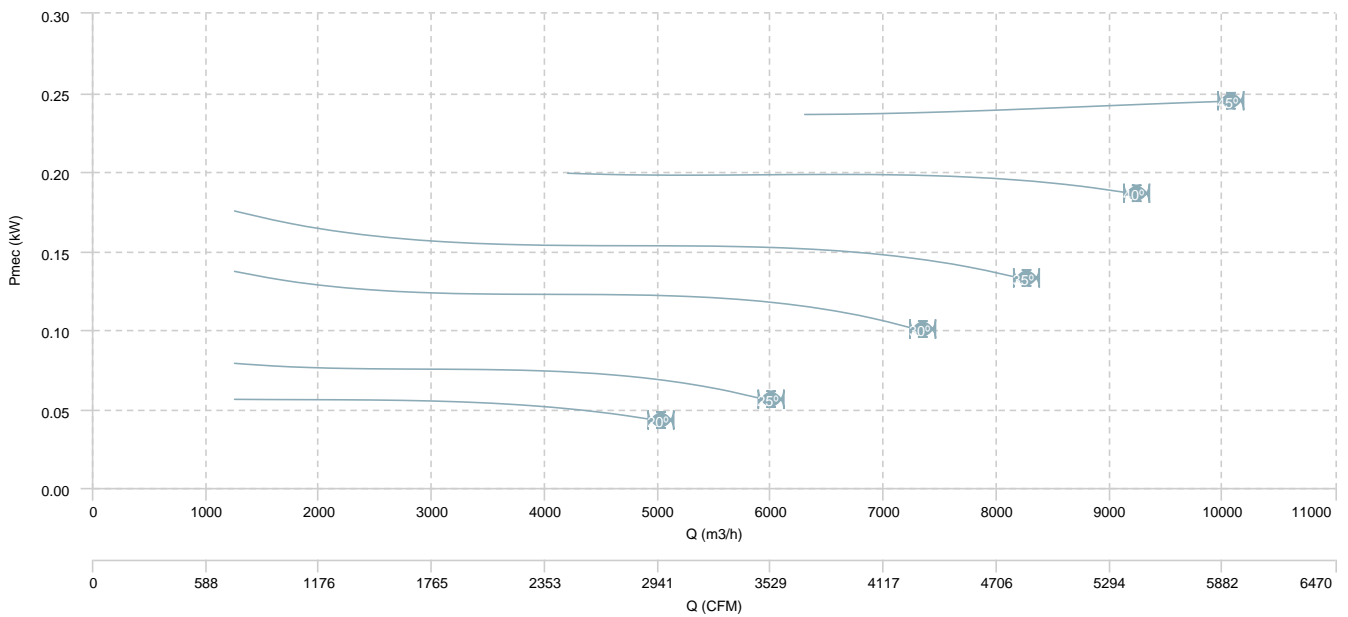

HMXF 71 T4 (A5:6) F400

AIR FLOW - PRESSURE

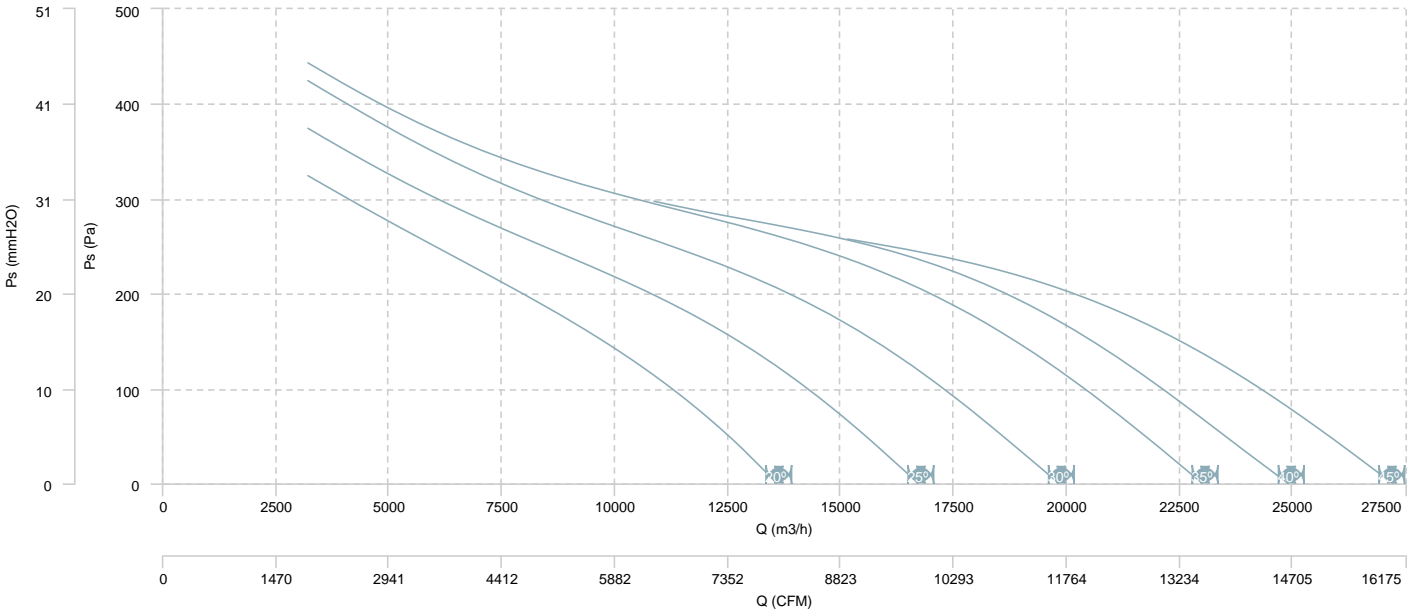

AIR FLOW - MECHANICAL POWER

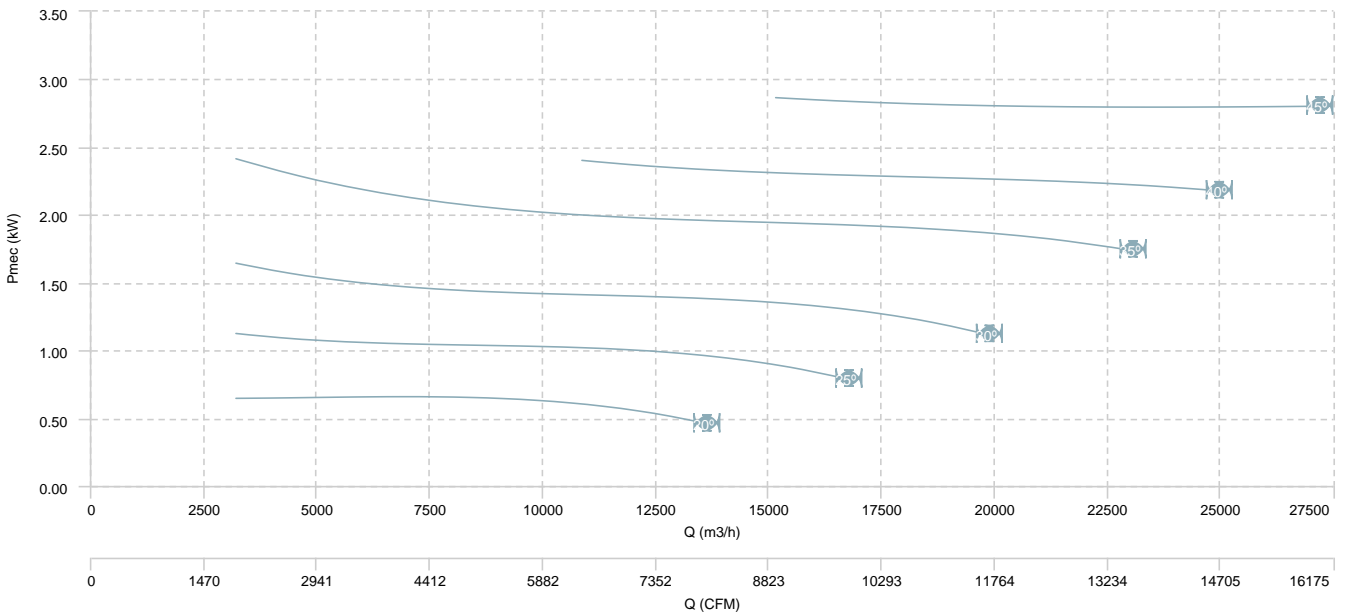

HMXF 71 T6 (A5:6) F400

AIR FLOW - PRESSURE

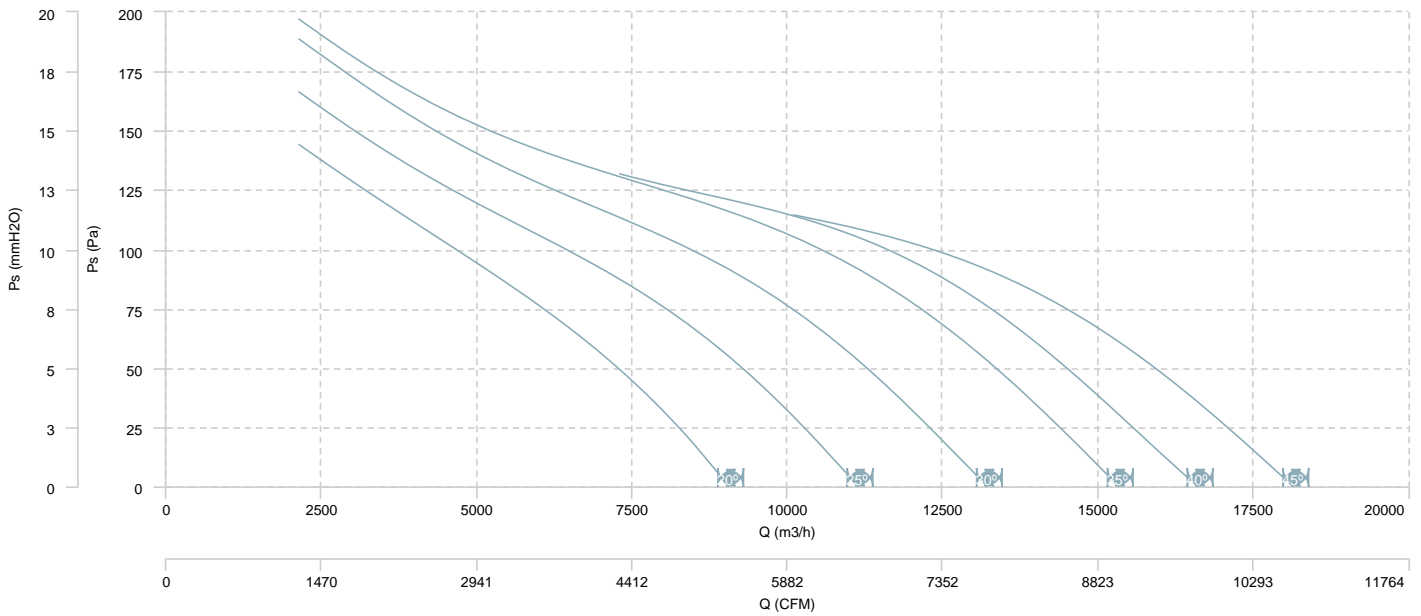

AIR FLOW - MECHANICAL POWER

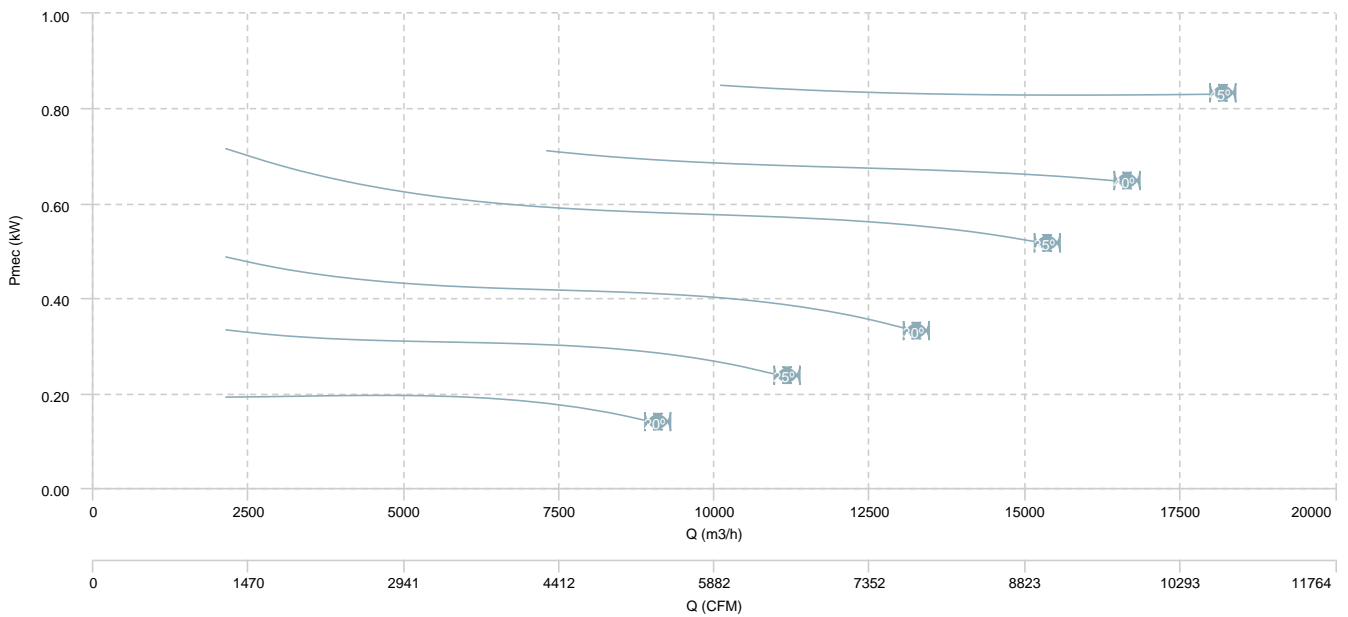

HMXF 71 T4/T6 (A5:6) F400

AIR FLOW - PRESSURE (4 poles)

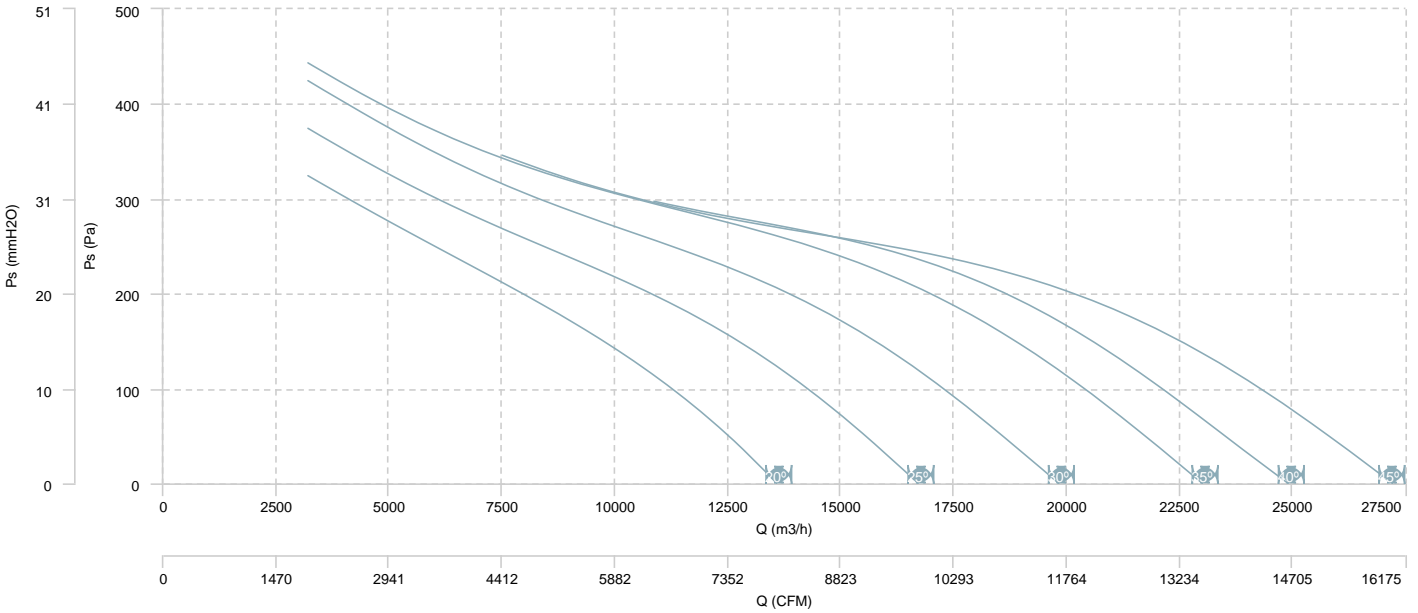

AIR FLOW - MECHANICAL POWER (4 poles)

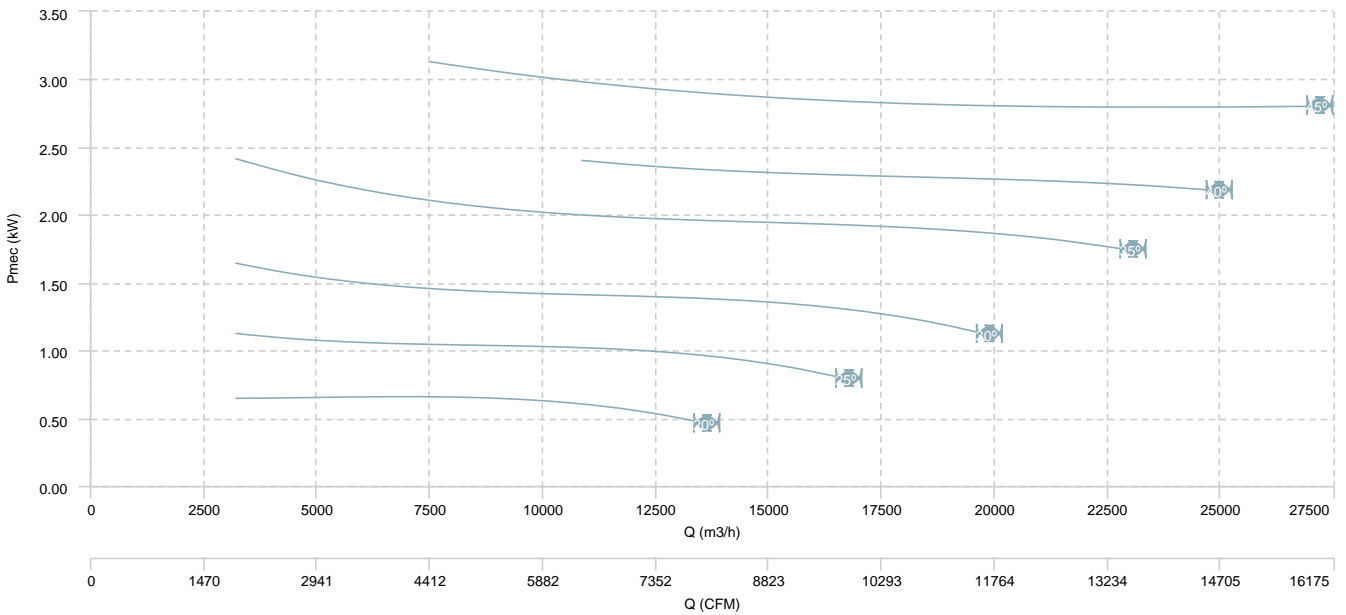

HMXF 71 T4/T6 (A5:6) F400

AIR FLOW - PRESSURE (6 poles)

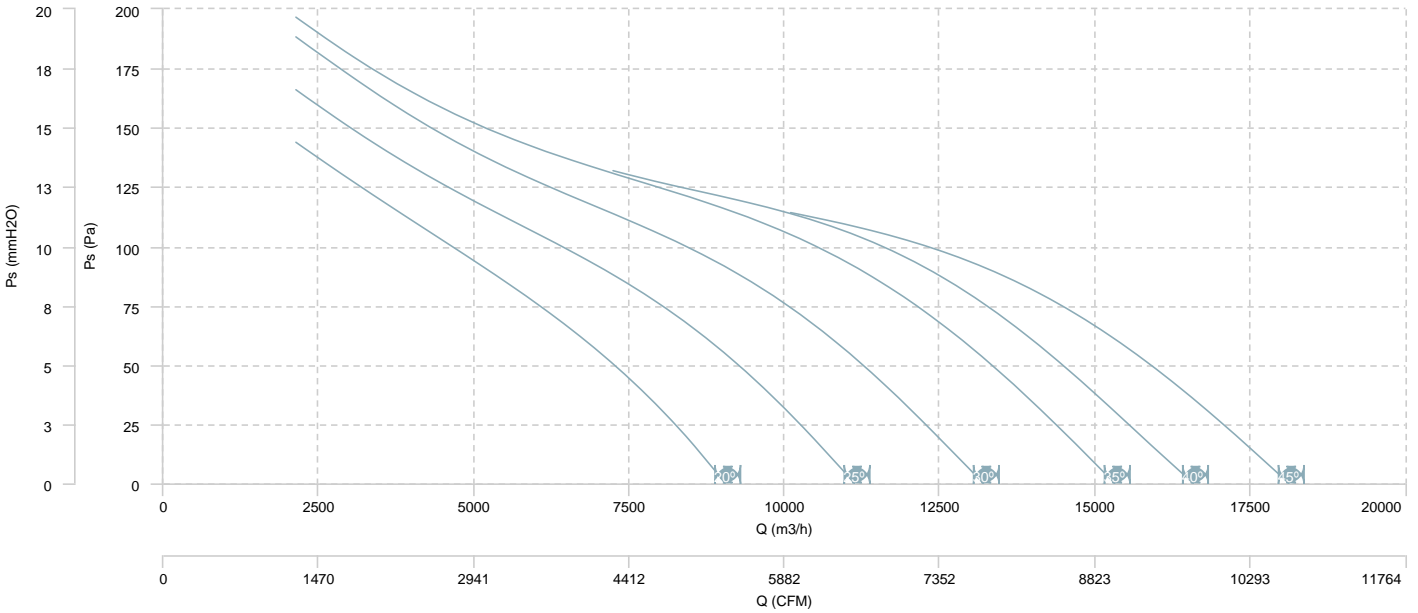

AIR FLOW - MECHANICAL POWER (6 poles)

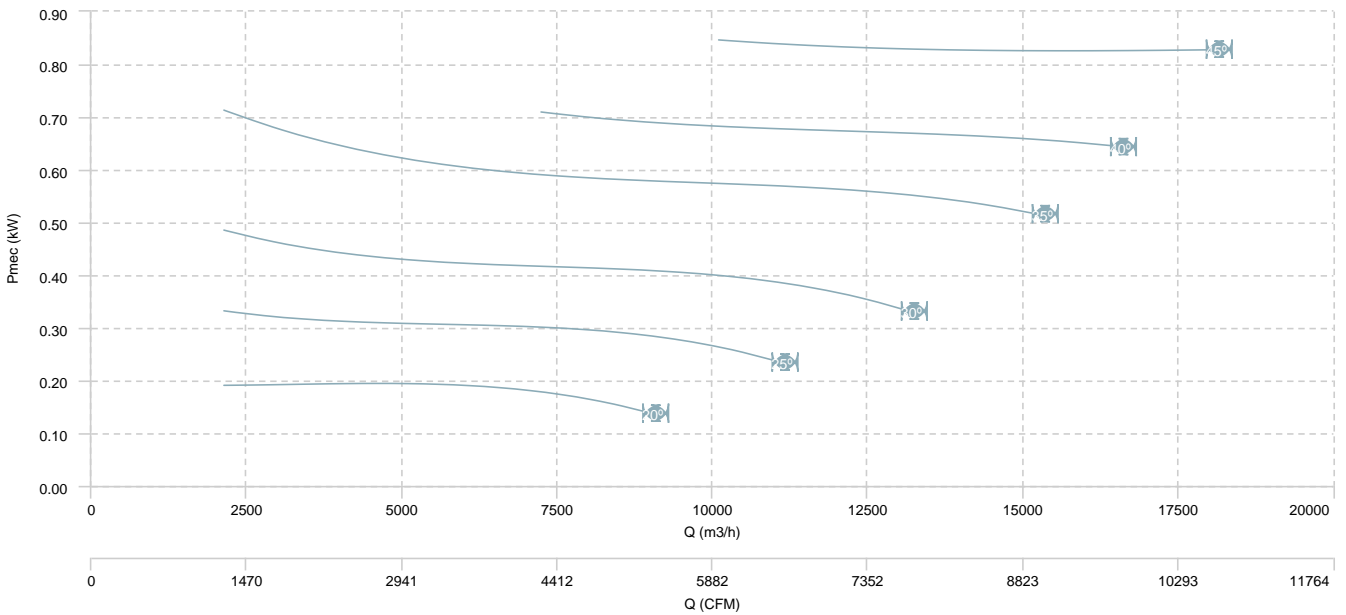



HMXF 71 T4/T8 (A5:6) F400

AIR FLOW - PRESSURE (4 poles)

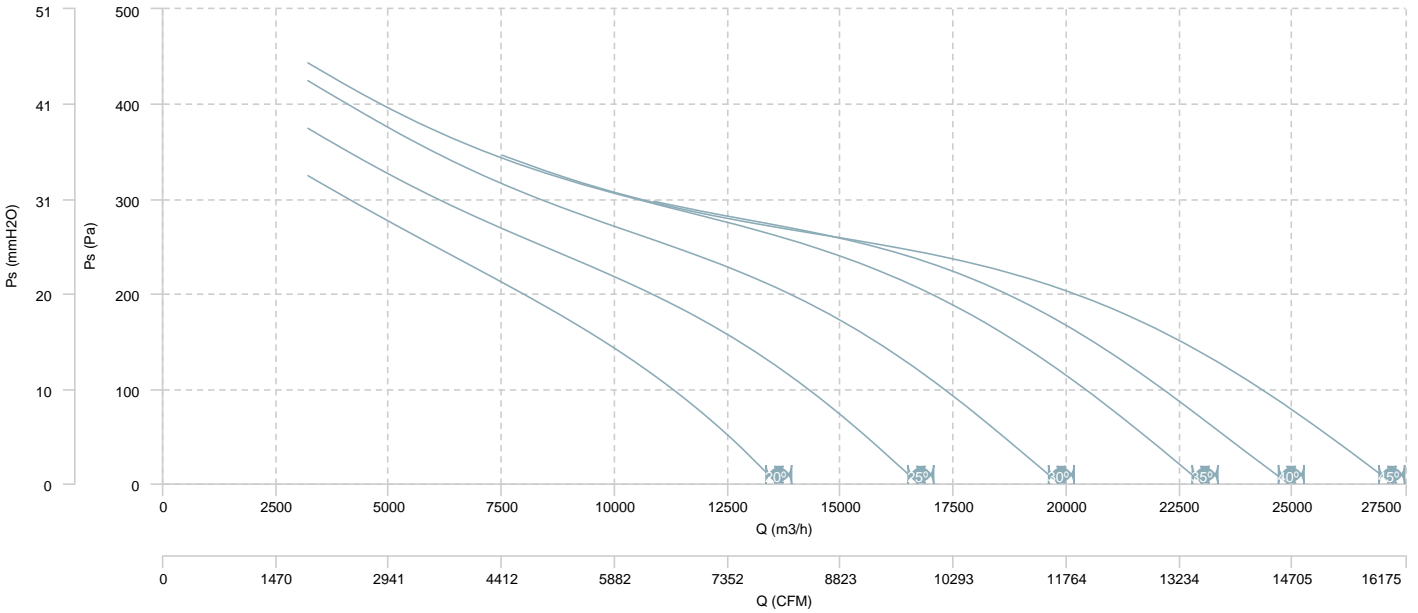

AIR FLOW - MECHANICAL POWER (4 poles)

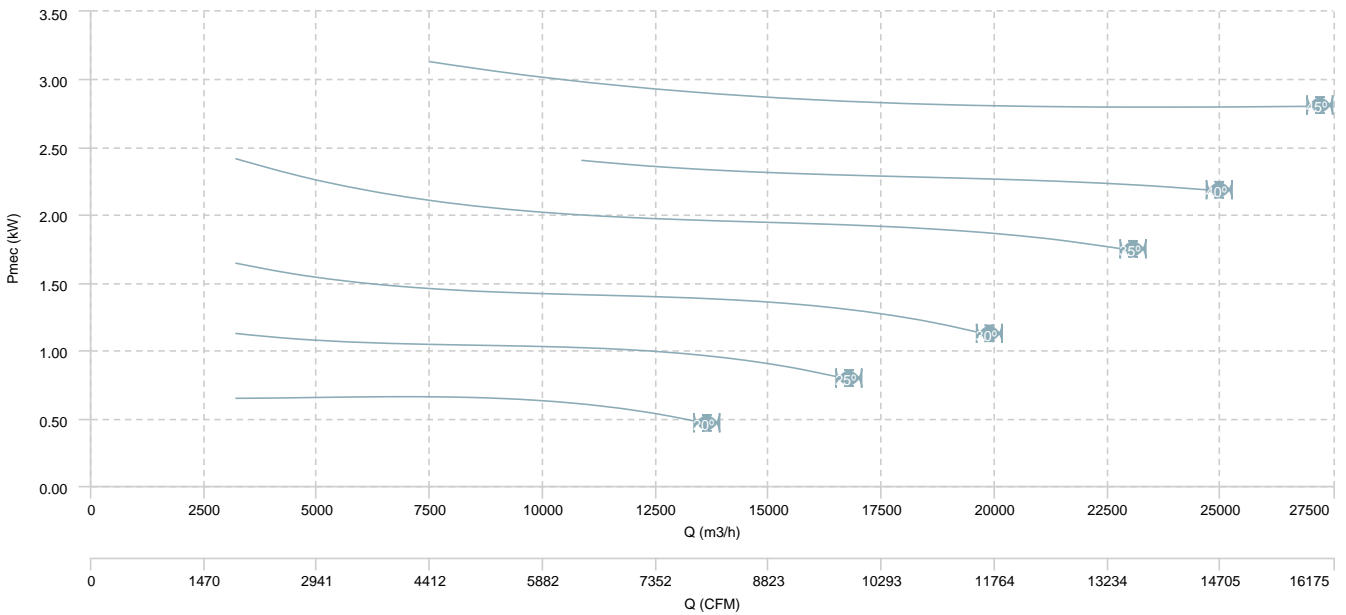

HMXF 71 T4/T8 (A5:6) F400

AIR FLOW - PRESSURE (8 poles)

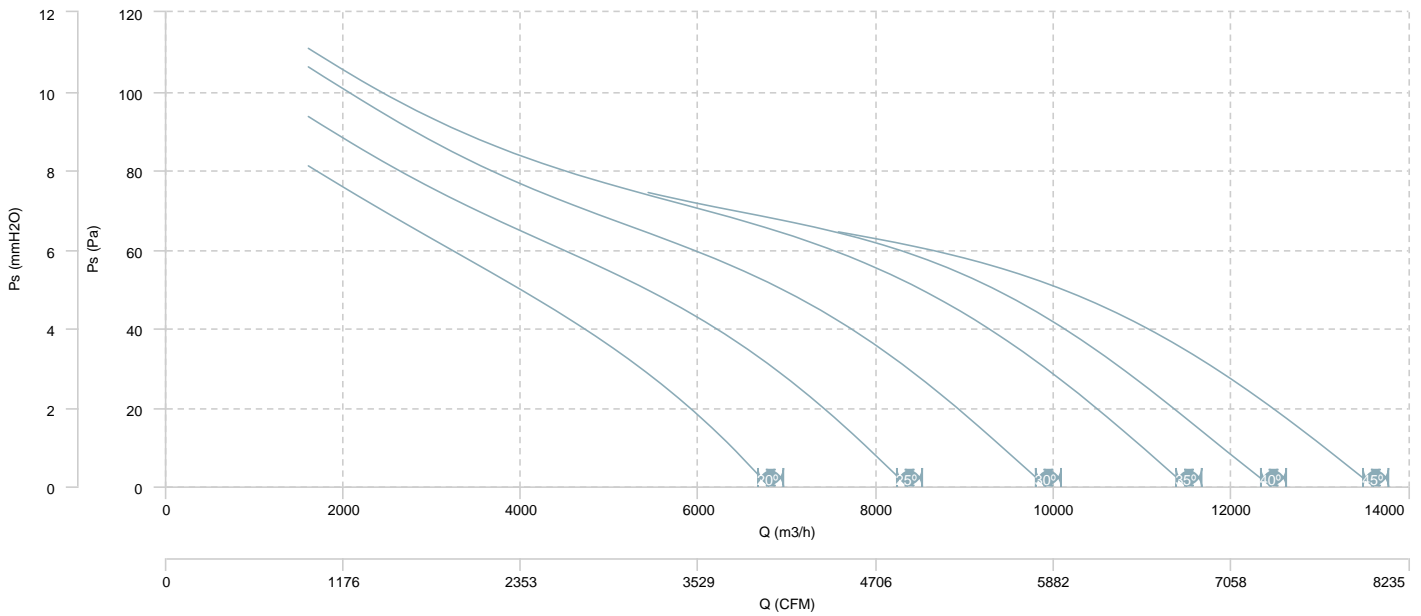

AIR FLOW - MECHANICAL POWER (8 poles)

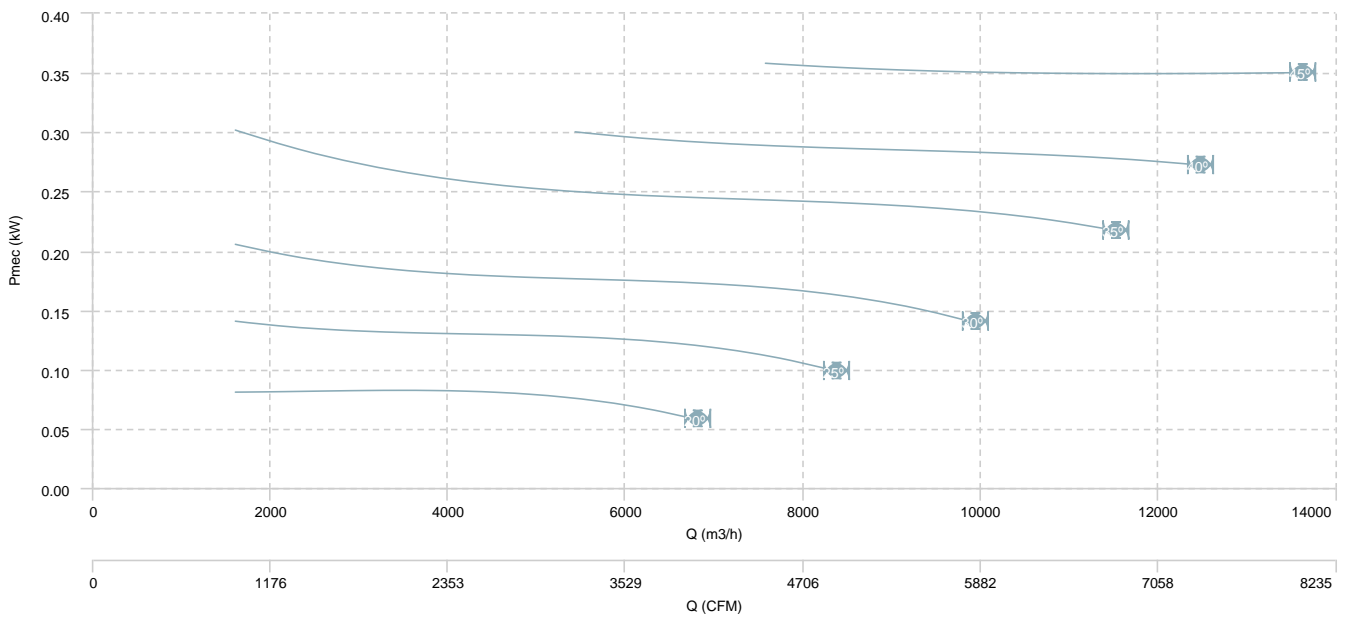

HMXF 80 T4 (A5:6) F400

AIR FLOW - PRESSURE

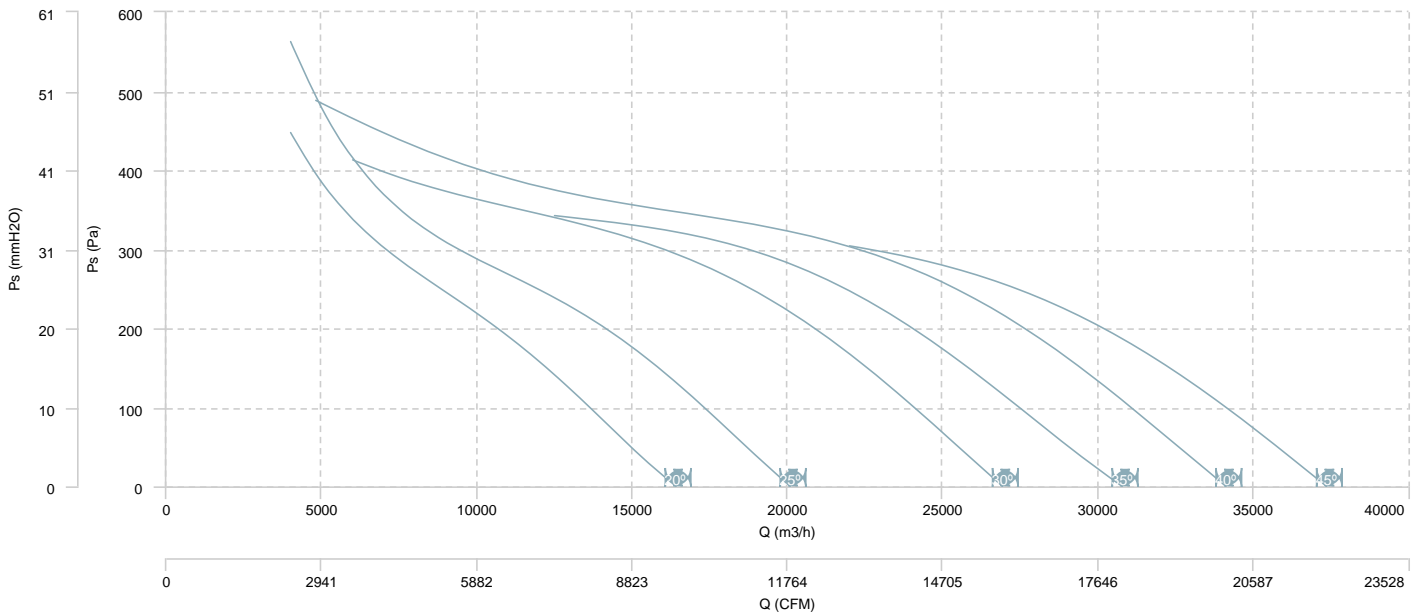

AIR FLOW - MECHANICAL POWER

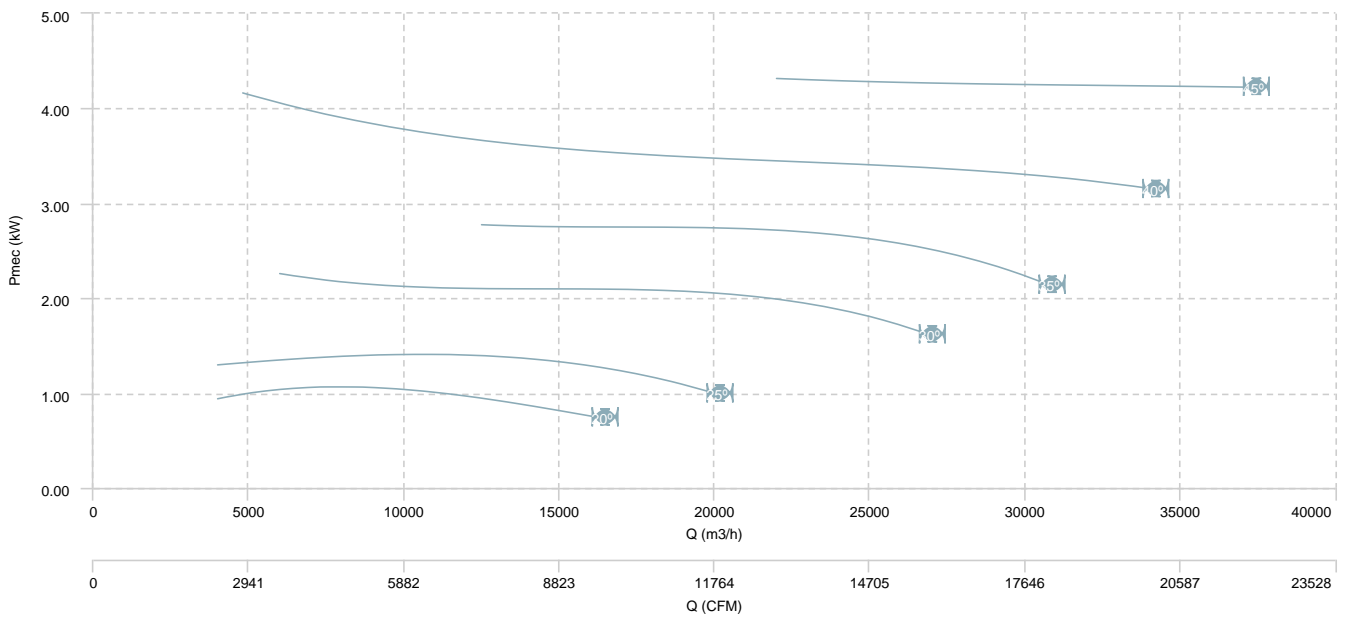

HMXF 80 T6 (A5:6) F400

AIR FLOW - PRESSURE

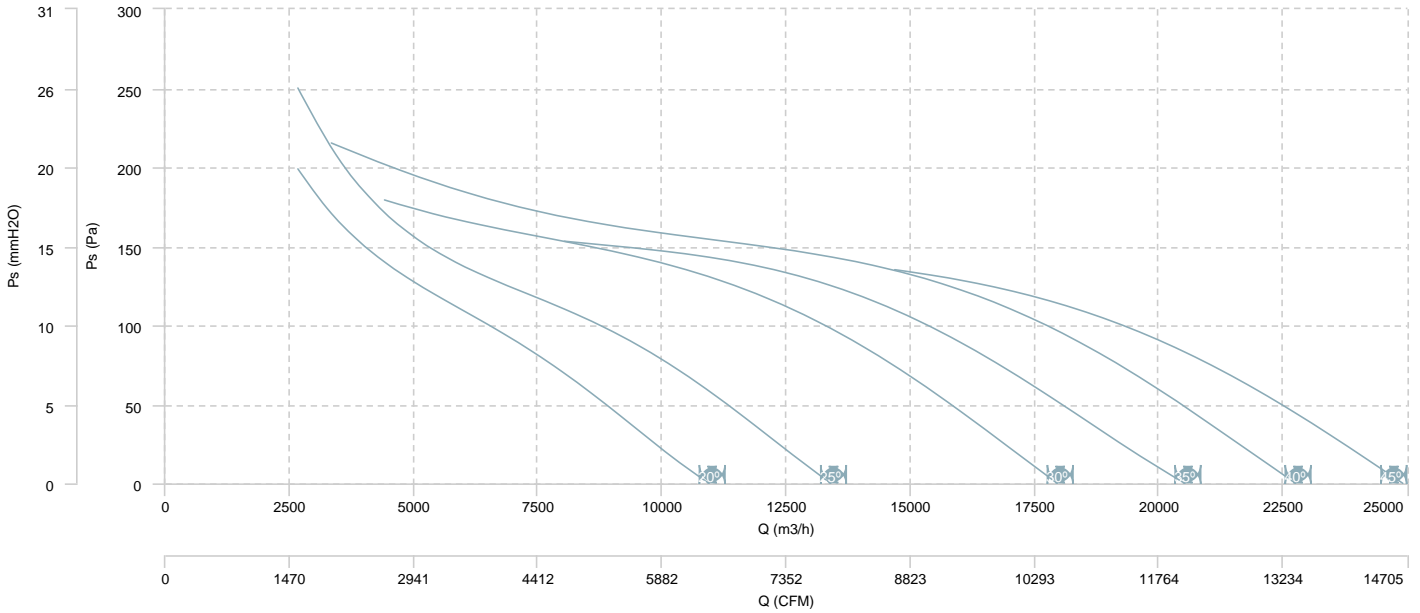

AIR FLOW - MECHANICAL POWER

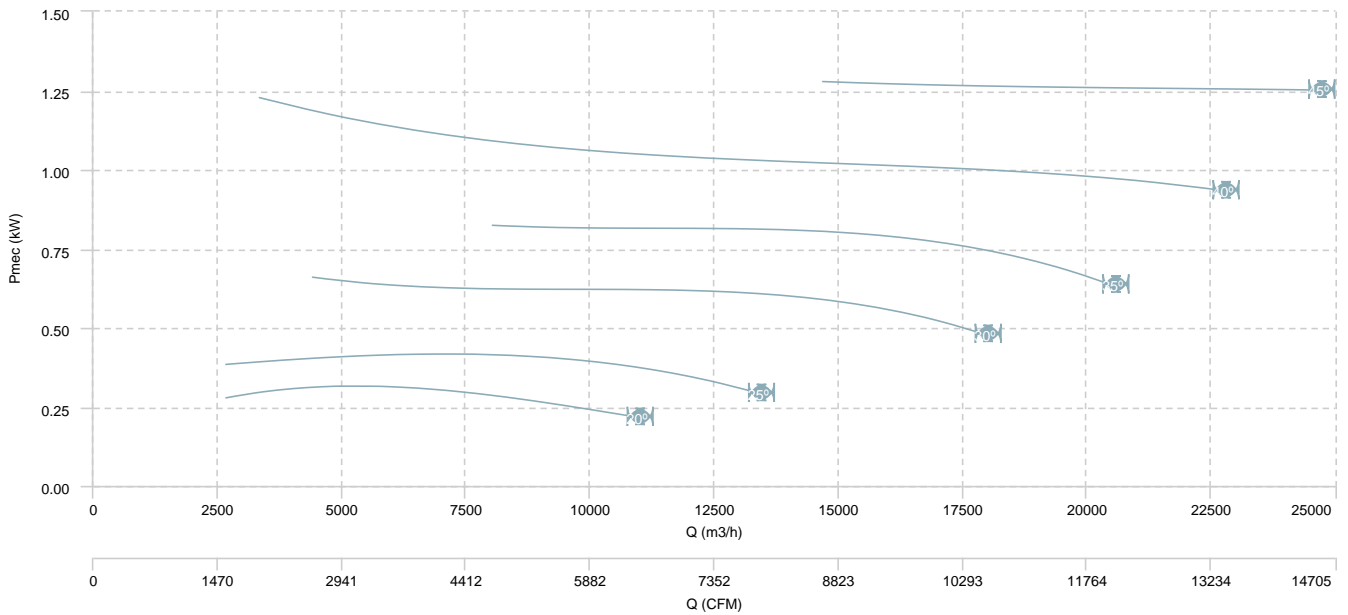

HMXF 80 T4/T6 (A5:6) F400

AIR FLOW - PRESSURE (4 poles)

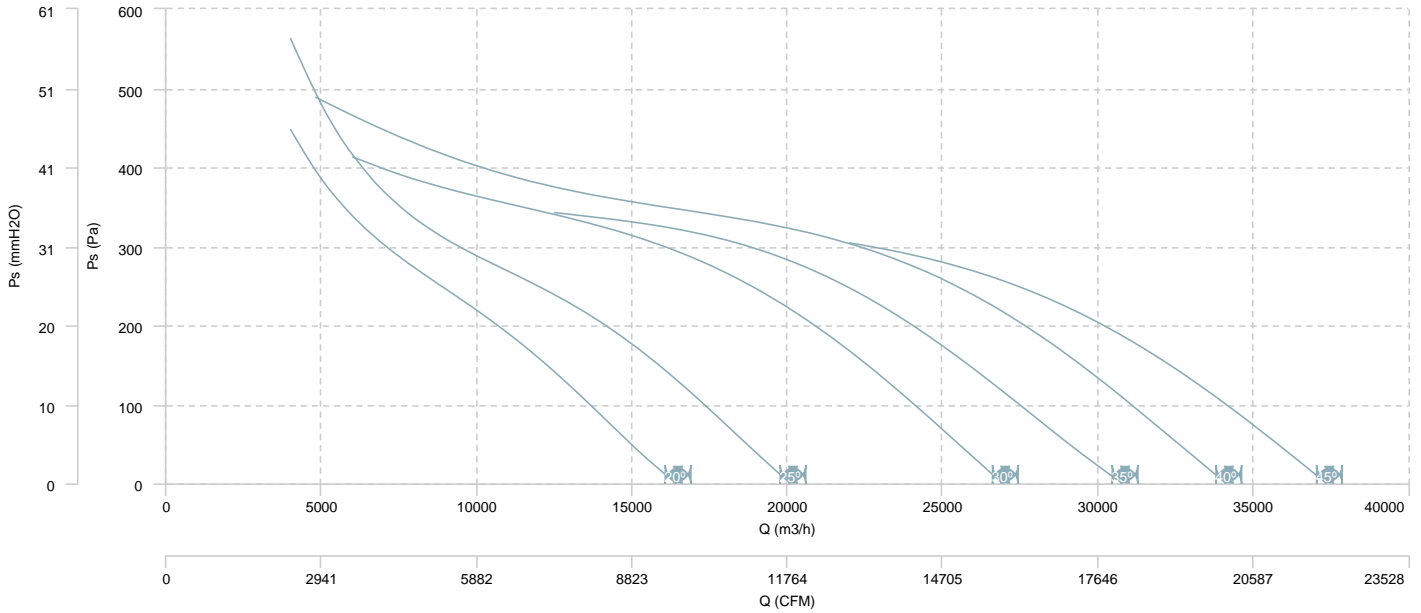

AIR FLOW - MECHANICAL POWER (4 poles)

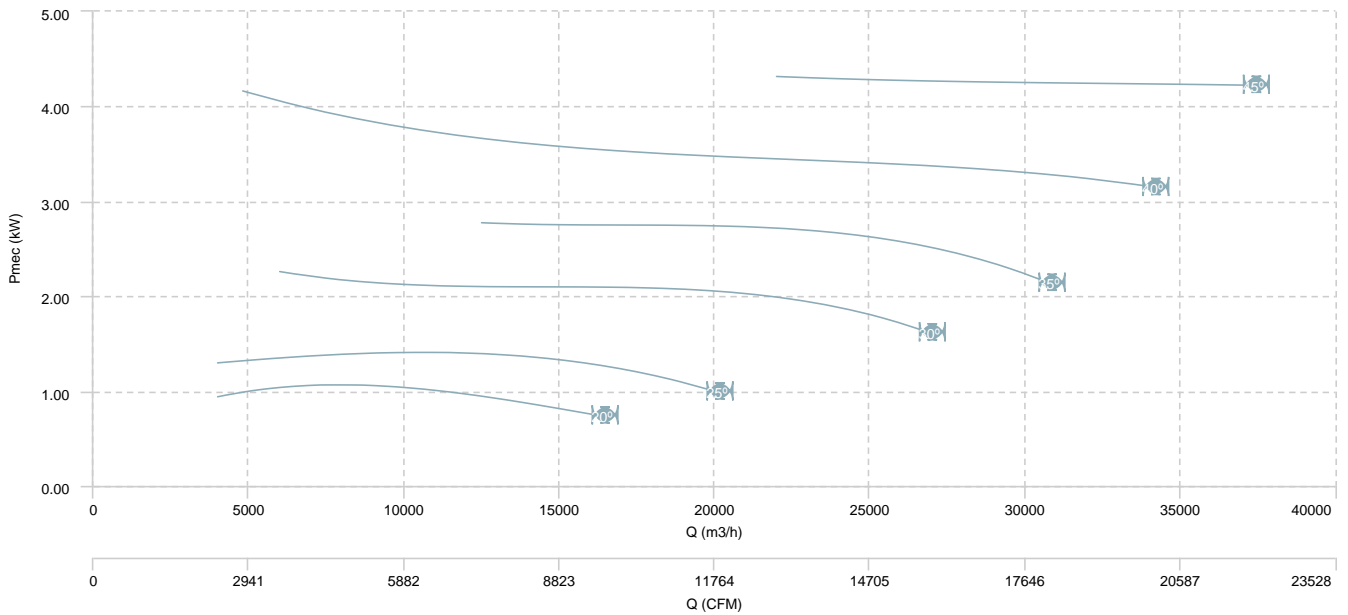

HMXF 80 T4/T6 (A5:6) F400

AIR FLOW - PRESSURE (6 poles)

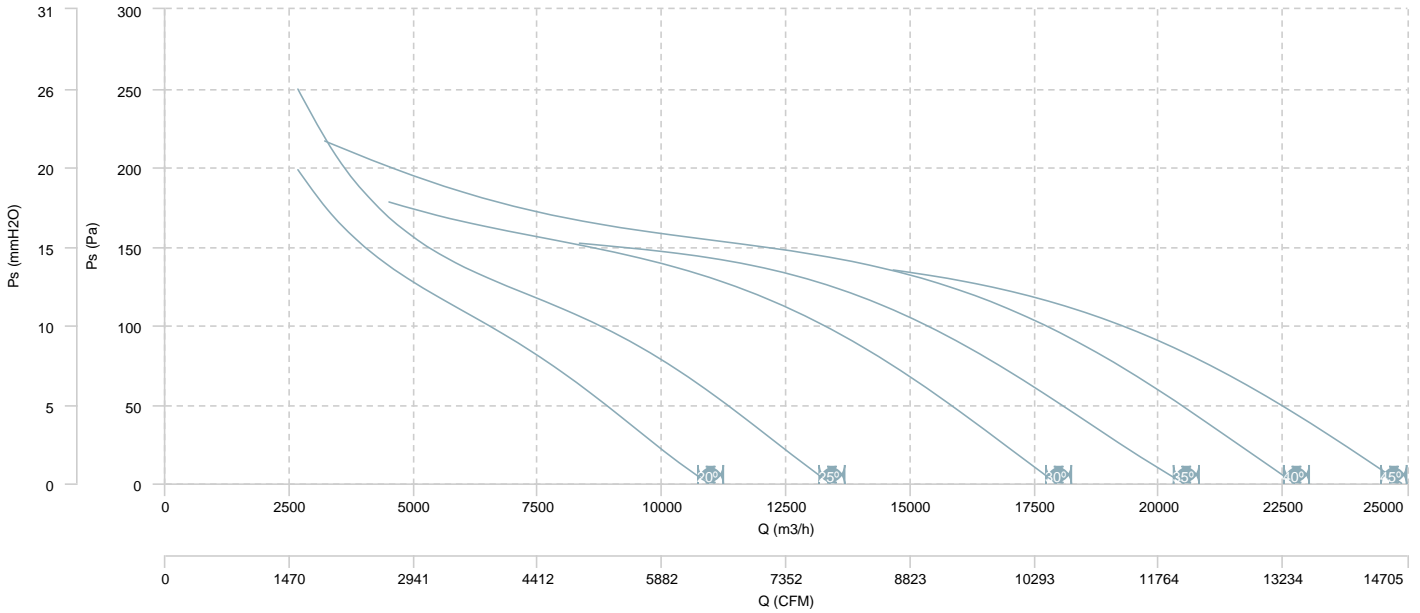

AIR FLOW - MECHANICAL POWER (6 poles)

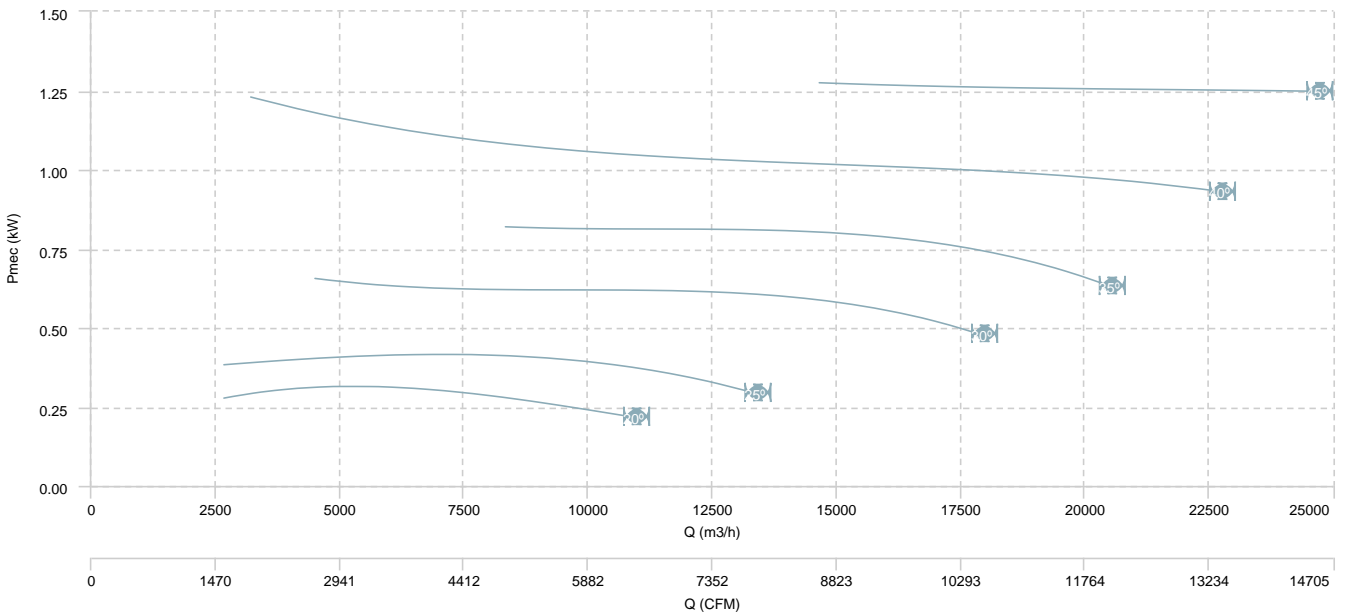

HMXF 80 T4/T8 (A5:6) F400

AIR FLOW - PRESSURE (4 poles)

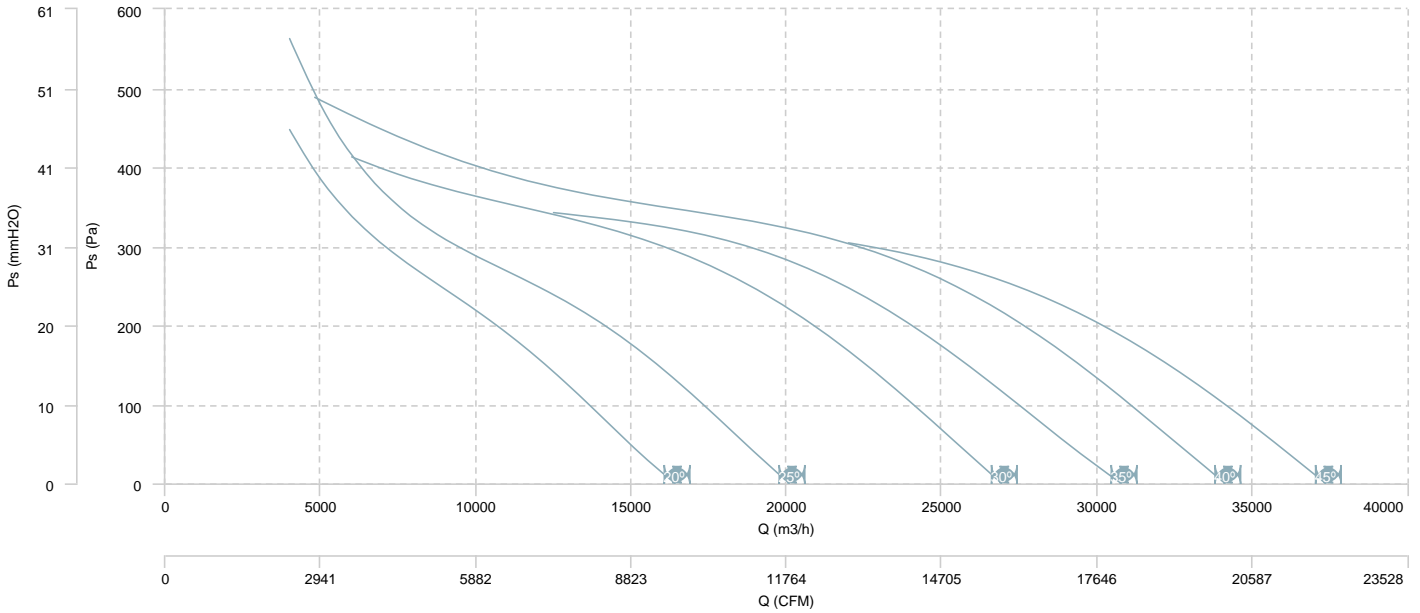

AIR FLOW - MECHANICAL POWER (4 poles)

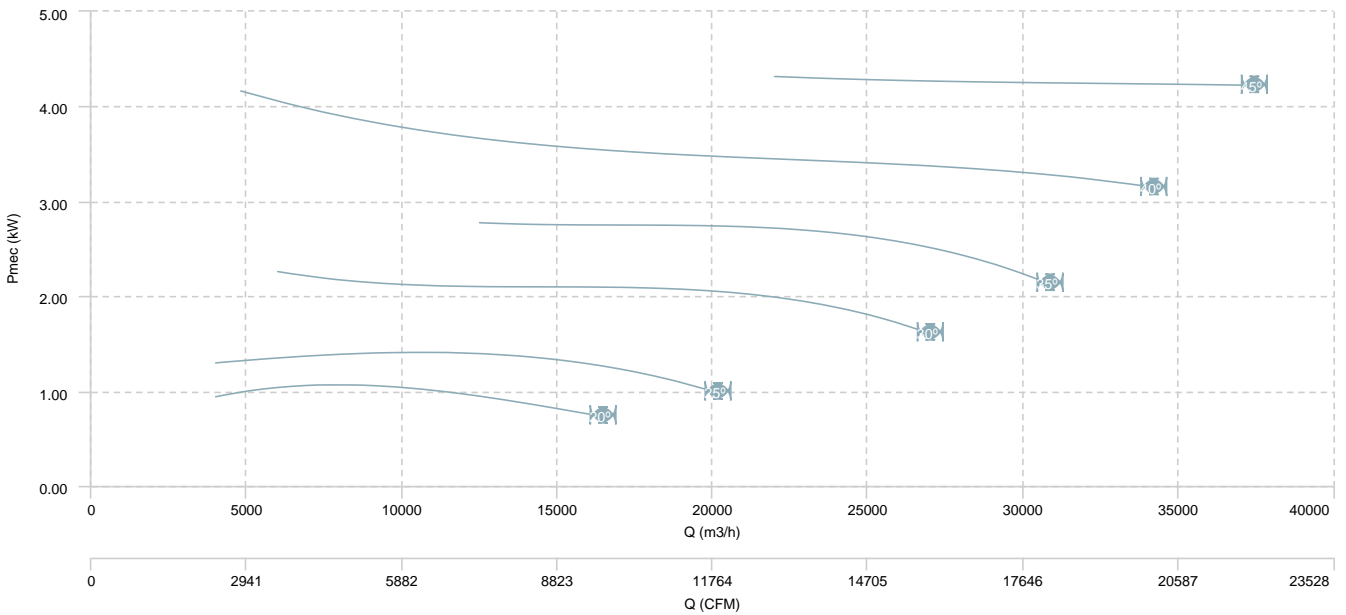

HMXF 80 T4/T8 (A5:6) F400

AIR FLOW - PRESSURE (8 poles)

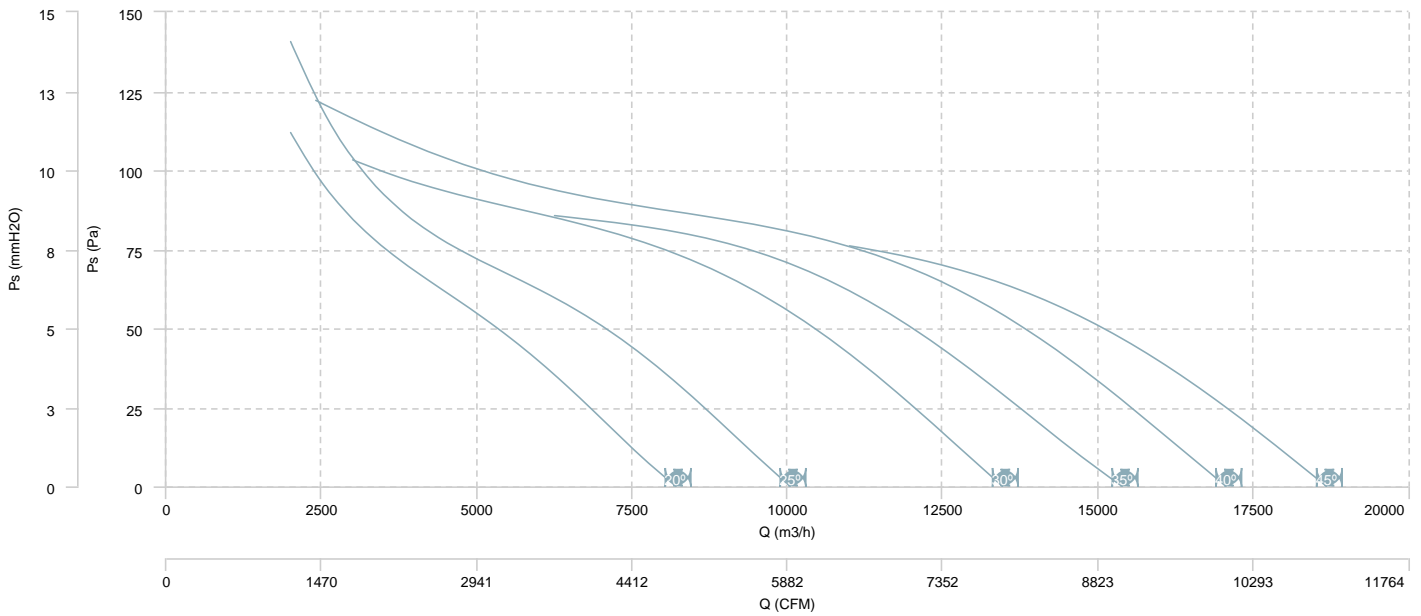

AIR FLOW - MECHANICAL POWER (8 poles)

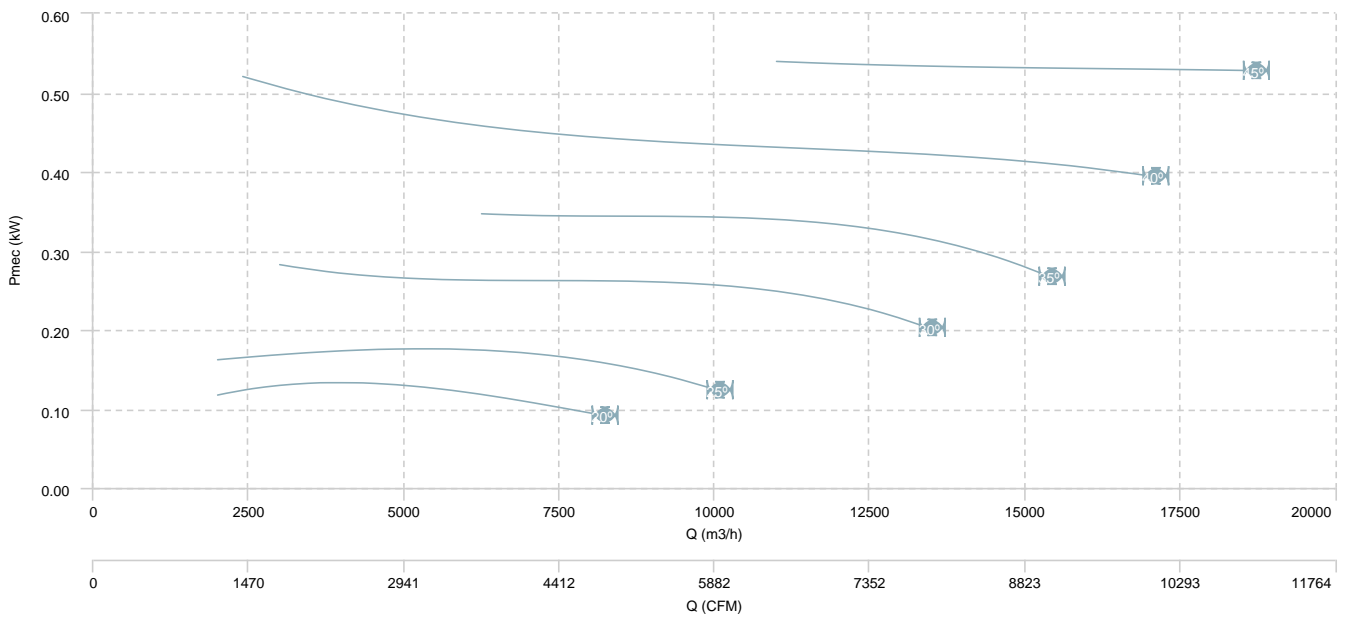



HMXF 90 T4 (A3:4) F400

AIR FLOW - PRESSURE

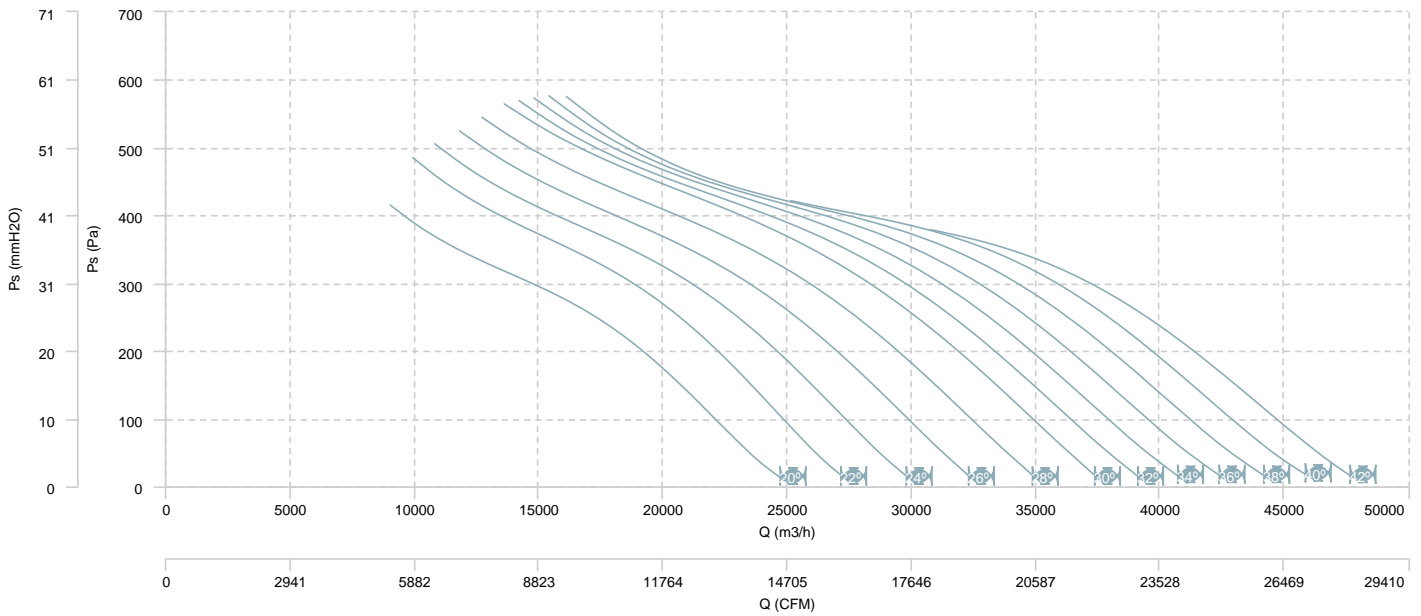

AIR FLOW - MECHANICAL POWER

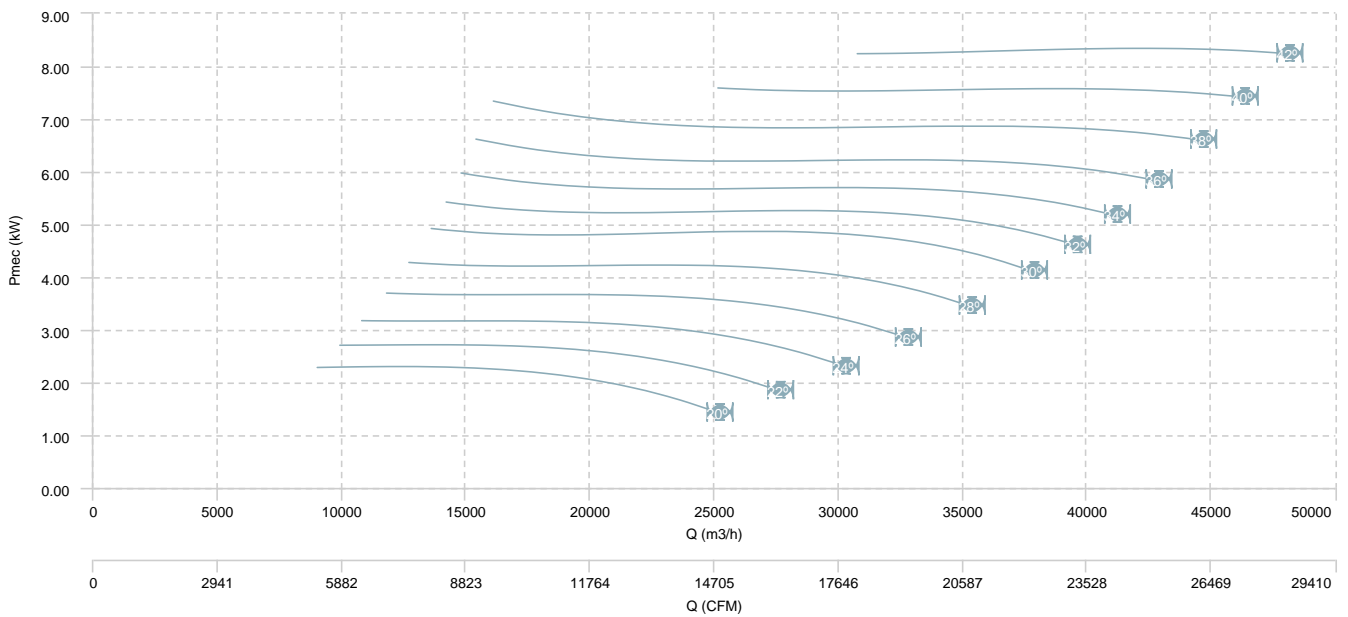

HMXF 90 T4 (A3:8) F400

AIR FLOW - PRESSURE

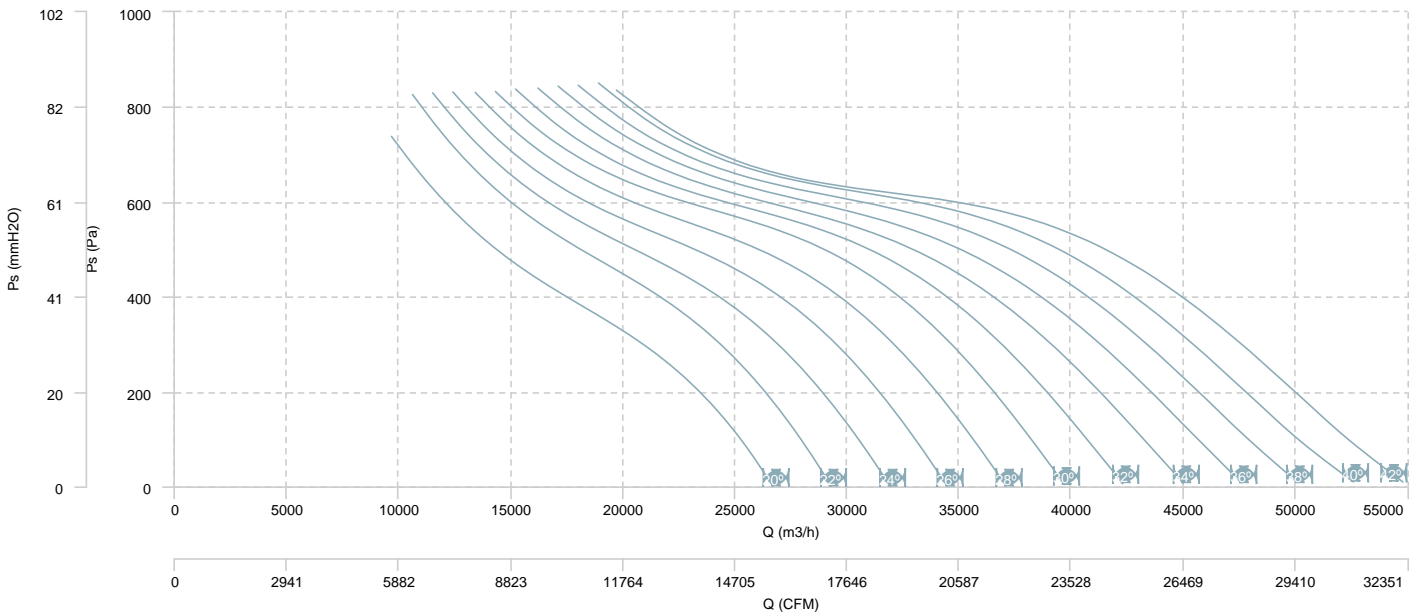

AIR FLOW - MECHANICAL POWER

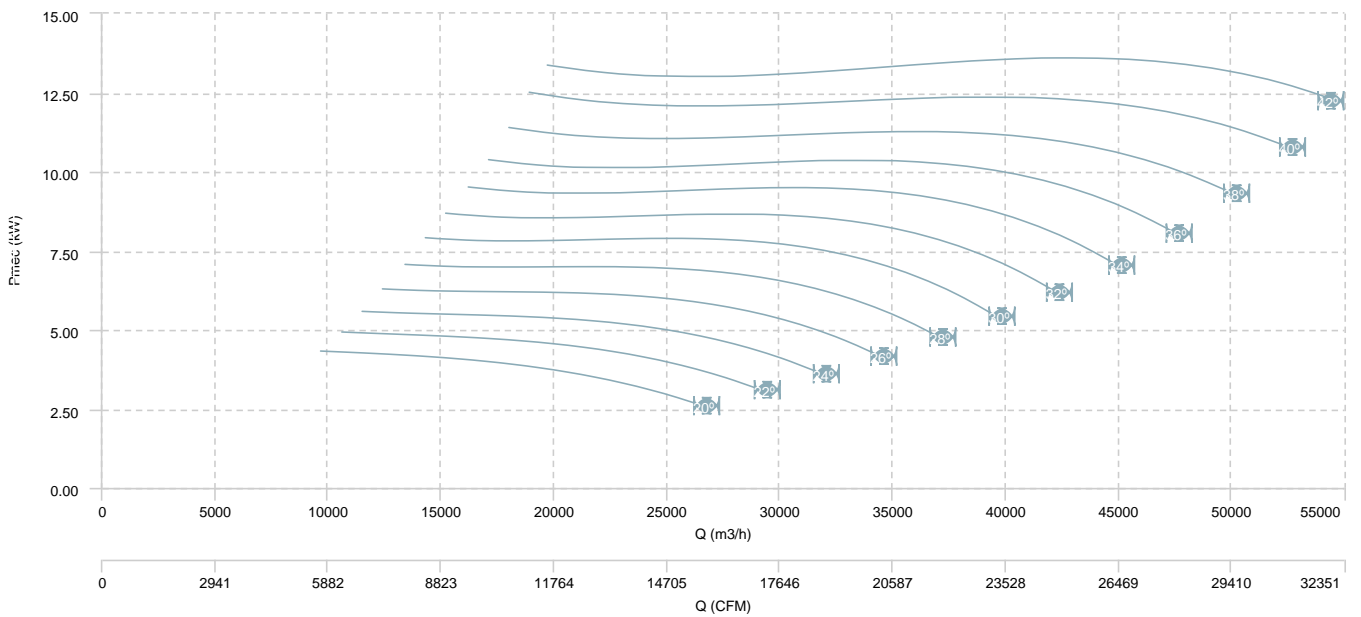

HMX 90 T6 (A3:4) F400

AIR FLOW - PRESSURE

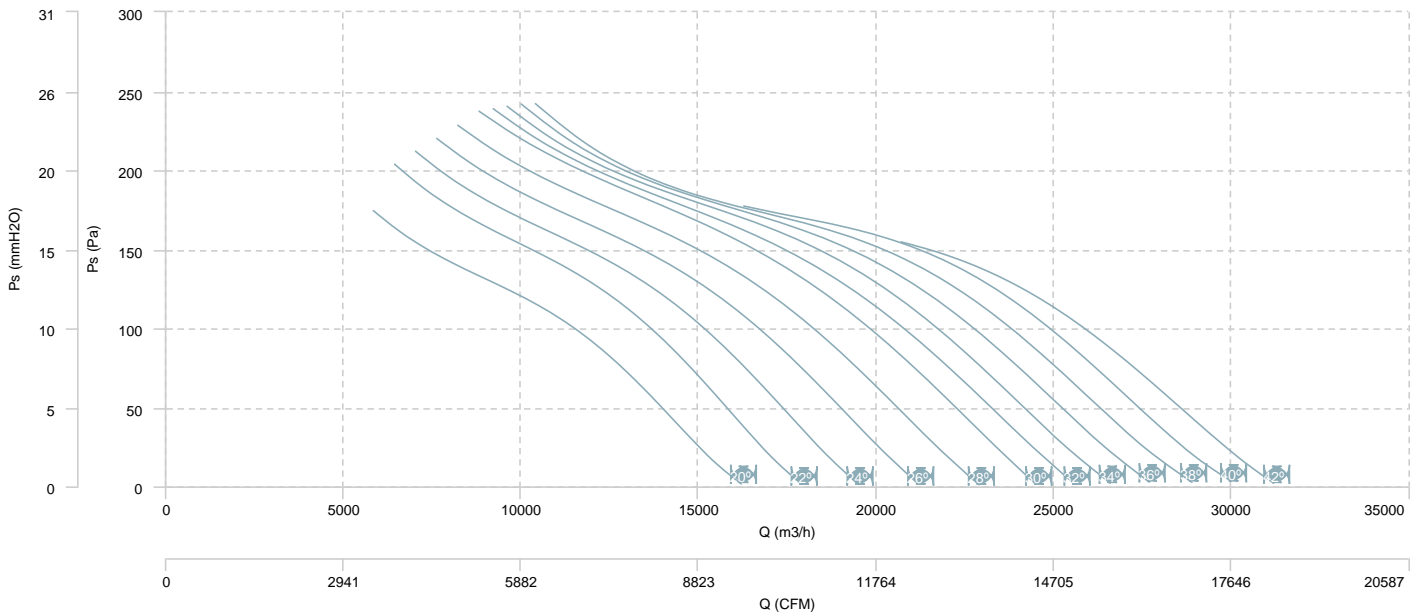

AIR FLOW - MECHANICAL POWER

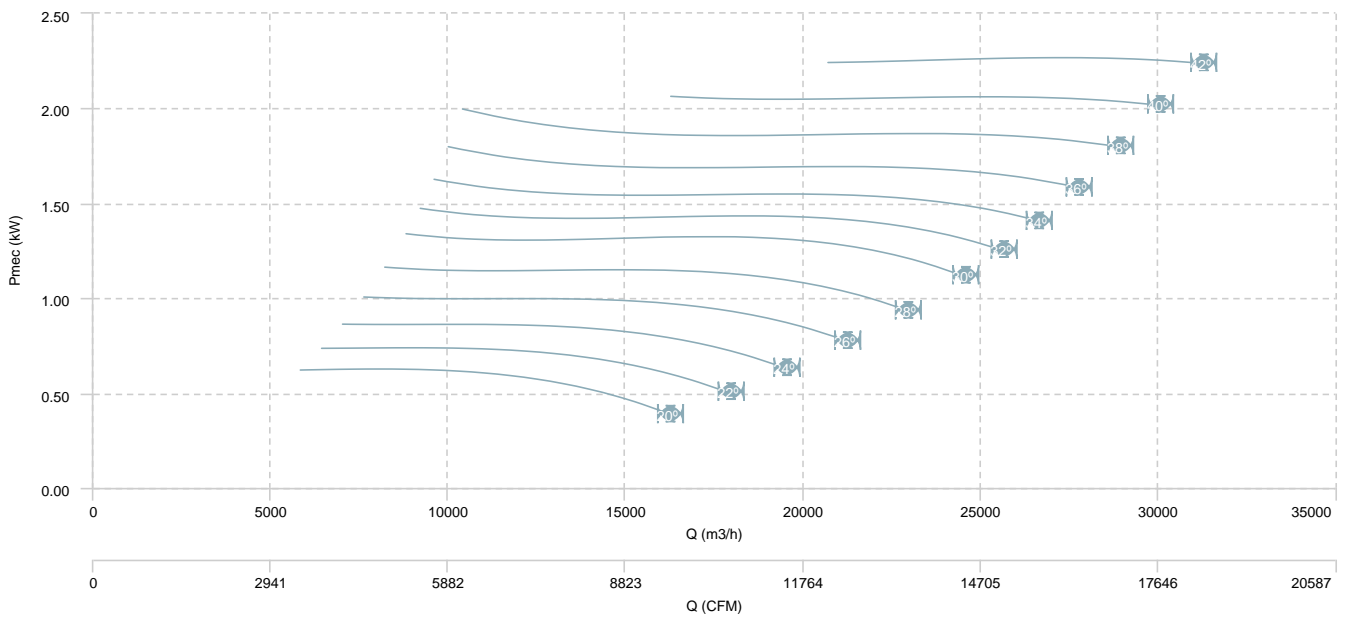

HMXF 90 T6 (A3:8) F400

AIR FLOW - PRESSURE

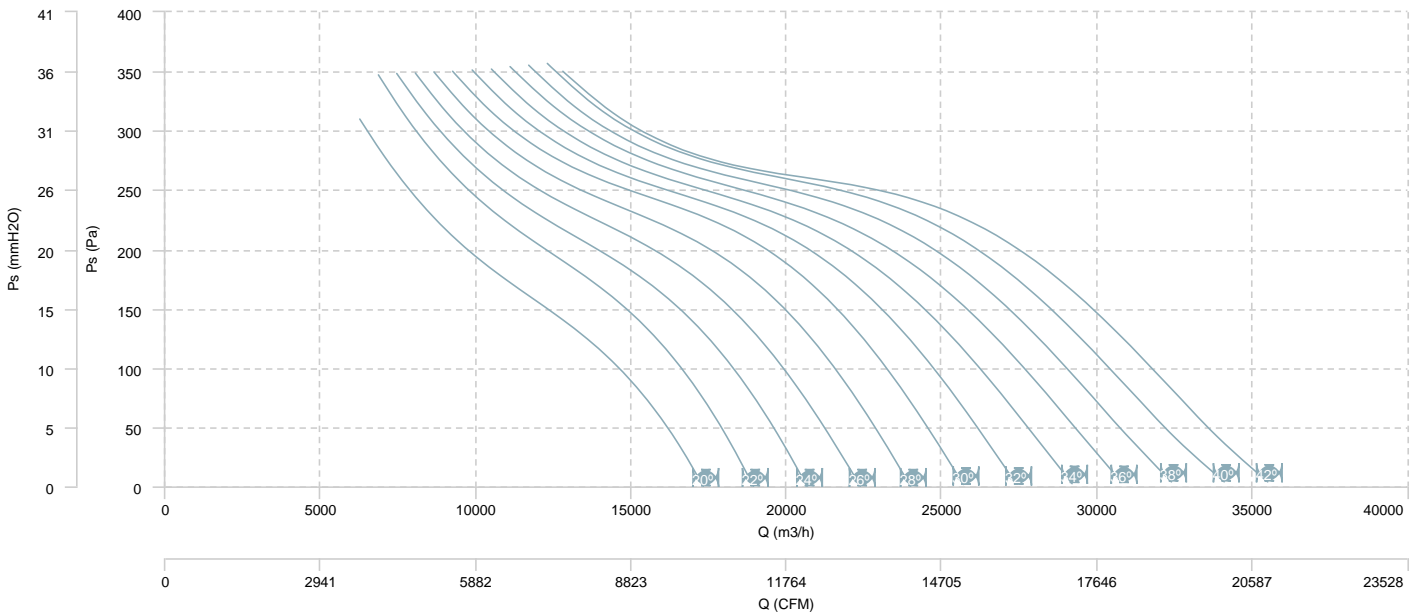

AIR FLOW - MECHANICAL POWER

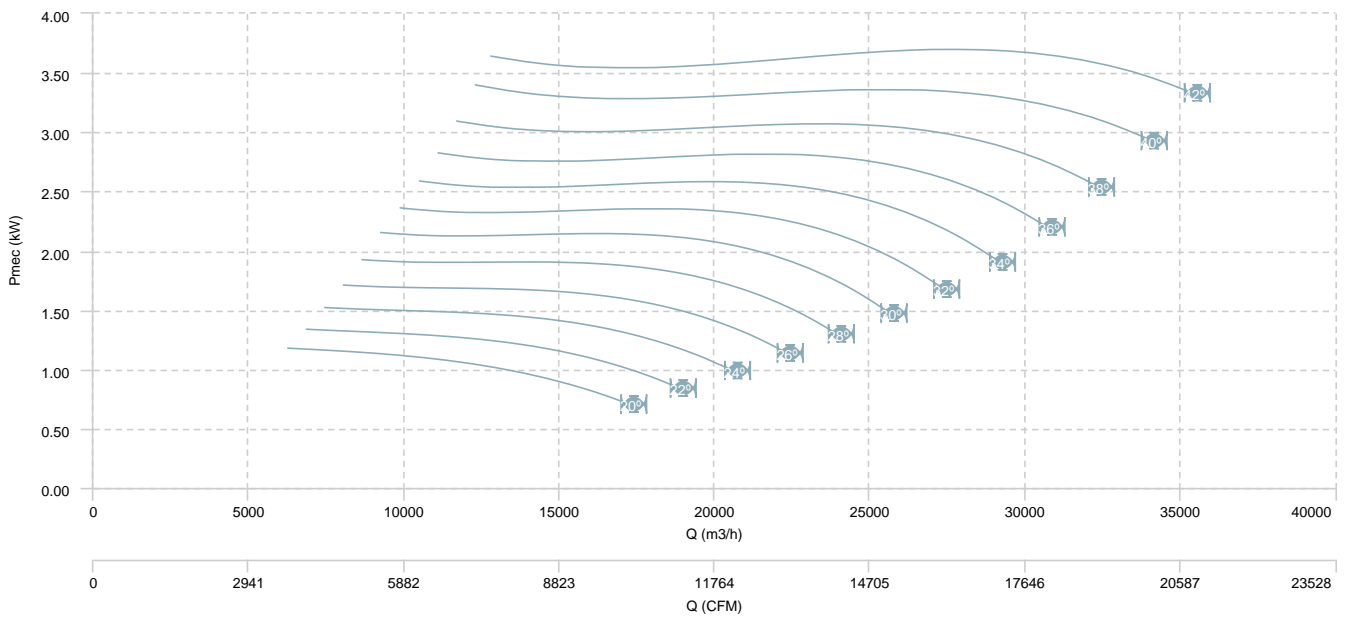

HMX 90 T4/T6 (A3:8) F400

AIR FLOW - PRESSURE (4 poles)

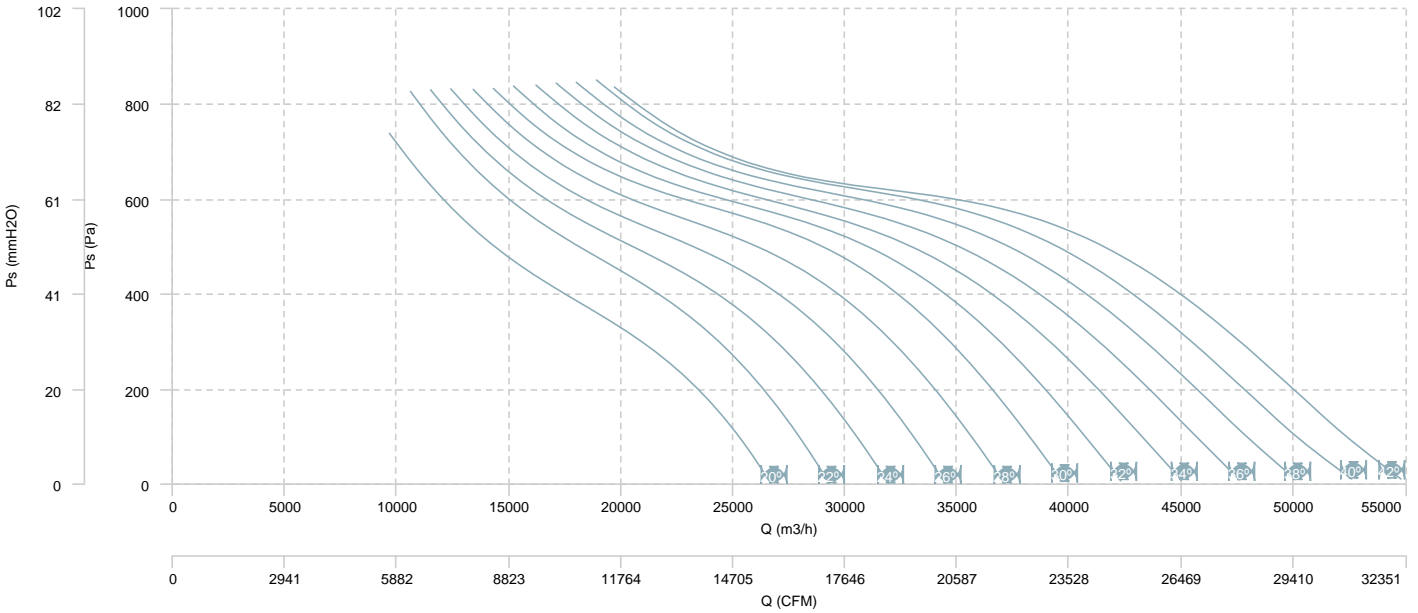

AIR FLOW - MECHANICAL POWER (4 poles)

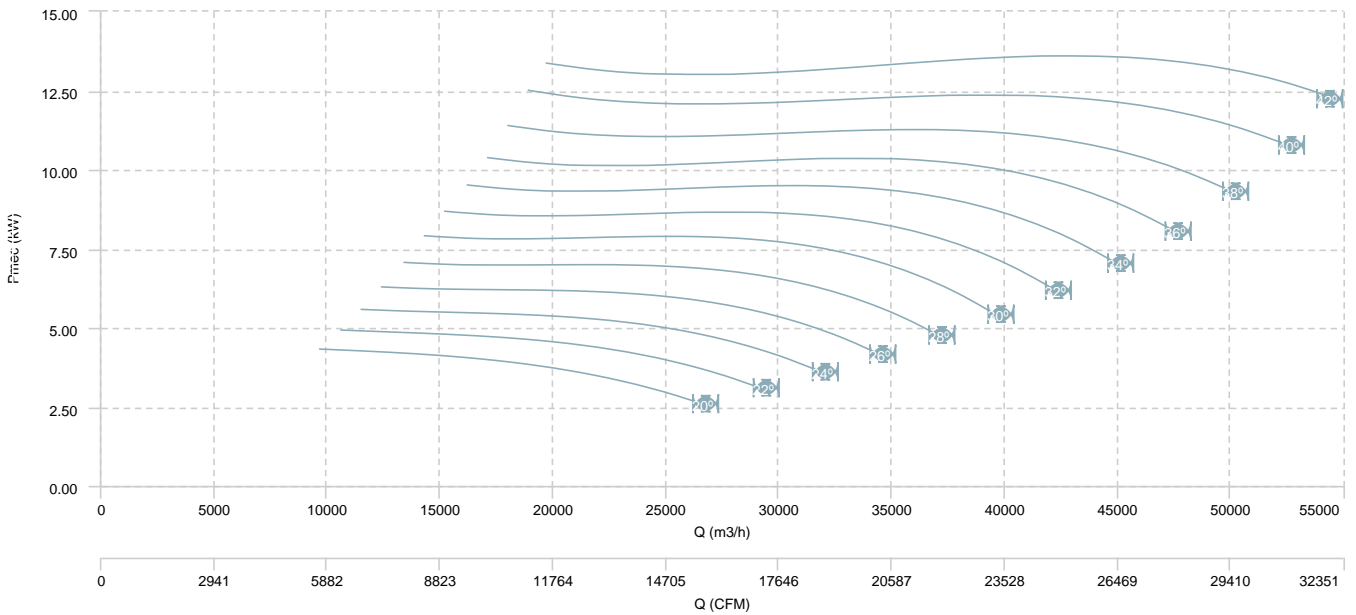

HMXF 90 T4/T6 (A3:8) F400

AIR FLOW - PRESSURE (6 poles)

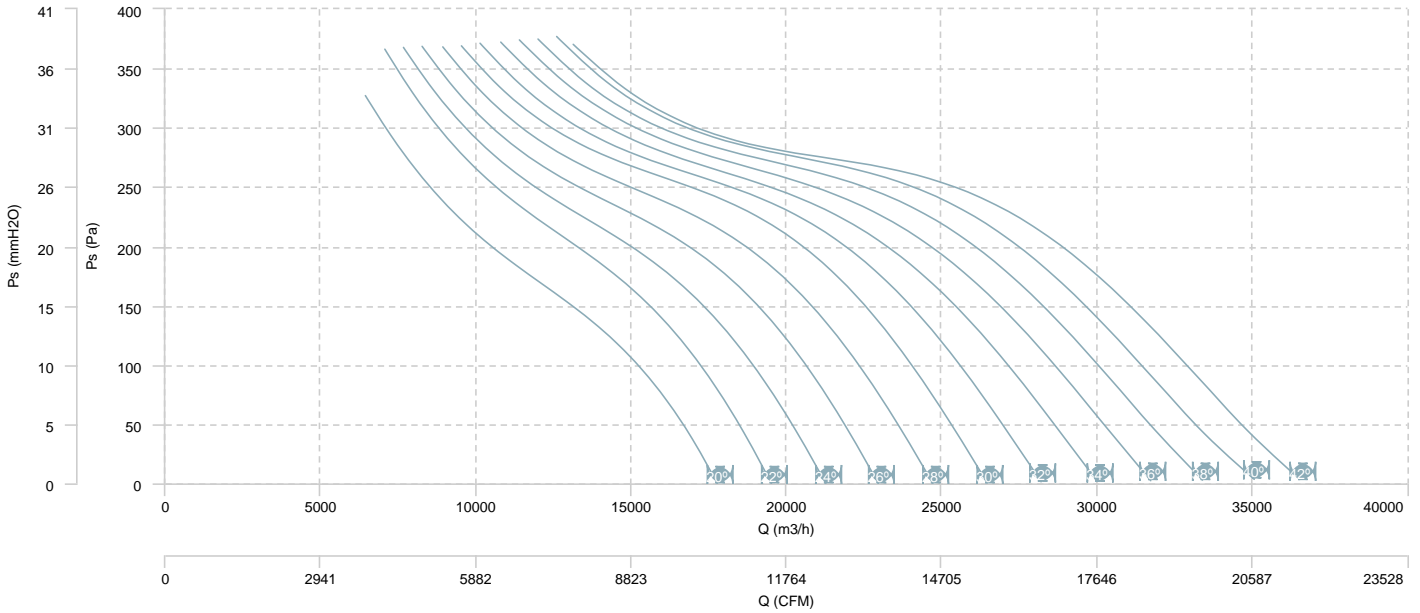

AIR FLOW - MECHANICAL POWER (6 poles)

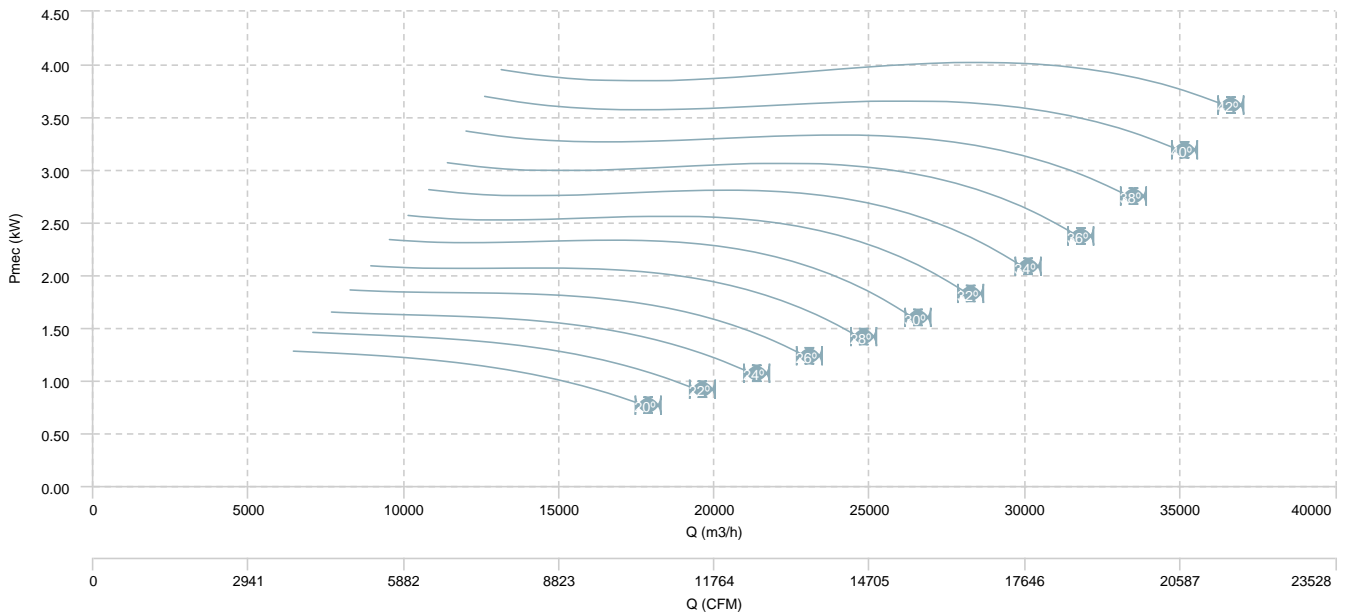

HMXF 90 T4/T6 (A3:4) F400

AIR FLOW - PRESSURE (4 poles)

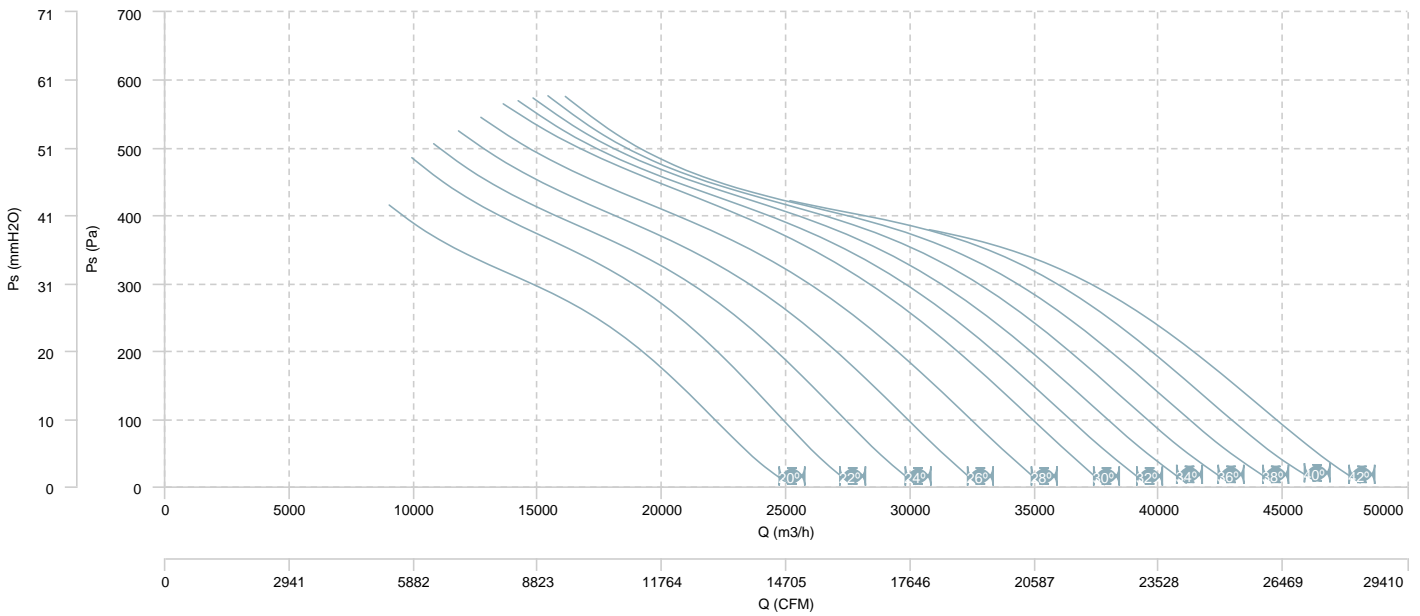

AIR FLOW - MECHANICAL POWER (4 poles)

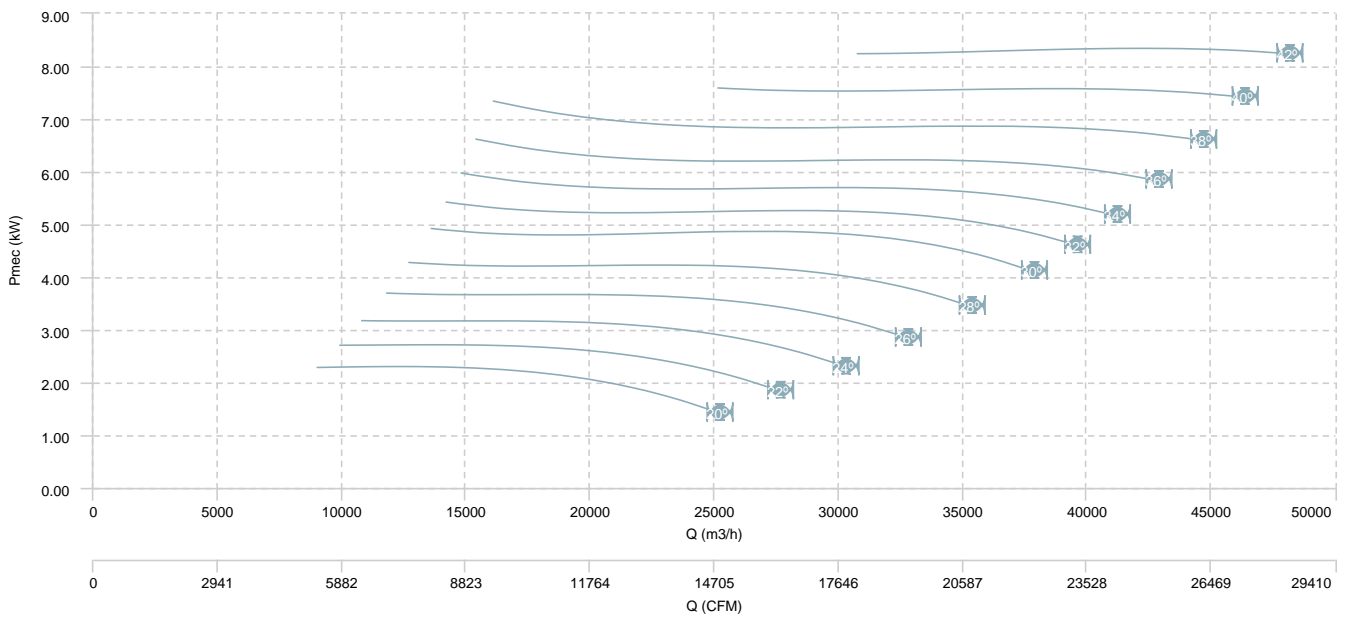

HMXF 90 T4/T6 (A3:4) F400

AIR FLOW - PRESSURE (6 poles)

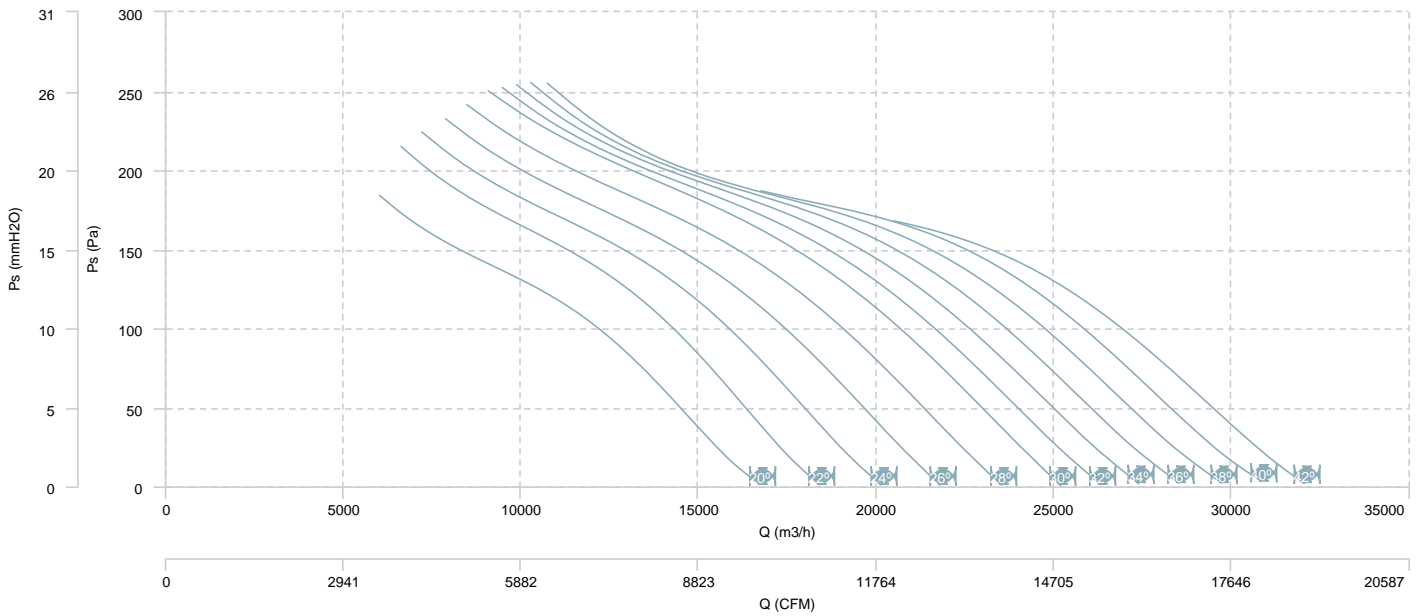

AIR FLOW - MECHANICAL POWER (6 poles)

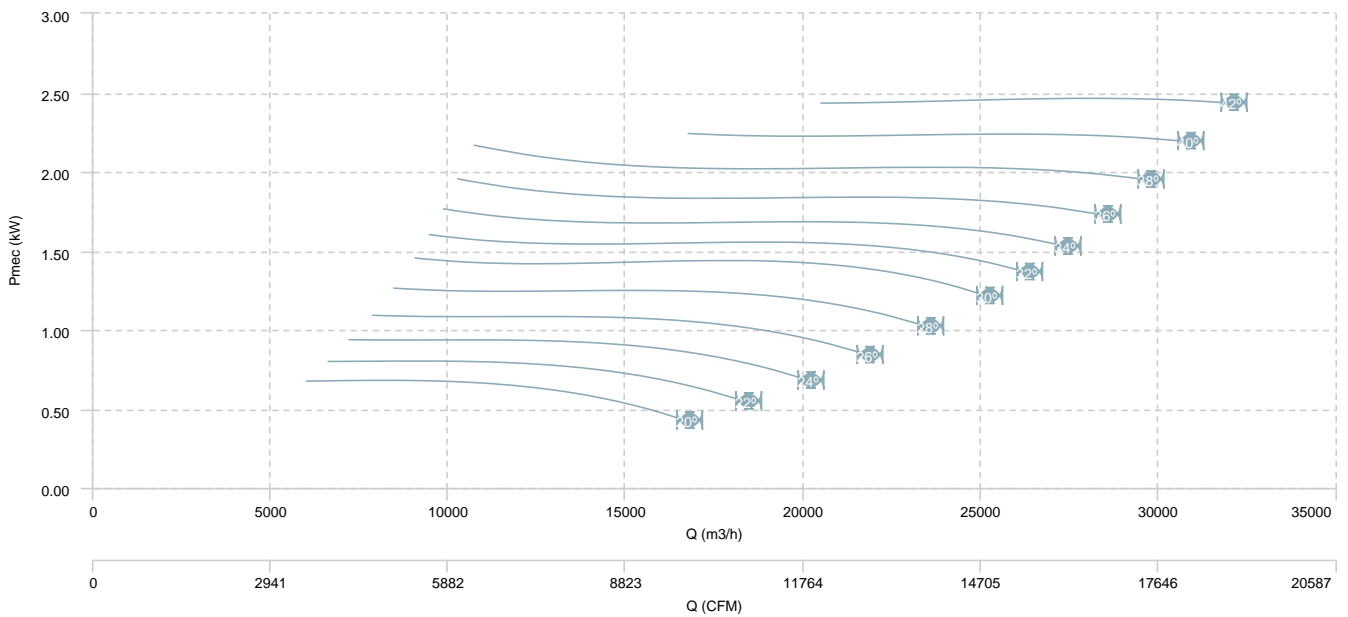



HMXF 90 T4/T8 (A3:4) F400

AIR FLOW - PRESSURE (4 poles)

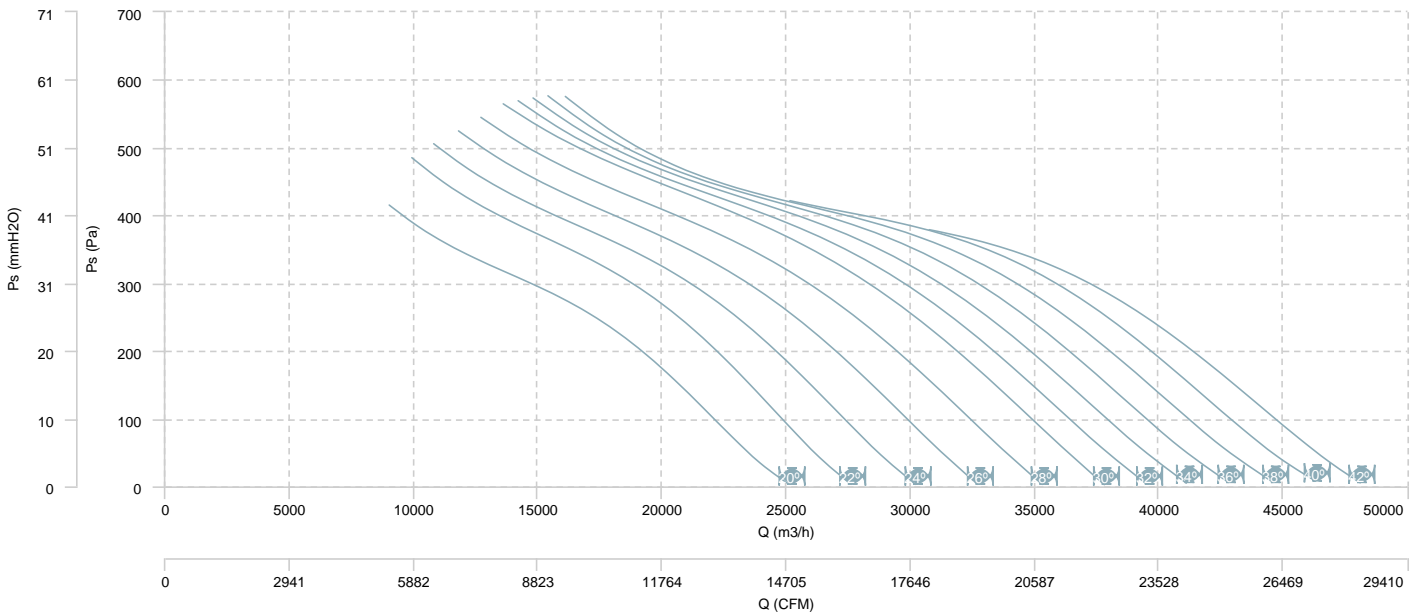

AIR FLOW - MECHANICAL POWER (4 poles)

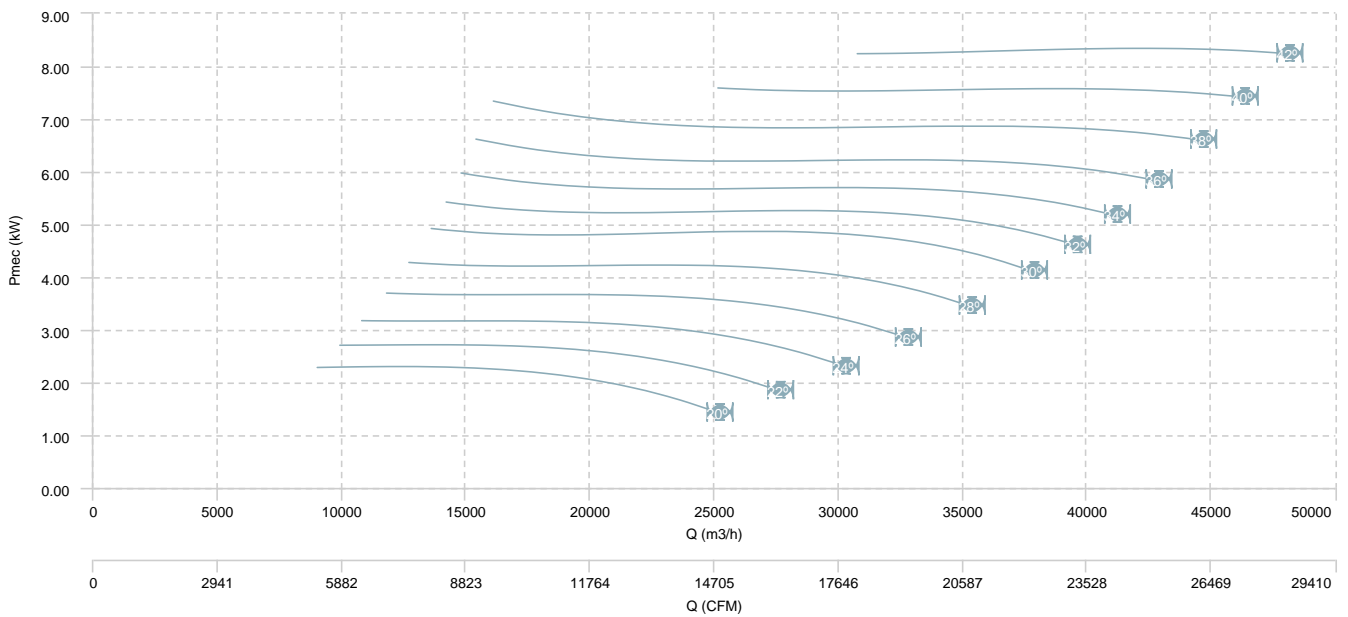

HMXF 90 T4/T8 (A3:4) F400

AIR FLOW - PRESSURE (8 poles)

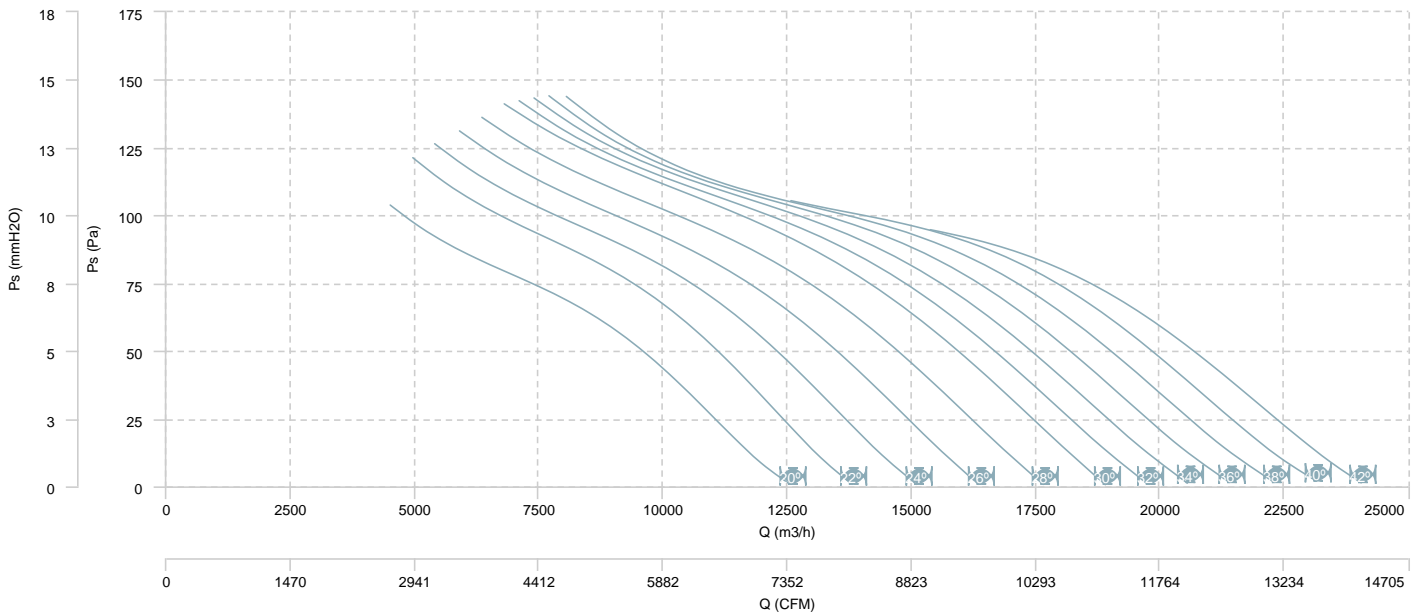

AIR FLOW - MECHANICAL POWER (8 poles)

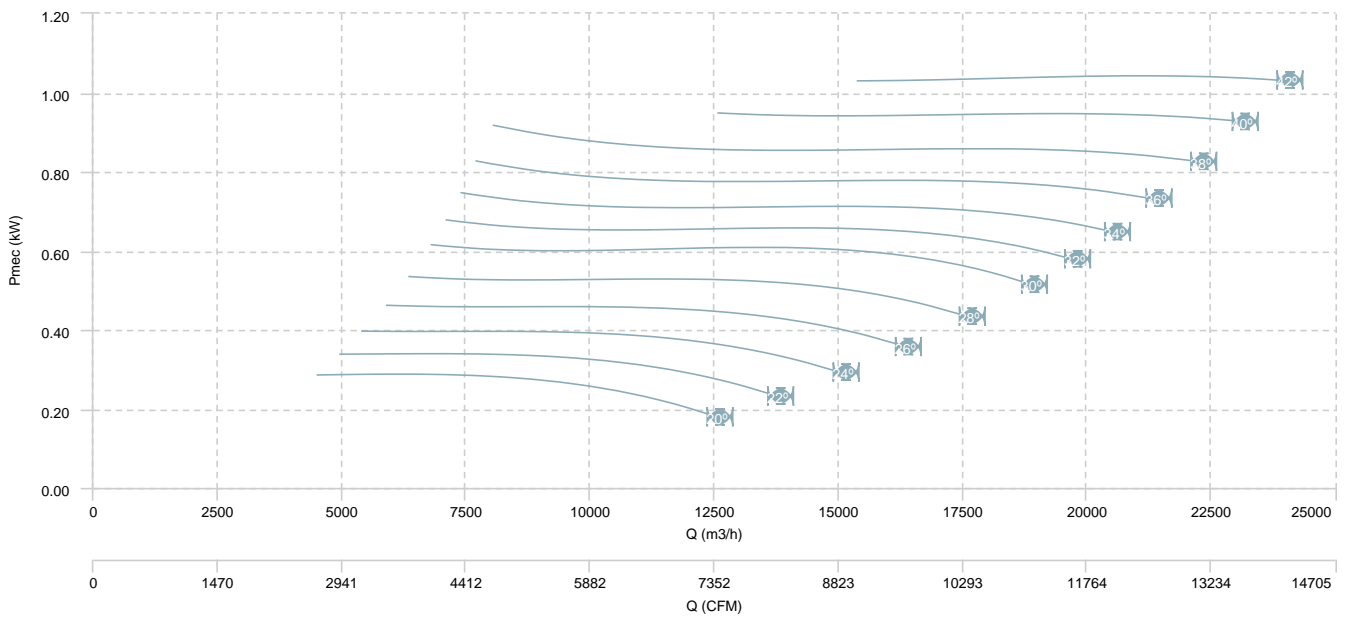

HMXF 90 T4/T8 (A3:8) F400

AIR FLOW - PRESSURE (4 poles)

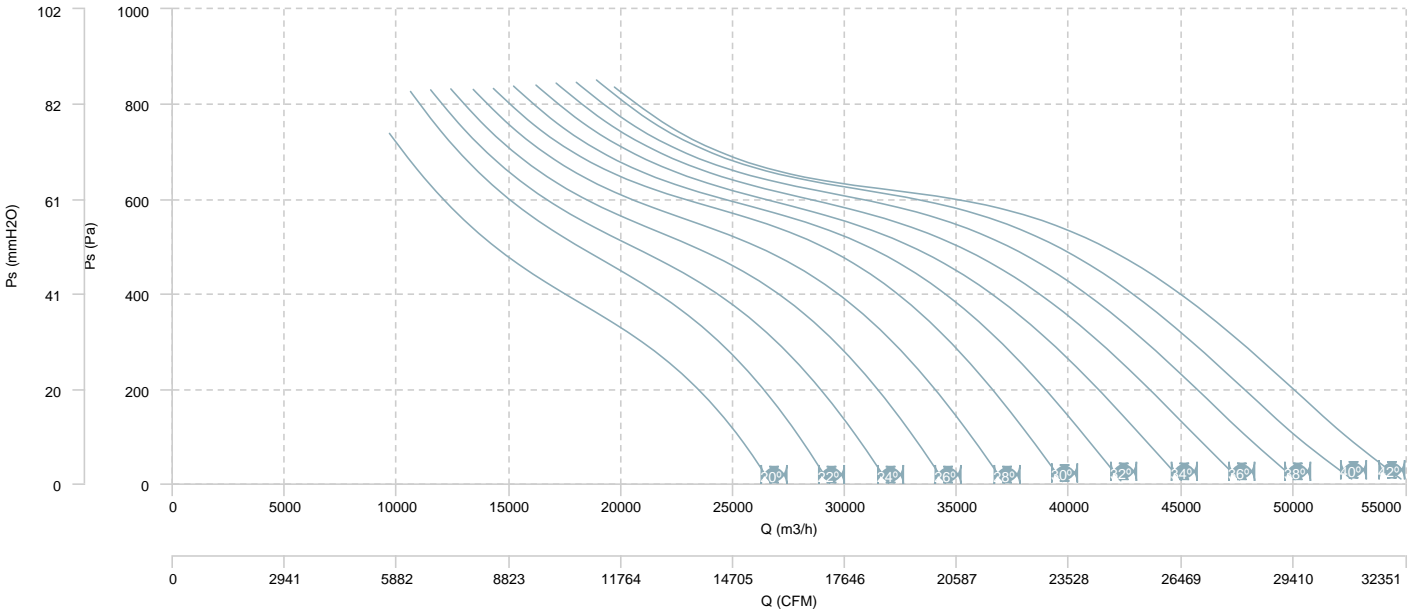

AIR FLOW - MECHANICAL POWER (4 poles)

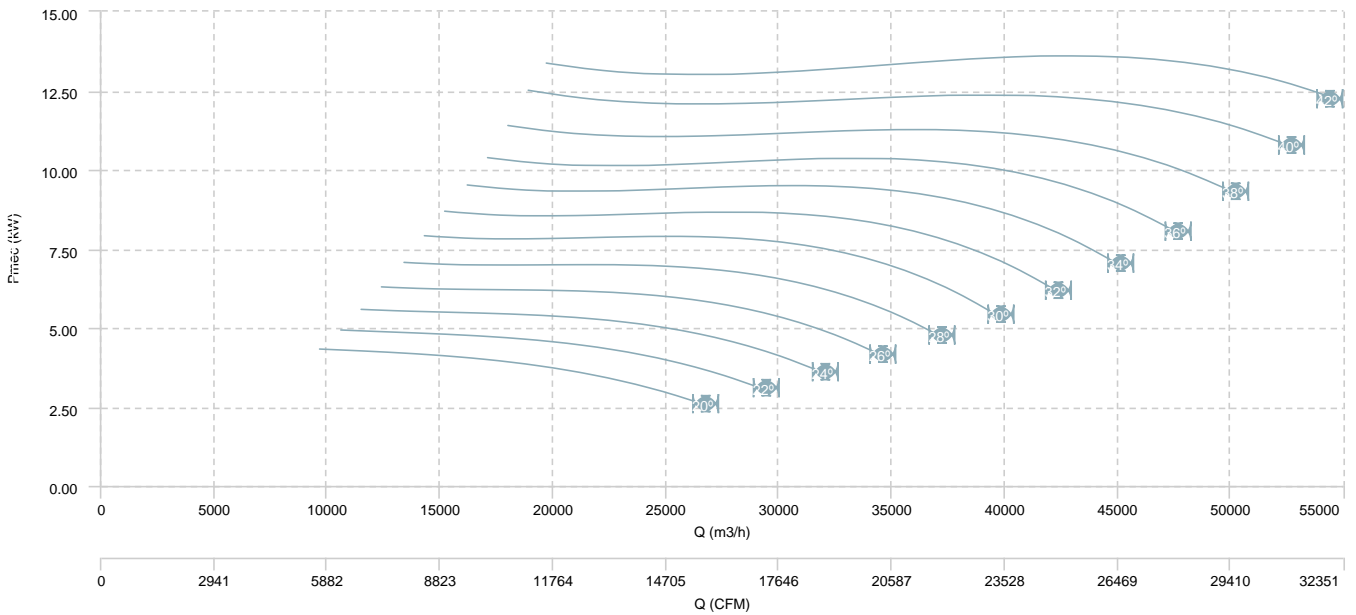

HMXF 90 T4/T8 (A3:8) F400

AIR FLOW - PRESSURE (8 poles)

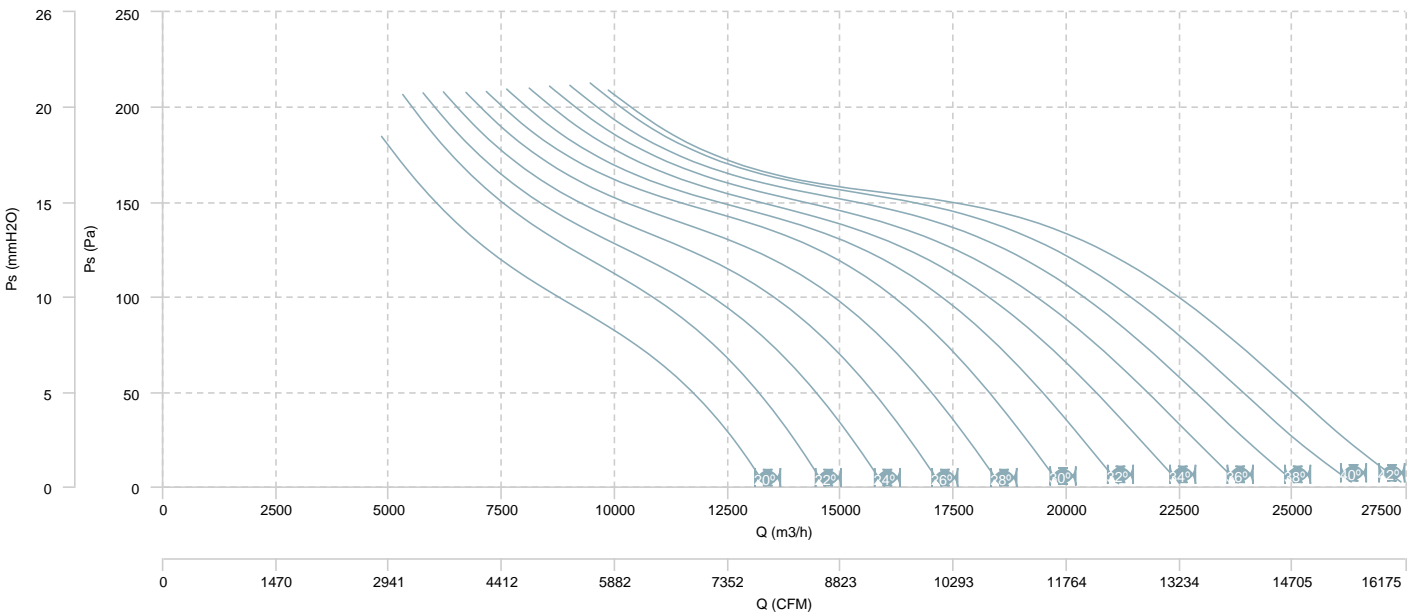

AIR FLOW - MECHANICAL POWER (8 poles)

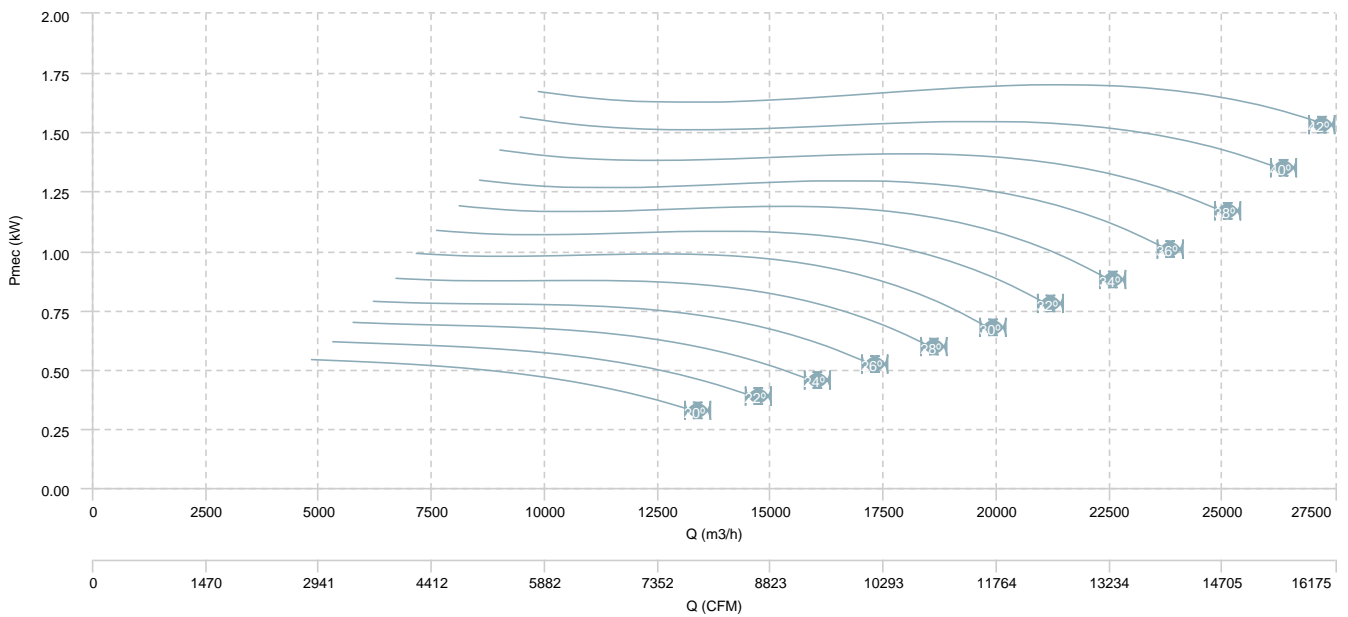

HMFx 100 T4 (A3:4) F400

AIR FLOW - PRESSURE

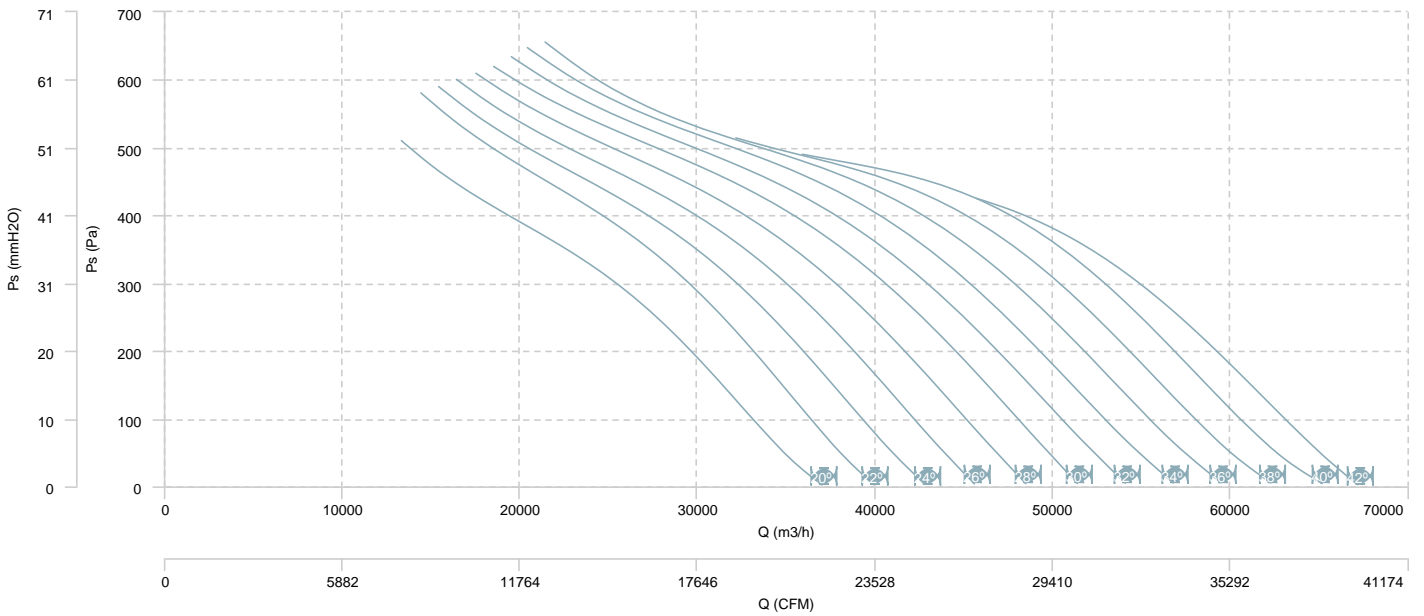

AIR FLOW - MECHANICAL POWER

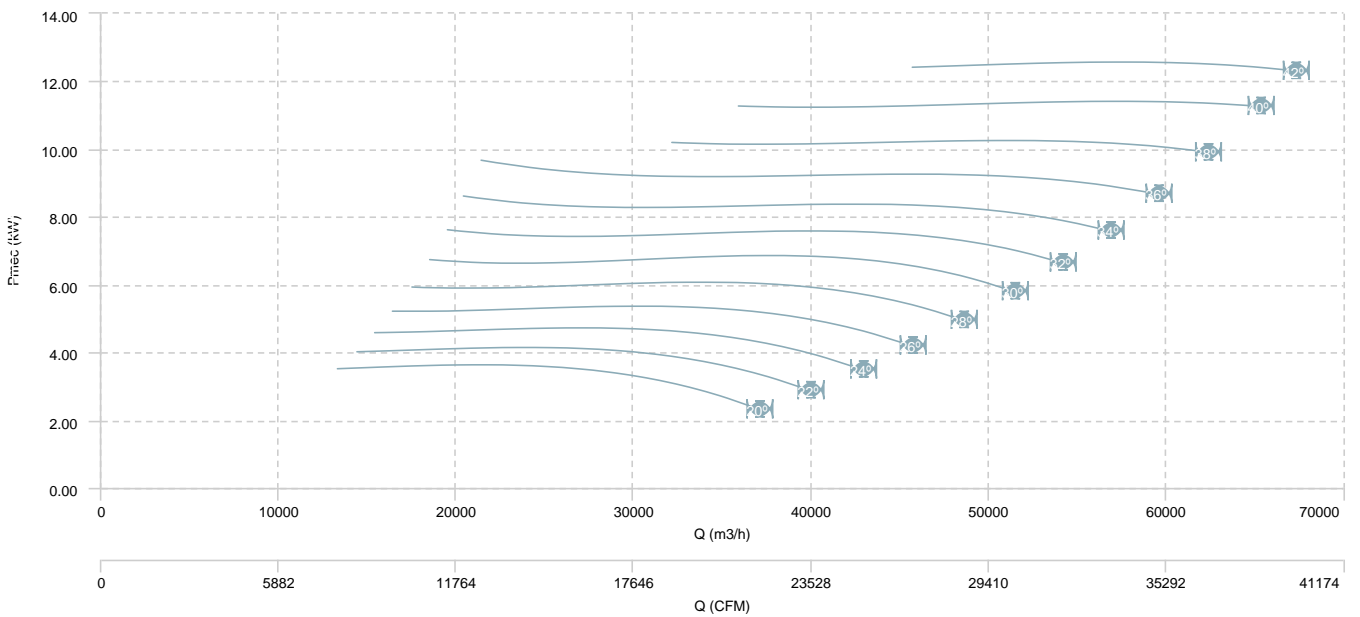

HMXF 100 T4 (A3:8) F400

AIR FLOW - PRESSURE

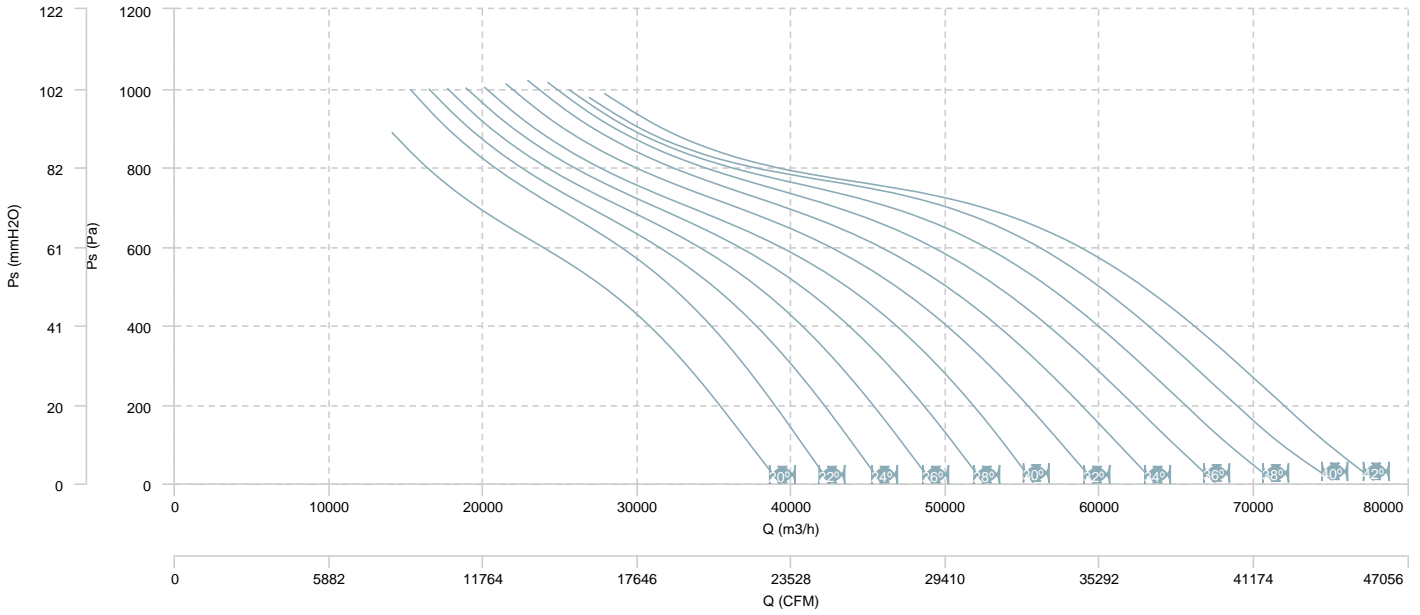

AIR FLOW - MECHANICAL POWER

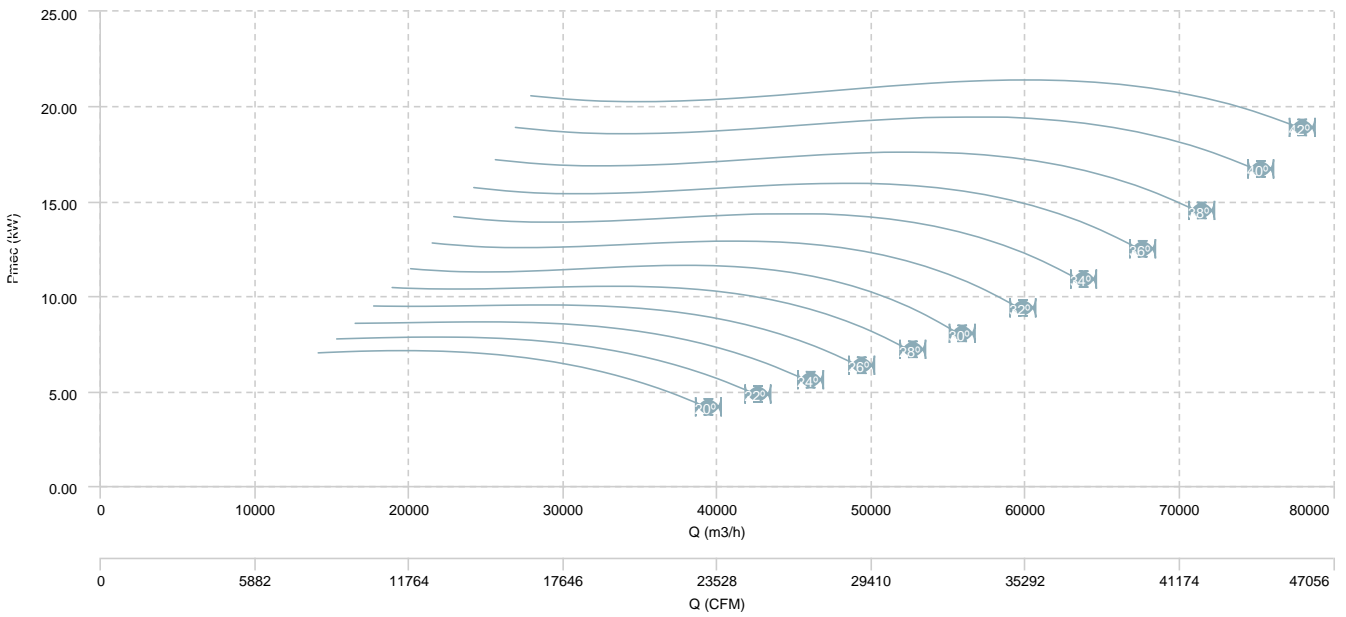

HMXF 100 T6 (A3:4) F400

AIR FLOW - PRESSURE

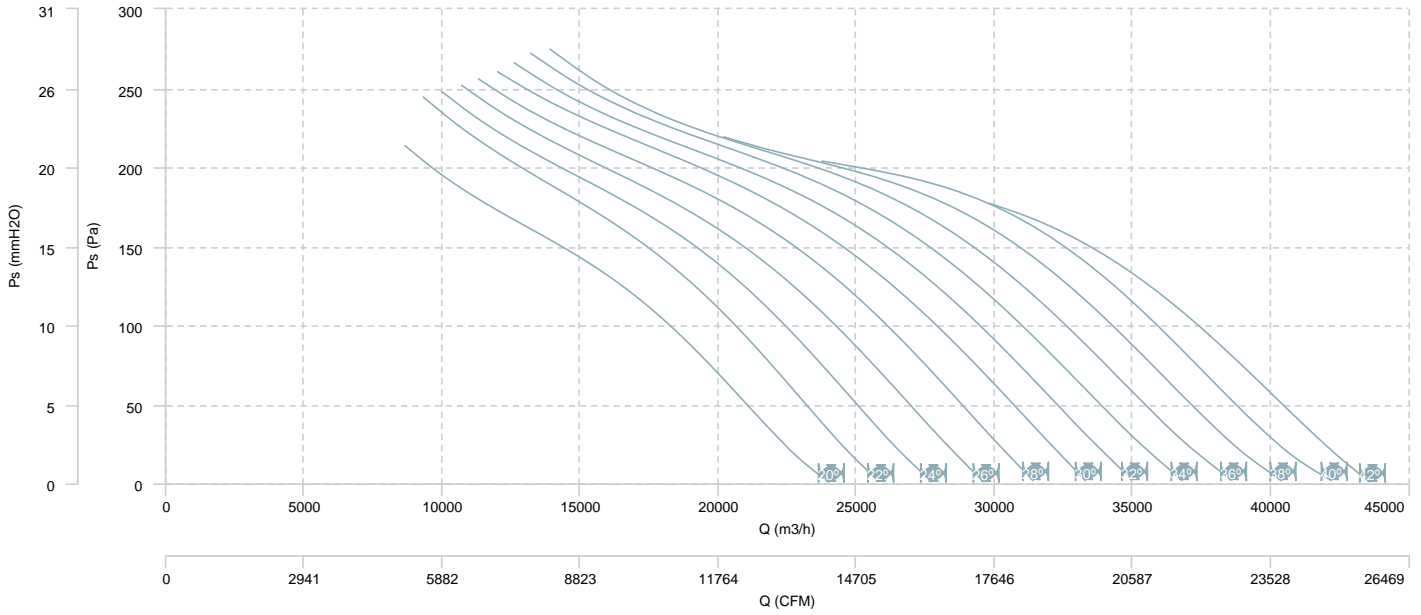

AIR FLOW - MECHANICAL POWER

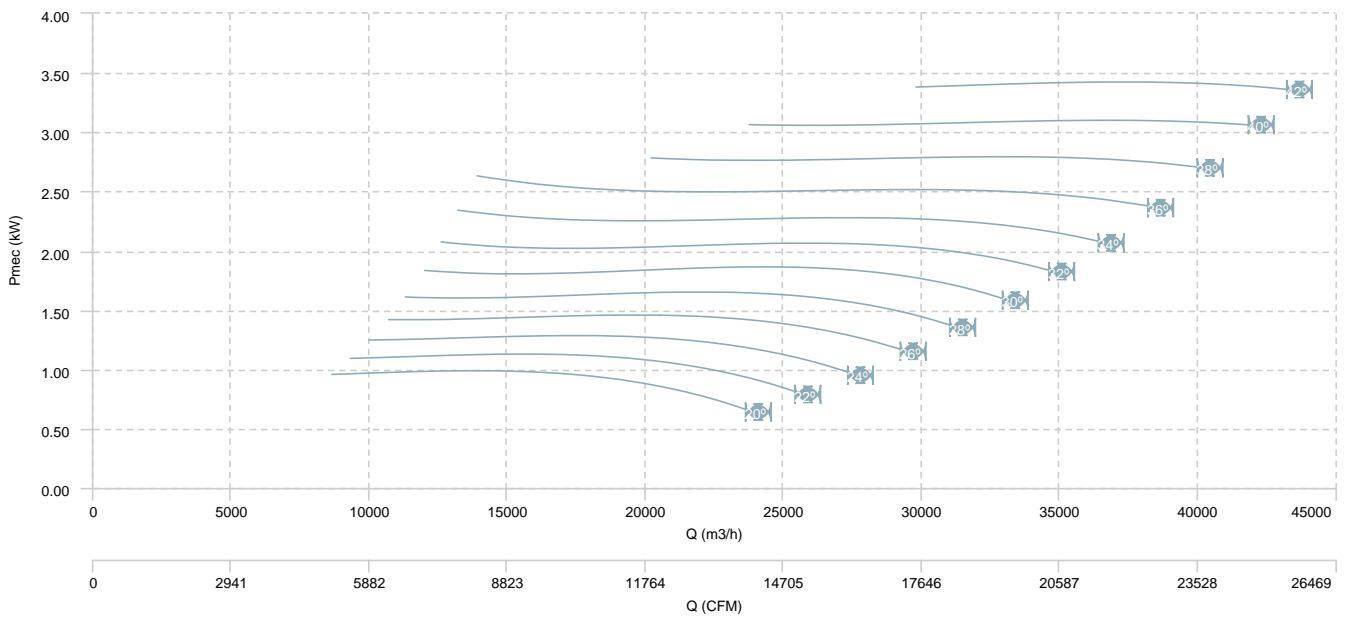

HMXF 100 T6 (A3:8) F400

AIR FLOW - PRESSURE

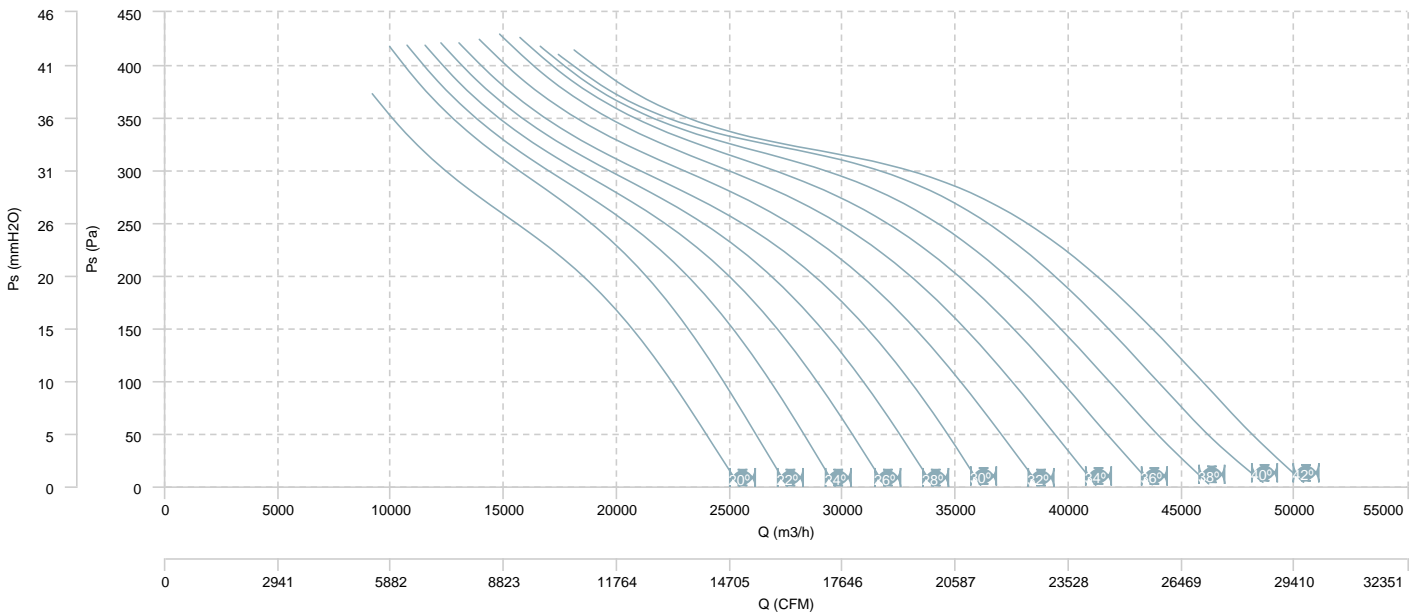

AIR FLOW - MECHANICAL POWER

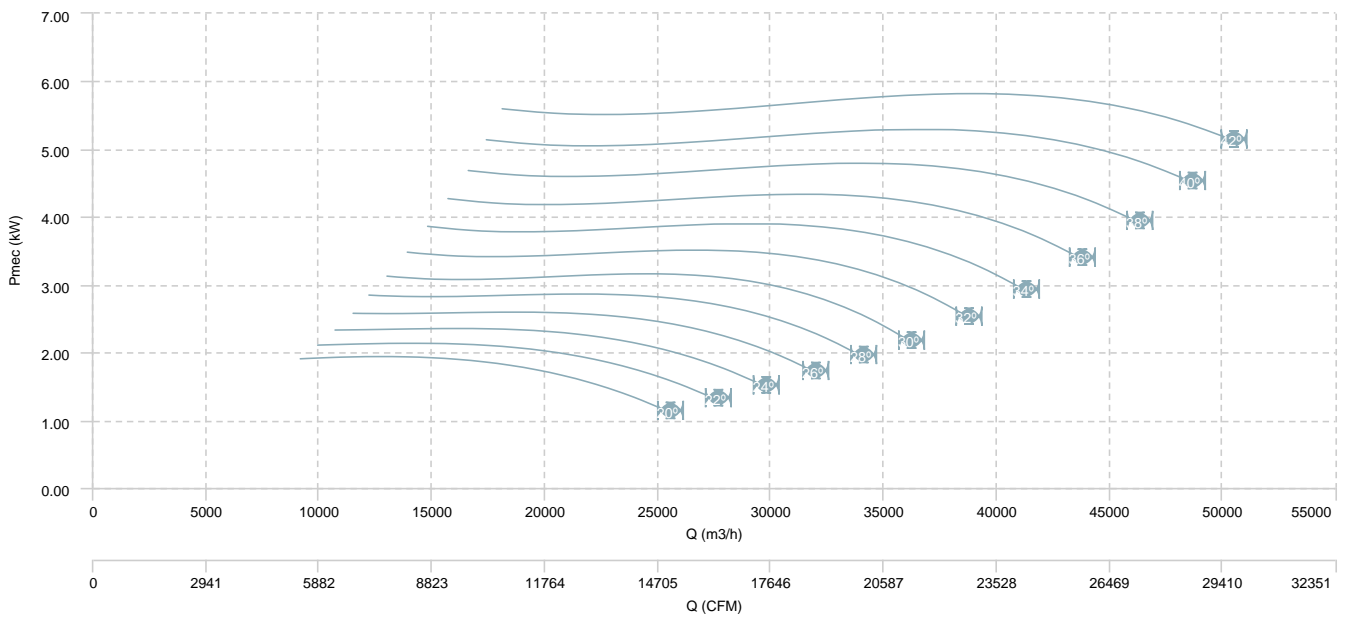



HMXF 100 T4/T6 (A3:4) F400

AIR FLOW - PRESSURE (4 poles)

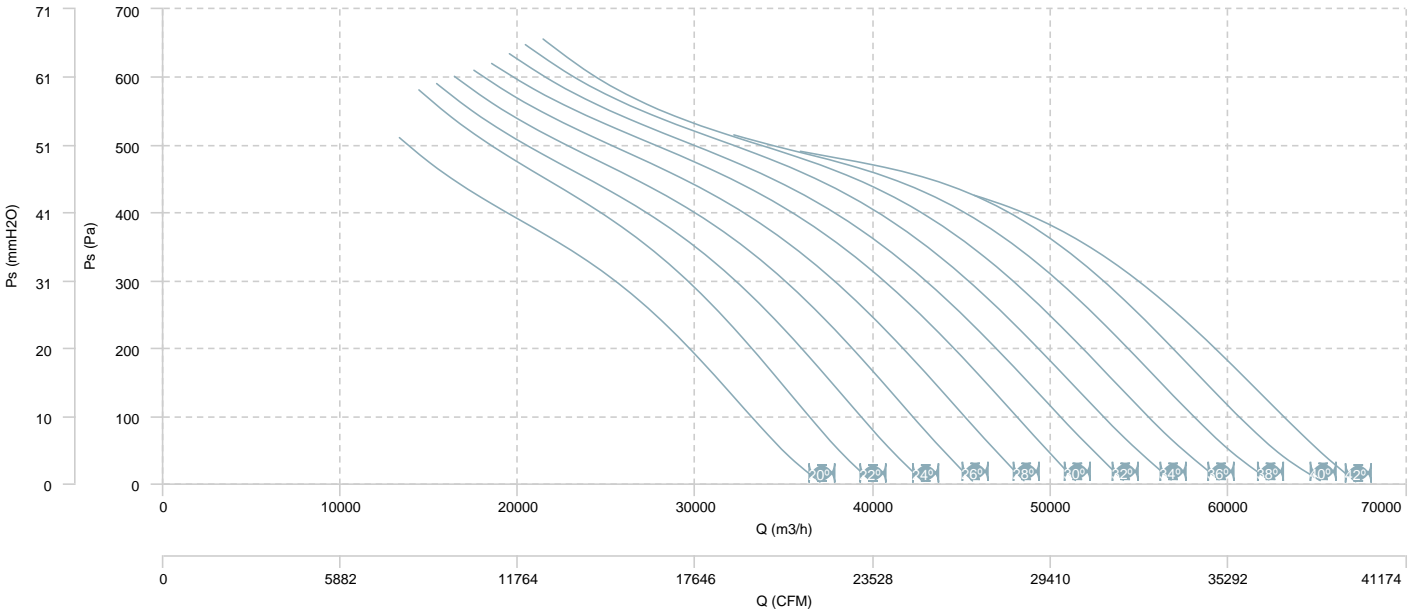

AIR FLOW - MECHANICAL POWER (4 poles)

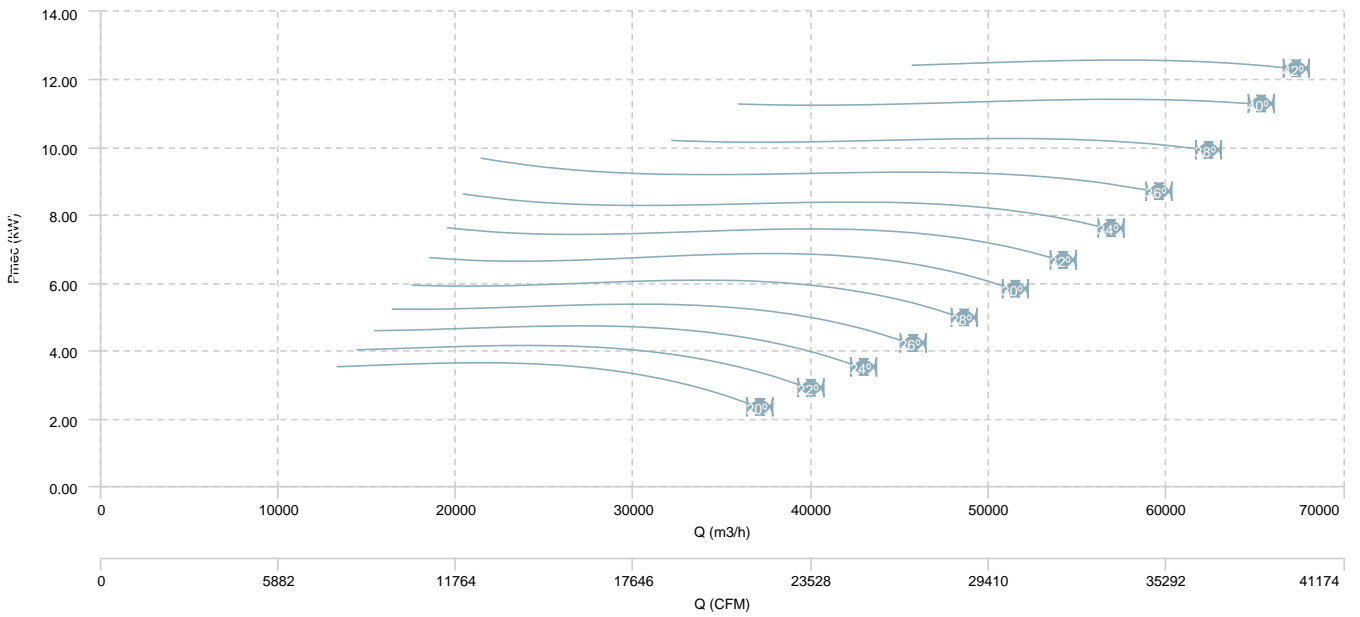

HMXF 100 T4/T6 (A3:4) F400

AIR FLOW - PRESSURE (6 poles)

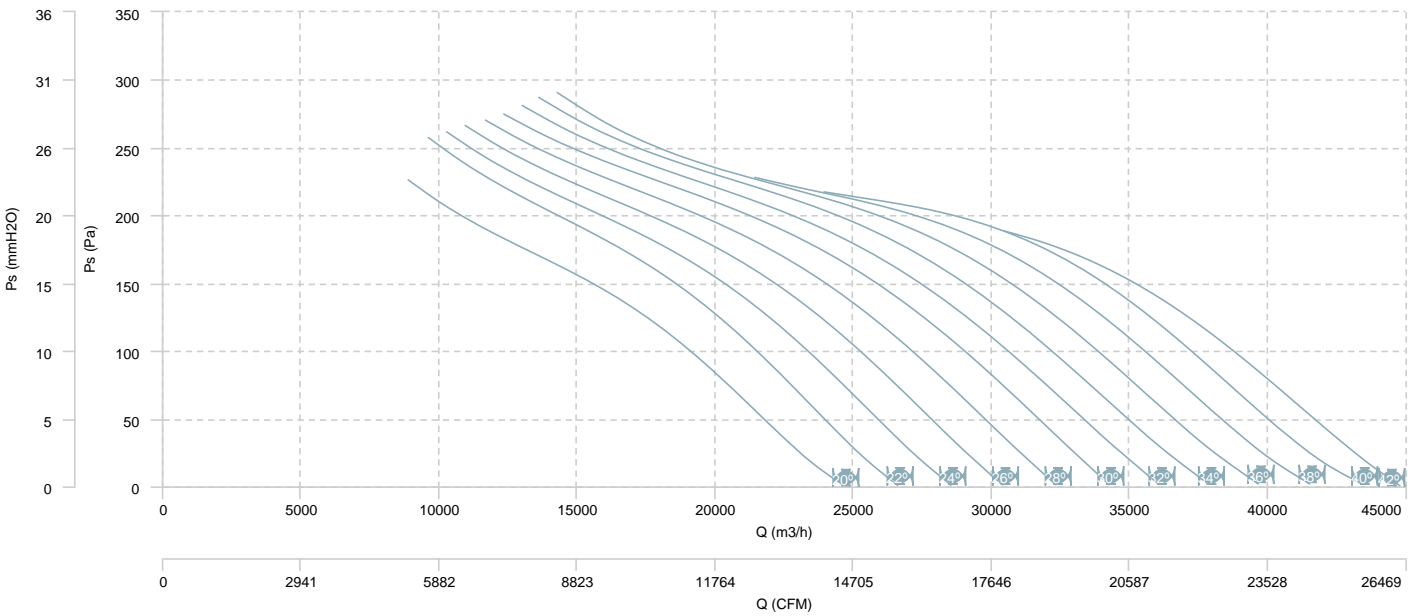

AIR FLOW - MECHANICAL POWER (6 poles)

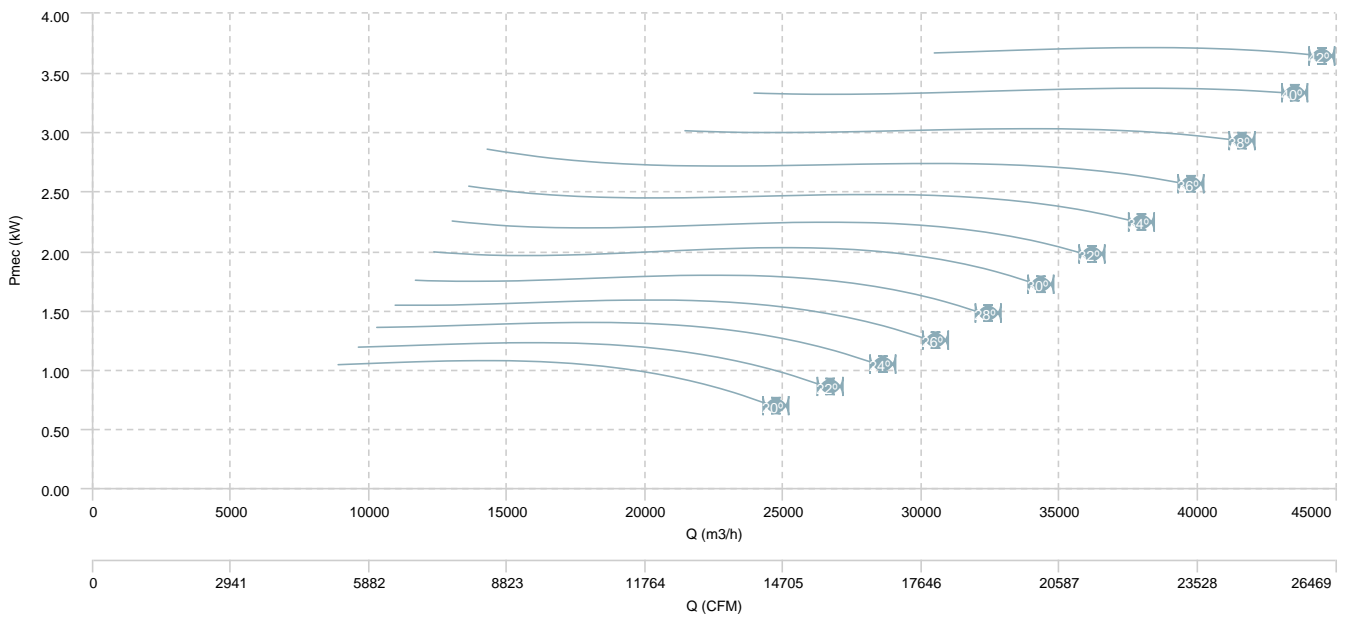

HMXF 100 T4/T6 (A3:8) F400

AIR FLOW - PRESSURE (4 poles)

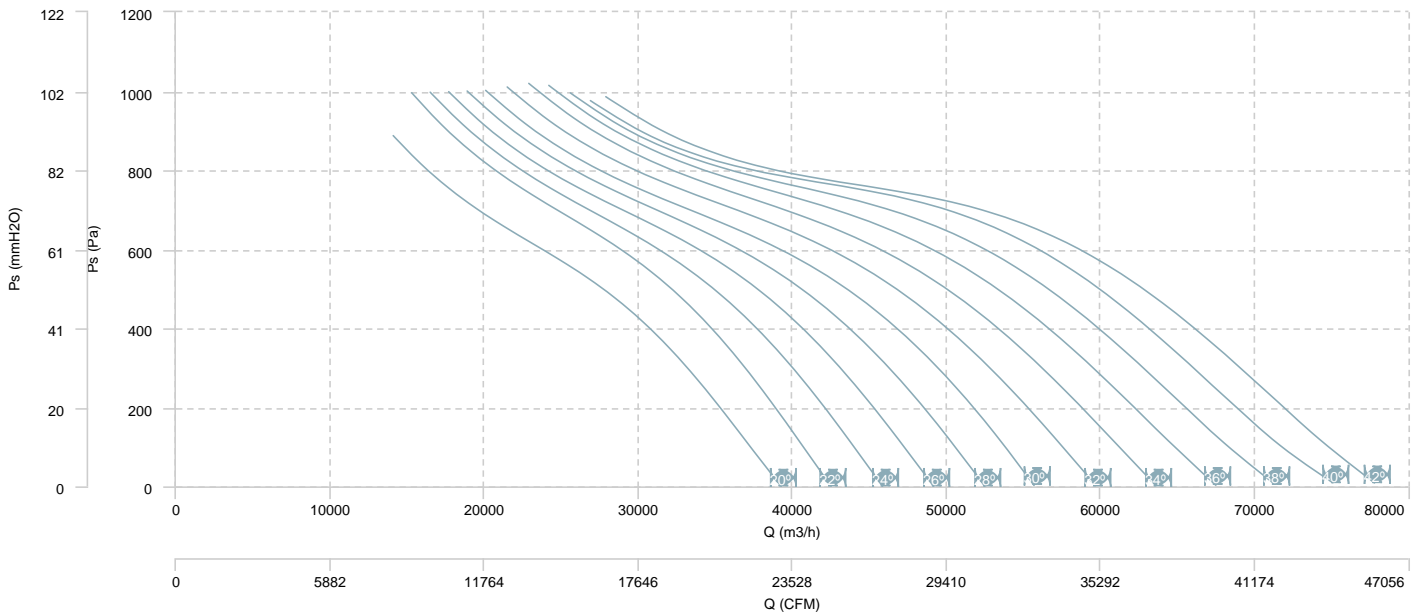

AIR FLOW - MECHANICAL POWER (4 poles)

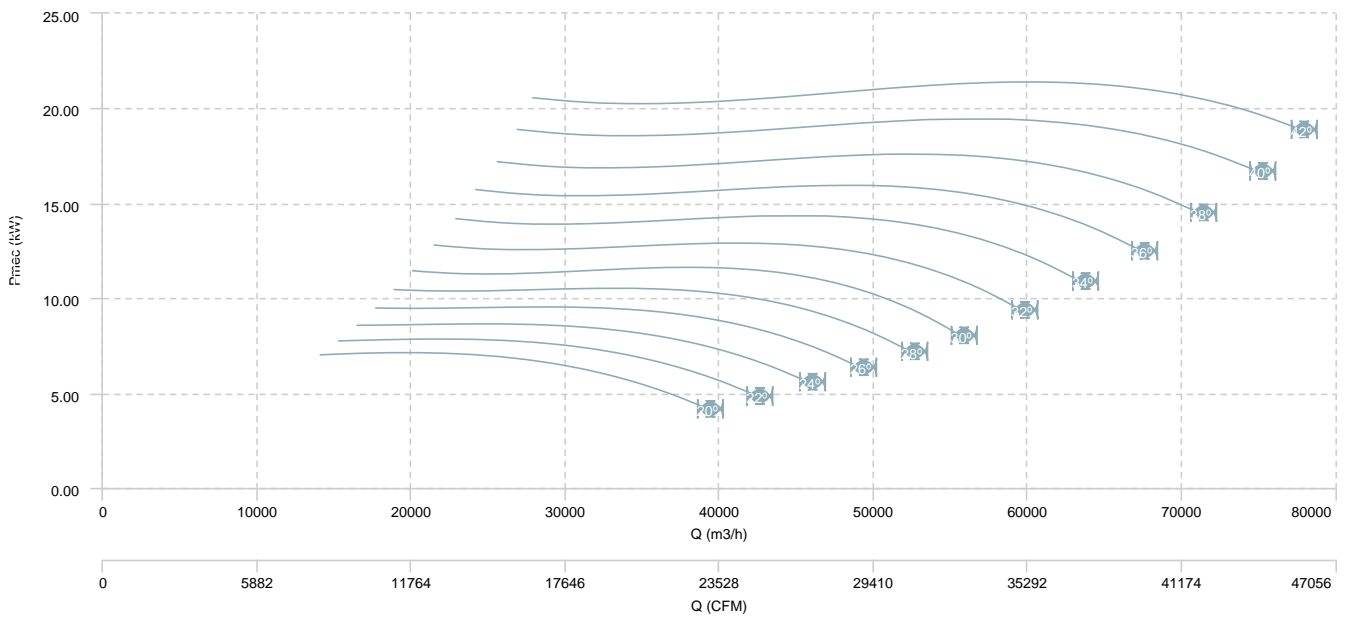

HMXF 100 T4/T6 (A3:8) F400

AIR FLOW - PRESSURE (6 poles)

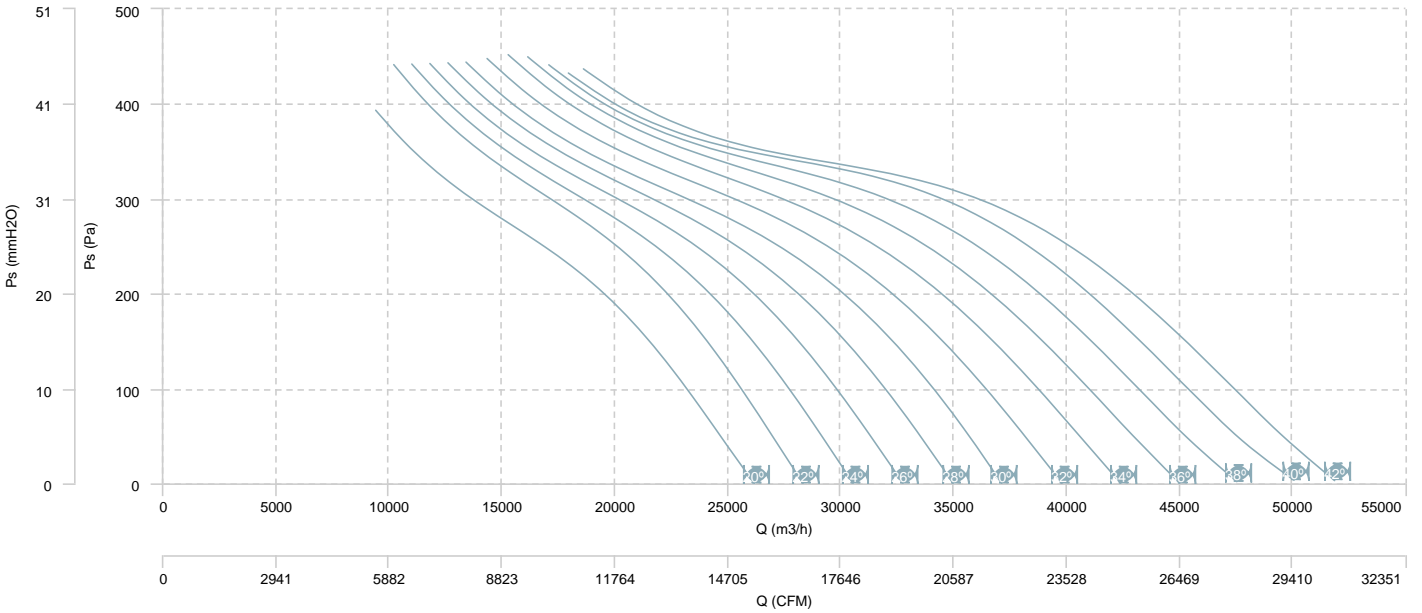

AIR FLOW - MECHANICAL POWER (6 poles)

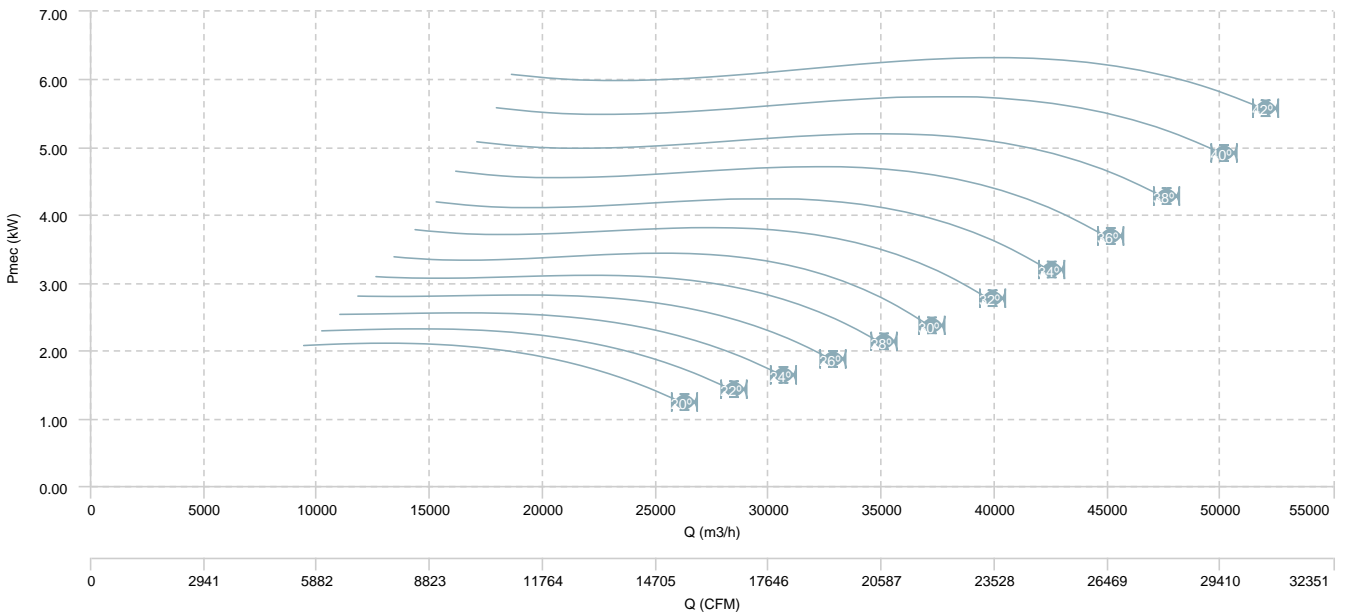

HMXF 100 T4/T8 (A3:4) F400

AIR FLOW - PRESSURE (4 poles)

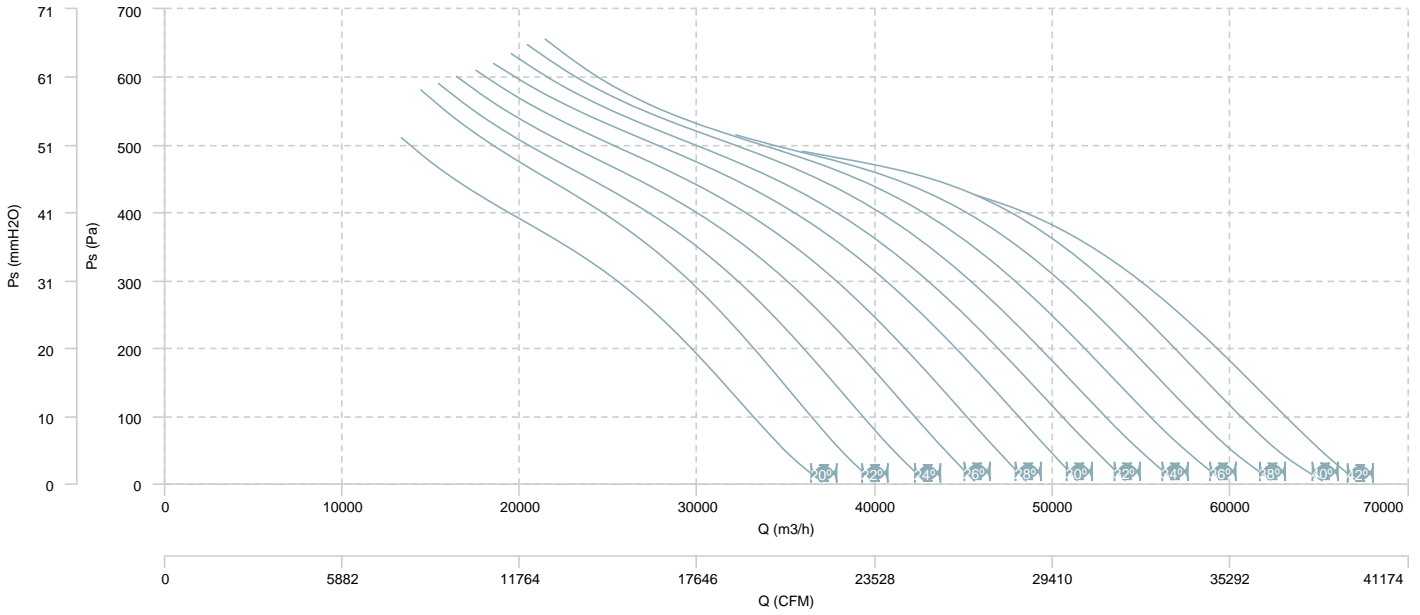

AIR FLOW - MECHANICAL POWER (4 poles)

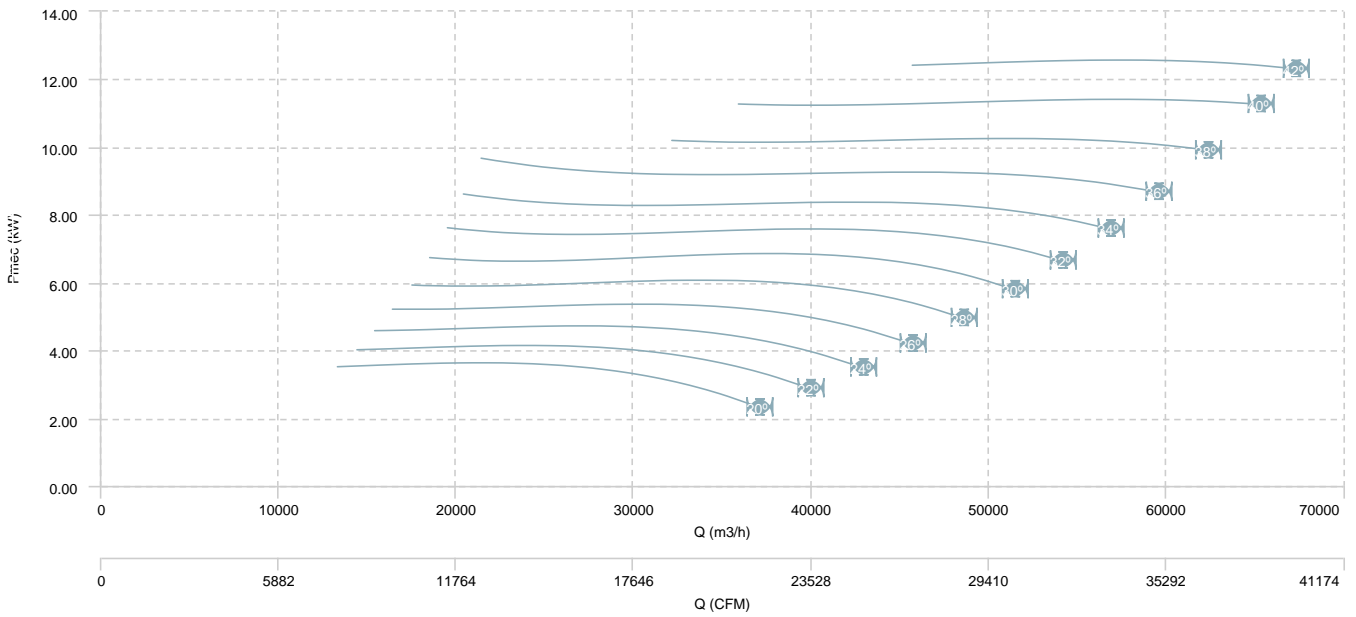

HMXF 100 T4/T8 (A3:4) F400

AIR FLOW - PRESSURE (8 poles)

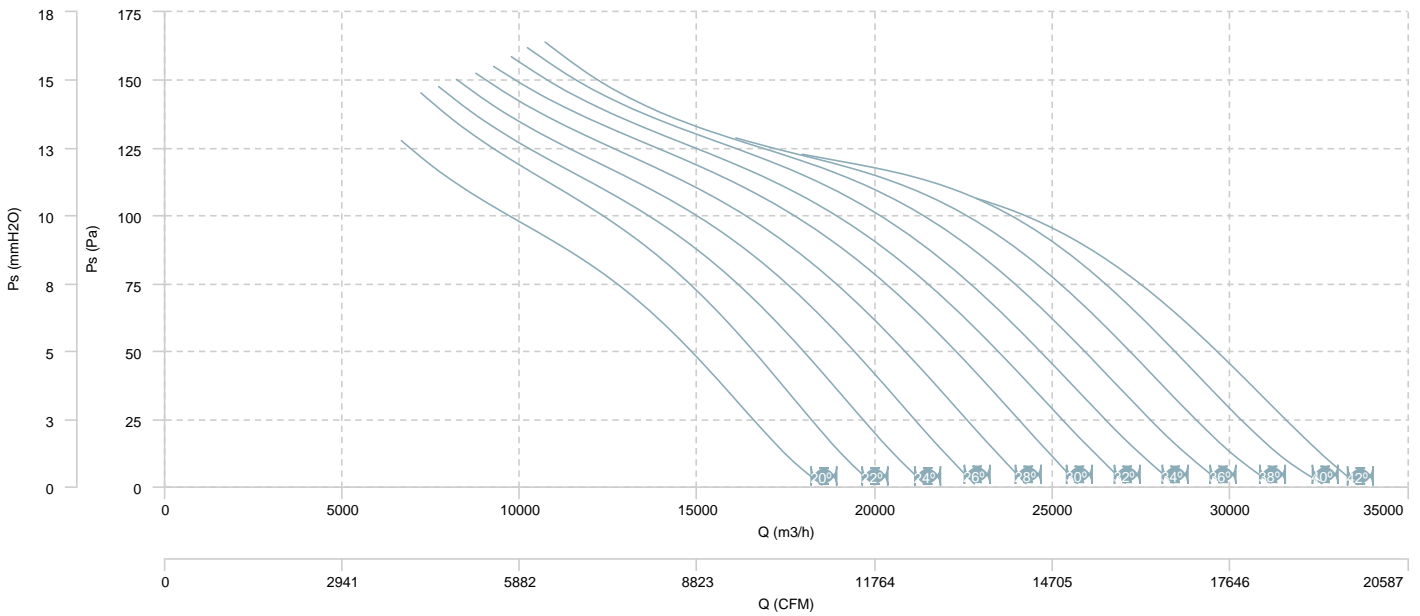

AIR FLOW - MECHANICAL POWER (8 poles)

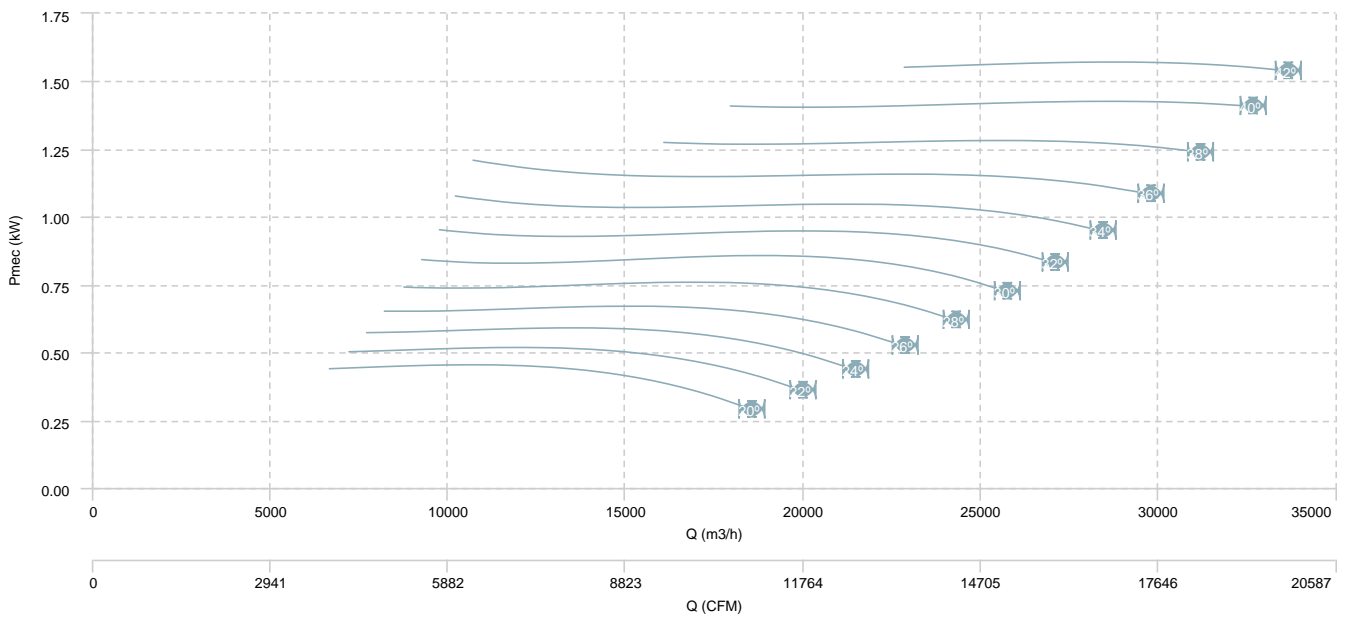

HMXF 100 T4/T8 (A3:8) F400

AIR FLOW - PRESSURE (4 poles)

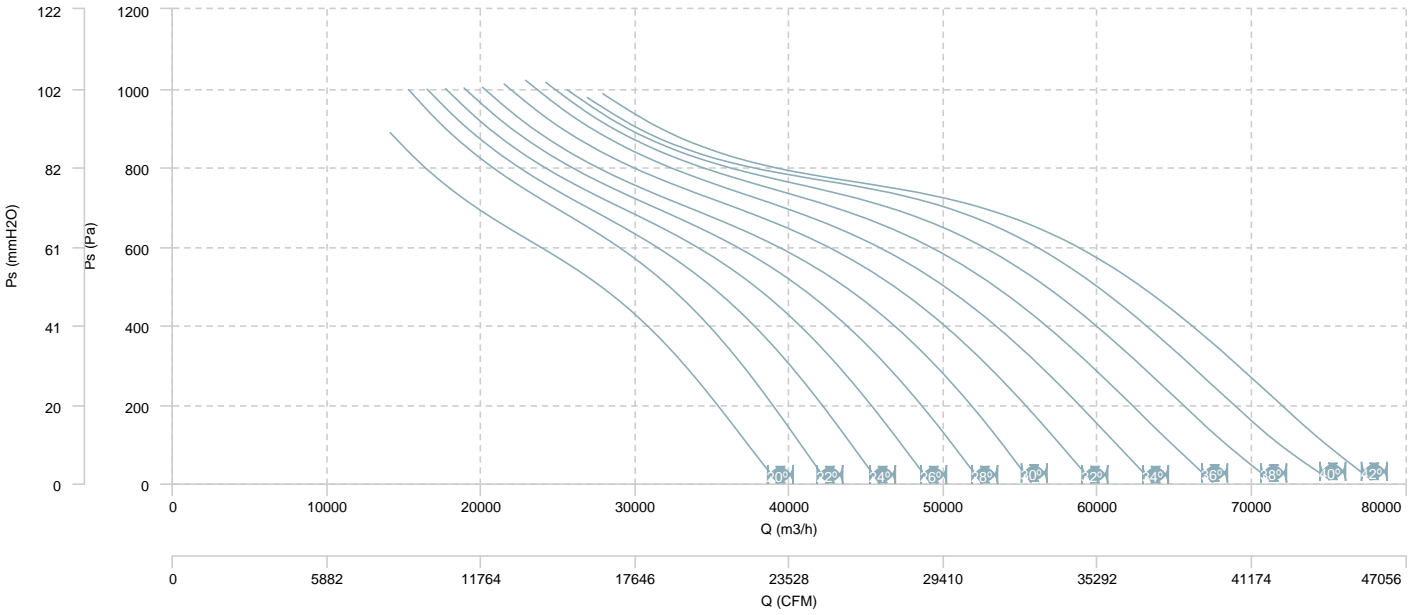

AIR FLOW - MECHANICAL POWER (4 poles)

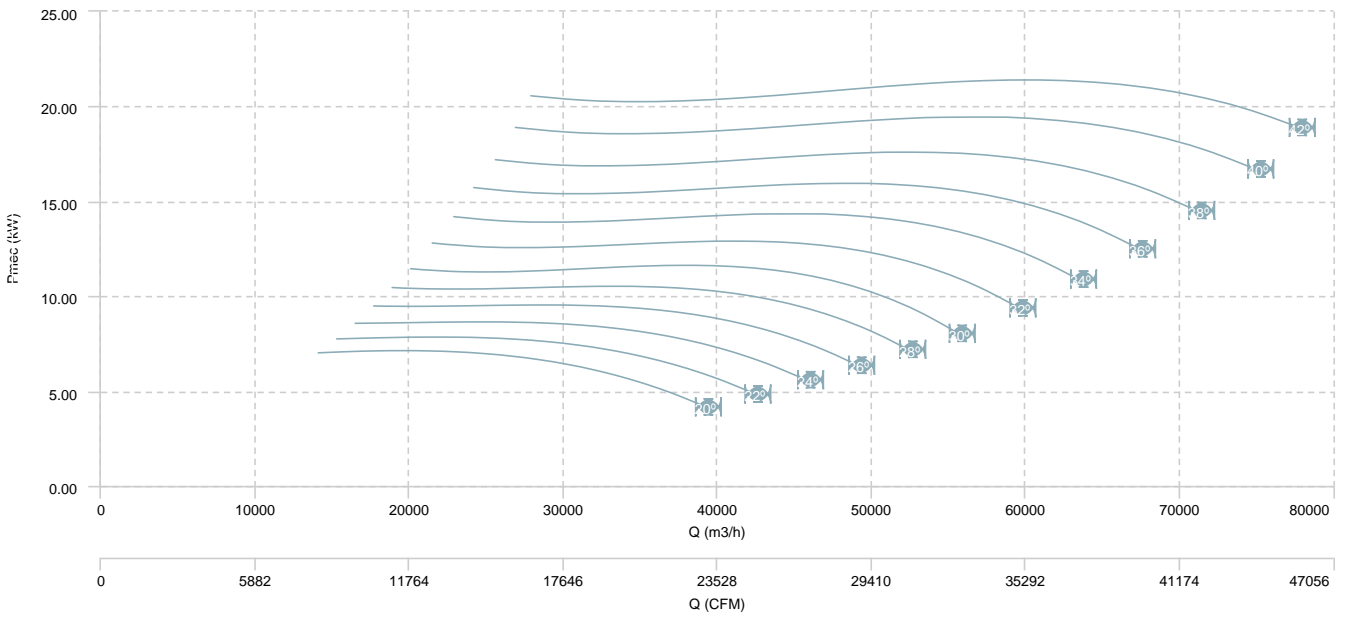

HMXF 100 T4/T8 (A3:8) F400

AIR FLOW - PRESSURE (8 poles)

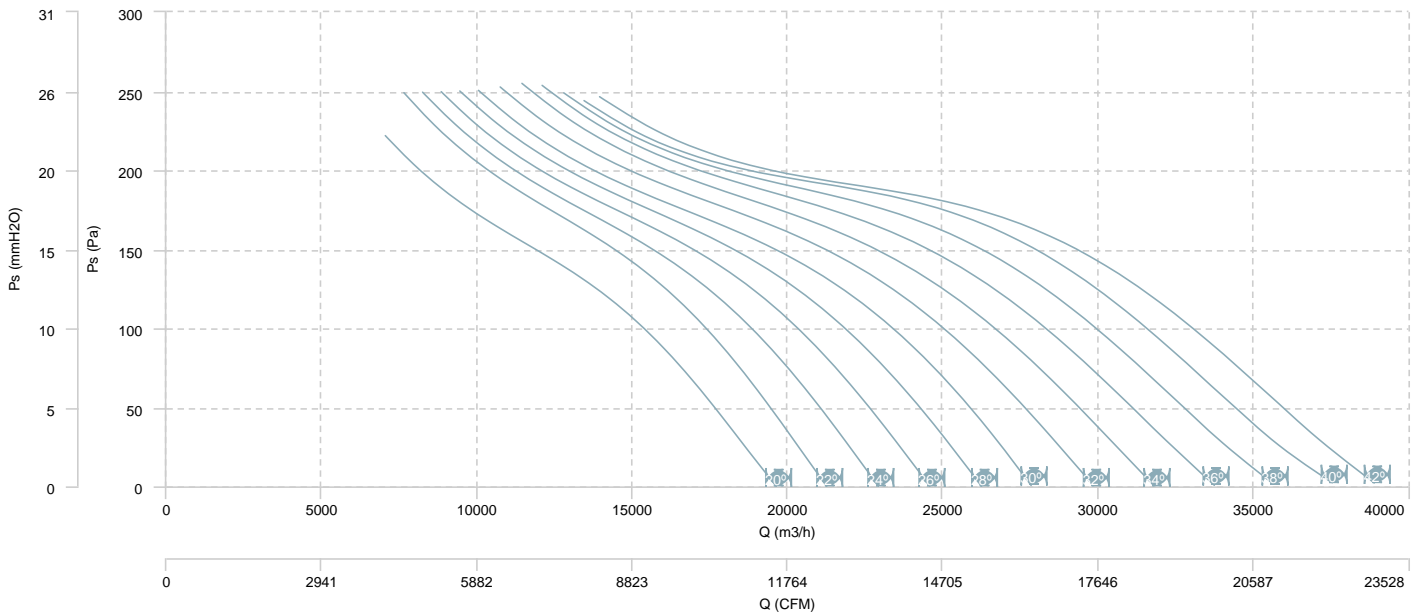

AIR FLOW - MECHANICAL POWER (8 poles)

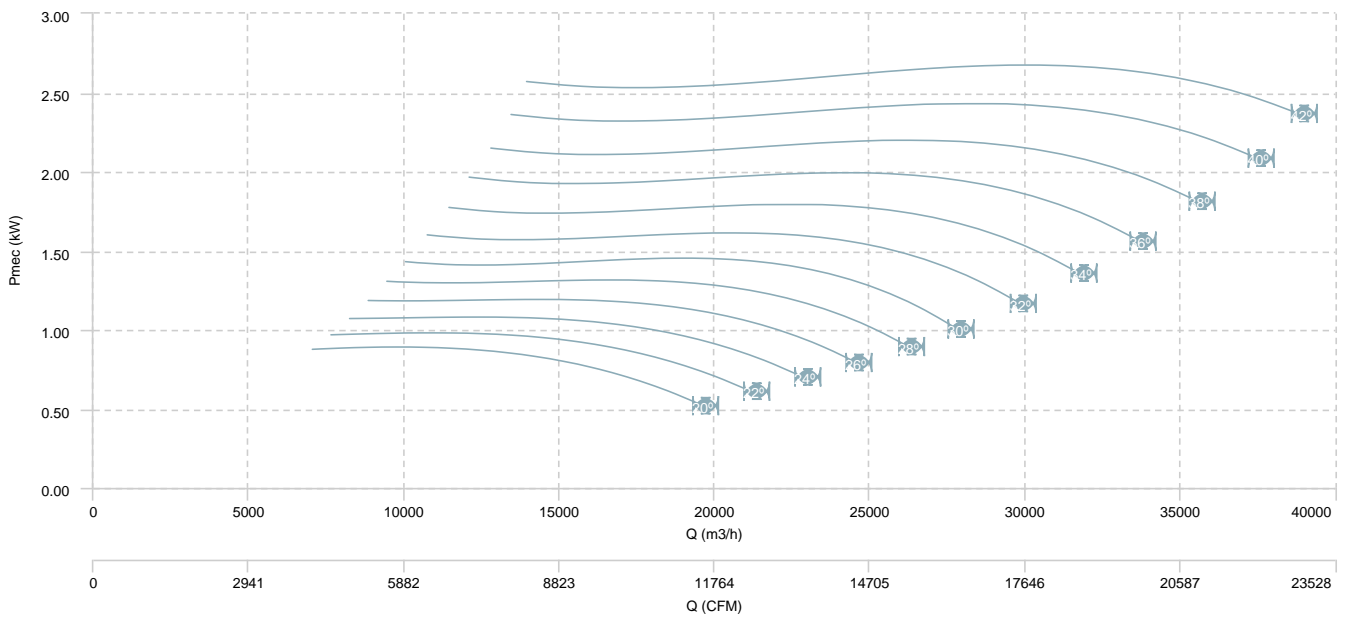



HMXF 112 T4 (A3:4) F400

AIR FLOW - PRESSURE

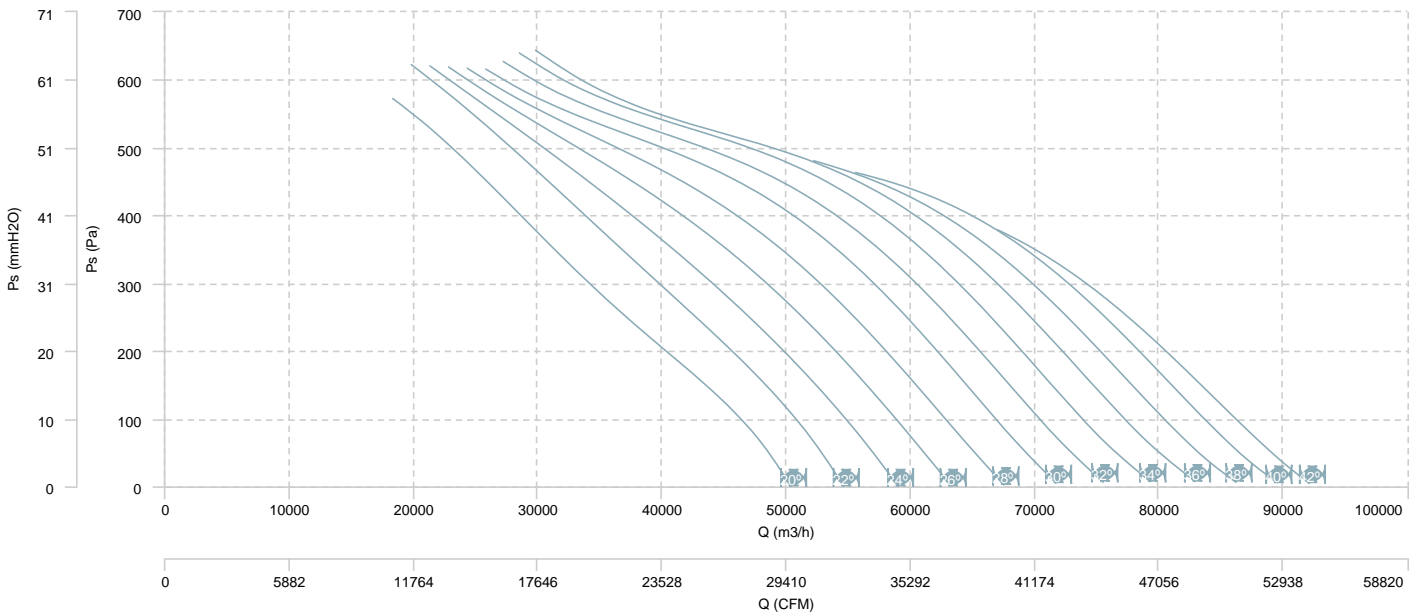

AIR FLOW - MECHANICAL POWER

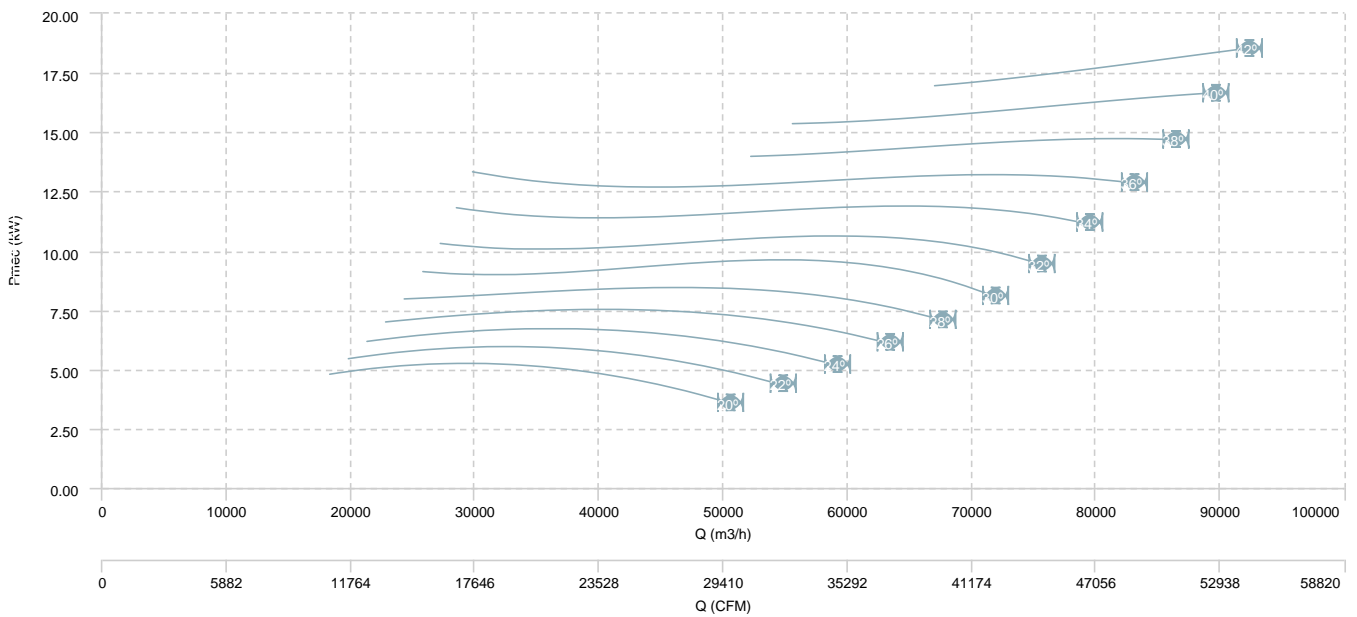

HMXF 112 T4 (A3:8) F400

AIR FLOW - PRESSURE

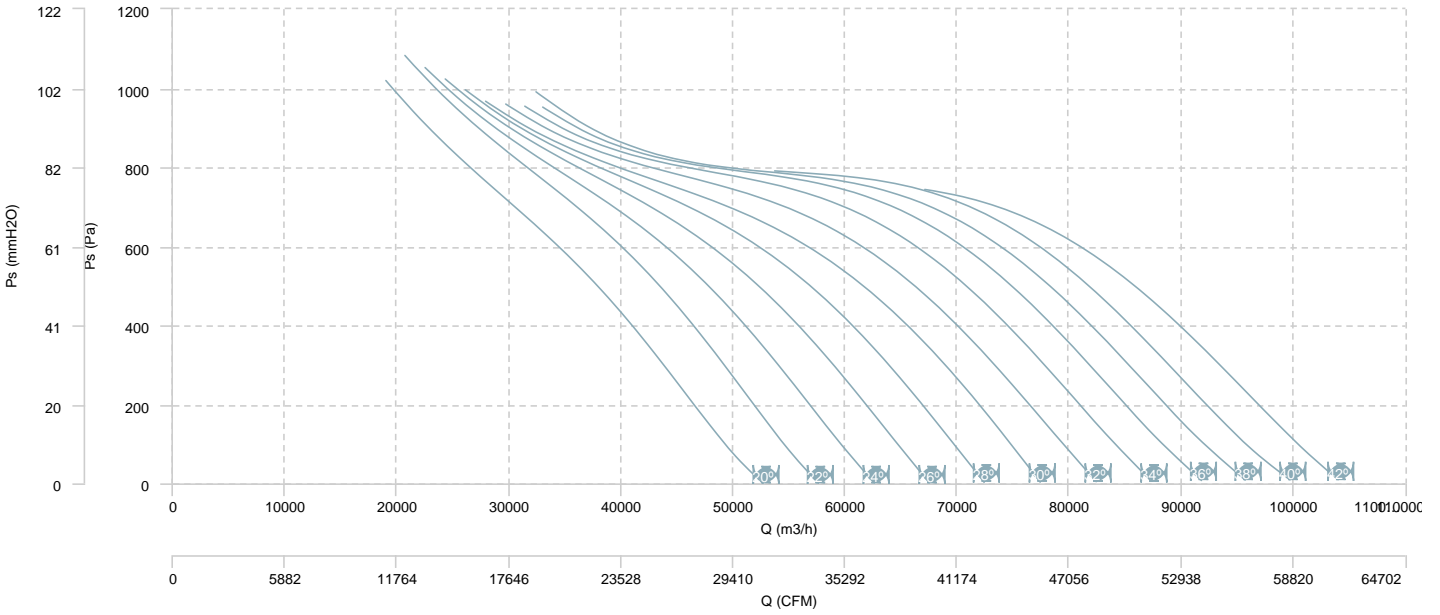

AIR FLOW - MECHANICAL POWER

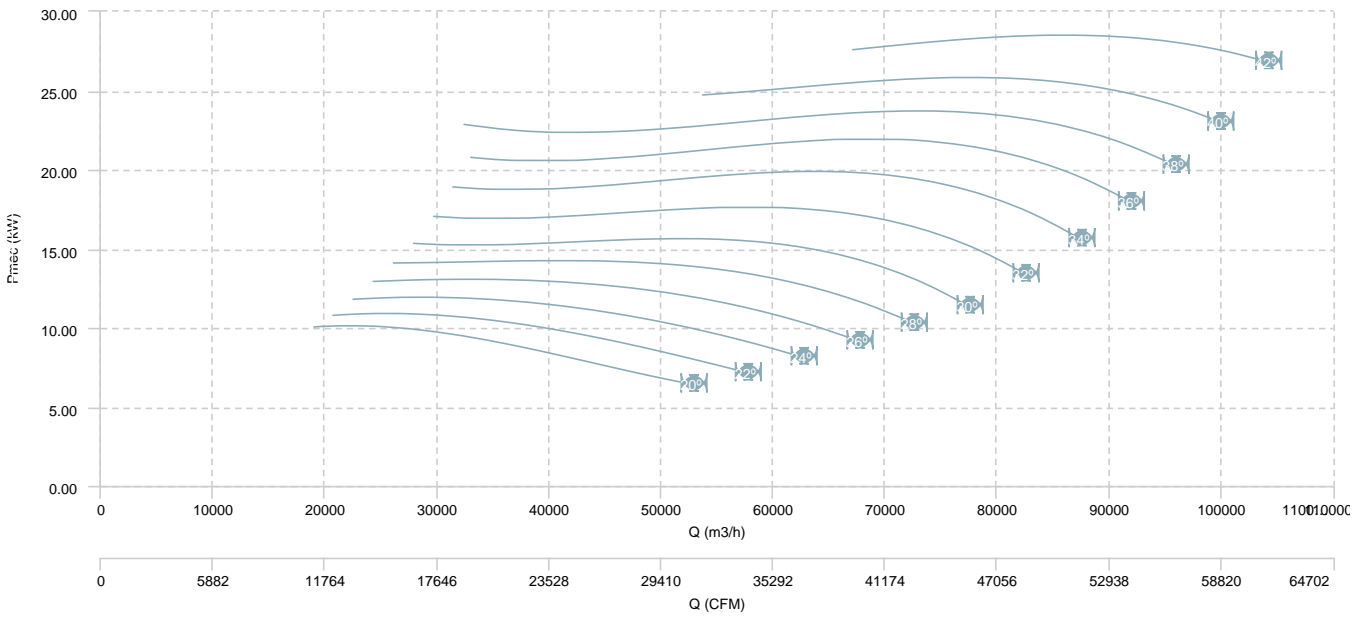

HMXF 112 T6 (A3:4) F400

AIR FLOW - PRESSURE

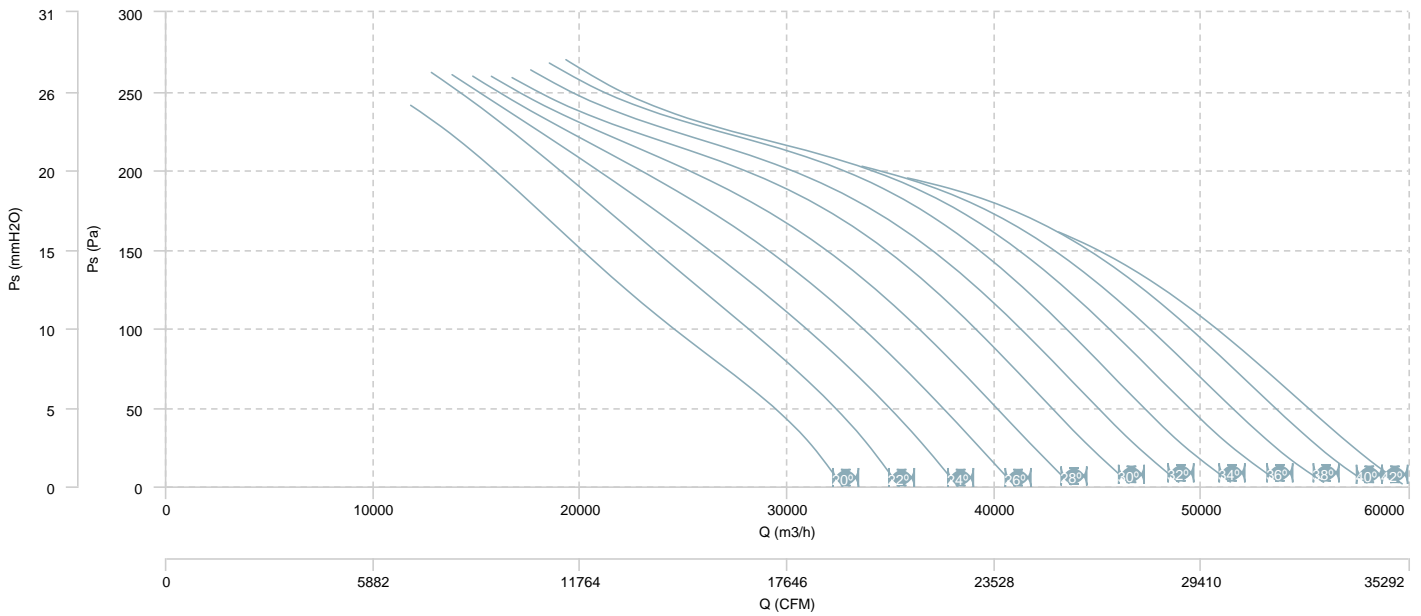

AIR FLOW - MECHANICAL POWER

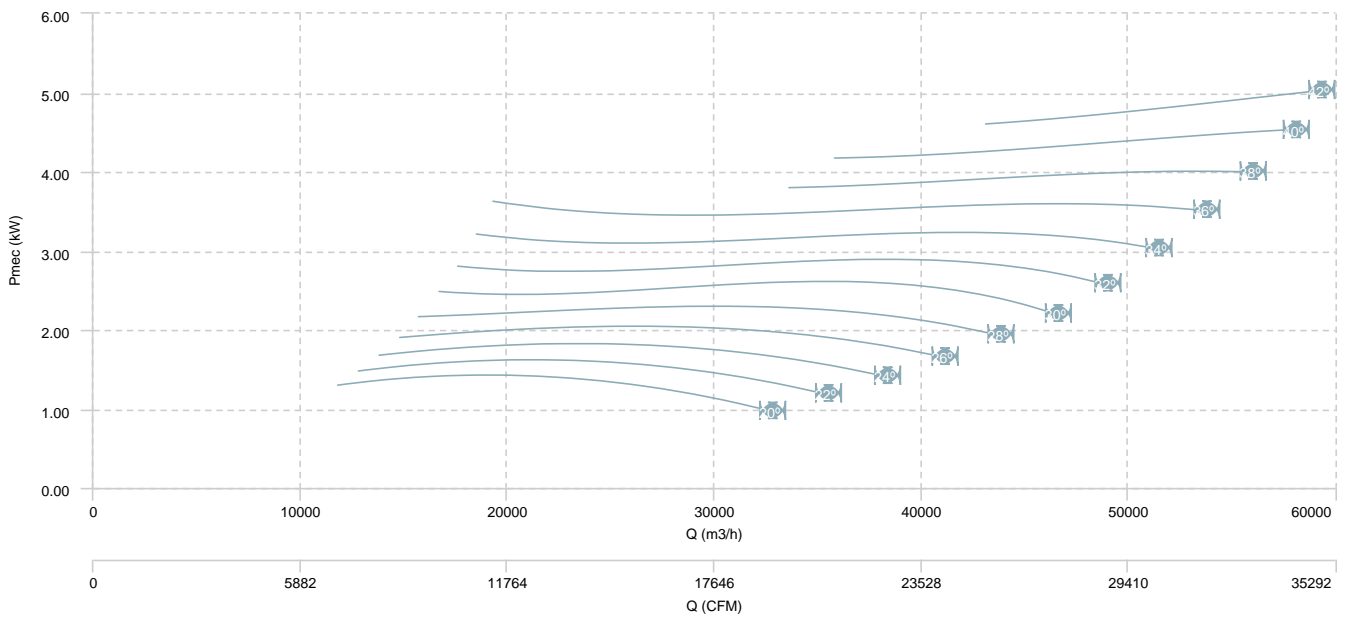

HMXF 112 T6 (A3:8) F400

AIR FLOW - PRESSURE

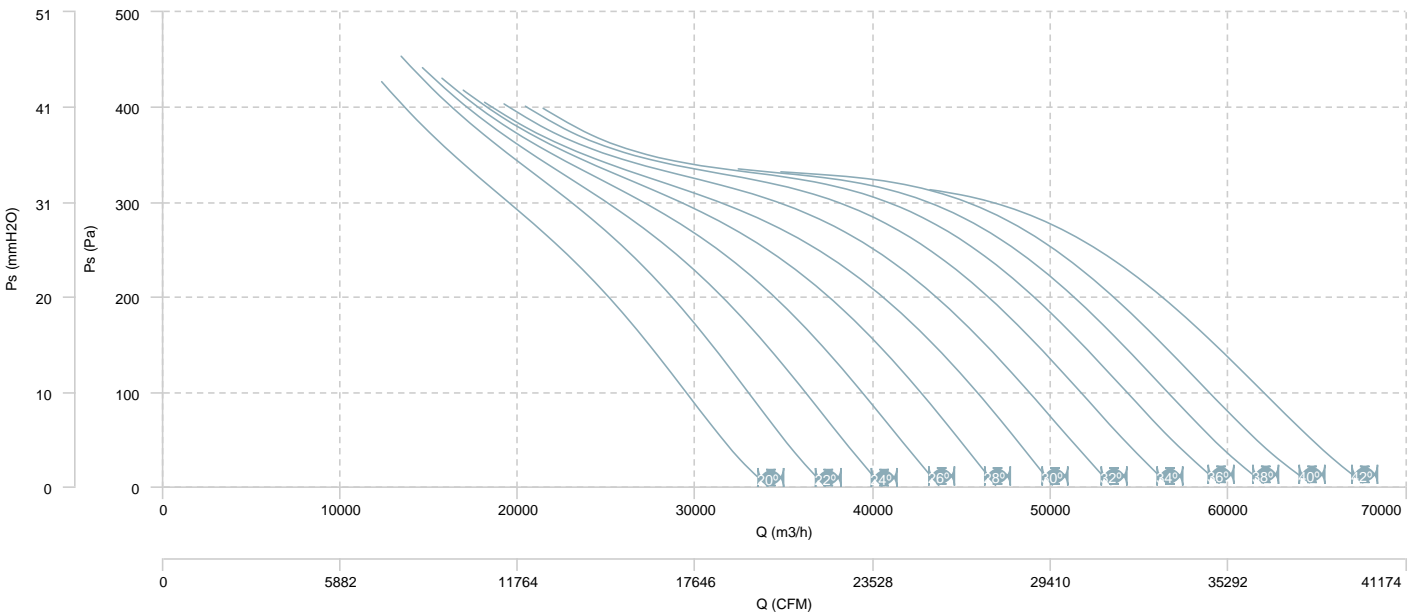

AIR FLOW - MECHANICAL POWER

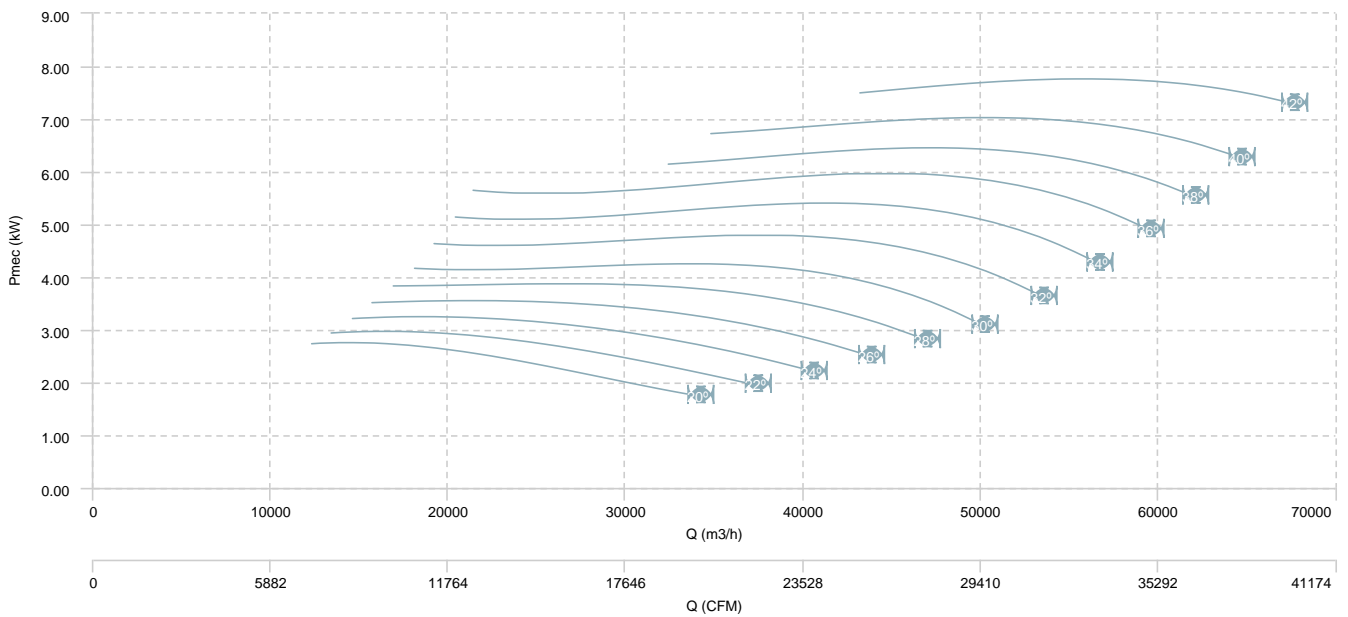

HMXF 112 T4/T6 (A3:4) F400

AIR FLOW - PRESSURE (4 poles)

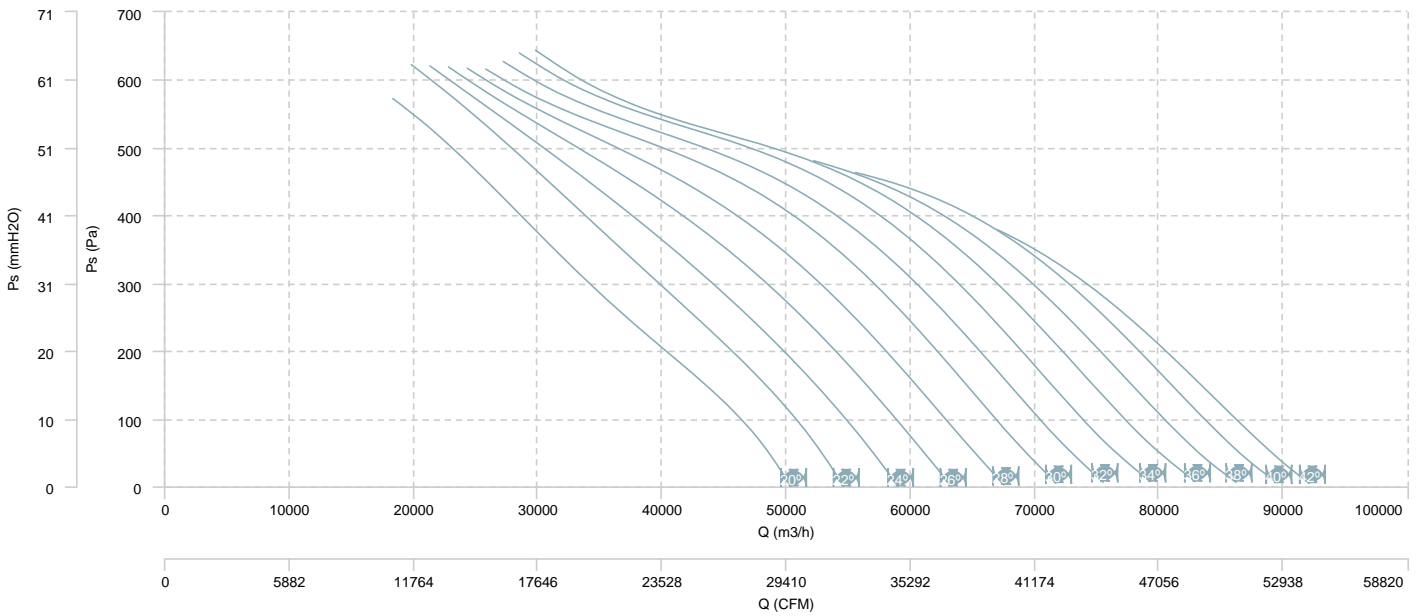

AIR FLOW - MECHANICAL POWER (4 poles)

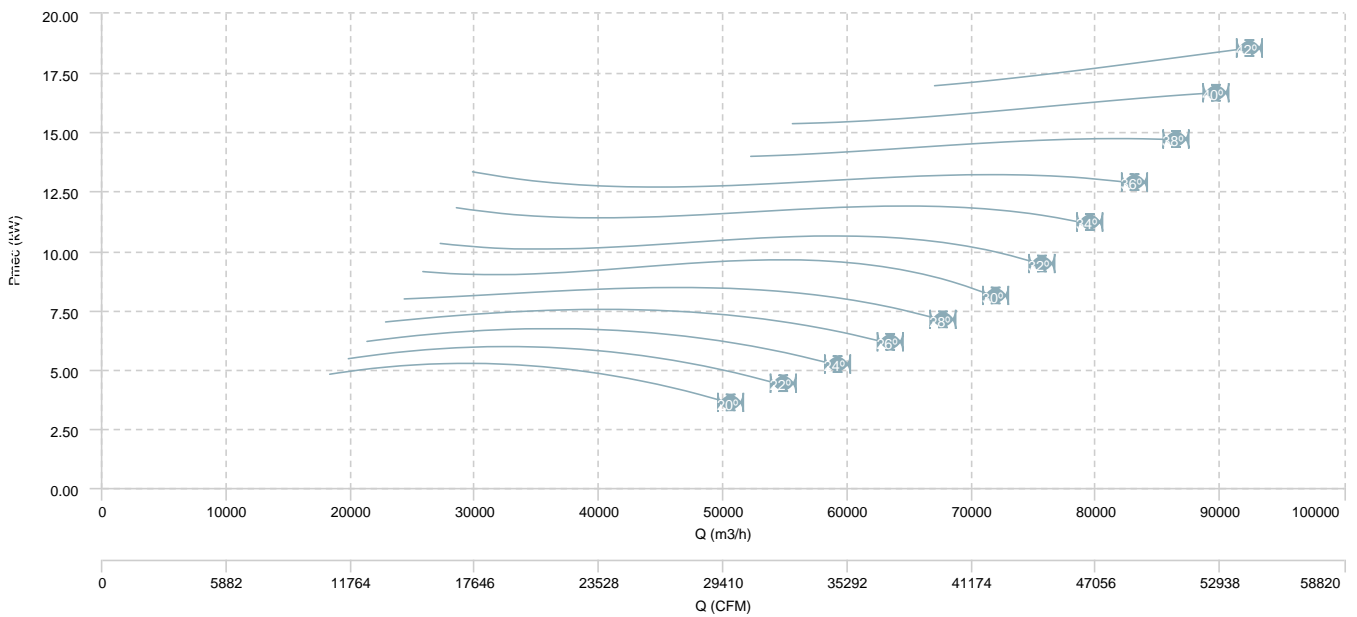

HMXF 112 T4/T6 (A3:4) F400

AIR FLOW - PRESSURE (6 poles)

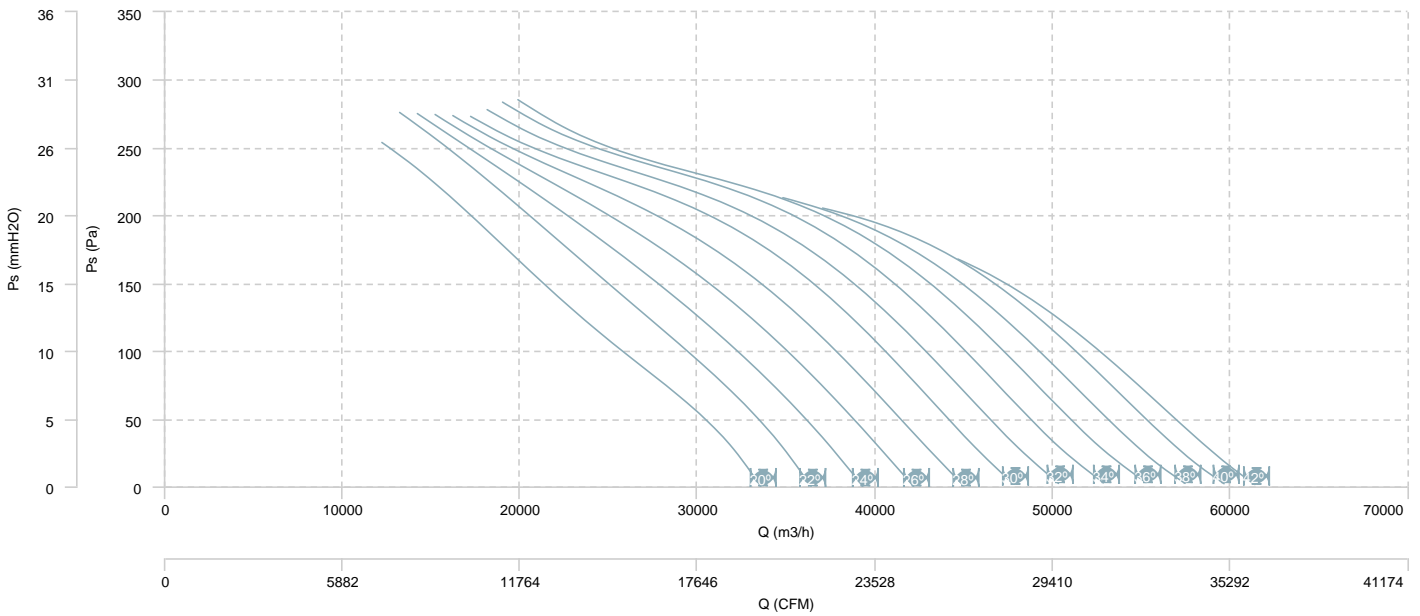

AIR FLOW - MECHANICAL POWER (6 poles)

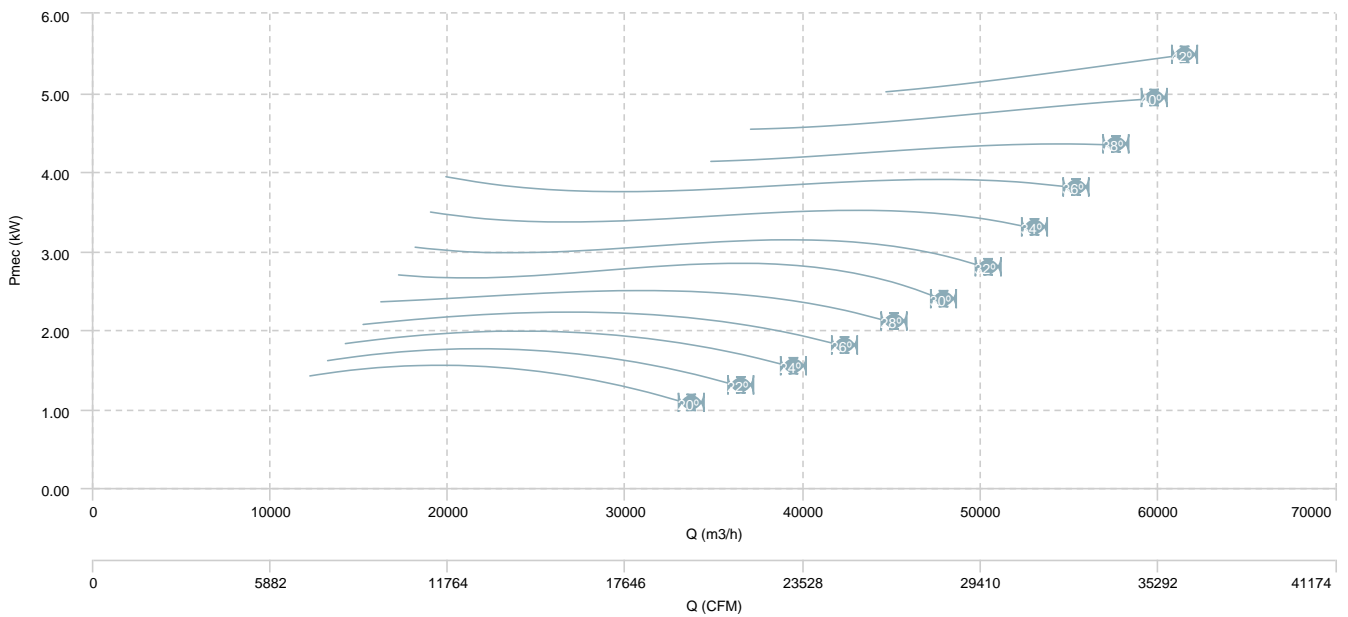

HMXF 112 T4/T6 (A3:8) F400

AIR FLOW - PRESSURE (4 poles)

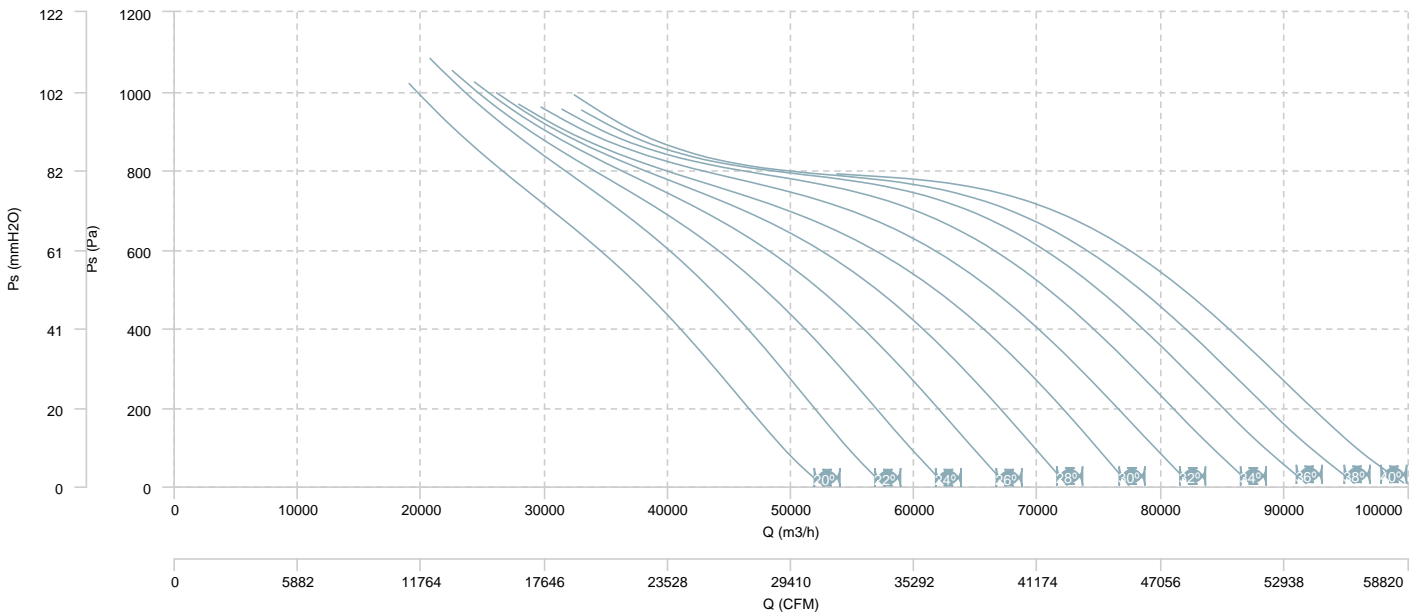

AIR FLOW - MECHANICAL POWER (4 poles)

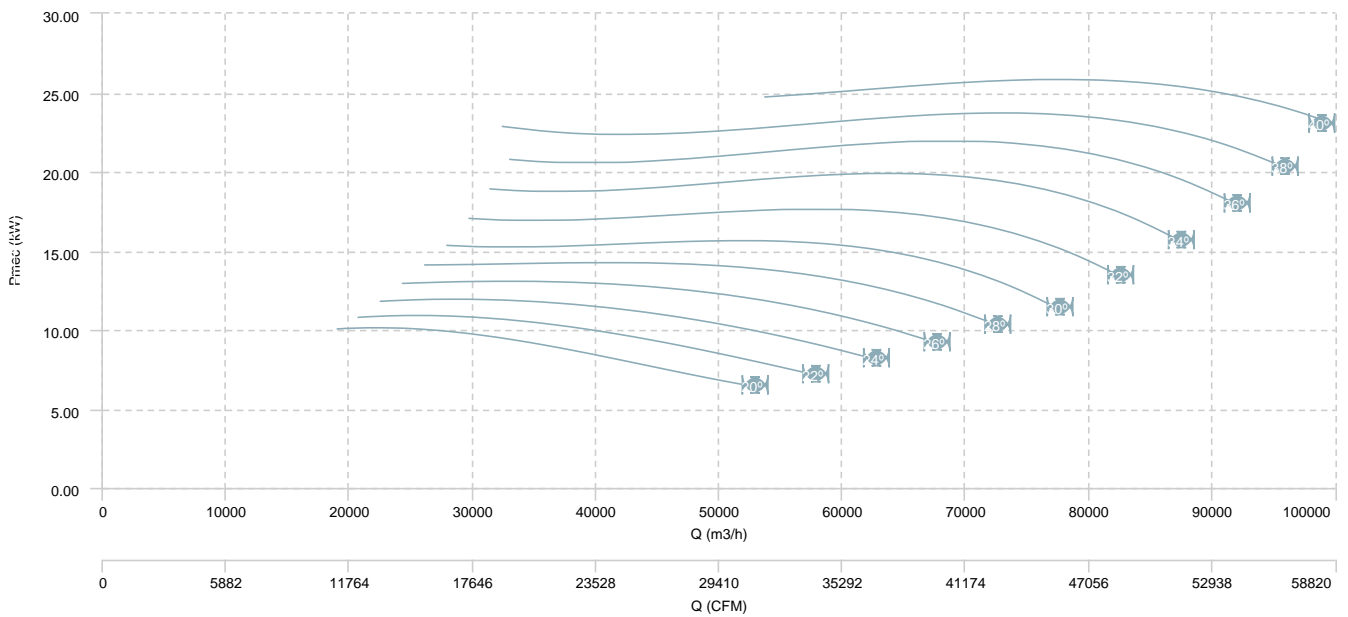

HMXF 112 T4/T6 (A3:8) F400

AIR FLOW - PRESSURE (6 poles)

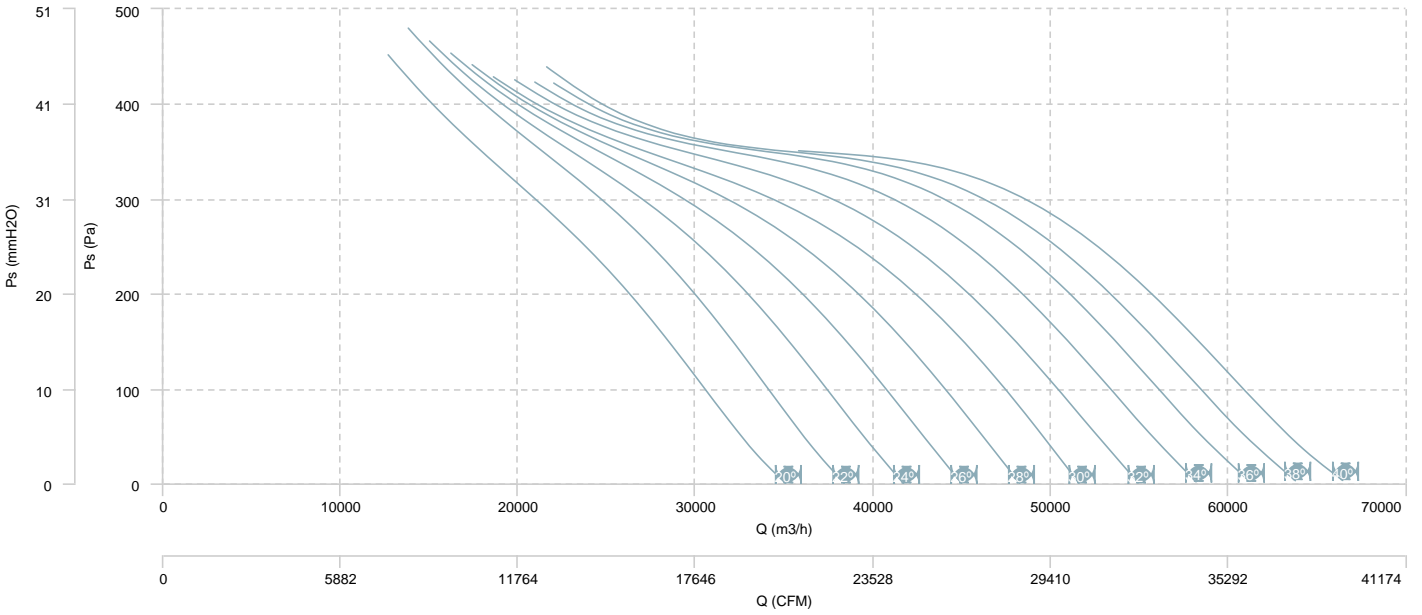

AIR FLOW - MECHANICAL POWER (6 poles)

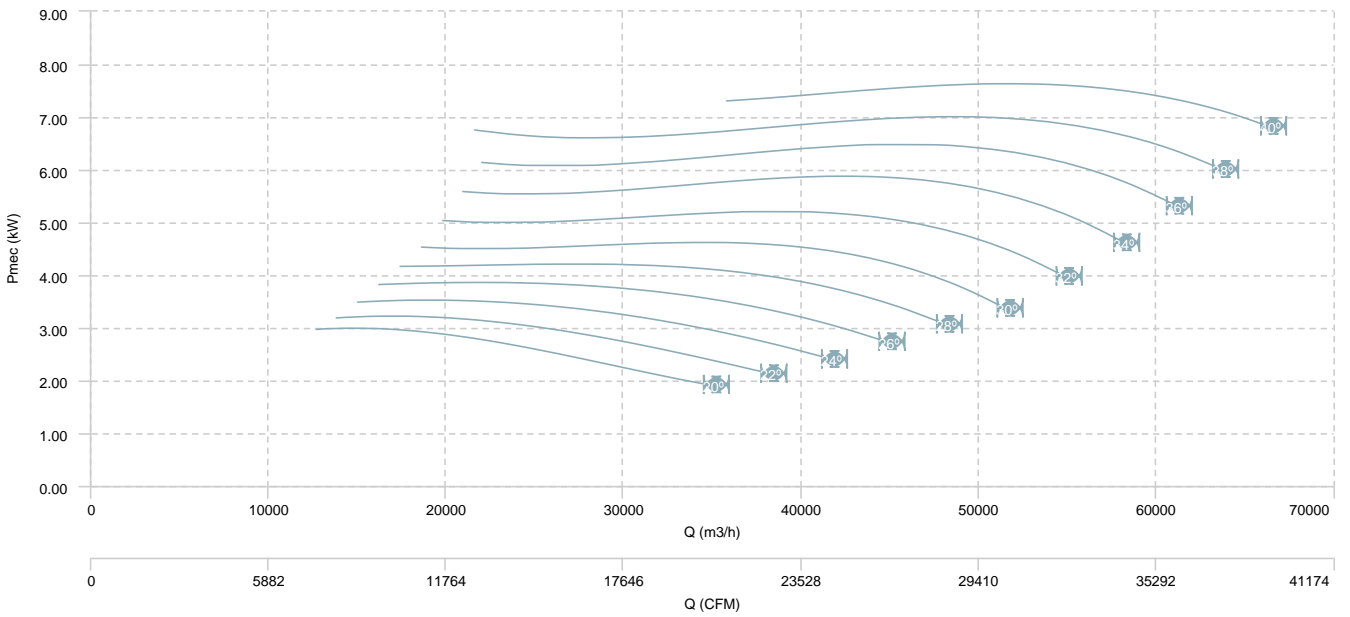



HMXF 112 T4/T8 (A3:4) F400

AIR FLOW - PRESSURE (4 poles)

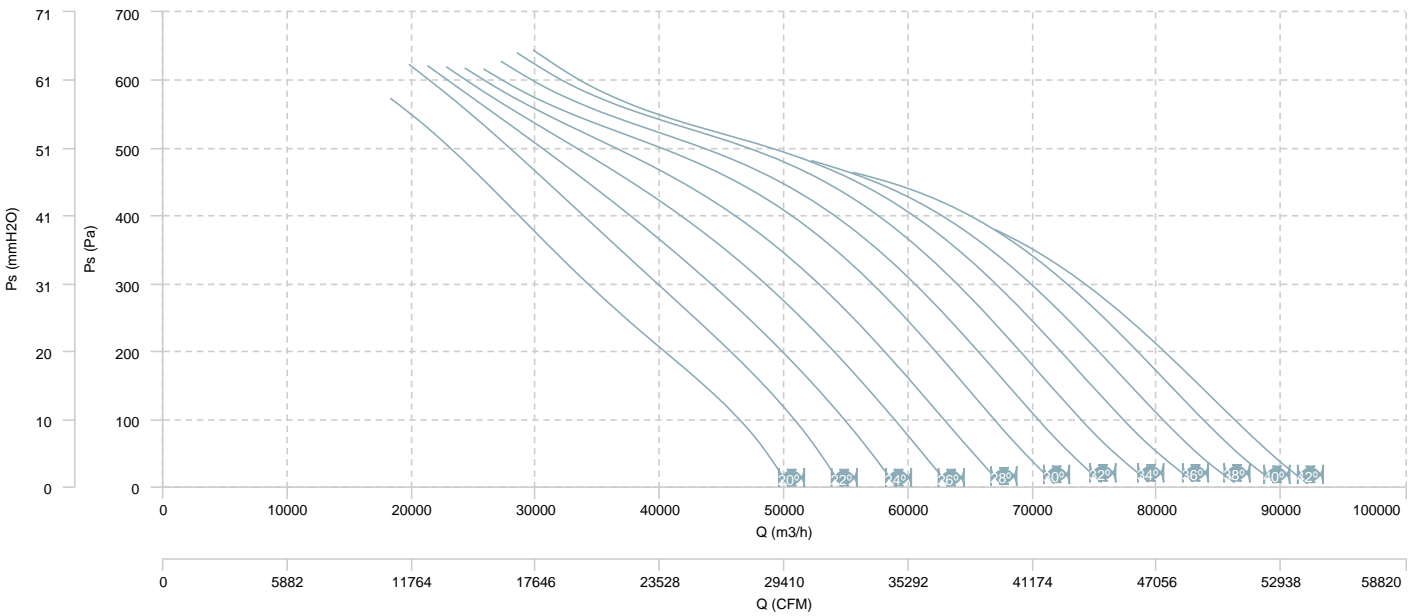

AIR FLOW - MECHANICAL POWER (4 poles)

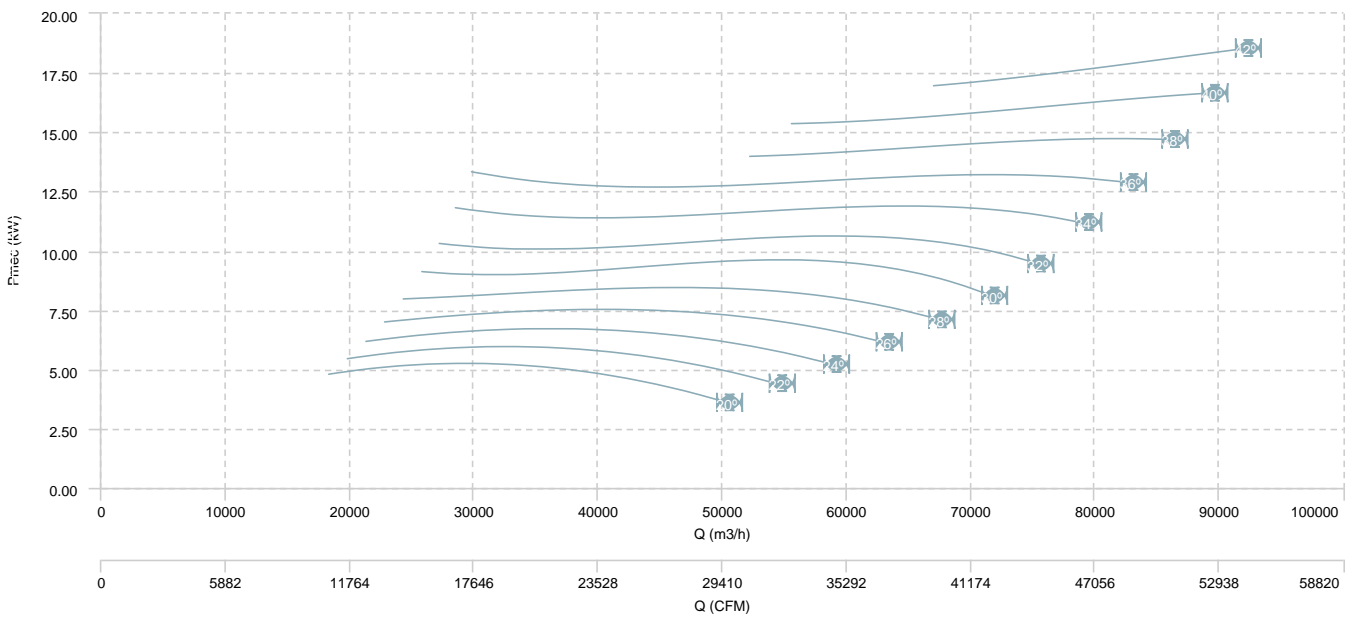

HMXF 112 T4/T8 (A3:4) F400

AIR FLOW - PRESSURE (8 poles)

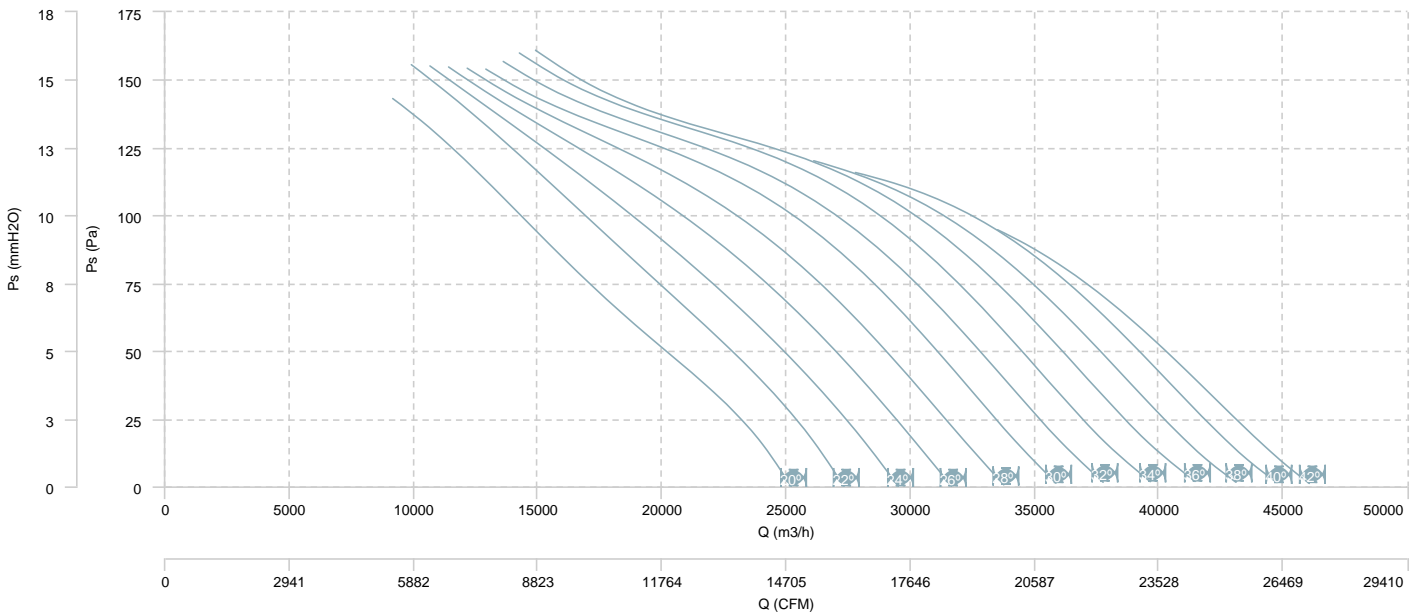

AIR FLOW - MECHANICAL POWER (8 poles)

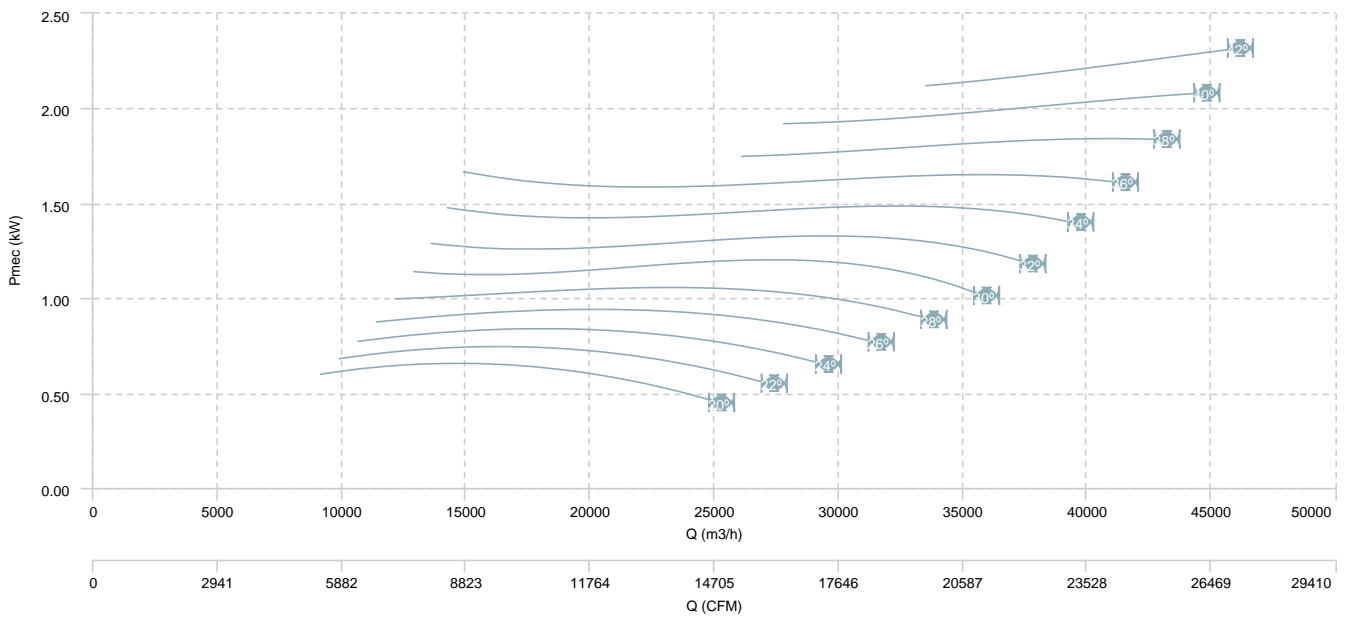

HMXF 112 T4/T8 (A3:8) F400

AIR FLOW - PRESSURE (4 poles)

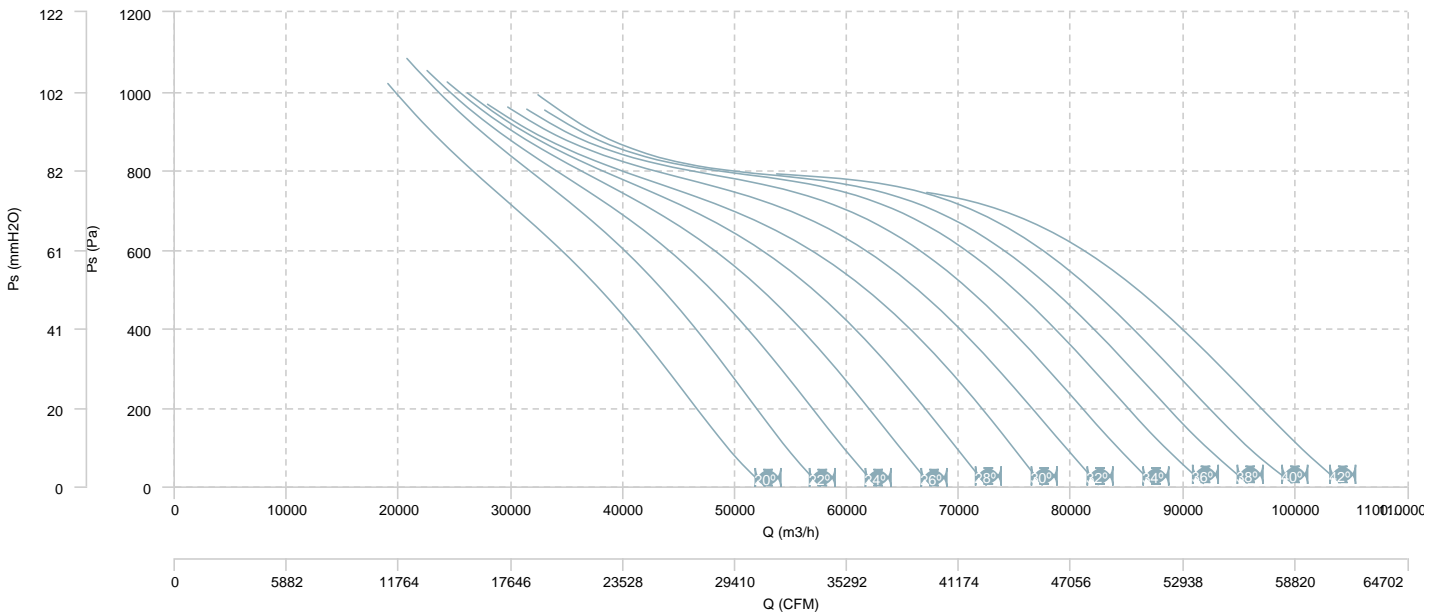

AIR FLOW - MECHANICAL POWER (4 poles)

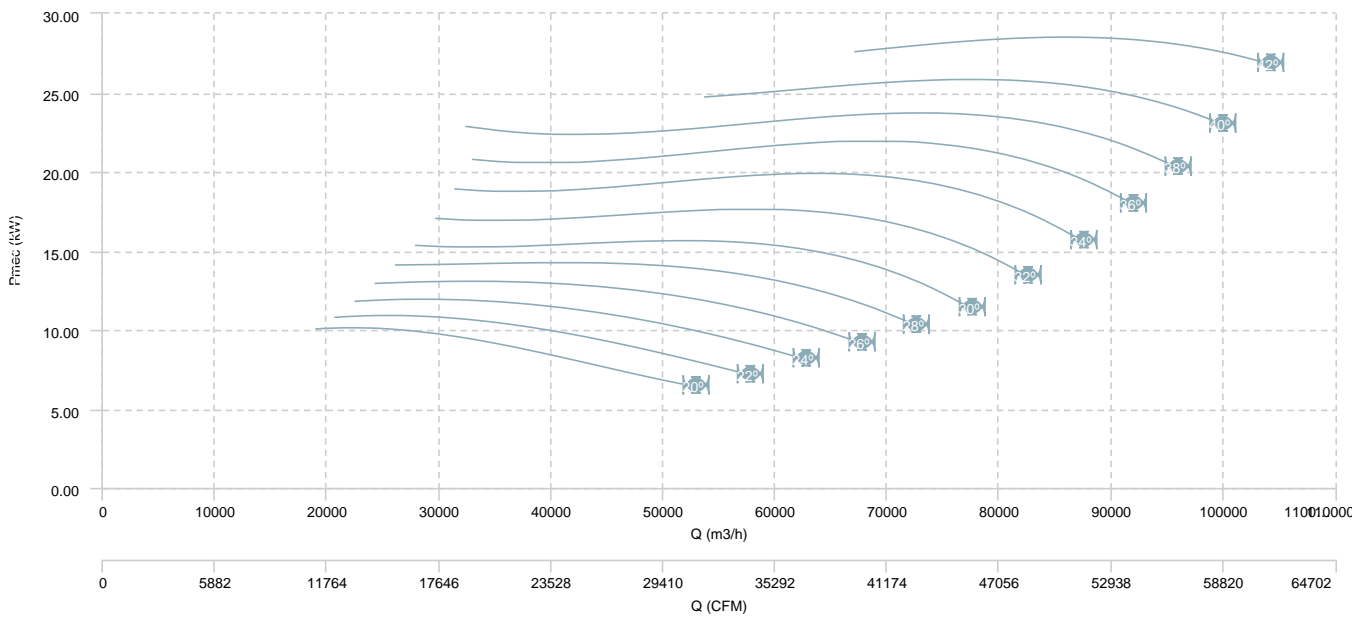

HMXF 112 T4/T8 (A3:8) F400

AIR FLOW - PRESSURE (8 poles)

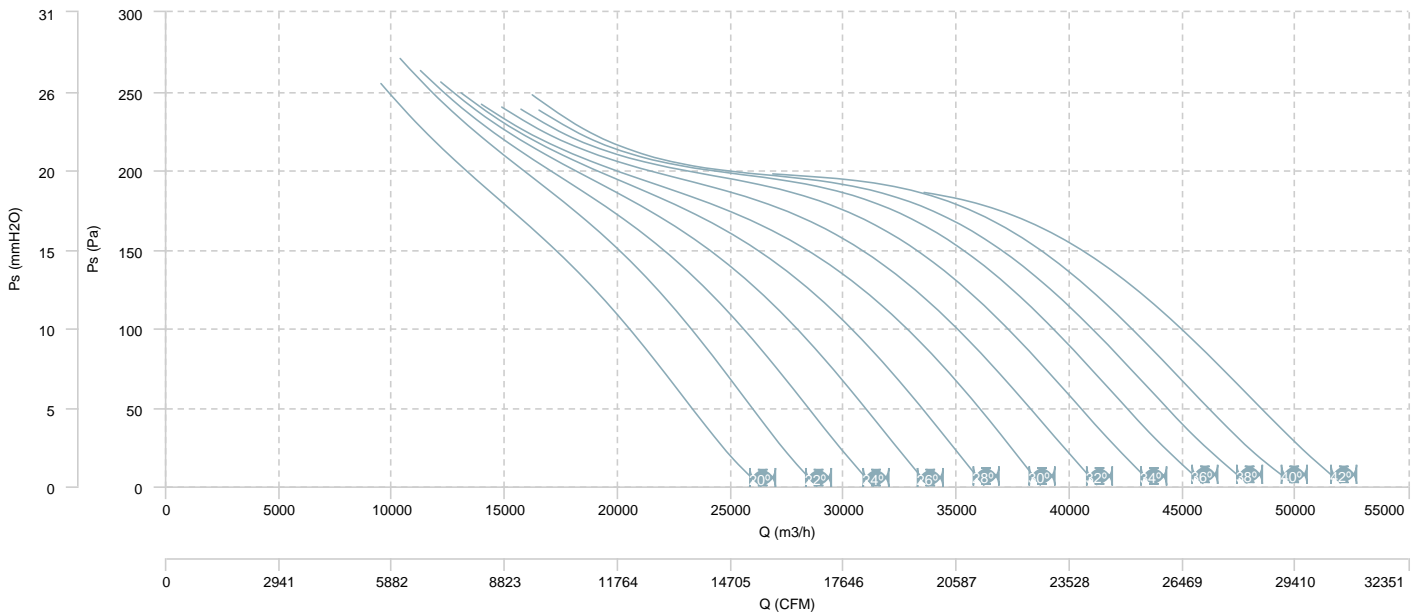

AIR FLOW - MECHANICAL POWER (8 poles)

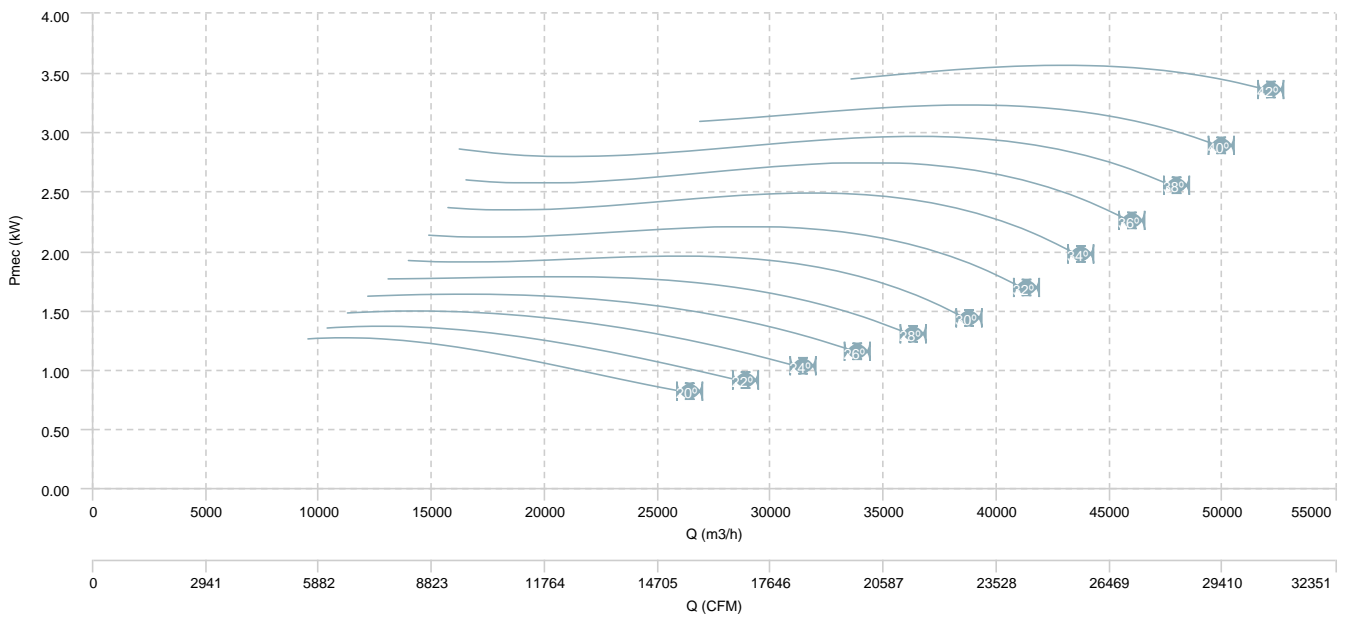

HMFx 125 T4 (A3:4) F400

AIR FLOW - PRESSURE

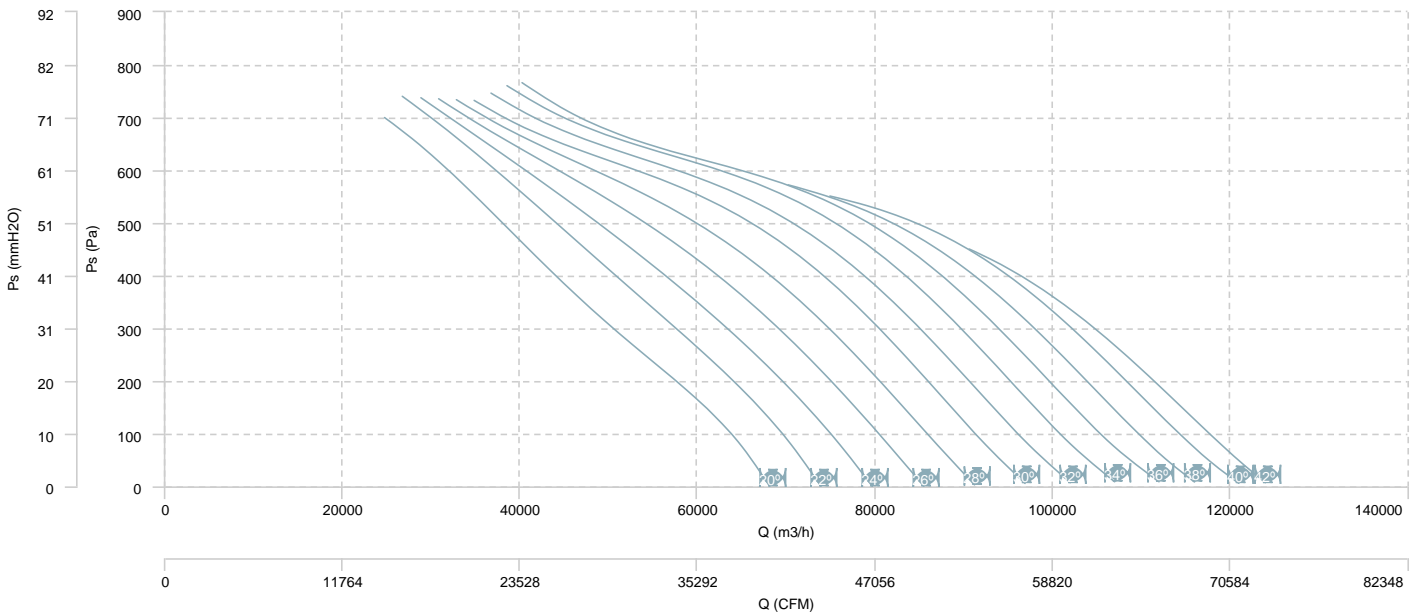

HMXF 125 T4 (A3:8) F400

AIR FLOW - PRESSURE

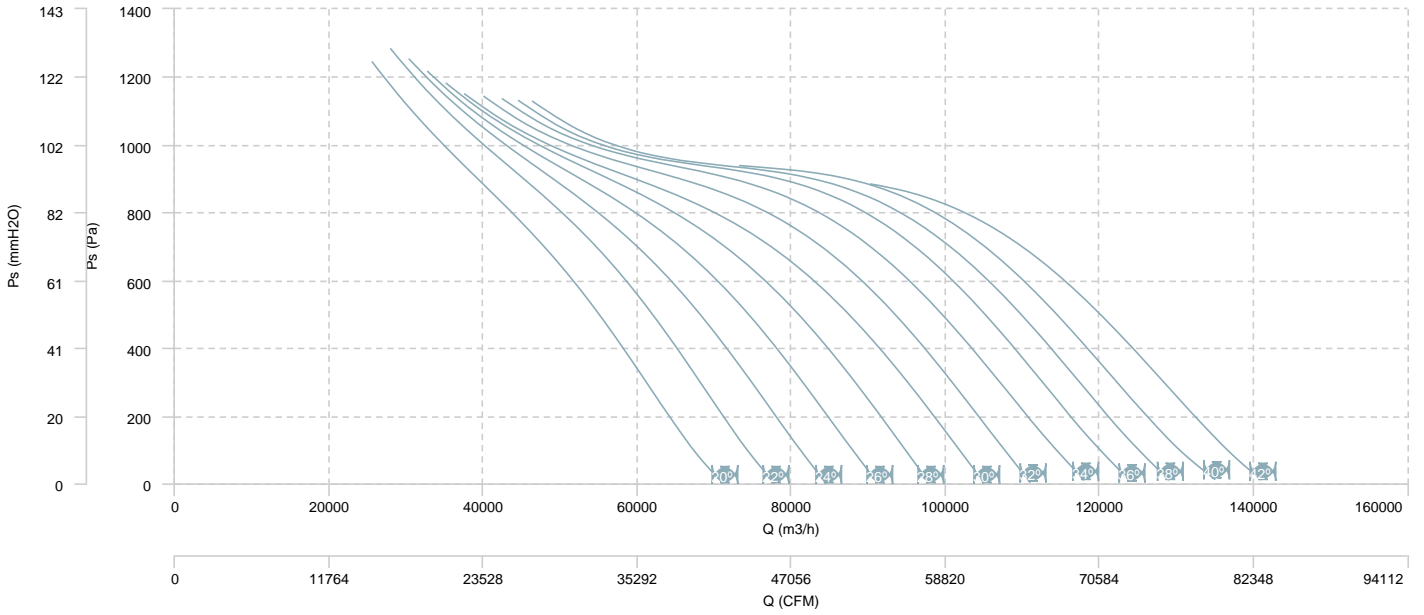

AIR FLOW - MECHANICAL POWER

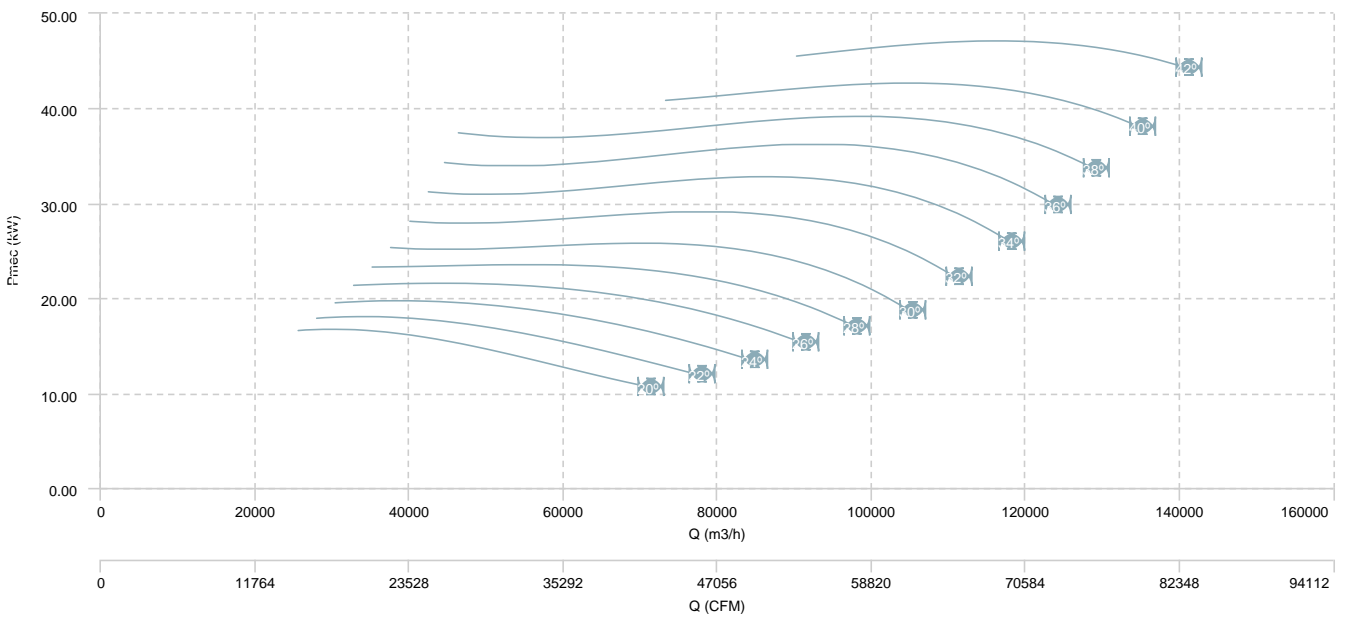

HMXF 125 T6 (A3:4) F400

AIR FLOW - PRESSURE

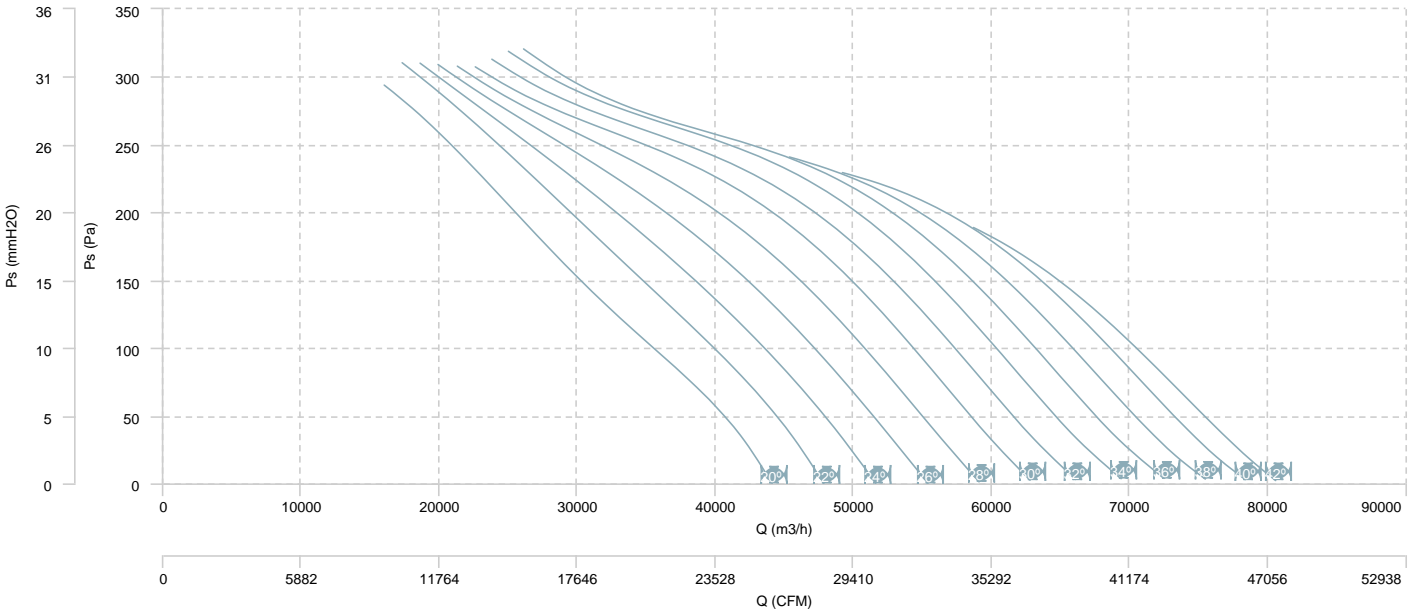

AIR FLOW - MECHANICAL POWER

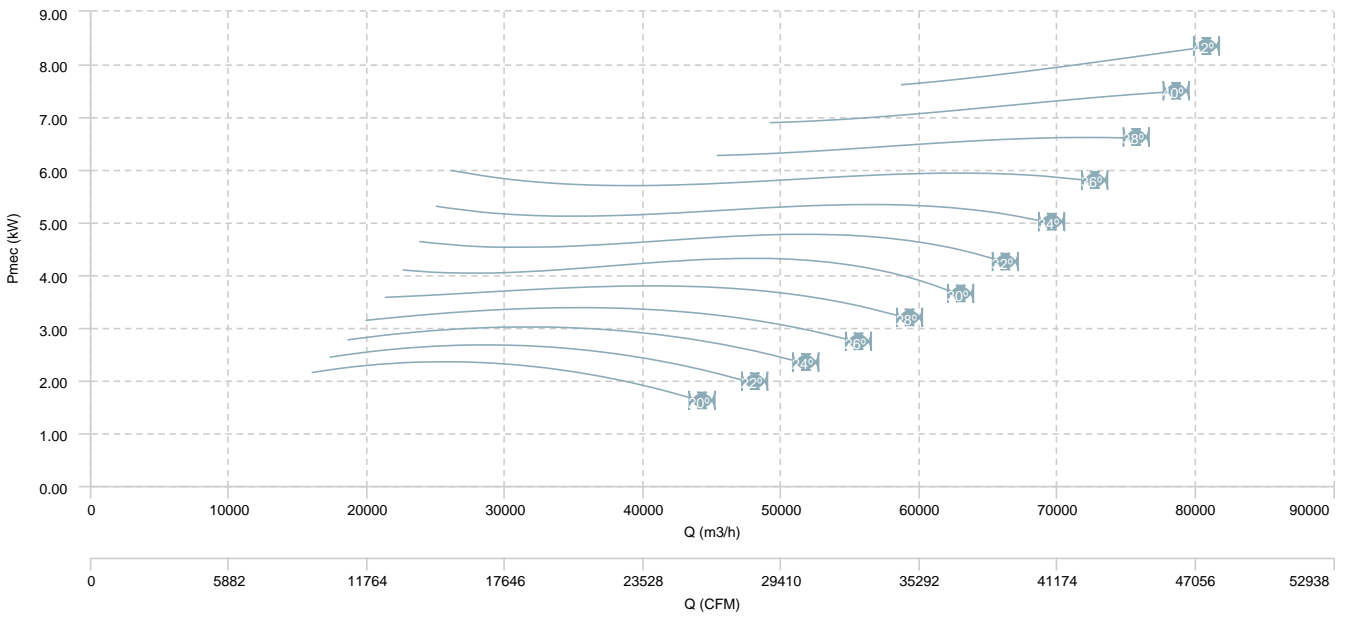

HMXF 125 T6 (A3:8) F400

AIR FLOW - PRESSURE

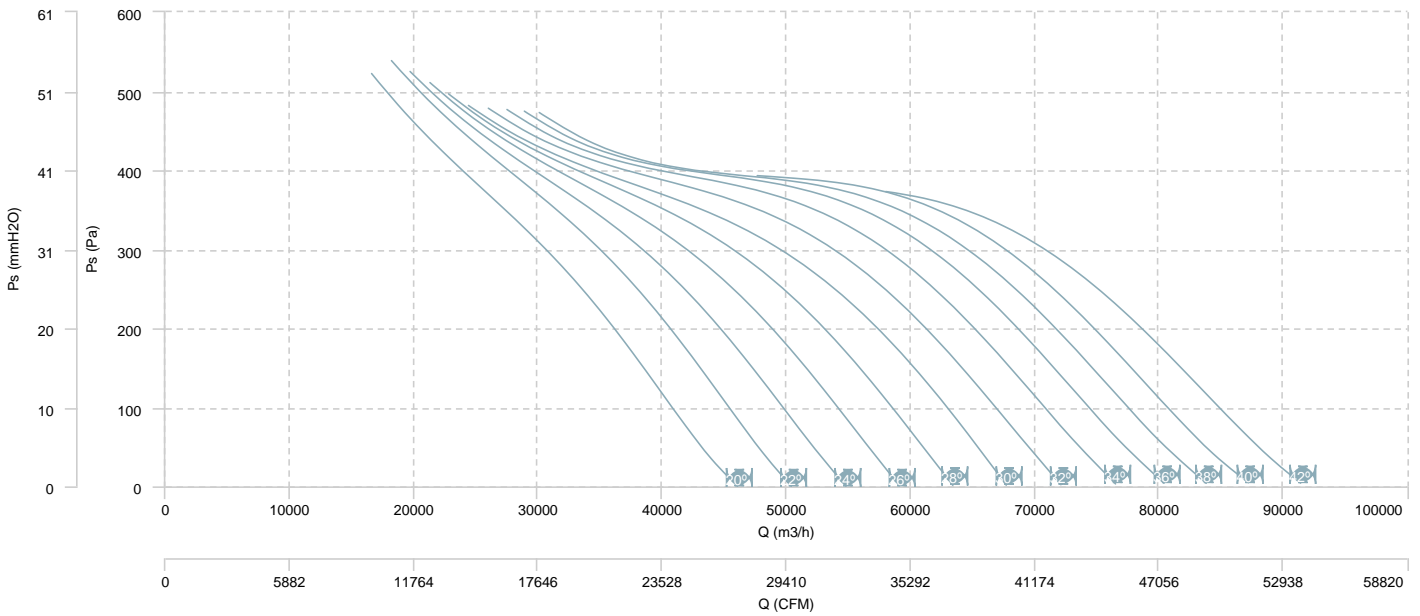

AIR FLOW - MECHANICAL POWER

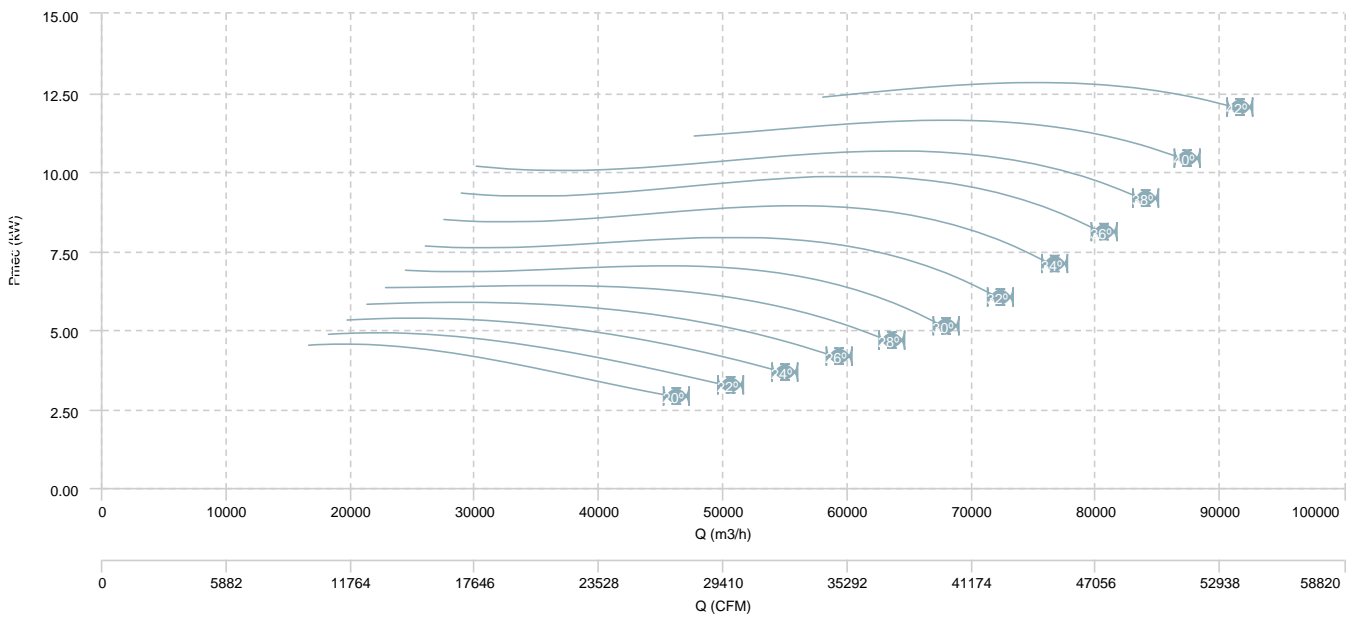



HMX 125 T4/T6 (A3:4) F400

AIR FLOW - PRESSURE (4 poles)

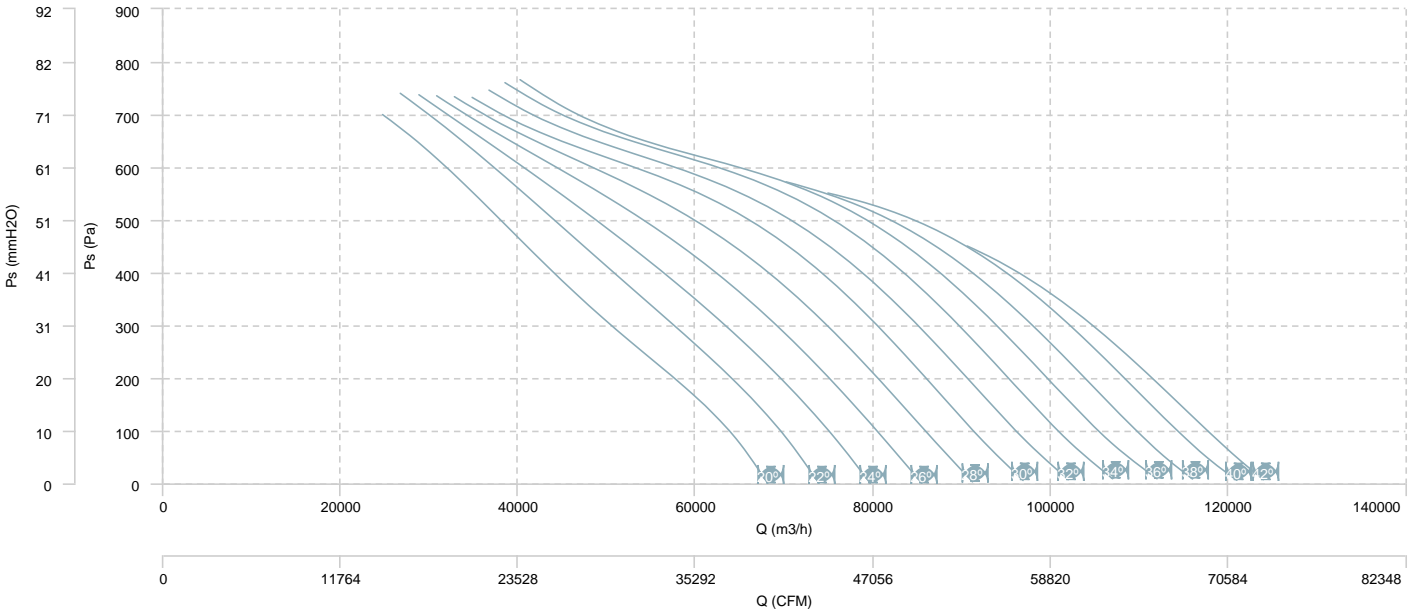

AIR FLOW - MECHANICAL POWER (4 poles)

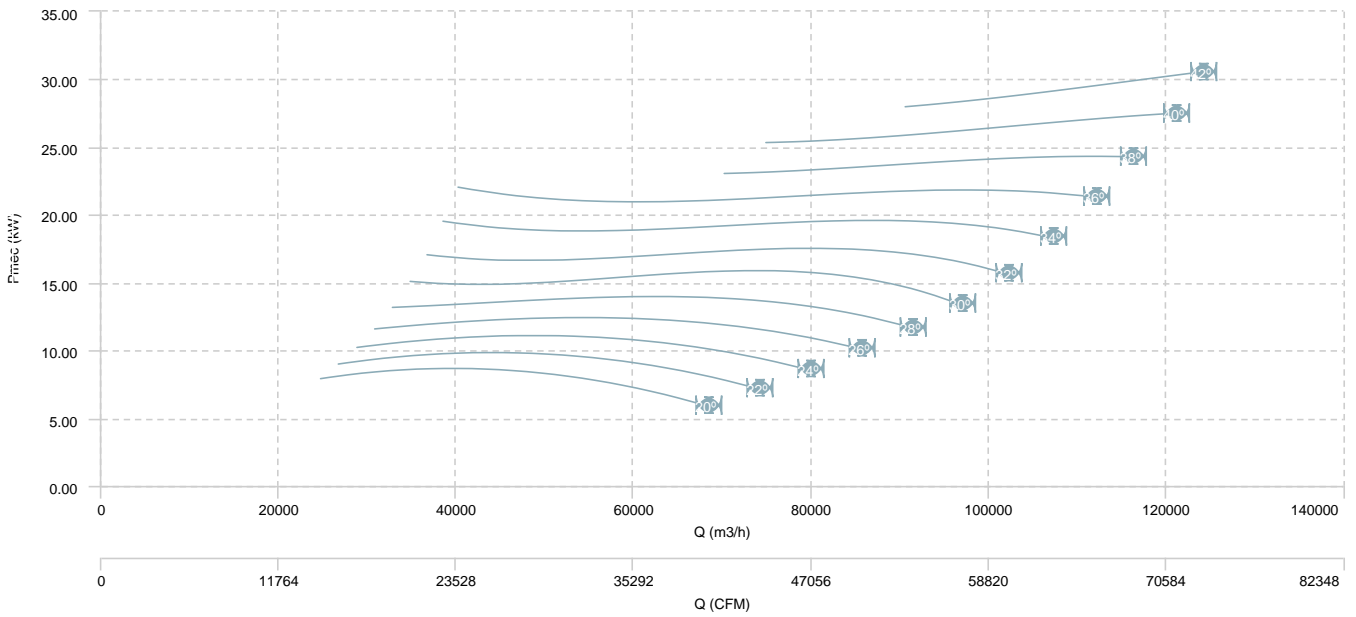

HMFx 125 T4/T6 (A3:4) F400

AIR FLOW - PRESSURE (6 poles)

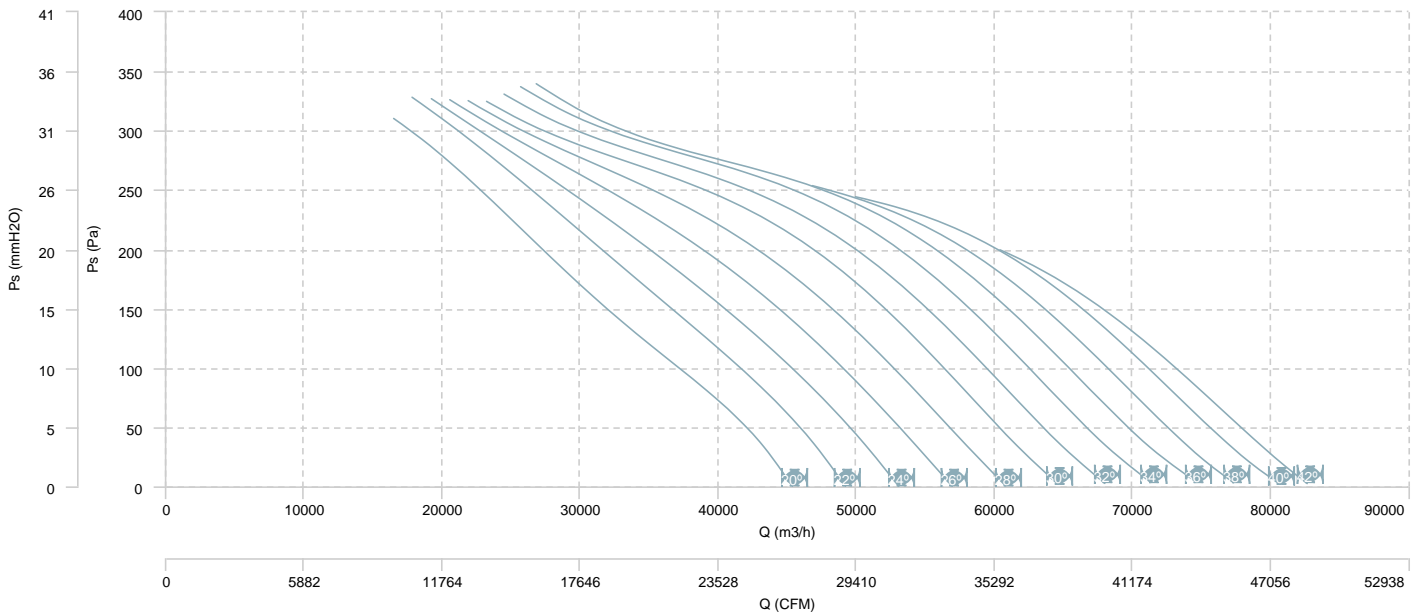

AIR FLOW - MECHANICAL POWER (6 poles)

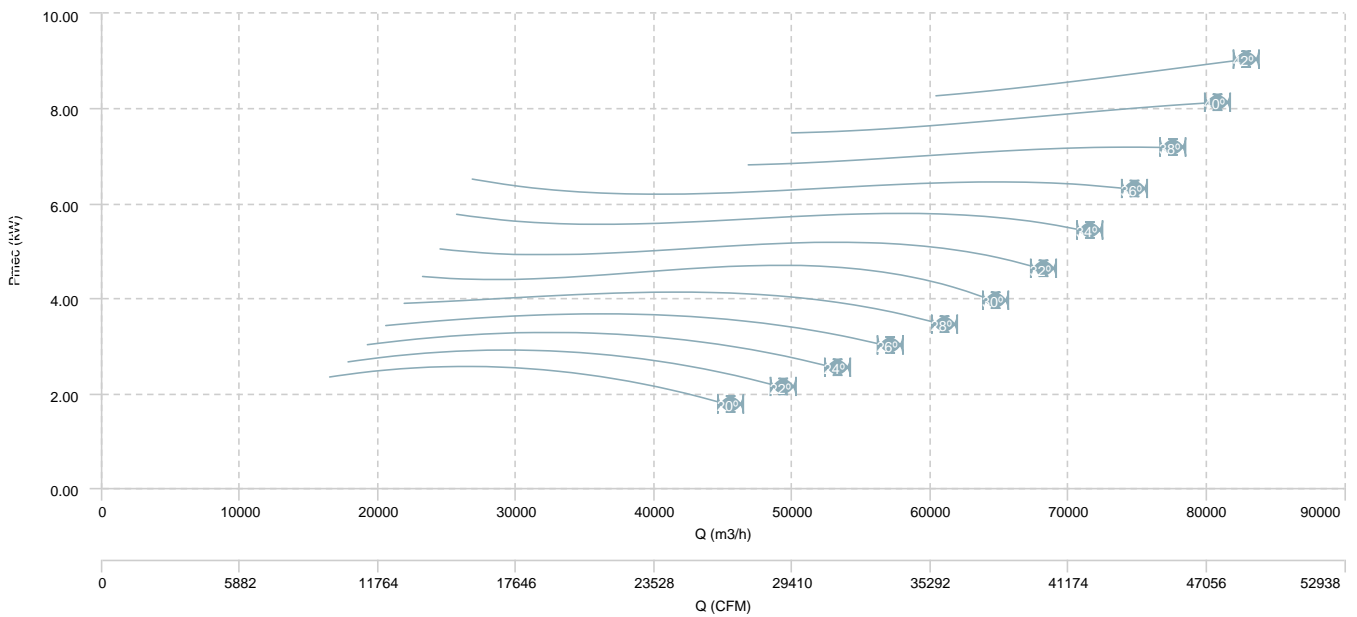

HMXF 125 T4/T6 (A3:8) F400

AIR FLOW - PRESSURE (4 poles)

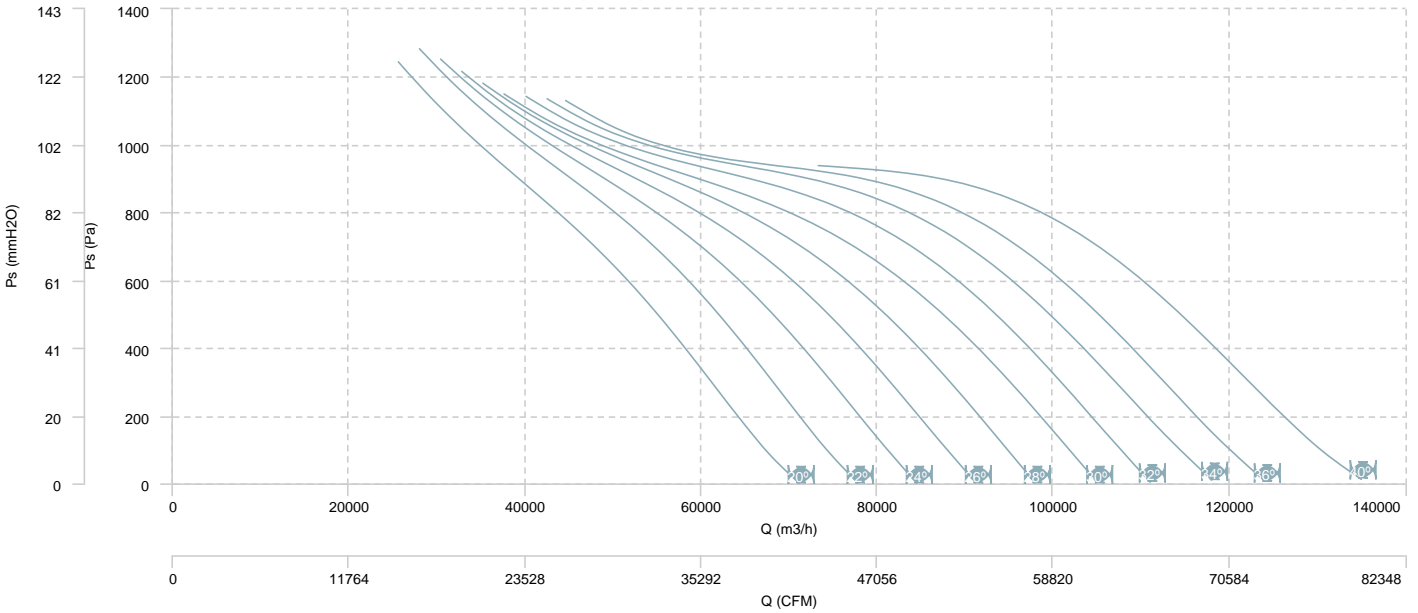

AIR FLOW - MECHANICAL POWER (4 poles)

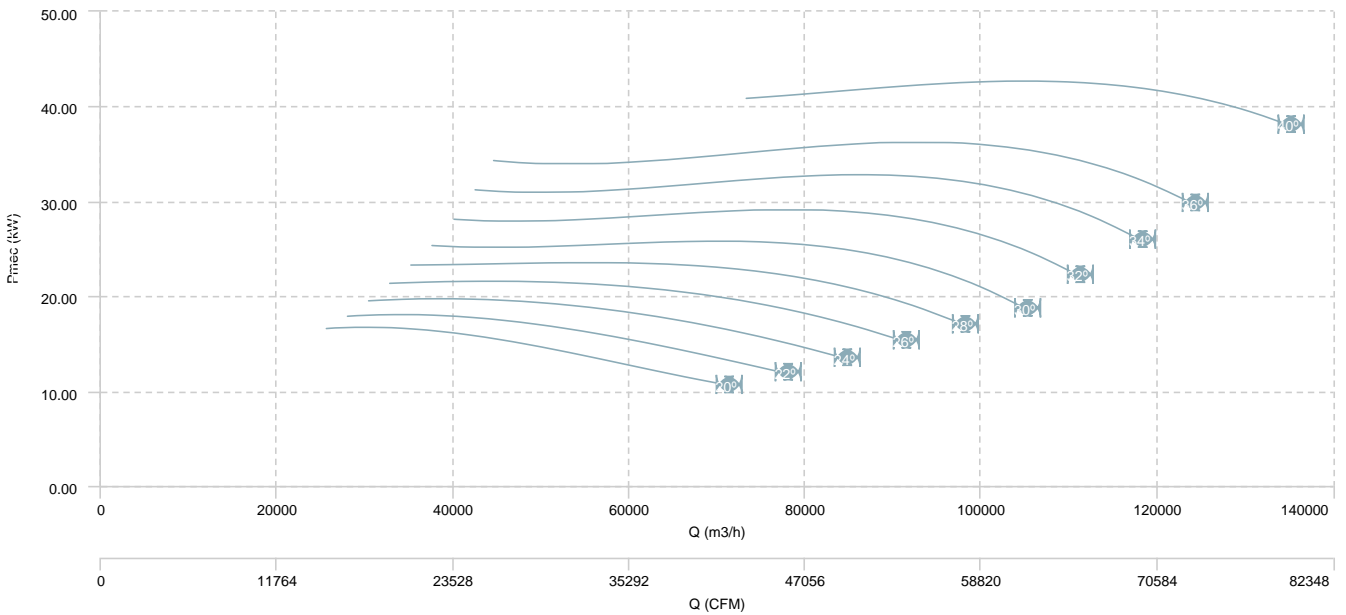

HMX 125 T4/T6 (A3:8) F400

AIR FLOW - PRESSURE (6 poles)

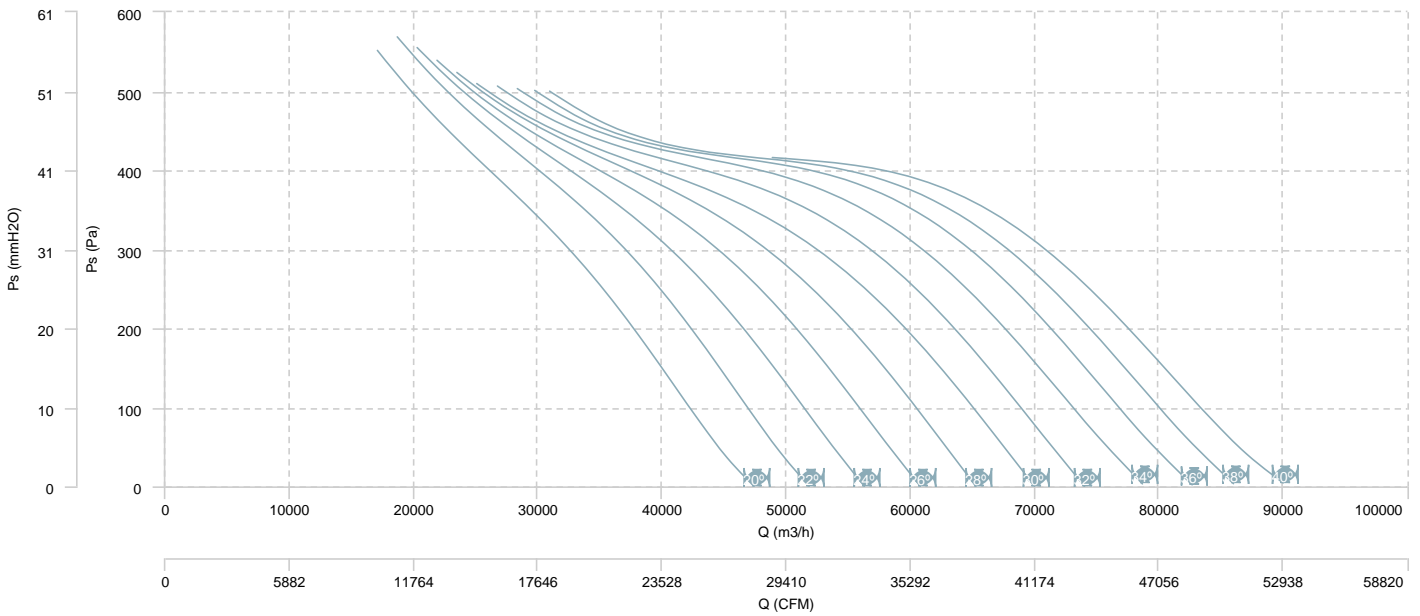

AIR FLOW - MECHANICAL POWER (6 poles)

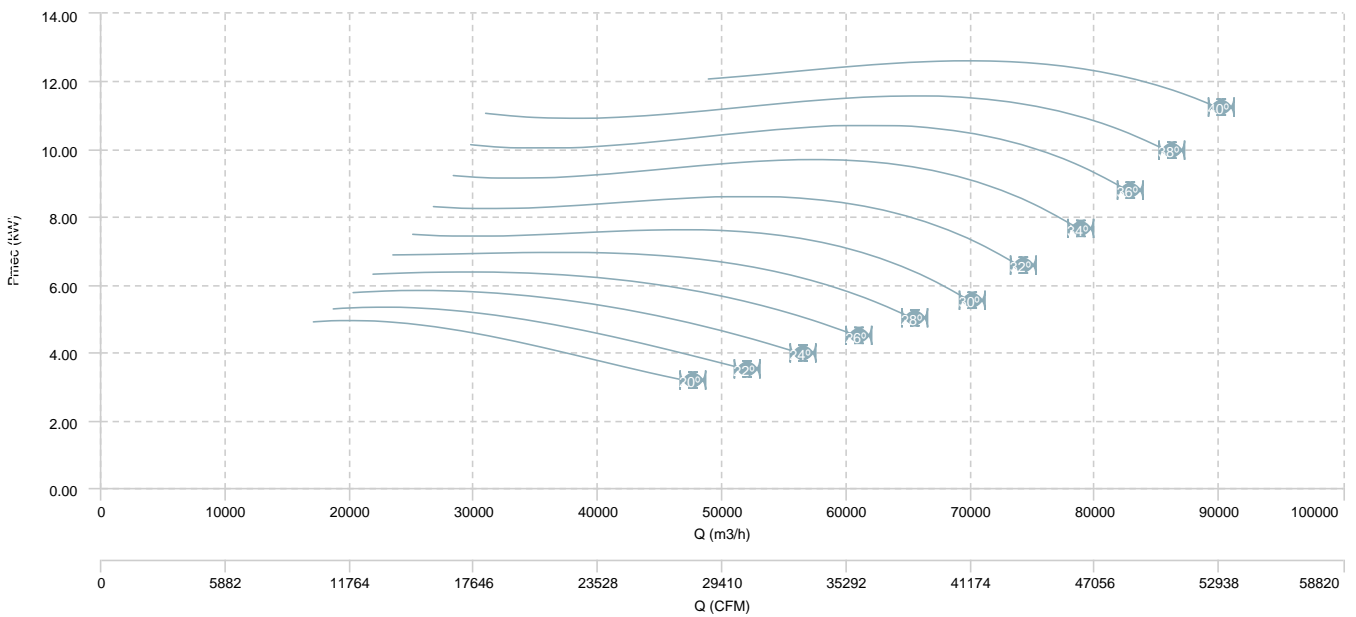

HMXF 125 T4/T8 (A3:4) F400

AIR FLOW - PRESSURE (4 poles)

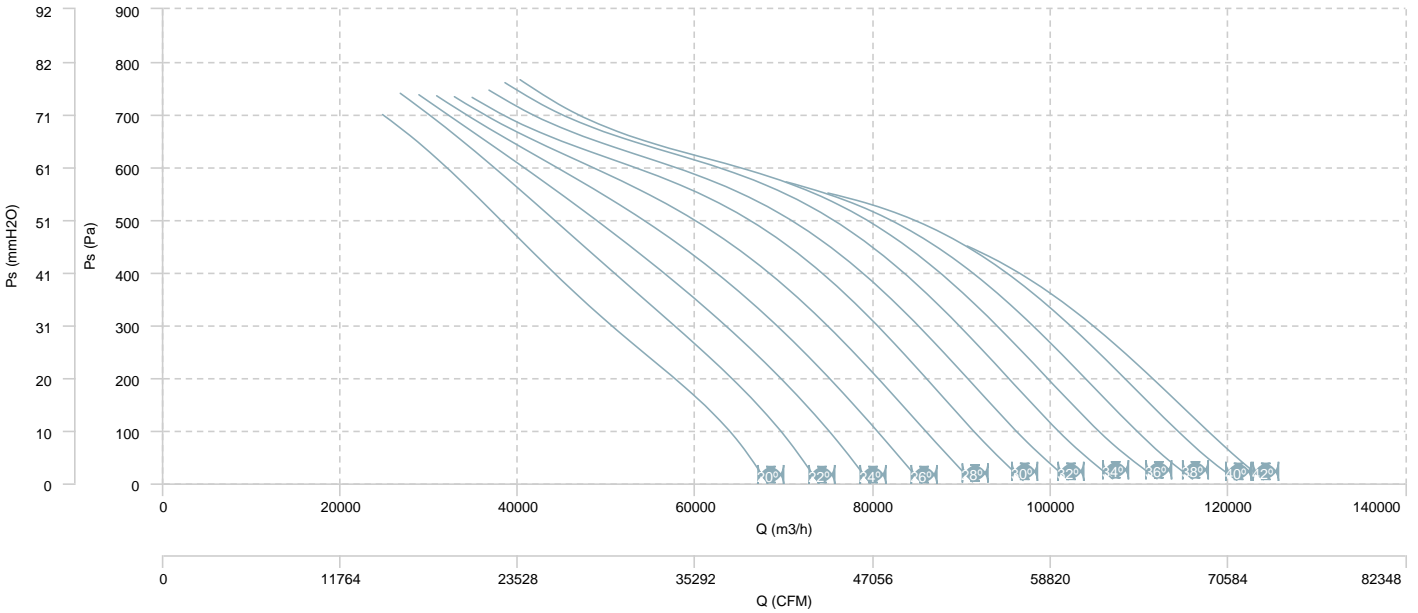

AIR FLOW - MECHANICAL POWER (4 poles)

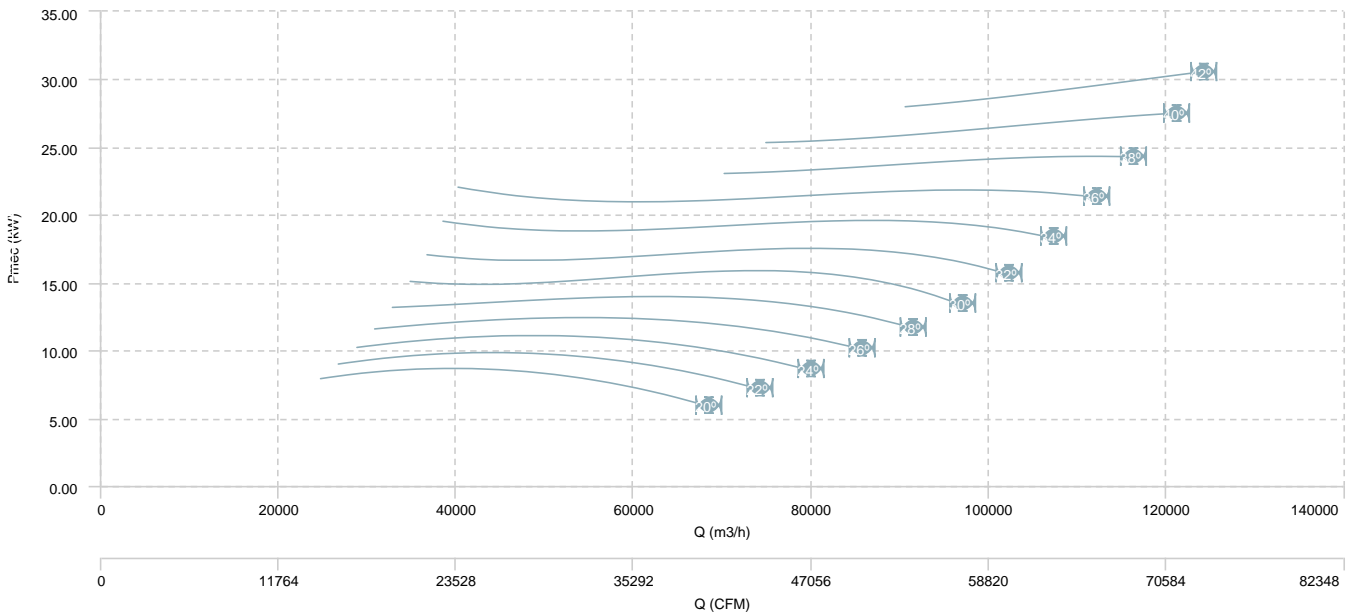

HMXF 125 T4/T8 (A3:4) F400

AIR FLOW - PRESSURE (8 poles)

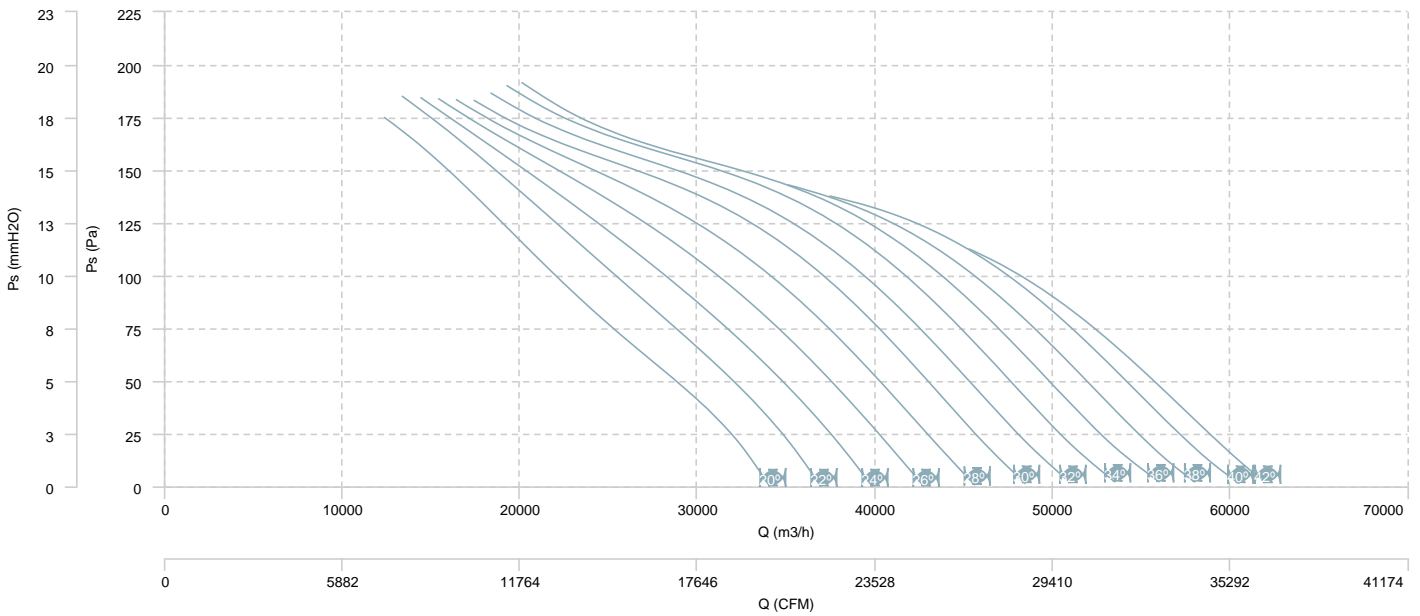

AIR FLOW - MECHANICAL POWER (8 poles)

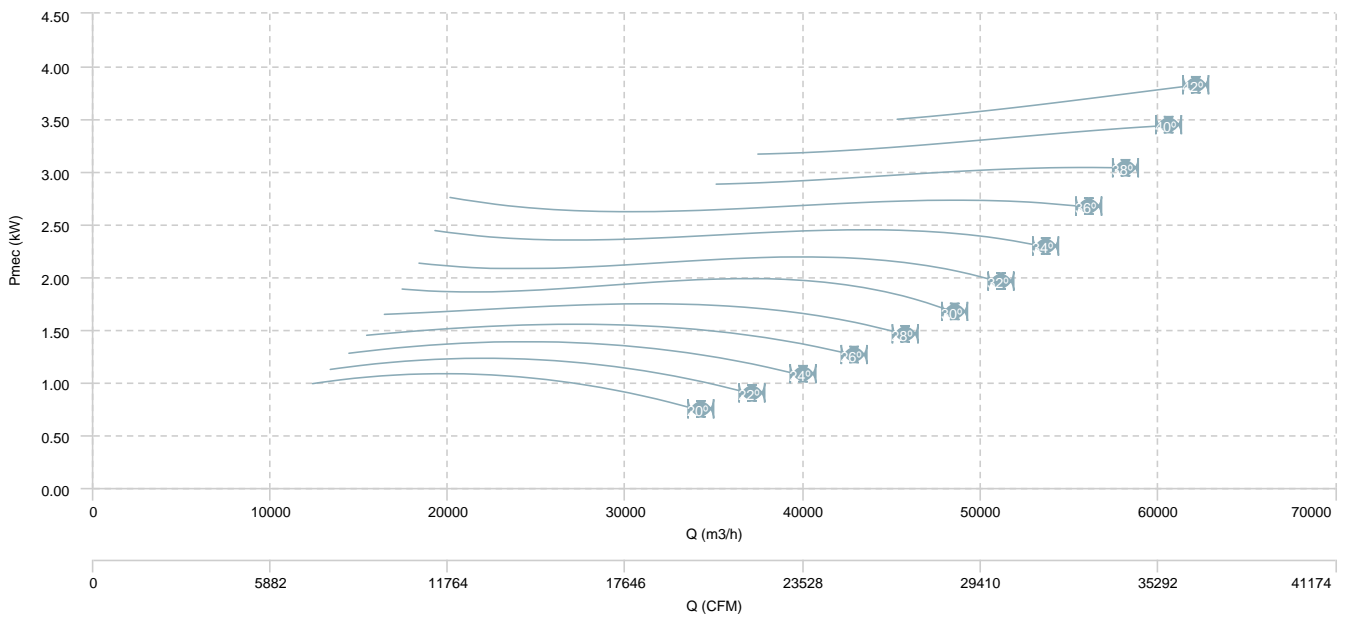

HMXF 125 T4/T8 (A3:8) F400

AIR FLOW - PRESSURE (4 poles)

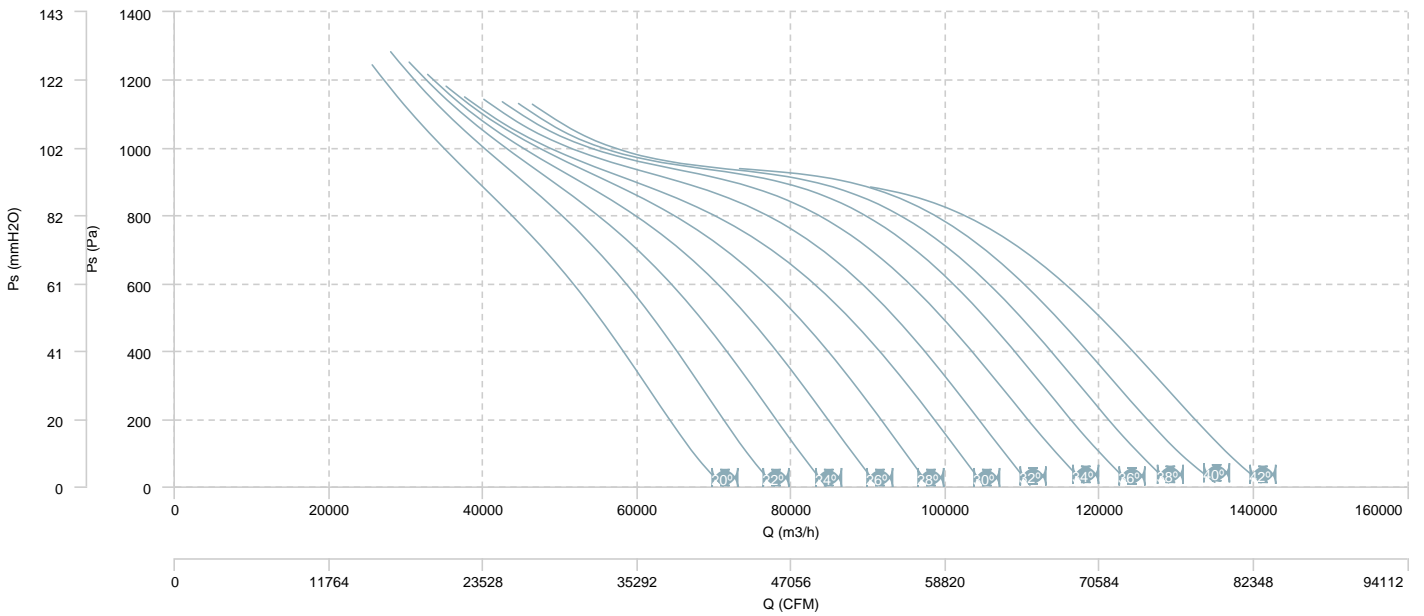

AIR FLOW - MECHANICAL POWER (4 poles)

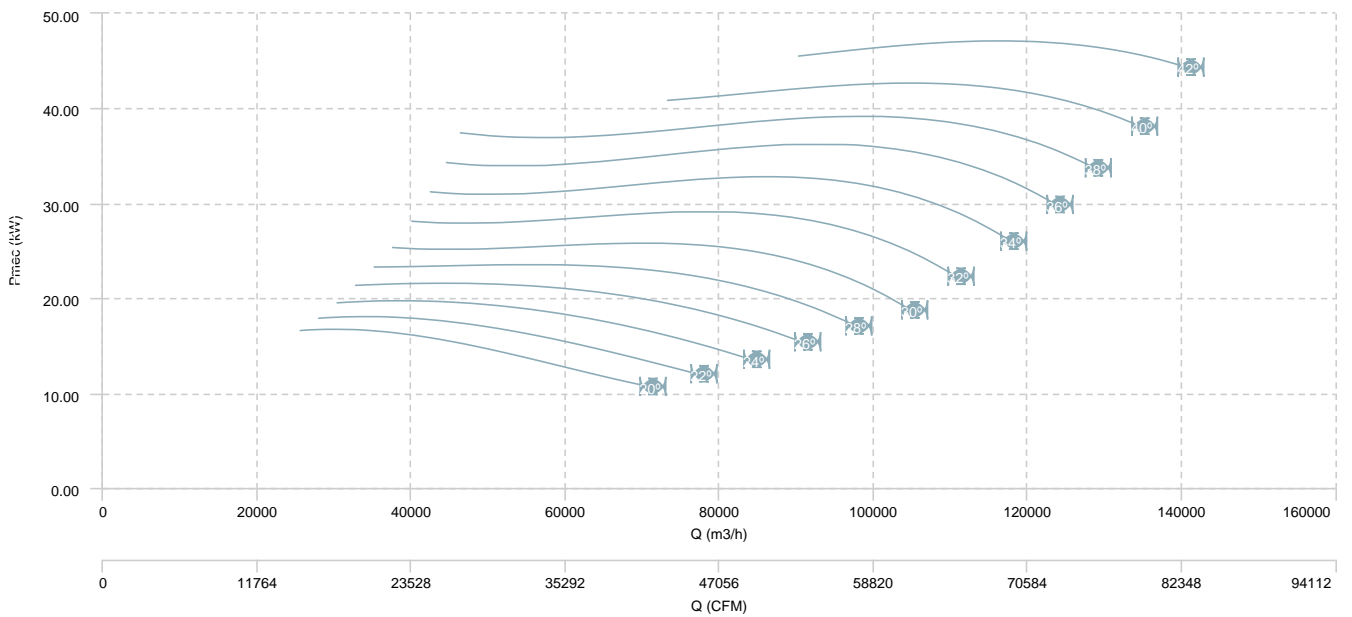

HMXF 125 T4/T8 (A3:8) F400

AIR FLOW - PRESSURE (8 poles)

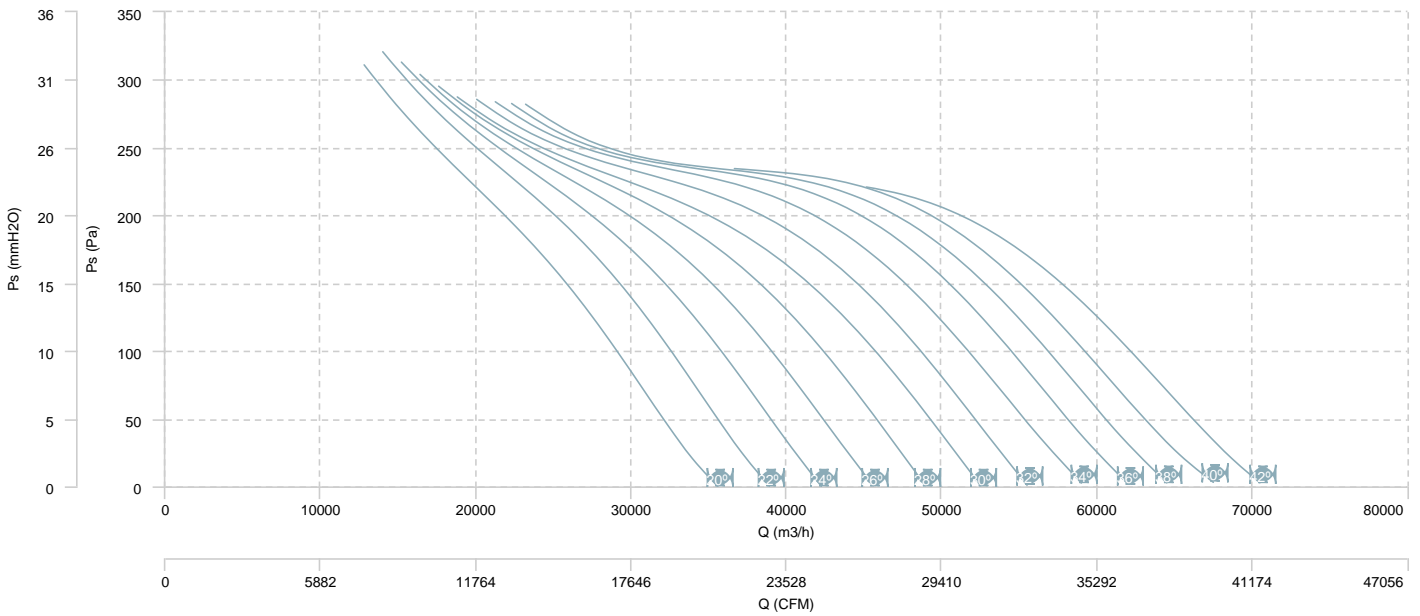

AIR FLOW - MECHANICAL POWER (8 poles)

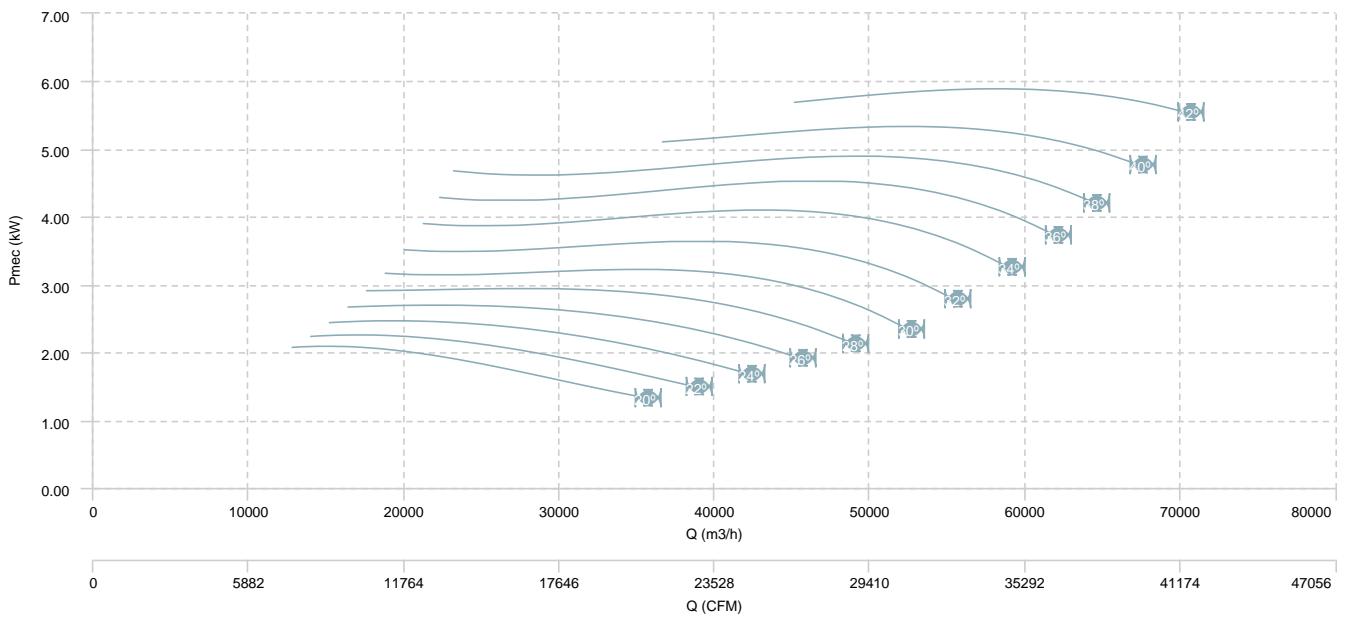



## Sound data

### Sound / 4 poles

Sound power Lw dB (A)										
Model		63 Hz	125 Hz	250 Hz	500 Hz	1000 Hz	2000 Hz	4000 Hz	8000 Hz	Total
HMFx 45 T4 (A5:6) F400 (20 <sup>o</sup> )	Inlet	44	50	56	65	61	63	65	59	70
HMFx 45 T4 (A5:6) F400 (25 <sup>o</sup> )	Inlet	46	51	58	65	64	65	67	59	72
HMFx 45 T4 (A5:6) F400 (27 <sup>o</sup> )	Inlet	47	52	59	65	65	66	67	59	72
HMFx 45 T4 (A5:6) F400 (30 <sup>o</sup> )	Inlet	49	54	61	65	67	68	69	60	74
HMFx 45 T4 (A5:6) F400 (33 <sup>o</sup> )	Inlet	50	54	62	64	67	68	69	60	74
HMFx 45 T4 (A5:6) F400 (35 <sup>o</sup> )	Inlet	50	54	62	63	68	68	70	59	74
HMFx 45 T4 (A5:6) F400 (37 <sup>o</sup> )	Inlet	52	55	64	65	69	69	71	61	76
HMFx 45 T4 (A5:6) F400 (40 <sup>o</sup> )	Inlet	53	57	65	67	70	70	72	63	77
HMFx 45 T4 (A5:6) F400 (43 <sup>o</sup> )	Inlet	53	57	65	67	71	71	73	64	77
HMFx 50 T4 (A5:6) F400 (25 <sup>o</sup> )	Inlet	45	52	57	62	65	67	69	61	73
HMFx 50 T4 (A5:6) F400 (27 <sup>o</sup> )	Inlet	46	53	58	63	66	68	70	62	74
HMFx 50 T4 (A5:6) F400 (30 <sup>o</sup> )	Inlet	48	53	60	64	67	68	71	62	75
HMFx 50 T4 (A5:6) F400 (33 <sup>o</sup> )	Inlet	49	54	61	66	69	70	72	63	76
HMFx 50 T4 (A5:6) F400 (35 <sup>o</sup> )	Inlet	50	55	62	68	70	71	73	64	78
HMFx 50 T4 (A5:6) F400 (37 <sup>o</sup> )	Inlet	50	57	62	68	70	71	73	64	78
HMFx 50 T4 (A5:6) F400 (40 <sup>o</sup> )	Inlet	50	57	62	68	70	71	73	64	78
HMFx 50 T4 (A5:6) F400 (43 <sup>o</sup> )	Inlet	53	60	65	72	73	73	76	67	80
HMFx 50 T4 (A5:6) F400 (45 <sup>o</sup> )	Inlet	53	60	65	73	74	74	76	68	81
HMFx 56 T4 (A5:6) F400 (20 <sup>o</sup> )	Inlet	66	73	78	79	80	78	76	68	86
HMFx 56 T4 (A5:6) F400 (25 <sup>o</sup> )	Inlet	53	62	67	73	75	75	76	67	82
HMFx 56 T4 (A5:6) F400 (30 <sup>o</sup> )	Inlet	62	72	79	81	81	79	77	69	87
HMFx 56 T4 (A5:6) F400 (35 <sup>o</sup> )	Inlet	50	62	67	73	74	75	76	68	81
HMFx 56 T4 (A5:6) F400 (40 <sup>o</sup> )	Inlet	56	69	79	85	84	78	76	67	89
HMFx 56 T4 (A5:6) F400 (45 <sup>o</sup> )	Inlet	60	73	88	94	91	80	76	67	96
HMFx 63 T4 (A5:6) F400 (20 <sup>o</sup> )	Inlet	69	76	81	82	83	80	79	72	89
HMFx 63 T4 (A5:6) F400 (25 <sup>o</sup> )	Inlet	54	63	68	73	77	76	76	70	83
HMFx 63 T4 (A5:6) F400 (30 <sup>o</sup> )	Inlet	57	65	75	82	80	79	79	72	87
HMFx 63 T4 (A5:6) F400 (35 <sup>o</sup> )	Inlet	53	65	70	74	78	77	79	72	84
HMFx 63 T4 (A5:6) F400 (40 <sup>o</sup> )	Inlet	54	66	77	89	86	81	79	71	92
HMFx 63 T4 (A5:6) F400 (45 <sup>o</sup> )	Inlet	55	66	82	100	92	84	79	71	100
HMFx 71 T4 (A5:6) F400 (20 <sup>o</sup> )	Inlet	71	78	83	85	85	83	82	75	92
HMFx 71 T4 (A5:6) F400 (25 <sup>o</sup> )	Inlet	58	68	74	78	81	82	82	73	88
HMFx 71 T4 (A5:6) F400 (30 <sup>o</sup> )	Inlet	60	68	75	81	82	81	81	72	87
HMFx 71 T4 (A5:6) F400 (35 <sup>o</sup> )	Inlet	53	65	70	75	78	79	80	71	84
HMFx 71 T4 (A5:6) F400 (40 <sup>o</sup> )	Inlet	57	68	83	92	88	83	81	72	95

Sound power Lw dB (A)										
Model		63 Hz	125 Hz	250 Hz	500 Hz	1000 Hz	2000 Hz	4000 Hz	8000 Hz	Total
HMFx 71 T4 (A5:6) F400 (45 <sup>o</sup> )	Inlet	61	70	92	105	96	87	83	72	105
HMFx 80 T4 (A5:6) F400 (20 <sup>o</sup> )	Inlet	74	81	86	88	88	86	85	78	94
HMFx 80 T4 (A5:6) F400 (25 <sup>o</sup> )	Inlet	61	68	74	79	81	81	82	74	88
HMFx 80 T4 (A5:6) F400 (30 <sup>o</sup> )	Inlet	61	72	79	89	87	85	85	77	93
HMFx 80 T4 (A5:6) F400 (35 <sup>o</sup> )	Inlet	58	70	76	84	89	87	87	78	94
HMFx 80 T4 (A5:6) F400 (40 <sup>o</sup> )	Inlet	59	72	88	93	90	86	84	76	97
HMFx 80 T4 (A5:6) F400 (45 <sup>o</sup> )	Inlet	60	74	97	100	91	86	82	75	102
HMFx 90 T4 (A3:4) F400 (20 <sup>o</sup> )	Inlet	83	84	82	87	88	87	85	79	94
HMFx 90 T4 (A3:4) F400 (22 <sup>o</sup> )	Inlet	87	85	83	86	87	86	85	78	94
HMFx 90 T4 (A3:4) F400 (24 <sup>o</sup> )	Inlet	89	86	84	86	86	85	84	78	95
HMFx 90 T4 (A3:4) F400 (26 <sup>o</sup> )	Inlet	90	87	85	86	85	84	83	77	95
HMFx 90 T4 (A3:4) F400 (28 <sup>o</sup> )	Inlet	91	88	86	86	84	83	83	77	95
HMFx 90 T4 (A3:4) F400 (30 <sup>o</sup> )	Inlet	92	89	87	86	83	82	82	76	96
HMFx 90 T4 (A3:4) F400 (32 <sup>o</sup> )	Inlet	92	89	87	85	83	82	82	76	96
HMFx 90 T4 (A3:4) F400 (34 <sup>o</sup> )	Inlet	91	88	86	84	83	83	81	75	95
HMFx 90 T4 (A3:4) F400 (36 <sup>o</sup> )	Inlet	92	89	87	84	84	83	81	75	96
HMFx 90 T4 (A3:4) F400 (38 <sup>o</sup> )	Inlet	93	90	88	85	85	83	82	77	97
HMFx 90 T4 (A3:4) F400 (40 <sup>o</sup> )	Inlet	94	91	89	86	87	84	83	78	98
HMFx 90 T4 (A3:4) F400 (42 <sup>o</sup> )	Inlet	95	92	90	87	88	85	84	79	99
HMFx 90 T4 (A3:8) F400 (20 <sup>o</sup> )	Inlet	95	97	99	94	93	86	87	79	104
HMFx 90 T4 (A3:8) F400 (22 <sup>o</sup> )	Inlet	95	96	97	93	92	86	87	79	103
HMFx 90 T4 (A3:8) F400 (24 <sup>o</sup> )	Inlet	95	95	95	92	91	87	87	79	102
HMFx 90 T4 (A3:8) F400 (26 <sup>o</sup> )	Inlet	96	94	93	91	90	87	87	80	101
HMFx 90 T4 (A3:8) F400 (28 <sup>o</sup> )	Inlet	96	92	91	90	89	87	86	80	100
HMFx 90 T4 (A3:8) F400 (30 <sup>o</sup> )	Inlet	94	91	89	89	88	87	86	80	99
HMFx 90 T4 (A3:8) F400 (32 <sup>o</sup> )	Inlet	93	90	88	88	87	86	85	79	98
HMFx 90 T4 (A3:8) F400 (34 <sup>o</sup> )	Inlet	93	90	88	87	87	86	84	78	97
HMFx 90 T4 (A3:8) F400 (36 <sup>o</sup> )	Inlet	93	90	88	86	87	86	84	78	97
HMFx 90 T4 (A3:8) F400 (38 <sup>o</sup> )	Inlet	95	92	90	87	87	86	83	78	99
HMFx 90 T4 (A3:8) F400 (40 <sup>o</sup> )	Inlet	97	94	92	87	88	86	83	79	100
HMFx 90 T4 (A3:8) F400 (42 <sup>o</sup> )	Inlet	97	94	92	88	88	87	84	79	101
HMFx 100 T4 (A3:4) F400 (20 <sup>o</sup> )	Inlet	66	76	81	88	91	92	93	90	98
HMFx 100 T4 (A3:4) F400 (22 <sup>o</sup> )	Inlet	66	76	82	88	91	92	93	90	98
HMFx 100 T4 (A3:4) F400 (24 <sup>o</sup> )	Inlet	67	76	81	87	91	92	93	89	98
HMFx 100 T4 (A3:4) F400 (26 <sup>o</sup> )	Inlet	67	75	81	87	90	91	93	88	97
HMFx 100 T4 (A3:4) F400 (28 <sup>o</sup> )	Inlet	67	75	81	86	90	91	93	87	97
HMFx 100 T4 (A3:4) F400 (30 <sup>o</sup> )	Inlet	68	74	81	86	90	91	93	86	97
HMFx 100 T4 (A3:4) F400 (32 <sup>o</sup> )	Inlet	68	74	81	86	89	90	92	86	96
HMFx 100 T4 (A3:4) F400 (34 <sup>o</sup> )	Inlet	69	73	81	85	88	90	91	85	96

Sound power Lw dB (A)										
Model		63 Hz	125 Hz	250 Hz	500 Hz	1000 Hz	2000 Hz	4000 Hz	8000 Hz	Total
HMFx 100 T4 (A3:4) F400 (36°)	Inlet	69	73	81	86	88	90	91	85	96
HMFx 100 T4 (A3:4) F400 (38°)	Inlet	68	74	81	86	89	90	92	85	96
HMFx 100 T4 (A3:4) F400 (40°)	Inlet	68	75	81	87	90	91	92	86	97
HMFx 100 T4 (A3:4) F400 (42°)	Inlet	69	77	83	88	92	92	93	87	98
HMFx 100 T4 (A3:8) F400 (20°)	Inlet	72	81	92	102	100	99	100	95	107
HMFx 100 T4 (A3:8) F400 (22°)	Inlet	72	80	91	100	99	98	99	94	106
HMFx 100 T4 (A3:8) F400 (24°)	Inlet	72	79	89	97	97	97	98	93	104
HMFx 100 T4 (A3:8) F400 (26°)	Inlet	72	79	88	95	96	96	97	92	103
HMFx 100 T4 (A3:8) F400 (28°)	Inlet	72	79	87	93	96	95	96	91	102
HMFx 100 T4 (A3:8) F400 (30°)	Inlet	72	79	86	91	95	95	96	90	101
HMFx 100 T4 (A3:8) F400 (32°)	Inlet	71	79	84	90	93	94	95	89	100
HMFx 100 T4 (A3:8) F400 (34°)	Inlet	71	78	83	88	92	93	94	88	99
HMFx 100 T4 (A3:8) F400 (36°)	Inlet	70	77	82	87	91	93	94	87	99
HMFx 100 T4 (A3:8) F400 (38°)	Inlet	71	78	83	88	92	94	94	88	99
HMFx 100 T4 (A3:8) F400 (40°)	Inlet	71	79	84	89	92	94	95	89	100
HMFx 100 T4 (A3:8) F400 (42°)	Inlet	72	79	84	89	93	94	95	89	100
HMFx 112 T4 (A3:4) F400 (20°)	Inlet	66	78	83	90	94	94	96	92	101
HMFx 112 T4 (A3:4) F400 (22°)	Inlet	68	79	84	90	94	95	96	92	102
HMFx 112 T4 (A3:4) F400 (24°)	Inlet	69	78	83	90	93	94	96	91	101
HMFx 112 T4 (A3:4) F400 (26°)	Inlet	70	78	83	89	93	94	95	90	100
HMFx 112 T4 (A3:4) F400 (28°)	Inlet	71	78	83	89	92	93	95	89	99
HMFx 112 T4 (A3:4) F400 (30°)	Inlet	71	78	83	88	92	93	94	88	99
HMFx 112 T4 (A3:4) F400 (32°)	Inlet	70	77	82	88	91	92	94	87	98
HMFx 112 T4 (A3:4) F400 (34°)	Inlet	70	76	82	87	90	92	93	86	98
HMFx 112 T4 (A3:4) F400 (36°)	Inlet	71	76	83	87	90	92	93	86	98
HMFx 112 T4 (A3:4) F400 (38°)	Inlet	71	77	83	88	91	92	93	87	98
HMFx 112 T4 (A3:4) F400 (40°)	Inlet	72	79	84	89	91	93	94	87	99
HMFx 112 T4 (A3:4) F400 (42°)	Inlet	72	79	84	89	92	94	94	88	99
HMFx 112 T4 (A3:8) F400 (20°)	Inlet	73	82	92	101	101	103	103	97	109
HMFx 112 T4 (A3:8) F400 (22°)	Inlet	73	81	91	99	100	102	102	96	107
HMFx 112 T4 (A3:8) F400 (24°)	Inlet	73	81	90	97	99	101	101	95	106
HMFx 112 T4 (A3:8) F400 (26°)	Inlet	74	81	89	96	98	100	100	94	106
HMFx 112 T4 (A3:8) F400 (28°)	Inlet	74	81	88	94	98	99	99	94	105
HMFx 112 T4 (A3:8) F400 (30°)	Inlet	74	80	87	93	97	99	99	93	104
HMFx 112 T4 (A3:8) F400 (32°)	Inlet	74	81	86	91	96	97	97	91	103
HMFx 112 T4 (A3:8) F400 (34°)	Inlet	73	80	85	90	94	96	96	89	101
HMFx 112 T4 (A3:8) F400 (36°)	Inlet	73	80	85	90	93	95	95	89	101
HMFx 112 T4 (A3:8) F400 (38°)	Inlet	73	80	85	90	94	96	95	89	101
HMFx 112 T4 (A3:8) F400 (40°)	Inlet	74	81	86	90	94	96	95	90	102

Sound power Lw dB (A)										
Model		63 Hz	125 Hz	250 Hz	500 Hz	1000 Hz	2000 Hz	4000 Hz	8000 Hz	Total
HMFx 112 T4 (A3:8) F400 (42 <sup>o</sup> )	Inlet	73	80	85	91	94	96	95	89	101
HMFx 125 T4 (A3:4) F400 (20 <sup>o</sup> )	Inlet	72	85	90	98	102	102	104	101	109
HMFx 125 T4 (A3:4) F400 (22 <sup>o</sup> )	Inlet	75	86	91	98	102	103	105	101	109
HMFx 125 T4 (A3:4) F400 (24 <sup>o</sup> )	Inlet	75	85	90	96	100	101	103	98	107
HMFx 125 T4 (A3:4) F400 (26 <sup>o</sup> )	Inlet	76	84	89	94	98	99	101	96	106
HMFx 125 T4 (A3:4) F400 (28 <sup>o</sup> )	Inlet	75	82	87	93	96	98	99	93	104
HMFx 125 T4 (A3:4) F400 (30 <sup>o</sup> )	Inlet	74	81	86	91	95	96	97	91	102
HMFx 125 T4 (A3:4) F400 (32 <sup>o</sup> )	Inlet	74	81	86	90	94	96	96	90	102
HMFx 125 T4 (A3:4) F400 (34 <sup>o</sup> )	Inlet	73	80	85	90	93	95	96	88	101
HMFx 125 T4 (A3:4) F400 (36 <sup>o</sup> )	Inlet	74	81	86	90	93	95	96	88	101
HMFx 125 T4 (A3:4) F400 (38 <sup>o</sup> )	Inlet	74	81	86	91	93	95	96	89	101
HMFx 125 T4 (A3:4) F400 (40 <sup>o</sup> )	Inlet	75	82	87	91	93	96	96	89	102
HMFx 125 T4 (A3:4) F400 (42 <sup>o</sup> )	Inlet	75	82	87	92	94	96	96	90	102
HMFx 125 T4 (A3:8) F400 (20 <sup>o</sup> )	Inlet	78	86	93	103	108	111	110	105	115
HMFx 125 T4 (A3:8) F400 (22 <sup>o</sup> )	Inlet	79	86	93	102	107	110	109	104	114
HMFx 125 T4 (A3:8) F400 (24 <sup>o</sup> )	Inlet	78	85	92	100	106	108	108	102	113
HMFx 125 T4 (A3:8) F400 (26 <sup>o</sup> )	Inlet	78	85	91	98	104	106	106	100	111
HMFx 125 T4 (A3:8) F400 (28 <sup>o</sup> )	Inlet	78	84	91	97	102	105	105	98	110
HMFx 125 T4 (A3:8) F400 (30 <sup>o</sup> )	Inlet	77	83	90	96	101	103	104	97	108
HMFx 125 T4 (A3:8) F400 (32 <sup>o</sup> )	Inlet	77	83	89	95	99	102	102	94	107
HMFx 125 T4 (A3:8) F400 (34 <sup>o</sup> )	Inlet	77	83	89	94	97	99	100	92	105
HMFx 125 T4 (A3:8) F400 (36 <sup>o</sup> )	Inlet	77	83	89	93	96	98	98	91	104
HMFx 125 T4 (A3:8) F400 (38 <sup>o</sup> )	Inlet	76	83	88	93	96	98	97	91	104
HMFx 125 T4 (A3:8) F400 (40 <sup>o</sup> )	Inlet	76	83	88	93	96	98	97	90	103
HMFx 125 T4 (A3:8) F400 (42 <sup>o</sup> )	Inlet	76	83	88	93	96	98	96	90	103

**Sound / 6 poles**

Sound power Lw dB (A)										
Model		63 Hz	125 Hz	250 Hz	500 Hz	1000 Hz	2000 Hz	4000 Hz	8000 Hz	Total
HMFx 45 T6 (A5:6) F400 (25 <sup>o</sup> )	Inlet	37	42	49	55	54	55	57	50	62
HMFx 45 T6 (A5:6) F400 (27 <sup>o</sup> )	Inlet	38	43	50	55	55	56	58	50	63
HMFx 45 T6 (A5:6) F400 (30 <sup>o</sup> )	Inlet	40	44	52	55	57	58	59	50	64
HMFx 45 T6 (A5:6) F400 (33 <sup>o</sup> )	Inlet	40	44	52	55	58	58	60	50	65
HMFx 45 T6 (A5:6) F400 (35 <sup>o</sup> )	Inlet	41	45	53	54	59	59	60	50	65
HMFx 45 T6 (A5:6) F400 (37 <sup>o</sup> )	Inlet	42	46	54	56	60	60	61	52	66
HMFx 45 T6 (A5:6) F400 (40 <sup>o</sup> )	Inlet	44	47	56	57	61	61	63	54	67
HMFx 45 T6 (A5:6) F400 (43 <sup>o</sup> )	Inlet	43	47	55	58	62	62	63	55	68

Sound power Lw dB (A)										
Model		63 Hz	125 Hz	250 Hz	500 Hz	1000 Hz	2000 Hz	4000 Hz	8000 Hz	Total
HMFx 45 T6 (A5:6) F400 (45°)	Inlet	43	47	55	58	62	62	63	55	68
HMFx 50 T6 (A5:6) F400 (25°)	Inlet	36	43	48	53	55	58	60	52	64
HMFx 50 T6 (A5:6) F400 (27°)	Inlet	37	43	49	53	56	58	61	52	64
HMFx 50 T6 (A5:6) F400 (30°)	Inlet	39	44	51	55	58	59	62	53	66
HMFx 50 T6 (A5:6) F400 (33°)	Inlet	40	45	52	57	59	60	63	54	67
HMFx 50 T6 (A5:6) F400 (35°)	Inlet	40	45	52	59	61	62	64	55	68
HMFx 50 T6 (A5:6) F400 (37°)	Inlet	41	48	53	59	61	62	64	55	68
HMFx 50 T6 (A5:6) F400 (40°)	Inlet	41	48	53	59	61	62	64	55	68
HMFx 50 T6 (A5:6) F400 (43°)	Inlet	43	50	55	62	63	64	66	58	71
HMFx 50 T6 (A5:6) F400 (45°)	Inlet	44	51	56	64	65	65	67	59	72
HMFx 56 T6 (A5:6) F400 (20°)	Inlet	63	70	75	76	77	75	73	65	82
HMFx 56 T6 (A5:6) F400 (25°)	Inlet	50	59	64	70	72	72	73	64	78
HMFx 56 T6 (A5:6) F400 (30°)	Inlet	58	68	75	77	78	76	74	66	83
HMFx 56 T6 (A5:6) F400 (35°)	Inlet	47	58	63	69	70	71	72	64	78
HMFx 56 T6 (A5:6) F400 (40°)	Inlet	53	66	76	81	81	75	73	64	85
HMFx 56 T6 (A5:6) F400 (45°)	Inlet	57	69	84	90	88	77	73	63	93
HMFx 63 T6 (A5:6) F400 (20°)	Inlet	66	73	78	79	80	77	76	69	85
HMFx 63 T6 (A5:6) F400 (25°)	Inlet	51	60	65	70	74	73	73	67	79
HMFx 63 T6 (A5:6) F400 (30°)	Inlet	54	62	72	79	77	76	76	69	83
HMFx 63 T6 (A5:6) F400 (35°)	Inlet	50	62	67	71	75	74	76	69	81
HMFx 63 T6 (A5:6) F400 (40°)	Inlet	51	63	74	86	83	78	76	68	88
HMFx 63 T6 (A5:6) F400 (45°)	Inlet	52	63	79	96	88	81	76	67	97
HMFx 71 T6 (A5:6) F400 (20°)	Inlet	68	75	80	82	82	80	79	72	88
HMFx 71 T6 (A5:6) F400 (25°)	Inlet	55	65	71	75	78	79	79	70	84
HMFx 71 T6 (A5:6) F400 (30°)	Inlet	57	65	71	77	78	78	77	68	84
HMFx 71 T6 (A5:6) F400 (35°)	Inlet	49	61	66	71	74	75	76	67	81
HMFx 71 T6 (A5:6) F400 (40°)	Inlet	54	64	79	89	85	80	78	68	91
HMFx 71 T6 (A5:6) F400 (45°)	Inlet	57	66	88	101	92	83	79	69	102
HMFx 80 T6 (A5:6) F400 (20°)	Inlet	71	78	83	85	85	83	82	75	91
HMFx 80 T6 (A5:6) F400 (25°)	Inlet	58	65	71	76	78	78	79	71	84
HMFx 80 T6 (A5:6) F400 (30°)	Inlet	58	69	76	86	84	82	82	74	90
HMFx 80 T6 (A5:6) F400 (35°)	Inlet	55	67	73	81	86	84	84	75	90
HMFx 80 T6 (A5:6) F400 (40°)	Inlet	56	69	85	90	87	83	81	73	93
HMFx 80 T6 (A5:6) F400 (45°)	Inlet	56	70	93	96	87	82	79	71	98
HMFx 90 T6 (A3:4) F400 (20°)	Inlet	73	74	72	77	78	77	76	70	85
HMFx 90 T6 (A3:4) F400 (22°)	Inlet	77	76	74	77	77	76	75	69	85
HMFx 90 T6 (A3:4) F400 (24°)	Inlet	80	77	75	77	76	75	75	68	85
HMFx 90 T6 (A3:4) F400 (26°)	Inlet	81	78	76	77	75	74	74	68	85
HMFx 90 T6 (A3:4) F400 (28°)	Inlet	82	79	77	76	74	73	73	67	86

Sound power Lw dB (A)											
Model		63 Hz	125 Hz	250 Hz	500 Hz	1000 Hz	2000 Hz	4000 Hz	8000 Hz	Total	
HMFx 90 T6 (A3:4) F400 (30 <sup>o</sup> )	Inlet	83	80	78	76	73	72	73	67	87	
HMFx 90 T6 (A3:4) F400 (32 <sup>o</sup> )	Inlet	83	80	78	76	74	73	72	66	86	
HMFx 90 T6 (A3:4) F400 (34 <sup>o</sup> )	Inlet	82	79	77	75	74	73	72	66	86	
HMFx 90 T6 (A3:4) F400 (36 <sup>o</sup> )	Inlet	82	79	77	75	75	74	72	66	86	
HMFx 90 T6 (A3:4) F400 (38 <sup>o</sup> )	Inlet	84	81	79	76	76	74	73	67	87	
HMFx 90 T6 (A3:4) F400 (40 <sup>o</sup> )	Inlet	85	82	80	76	77	74	73	68	88	
HMFx 90 T6 (A3:4) F400 (42 <sup>o</sup> )	Inlet	86	83	81	77	79	75	74	69	89	
HMFx 90 T6 (A3:8) F400 (20 <sup>o</sup> )	Inlet	86	88	90	85	84	77	78	70	94	
HMFx 90 T6 (A3:8) F400 (22 <sup>o</sup> )	Inlet	86	87	88	84	83	77	78	70	93	
HMFx 90 T6 (A3:8) F400 (24 <sup>o</sup> )	Inlet	86	85	86	83	82	77	77	70	92	
HMFx 90 T6 (A3:8) F400 (26 <sup>o</sup> )	Inlet	86	84	84	82	81	77	77	70	91	
HMFx 90 T6 (A3:8) F400 (28 <sup>o</sup> )	Inlet	86	83	82	81	80	77	77	71	90	
HMFx 90 T6 (A3:8) F400 (30 <sup>o</sup> )	Inlet	85	82	80	80	79	78	77	71	89	
HMFx 90 T6 (A3:8) F400 (32 <sup>o</sup> )	Inlet	84	81	79	79	78	77	76	70	88	
HMFx 90 T6 (A3:8) F400 (34 <sup>o</sup> )	Inlet	83	80	78	77	77	77	75	69	88	
HMFx 90 T6 (A3:8) F400 (36 <sup>o</sup> )	Inlet	84	81	79	77	77	76	74	69	88	
HMFx 90 T6 (A3:8) F400 (38 <sup>o</sup> )	Inlet	85	82	80	77	78	77	74	69	89	
HMFx 90 T6 (A3:8) F400 (40 <sup>o</sup> )	Inlet	87	84	82	78	79	77	74	69	91	
HMFx 90 T6 (A3:8) F400 (42 <sup>o</sup> )	Inlet	87	84	82	78	79	77	74	69	91	
HMFx 100 T6 (A3:4) F400 (20 <sup>o</sup> )	Inlet	56	67	72	78	82	83	84	81	89	
HMFx 100 T6 (A3:4) F400 (22 <sup>o</sup> )	Inlet	57	67	72	78	82	83	84	80	89	
HMFx 100 T6 (A3:4) F400 (24 <sup>o</sup> )	Inlet	57	66	72	78	82	82	84	79	89	
HMFx 100 T6 (A3:4) F400 (26 <sup>o</sup> )	Inlet	57	66	71	77	81	82	83	78	88	
HMFx 100 T6 (A3:4) F400 (28 <sup>o</sup> )	Inlet	58	65	71	77	81	81	83	78	88	
HMFx 100 T6 (A3:4) F400 (30 <sup>o</sup> )	Inlet	58	65	71	77	80	81	83	77	87	
HMFx 100 T6 (A3:4) F400 (32 <sup>o</sup> )	Inlet	59	64	71	76	79	81	83	76	87	
HMFx 100 T6 (A3:4) F400 (34 <sup>o</sup> )	Inlet	59	63	71	76	79	80	82	76	86	
HMFx 100 T6 (A3:4) F400 (36 <sup>o</sup> )	Inlet	59	64	71	76	79	80	82	76	86	
HMFx 100 T6 (A3:4) F400 (38 <sup>o</sup> )	Inlet	59	65	72	77	80	81	82	76	87	
HMFx 100 T6 (A3:4) F400 (40 <sup>o</sup> )	Inlet	59	66	72	77	81	81	83	76	87	
HMFx 100 T6 (A3:4) F400 (42 <sup>o</sup> )	Inlet	60	67	73	79	82	82	83	78	89	
HMFx 100 T6 (A3:8) F400 (20 <sup>o</sup> )	Inlet	63	71	83	92	91	89	90	86	97	
HMFx 100 T6 (A3:8) F400 (22 <sup>o</sup> )	Inlet	63	71	82	90	89	88	89	85	96	
HMFx 100 T6 (A3:8) F400 (24 <sup>o</sup> )	Inlet	62	70	80	88	88	87	88	83	94	
HMFx 100 T6 (A3:8) F400 (26 <sup>o</sup> )	Inlet	62	70	79	86	87	87	87	82	93	
HMFx 100 T6 (A3:8) F400 (28 <sup>o</sup> )	Inlet	62	70	78	84	86	86	87	81	92	
HMFx 100 T6 (A3:8) F400 (30 <sup>o</sup> )	Inlet	62	69	77	82	85	86	86	80	92	
HMFx 100 T6 (A3:8) F400 (32 <sup>o</sup> )	Inlet	62	69	75	80	84	85	85	79	90	
HMFx 100 T6 (A3:8) F400 (34 <sup>o</sup> )	Inlet	61	68	73	78	82	84	85	78	89	

Sound power Lw dB (A)										
Model		63 Hz	125 Hz	250 Hz	500 Hz	1000 Hz	2000 Hz	4000 Hz	8000 Hz	Total
HMFx 100 T6 (A3:8) F400 (36 <sup>o</sup> )	Inlet	61	68	73	78	82	84	84	78	89
HMFx 100 T6 (A3:8) F400 (38 <sup>o</sup> )	Inlet	61	68	73	79	82	84	85	79	90
HMFx 100 T6 (A3:8) F400 (40 <sup>o</sup> )	Inlet	62	69	74	79	83	85	85	79	90
HMFx 100 T6 (A3:8) F400 (42 <sup>o</sup> )	Inlet	62	69	74	80	83	85	85	79	90
HMFx 112 T6 (A3:4) F400 (20 <sup>o</sup> )	Inlet	56	68	73	80	84	85	87	82	91
HMFx 112 T6 (A3:4) F400 (22 <sup>o</sup> )	Inlet	58	69	74	81	85	85	87	82	92
HMFx 112 T6 (A3:4) F400 (24 <sup>o</sup> )	Inlet	59	69	74	80	84	85	86	81	91
HMFx 112 T6 (A3:4) F400 (26 <sup>o</sup> )	Inlet	60	69	74	80	83	84	86	80	90
HMFx 112 T6 (A3:4) F400 (28 <sup>o</sup> )	Inlet	61	69	74	79	83	84	85	79	90
HMFx 112 T6 (A3:4) F400 (30 <sup>o</sup> )	Inlet	61	68	73	79	82	83	85	78	89
HMFx 112 T6 (A3:4) F400 (32 <sup>o</sup> )	Inlet	61	67	73	78	81	83	84	78	89
HMFx 112 T6 (A3:4) F400 (34 <sup>o</sup> )	Inlet	61	66	73	78	81	82	84	77	88
HMFx 112 T6 (A3:4) F400 (36 <sup>o</sup> )	Inlet	61	67	73	78	81	82	84	77	88
HMFx 112 T6 (A3:4) F400 (38 <sup>o</sup> )	Inlet	62	68	74	78	81	83	84	77	89
HMFx 112 T6 (A3:4) F400 (40 <sup>o</sup> )	Inlet	63	69	75	79	82	84	84	78	89
HMFx 112 T6 (A3:4) F400 (42 <sup>o</sup> )	Inlet	63	70	75	80	83	84	85	78	90
HMFx 112 T6 (A3:8) F400 (20 <sup>o</sup> )	Inlet	64	72	82	91	91	93	93	88	99
HMFx 112 T6 (A3:8) F400 (22 <sup>o</sup> )	Inlet	64	72	81	89	90	92	92	87	98
HMFx 112 T6 (A3:8) F400 (24 <sup>o</sup> )	Inlet	64	71	80	88	90	91	91	86	96
HMFx 112 T6 (A3:8) F400 (26 <sup>o</sup> )	Inlet	64	71	79	86	89	90	90	85	96
HMFx 112 T6 (A3:8) F400 (28 <sup>o</sup> )	Inlet	64	71	79	85	89	90	90	84	95
HMFx 112 T6 (A3:8) F400 (30 <sup>o</sup> )	Inlet	65	71	78	83	88	89	89	84	94
HMFx 112 T6 (A3:8) F400 (32 <sup>o</sup> )	Inlet	64	71	77	82	86	88	88	82	93
HMFx 112 T6 (A3:8) F400 (34 <sup>o</sup> )	Inlet	64	71	76	81	84	86	87	80	92
HMFx 112 T6 (A3:8) F400 (36 <sup>o</sup> )	Inlet	63	70	75	80	84	86	86	79	91
HMFx 112 T6 (A3:8) F400 (38 <sup>o</sup> )	Inlet	64	71	76	81	84	86	86	80	91
HMFx 112 T6 (A3:8) F400 (40 <sup>o</sup> )	Inlet	64	71	76	81	85	87	86	80	92
HMFx 112 T6 (A3:8) F400 (42 <sup>o</sup> )	Inlet	64	71	76	81	85	86	86	79	91
HMFx 125 T6 (A3:4) F400 (20 <sup>o</sup> )	Inlet	63	76	81	89	92	92	94	91	99
HMFx 125 T6 (A3:4) F400 (22 <sup>o</sup> )	Inlet	65	77	82	89	92	93	95	91	99
HMFx 125 T6 (A3:4) F400 (24 <sup>o</sup> )	Inlet	66	75	80	87	90	91	93	88	98
HMFx 125 T6 (A3:4) F400 (26 <sup>o</sup> )	Inlet	66	74	79	85	89	90	91	86	96
HMFx 125 T6 (A3:4) F400 (28 <sup>o</sup> )	Inlet	66	73	78	83	87	88	89	84	94
HMFx 125 T6 (A3:4) F400 (30 <sup>o</sup> )	Inlet	65	72	77	81	85	87	88	81	92
HMFx 125 T6 (A3:4) F400 (32 <sup>o</sup> )	Inlet	64	71	76	81	84	86	87	80	92
HMFx 125 T6 (A3:4) F400 (34 <sup>o</sup> )	Inlet	64	71	76	81	84	85	86	79	91
HMFx 125 T6 (A3:4) F400 (36 <sup>o</sup> )	Inlet	64	71	76	81	83	85	86	79	91
HMFx 125 T6 (A3:4) F400 (38 <sup>o</sup> )	Inlet	65	72	77	81	84	86	86	79	91
HMFx 125 T6 (A3:4) F400 (40 <sup>o</sup> )	Inlet	65	72	77	82	84	86	87	80	92



Sound power Lw dB (A)										
Model		63 Hz	125 Hz	250 Hz	500 Hz	1000 Hz	2000 Hz	4000 Hz	8000 Hz	Total
HMFx 125 T6 (A3:4) F400 (42 <sup>o</sup> )	Inlet	66	73	78	82	85	87	87	81	92
HMFx 125 T6 (A3:8) F400 (20 <sup>o</sup> )	Inlet	69	77	84	93	98	101	101	95	106
HMFx 125 T6 (A3:8) F400 (22 <sup>o</sup> )	Inlet	69	77	84	92	97	100	99	94	105
HMFx 125 T6 (A3:8) F400 (24 <sup>o</sup> )	Inlet	69	76	83	90	96	98	98	92	103
HMFx 125 T6 (A3:8) F400 (26 <sup>o</sup> )	Inlet	69	75	82	89	94	97	96	90	102
HMFx 125 T6 (A3:8) F400 (28 <sup>o</sup> )	Inlet	68	74	81	87	93	95	95	89	100
HMFx 125 T6 (A3:8) F400 (30 <sup>o</sup> )	Inlet	68	74	80	86	91	93	94	87	98
HMFx 125 T6 (A3:8) F400 (32 <sup>o</sup> )	Inlet	68	74	80	85	90	92	92	85	97
HMFx 125 T6 (A3:8) F400 (34 <sup>o</sup> )	Inlet	68	74	80	84	88	90	90	83	95
HMFx 125 T6 (A3:8) F400 (36 <sup>o</sup> )	Inlet	67	74	79	84	87	89	89	82	94
HMFx 125 T6 (A3:8) F400 (38 <sup>o</sup> )	Inlet	67	74	79	84	87	89	88	81	94
HMFx 125 T6 (A3:8) F400 (40 <sup>o</sup> )	Inlet	67	74	79	83	87	89	87	81	93
HMFx 125 T6 (A3:8) F400 (42 <sup>o</sup> )	Inlet	67	74	79	84	87	88	87	81	93

## Sound / 4/6 poles

Sound power Lw dB (A)										
Model		63 Hz	125 Hz	250 Hz	500 Hz	1000 Hz	2000 Hz	4000 Hz	8000 Hz	Total
HMFx 56 T4/T6 (A5:6) F400 (1000 RPM - 20 <sup>o</sup> )	Inlet	57	64	69	70	71	69	67	59	77
HMFx 56 T4/T6 (A5:6) F400 (1000 RPM - 25 <sup>o</sup> )	Inlet	44	53	58	64	66	66	67	58	72
HMFx 56 T4/T6 (A5:6) F400 (1000 RPM - 30 <sup>o</sup> )	Inlet	53	63	70	72	72	70	68	60	78
HMFx 56 T4/T6 (A5:6) F400 (1000 RPM - 35 <sup>o</sup> )	Inlet	41	53	58	64	65	66	67	59	72
HMFx 56 T4/T6 (A5:6) F400 (1000 RPM - 40 <sup>o</sup> )	Inlet	47	60	70	76	75	69	67	58	80
HMFx 56 T4/T6 (A5:6) F400 (1000 RPM - 45 <sup>o</sup> )	Inlet	51	64	79	84	82	71	67	57	87
HMFx 56 T4/T6 (A5:6) F400 (1500 RPM - 20 <sup>o</sup> )	Inlet	66	73	78	79	80	78	76	68	86
HMFx 56 T4/T6 (A5:6) F400 (1500 RPM - 25 <sup>o</sup> )	Inlet	53	62	67	73	75	75	76	67	82
HMFx 56 T4/T6 (A5:6) F400 (1500 RPM - 30 <sup>o</sup> )	Inlet	62	72	79	81	81	79	77	69	87
HMFx 56 T4/T6 (A5:6) F400 (1500 RPM - 35 <sup>o</sup> )	Inlet	50	62	67	73	74	75	76	68	81
HMFx 56 T4/T6 (A5:6) F400 (1500 RPM - 40 <sup>o</sup> )	Inlet	56	69	79	85	84	78	76	67	89



Sound power Lw dB (A)										
Model		63 Hz	125 Hz	250 Hz	500 Hz	1000 Hz	2000 Hz	4000 Hz	8000 Hz	Total
HMFx 56 T4/T6 (A5:6) F400 (1500 RPM - 45°)	Inlet	60	73	88	94	91	80	76	67	96
HMFx 63 T4/T6 (A5:6) F400 (1000 RPM - 20°)	Inlet	60	67	72	73	74	71	70	63	80
HMFx 63 T4/T6 (A5:6) F400 (1000 RPM - 25°)	Inlet	45	54	59	64	68	67	67	61	73
HMFx 63 T4/T6 (A5:6) F400 (1000 RPM - 30°)	Inlet	48	56	66	73	71	70	70	63	78
HMFx 63 T4/T6 (A5:6) F400 (1000 RPM - 35°)	Inlet	44	56	61	65	69	68	70	63	75
HMFx 63 T4/T6 (A5:6) F400 (1000 RPM - 40°)	Inlet	45	57	68	80	77	72	70	62	83
HMFx 63 T4/T6 (A5:6) F400 (1000 RPM - 45°)	Inlet	46	57	73	90	83	75	70	61	91
HMFx 63 T4/T6 (A5:6) F400 (1500 RPM - 20°)	Inlet	69	76	81	82	83	80	79	72	89
HMFx 63 T4/T6 (A5:6) F400 (1500 RPM - 25°)	Inlet	54	63	68	73	77	76	76	70	83
HMFx 63 T4/T6 (A5:6) F400 (1500 RPM - 30°)	Inlet	57	65	75	82	80	79	79	72	87
HMFx 63 T4/T6 (A5:6) F400 (1500 RPM - 35°)	Inlet	53	65	70	74	78	77	79	72	84
HMFx 63 T4/T6 (A5:6) F400 (1500 RPM - 40°)	Inlet	54	66	77	89	86	81	79	71	92
HMFx 63 T4/T6 (A5:6) F400 (1500 RPM - 45°)	Inlet	55	66	82	100	92	84	79	71	100
HMFx 71 T4/T6 (A5:6) F400 (1000 RPM - 20°)	Inlet	62	69	74	76	76	74	73	66	82
HMFx 71 T4/T6 (A5:6) F400 (1000 RPM - 25°)	Inlet	49	59	65	69	72	73	73	64	78
HMFx 71 T4/T6 (A5:6) F400 (1000 RPM - 30°)	Inlet	51	59	65	71	72	72	71	62	78
HMFx 71 T4/T6 (A5:6) F400 (1000 RPM - 35°)	Inlet	43	55	60	65	69	69	70	61	75
HMFx 71 T4/T6 (A5:6) F400 (1000 RPM - 40°)	Inlet	48	58	73	83	79	74	72	62	85
HMFx 71 T4/T6 (A5:6) F400 (1000 RPM - 45°)	Inlet	51	60	82	95	86	77	73	63	96
HMFx 71 T4/T6 (A5:6) F400 (1500 RPM - 20°)	Inlet	71	78	83	85	85	83	82	75	92
HMFx 71 T4/T6 (A5:6) F400 (1500 RPM - 25°)	Inlet	58	68	74	78	81	82	82	73	88
HMFx 71 T4/T6 (A5:6) F400 (1500 RPM - 30°)	Inlet	60	68	75	81	82	81	81	72	87

Sound power Lw dB (A)										
Model		63 Hz	125 Hz	250 Hz	500 Hz	1000 Hz	2000 Hz	4000 Hz	8000 Hz	Total
HMFx 71 T4/T6 (A5:6) F400 (1500 RPM - 35°)	Inlet	53	65	70	75	78	79	80	71	84
HMFx 71 T4/T6 (A5:6) F400 (1500 RPM - 40°)	Inlet	57	68	83	92	88	83	81	72	95
HMFx 71 T4/T6 (A5:6) F400 (1500 RPM - 45°)	Inlet	61	70	92	105	96	87	83	72	105
HMFx 80 T4/T6 (A5:6) F400 (1000 RPM - 20°)	Inlet	65	72	77	79	79	77	76	69	85
HMFx 80 T4/T6 (A5:6) F400 (1000 RPM - 25°)	Inlet	52	59	65	70	72	72	73	65	78
HMFx 80 T4/T6 (A5:6) F400 (1000 RPM - 30°)	Inlet	52	63	70	80	78	76	76	68	84
HMFx 80 T4/T6 (A5:6) F400 (1000 RPM - 35°)	Inlet	49	61	67	75	80	78	78	69	84
HMFx 80 T4/T6 (A5:6) F400 (1000 RPM - 40°)	Inlet	50	63	79	84	81	77	75	67	87
HMFx 80 T4/T6 (A5:6) F400 (1000 RPM - 45°)	Inlet	51	64	87	90	82	76	73	66	93
HMFx 80 T4/T6 (A5:6) F400 (1500 RPM - 20°)	Inlet	74	81	86	88	88	86	85	78	94
HMFx 80 T4/T6 (A5:6) F400 (1500 RPM - 25°)	Inlet	61	68	74	79	81	81	82	74	88
HMFx 80 T4/T6 (A5:6) F400 (1500 RPM - 30°)	Inlet	61	72	79	89	87	85	85	77	93
HMFx 80 T4/T6 (A5:6) F400 (1500 RPM - 35°)	Inlet	58	70	76	84	89	87	87	78	94
HMFx 80 T4/T6 (A5:6) F400 (1500 RPM - 40°)	Inlet	59	72	88	93	90	86	84	76	97
HMFx 80 T4/T6 (A5:6) F400 (1500 RPM - 45°)	Inlet	60	74	97	100	91	86	82	75	102
HMFx 90 T4/T6 (A3:4) F400 (1000 RPM - 20°)	Inlet	73	75	73	77	78	77	76	70	85
HMFx 90 T4/T6 (A3:4) F400 (1000 RPM - 22°)	Inlet	77	76	74	77	77	76	75	69	85
HMFx 90 T4/T6 (A3:4) F400 (1000 RPM - 24°)	Inlet	80	77	75	77	76	75	75	69	85
HMFx 90 T4/T6 (A3:4) F400 (1000 RPM - 26°)	Inlet	81	78	76	77	75	74	74	68	86
HMFx 90 T4/T6 (A3:4) F400 (1000 RPM - 28°)	Inlet	82	79	77	76	74	73	73	68	86
HMFx 90 T4/T6 (A3:4) F400 (1000 RPM - 30°)	Inlet	83	80	78	76	73	72	73	67	87
HMFx 90 T4/T6 (A3:4) F400 (1000 RPM - 32°)	Inlet	83	80	78	76	74	73	72	66	86

Sound power Lw dB (A)										
Model		63 Hz	125 Hz	250 Hz	500 Hz	1000 Hz	2000 Hz	4000 Hz	8000 Hz	Total
HMFx 90 T4/T6 (A3:4) F400 (1000 RPM - 34°)	Inlet	82	79	77	75	74	73	72	66	86
HMFx 90 T4/T6 (A3:4) F400 (1000 RPM - 36°)	Inlet	83	80	78	75	75	74	72	66	86
HMFx 90 T4/T6 (A3:4) F400 (1000 RPM - 38°)	Inlet	84	81	79	76	76	74	73	67	87
HMFx 90 T4/T6 (A3:4) F400 (1000 RPM - 40°)	Inlet	85	82	80	76	77	74	73	68	88
HMFx 90 T4/T6 (A3:4) F400 (1000 RPM - 42°)	Inlet	86	83	81	78	79	76	74	70	90
HMFx 90 T4/T6 (A3:4) F400 (1500 RPM - 20°)	Inlet	83	84	82	87	88	87	85	79	94
HMFx 90 T4/T6 (A3:4) F400 (1500 RPM - 22°)	Inlet	87	85	83	86	87	86	85	78	94
HMFx 90 T4/T6 (A3:4) F400 (1500 RPM - 24°)	Inlet	89	86	84	86	86	85	84	78	95
HMFx 90 T4/T6 (A3:4) F400 (1500 RPM - 26°)	Inlet	90	87	85	86	85	84	83	77	95
HMFx 90 T4/T6 (A3:4) F400 (1500 RPM - 28°)	Inlet	91	88	86	86	84	83	83	77	95
HMFx 90 T4/T6 (A3:4) F400 (1500 RPM - 30°)	Inlet	92	89	87	86	83	82	82	76	96
HMFx 90 T4/T6 (A3:4) F400 (1500 RPM - 32°)	Inlet	92	89	87	85	83	82	82	76	96
HMFx 90 T4/T6 (A3:4) F400 (1500 RPM - 34°)	Inlet	91	88	86	84	83	83	81	75	95
HMFx 90 T4/T6 (A3:4) F400 (1500 RPM - 36°)	Inlet	92	89	87	84	84	83	81	75	96
HMFx 90 T4/T6 (A3:4) F400 (1500 RPM - 38°)	Inlet	93	90	88	85	85	83	82	77	97
HMFx 90 T4/T6 (A3:4) F400 (1500 RPM - 40°)	Inlet	94	91	89	86	87	84	83	78	98
HMFx 90 T4/T6 (A3:4) F400 (1500 RPM - 42°)	Inlet	95	92	90	87	88	85	84	79	99
HMFx 90 T4/T6 (A3:8) F400 (1000 RPM - 20°)	Inlet	86	88	90	85	84	77	78	70	94
HMFx 90 T4/T6 (A3:8) F400 (1000 RPM - 22°)	Inlet	86	87	88	84	83	77	78	70	93
HMFx 90 T4/T6 (A3:8) F400 (1000 RPM - 24°)	Inlet	86	85	86	83	82	77	77	70	92
HMFx 90 T4/T6 (A3:8) F400 (1000 RPM - 26°)	Inlet	86	84	84	82	81	77	77	70	91
HMFx 90 T4/T6 (A3:8) F400 (1000 RPM - 28°)	Inlet	86	83	82	81	80	78	77	71	90

Sound power Lw dB (A)										
Model		63 Hz	125 Hz	250 Hz	500 Hz	1000 Hz	2000 Hz	4000 Hz	8000 Hz	Total
HMFx 90 T4/T6 (A3:8) F400 (1000 RPM - 30°)	Inlet	85	82	80	80	79	78	77	71	89
HMFx 90 T4/T6 (A3:8) F400 (1000 RPM - 32°)	Inlet	84	81	79	79	78	77	76	70	89
HMFx 90 T4/T6 (A3:8) F400 (1000 RPM - 34°)	Inlet	83	80	78	78	77	77	75	69	88
HMFx 90 T4/T6 (A3:8) F400 (1000 RPM - 36°)	Inlet	84	81	79	77	77	76	74	69	88
HMFx 90 T4/T6 (A3:8) F400 (1000 RPM - 38°)	Inlet	86	83	81	77	78	77	74	69	89
HMFx 90 T4/T6 (A3:8) F400 (1000 RPM - 40°)	Inlet	87	84	82	78	79	77	74	69	90
HMFx 90 T4/T6 (A3:8) F400 (1000 RPM - 42°)	Inlet	87	84	82	78	79	78	74	70	91
HMFx 90 T4/T6 (A3:8) F400 (1500 RPM - 20°)	Inlet	95	97	99	94	93	86	87	79	104
HMFx 90 T4/T6 (A3:8) F400 (1500 RPM - 22°)	Inlet	95	96	97	93	92	86	87	79	103
HMFx 90 T4/T6 (A3:8) F400 (1500 RPM - 24°)	Inlet	95	95	95	92	91	87	87	79	102
HMFx 90 T4/T6 (A3:8) F400 (1500 RPM - 26°)	Inlet	96	94	93	91	90	87	87	80	101
HMFx 90 T4/T6 (A3:8) F400 (1500 RPM - 28°)	Inlet	96	92	91	90	89	87	86	80	100
HMFx 90 T4/T6 (A3:8) F400 (1500 RPM - 30°)	Inlet	94	91	89	89	88	87	86	80	99
HMFx 90 T4/T6 (A3:8) F400 (1500 RPM - 32°)	Inlet	93	90	88	88	87	86	85	79	98
HMFx 90 T4/T6 (A3:8) F400 (1500 RPM - 34°)	Inlet	93	90	88	87	87	86	84	78	97
HMFx 90 T4/T6 (A3:8) F400 (1500 RPM - 36°)	Inlet	93	90	88	86	87	86	84	78	97
HMFx 90 T4/T6 (A3:8) F400 (1500 RPM - 38°)	Inlet	95	92	90	87	87	86	83	78	99
HMFx 90 T4/T6 (A3:8) F400 (1500 RPM - 40°)	Inlet	97	94	92	87	88	86	83	79	100
HMFx 90 T4/T6 (A3:8) F400 (1500 RPM - 42°)	Inlet	97	94	92	88	88	87	84	79	101
HMFx 100 T4/T6 (A3:4) F400 (1000 RPM - 20°)	Inlet	56	67	72	79	82	83	84	81	89
HMFx 100 T4/T6 (A3:4) F400 (1000 RPM - 22°)	Inlet	57	67	72	79	82	83	84	80	89
HMFx 100 T4/T6 (A3:4) F400 (1000 RPM - 24°)	Inlet	57	66	72	78	82	83	84	80	89

Sound power Lw dB (A)										
Model		63 Hz	125 Hz	250 Hz	500 Hz	1000 Hz	2000 Hz	4000 Hz	8000 Hz	Total
HMFx 100 T4/T6 (A3:4) F400 (1000 RPM - 26°)	Inlet	57	66	72	77	81	82	84	78	88
HMFx 100 T4/T6 (A3:4) F400 (1000 RPM - 28°)	Inlet	58	65	71	77	81	82	83	78	88
HMFx 100 T4/T6 (A3:4) F400 (1000 RPM - 30°)	Inlet	58	65	71	77	80	81	83	77	88
HMFx 100 T4/T6 (A3:4) F400 (1000 RPM - 32°)	Inlet	59	64	71	76	80	81	83	76	87
HMFx 100 T4/T6 (A3:4) F400 (1000 RPM - 34°)	Inlet	59	64	71	76	79	81	82	76	87
HMFx 100 T4/T6 (A3:4) F400 (1000 RPM - 36°)	Inlet	59	64	72	76	79	81	82	76	87
HMFx 100 T4/T6 (A3:4) F400 (1000 RPM - 38°)	Inlet	59	65	72	77	80	81	82	76	87
HMFx 100 T4/T6 (A3:4) F400 (1000 RPM - 40°)	Inlet	59	66	72	78	81	81	83	77	88
HMFx 100 T4/T6 (A3:4) F400 (1000 RPM - 42°)	Inlet	60	67	73	79	83	82	83	78	89
HMFx 100 T4/T6 (A3:4) F400 (1500 RPM - 20°)	Inlet	66	76	81	88	91	92	93	90	98
HMFx 100 T4/T6 (A3:4) F400 (1500 RPM - 22°)	Inlet	66	76	82	88	91	92	93	90	98
HMFx 100 T4/T6 (A3:4) F400 (1500 RPM - 24°)	Inlet	67	76	81	87	91	92	93	89	98
HMFx 100 T4/T6 (A3:4) F400 (1500 RPM - 26°)	Inlet	67	75	81	87	90	91	93	88	97
HMFx 100 T4/T6 (A3:4) F400 (1500 RPM - 28°)	Inlet	67	75	81	86	90	91	93	87	97
HMFx 100 T4/T6 (A3:4) F400 (1500 RPM - 30°)	Inlet	68	74	81	86	90	91	93	86	97
HMFx 100 T4/T6 (A3:4) F400 (1500 RPM - 32°)	Inlet	68	74	81	86	89	90	92	86	96
HMFx 100 T4/T6 (A3:4) F400 (1500 RPM - 34°)	Inlet	69	73	81	85	88	90	91	85	96
HMFx 100 T4/T6 (A3:4) F400 (1500 RPM - 36°)	Inlet	69	73	81	86	88	90	91	85	96
HMFx 100 T4/T6 (A3:4) F400 (1500 RPM - 38°)	Inlet	68	74	81	86	89	90	92	85	96
HMFx 100 T4/T6 (A3:4) F400 (1500 RPM - 40°)	Inlet	68	75	81	87	90	91	92	86	97
HMFx 100 T4/T6 (A3:4) F400 (1500 RPM - 42°)	Inlet	69	77	83	88	92	92	93	87	98
HMFx 100 T4/T6 (A3:8) F400 (1000 RPM - 20°)	Inlet	63	71	83	92	90	89	90	86	97

Sound power Lw dB (A)										
Model		63 Hz	125 Hz	250 Hz	500 Hz	1000 Hz	2000 Hz	4000 Hz	8000 Hz	Total
HMFx 100 T4/T6 (A3:8) F400 (1000 RPM - 22°)	Inlet	63	71	82	90	90	89	90	85	96
HMFx 100 T4/T6 (A3:8) F400 (1000 RPM - 24°)	Inlet	62	70	80	88	88	87	88	83	94
HMFx 100 T4/T6 (A3:8) F400 (1000 RPM - 26°)	Inlet	62	70	79	86	87	87	87	82	93
HMFx 100 T4/T6 (A3:8) F400 (1000 RPM - 28°)	Inlet	62	70	78	84	86	86	87	81	92
HMFx 100 T4/T6 (A3:8) F400 (1000 RPM - 30°)	Inlet	62	70	77	82	85	86	86	80	91
HMFx 100 T4/T6 (A3:8) F400 (1000 RPM - 32°)	Inlet	62	69	75	80	84	85	85	79	90
HMFx 100 T4/T6 (A3:8) F400 (1000 RPM - 34°)	Inlet	61	68	73	79	83	84	85	78	90
HMFx 100 T4/T6 (A3:8) F400 (1000 RPM - 36°)	Inlet	61	68	73	78	82	84	85	78	89
HMFx 100 T4/T6 (A3:8) F400 (1000 RPM - 38°)	Inlet	62	69	74	79	83	84	85	79	90
HMFx 100 T4/T6 (A3:8) F400 (1000 RPM - 40°)	Inlet	62	69	74	79	83	85	85	79	90
HMFx 100 T4/T6 (A3:8) F400 (1000 RPM - 42°)	Inlet	63	70	75	80	83	85	86	79	90
HMFx 100 T4/T6 (A3:8) F400 (1500 RPM - 20°)	Inlet	72	81	92	102	100	99	100	95	107
HMFx 100 T4/T6 (A3:8) F400 (1500 RPM - 22°)	Inlet	72	80	91	100	99	98	99	94	106
HMFx 100 T4/T6 (A3:8) F400 (1500 RPM - 24°)	Inlet	72	79	89	97	97	97	98	93	104
HMFx 100 T4/T6 (A3:8) F400 (1500 RPM - 26°)	Inlet	72	79	88	95	96	96	97	92	103
HMFx 100 T4/T6 (A3:8) F400 (1500 RPM - 28°)	Inlet	72	79	87	93	96	95	96	91	102
HMFx 100 T4/T6 (A3:8) F400 (1500 RPM - 30°)	Inlet	72	79	86	91	95	95	96	90	101
HMFx 100 T4/T6 (A3:8) F400 (1500 RPM - 32°)	Inlet	71	79	84	90	93	94	95	89	100
HMFx 100 T4/T6 (A3:8) F400 (1500 RPM - 34°)	Inlet	71	78	83	88	92	93	94	88	99
HMFx 100 T4/T6 (A3:8) F400 (1500 RPM - 36°)	Inlet	70	77	82	87	91	93	94	87	99
HMFx 100 T4/T6 (A3:8) F400 (1500 RPM - 38°)	Inlet	71	78	83	88	92	94	94	88	99
HMFx 100 T4/T6 (A3:8) F400 (1500 RPM - 40°)	Inlet	71	79	84	89	92	94	95	89	100

Sound power Lw dB (A)										
Model		63 Hz	125 Hz	250 Hz	500 Hz	1000 Hz	2000 Hz	4000 Hz	8000 Hz	Total
HMFx 100 T4/T6 (A3:8) F400 (1500 RPM - 42°)	Inlet	72	79	84	89	93	94	95	89	100
HMFx 112 T4/T6 (A3:4) F400 (1000 RPM - 20°)	Inlet	56	69	74	81	84	85	87	83	91
HMFx 112 T4/T6 (A3:4) F400 (1000 RPM - 22°)	Inlet	58	69	74	81	85	86	87	83	92
HMFx 112 T4/T6 (A3:4) F400 (1000 RPM - 24°)	Inlet	59	69	74	80	84	85	86	82	91
HMFx 112 T4/T6 (A3:4) F400 (1000 RPM - 26°)	Inlet	60	69	74	80	84	84	86	81	90
HMFx 112 T4/T6 (A3:4) F400 (1000 RPM - 28°)	Inlet	61	69	74	79	83	84	85	80	90
HMFx 112 T4/T6 (A3:4) F400 (1000 RPM - 30°)	Inlet	61	68	73	79	82	83	85	78	89
HMFx 112 T4/T6 (A3:4) F400 (1000 RPM - 32°)	Inlet	61	67	73	78	82	83	84	78	89
HMFx 112 T4/T6 (A3:4) F400 (1000 RPM - 34°)	Inlet	61	67	73	78	81	82	84	77	88
HMFx 112 T4/T6 (A3:4) F400 (1000 RPM - 36°)	Inlet	61	67	73	78	81	82	84	77	88
HMFx 112 T4/T6 (A3:4) F400 (1000 RPM - 38°)	Inlet	62	68	74	79	81	83	84	77	89
HMFx 112 T4/T6 (A3:4) F400 (1000 RPM - 40°)	Inlet	63	69	75	79	82	84	84	78	89
HMFx 112 T4/T6 (A3:4) F400 (1000 RPM - 42°)	Inlet	63	70	75	80	83	84	85	79	90
HMFx 112 T4/T6 (A3:4) F400 (1500 RPM - 20°)	Inlet	66	78	83	90	94	94	96	92	101
HMFx 112 T4/T6 (A3:4) F400 (1500 RPM - 22°)	Inlet	68	79	84	90	94	95	96	92	102
HMFx 112 T4/T6 (A3:4) F400 (1500 RPM - 24°)	Inlet	69	78	83	90	93	94	96	91	101
HMFx 112 T4/T6 (A3:4) F400 (1500 RPM - 26°)	Inlet	70	78	83	89	93	94	95	90	100
HMFx 112 T4/T6 (A3:4) F400 (1500 RPM - 28°)	Inlet	71	78	83	89	92	93	95	89	99
HMFx 112 T4/T6 (A3:4) F400 (1500 RPM - 30°)	Inlet	71	78	83	88	92	93	94	88	99
HMFx 112 T4/T6 (A3:4) F400 (1500 RPM - 32°)	Inlet	70	77	82	88	91	92	94	87	98
HMFx 112 T4/T6 (A3:4) F400 (1500 RPM - 34°)	Inlet	70	76	82	87	90	92	93	86	98
HMFx 112 T4/T6 (A3:4) F400 (1500 RPM - 36°)	Inlet	71	76	83	87	90	92	93	86	98

Sound power Lw dB (A)										
Model		63 Hz	125 Hz	250 Hz	500 Hz	1000 Hz	2000 Hz	4000 Hz	8000 Hz	Total
HMFx 112 T4/T6 (A3:4) F400 (1500 RPM - 38°)	Inlet	71	77	83	88	91	92	93	87	98
HMFx 112 T4/T6 (A3:4) F400 (1500 RPM - 40°)	Inlet	72	79	84	89	91	93	94	87	99
HMFx 112 T4/T6 (A3:4) F400 (1500 RPM - 42°)	Inlet	72	79	84	89	92	94	94	88	99
HMFx 112 T4/T6 (A3:8) F400 (1000 RPM - 20°)	Inlet	64	73	82	91	91	93	93	88	99
HMFx 112 T4/T6 (A3:8) F400 (1000 RPM - 22°)	Inlet	64	72	81	90	90	92	92	87	97
HMFx 112 T4/T6 (A3:8) F400 (1000 RPM - 24°)	Inlet	64	72	80	88	90	91	91	86	96
HMFx 112 T4/T6 (A3:8) F400 (1000 RPM - 26°)	Inlet	64	71	80	86	89	90	90	85	96
HMFx 112 T4/T6 (A3:8) F400 (1000 RPM - 28°)	Inlet	65	71	79	85	89	90	90	84	95
HMFx 112 T4/T6 (A3:8) F400 (1000 RPM - 30°)	Inlet	65	71	78	84	88	89	89	84	94
HMFx 112 T4/T6 (A3:8) F400 (1000 RPM - 32°)	Inlet	64	71	77	82	86	88	88	82	93
HMFx 112 T4/T6 (A3:8) F400 (1000 RPM - 34°)	Inlet	64	71	76	81	84	86	87	80	91
HMFx 112 T4/T6 (A3:8) F400 (1000 RPM - 36°)	Inlet	63	70	75	80	84	86	86	79	91
HMFx 112 T4/T6 (A3:8) F400 (1000 RPM - 38°)	Inlet	64	71	76	81	84	86	86	80	91
HMFx 112 T4/T6 (A3:8) F400 (1000 RPM - 40°)	Inlet	64	71	76	81	85	87	86	80	92
HMFx 112 T4/T6 (A3:8) F400 (1500 RPM - 20°)	Inlet	73	82	92	101	101	103	103	97	109
HMFx 112 T4/T6 (A3:8) F400 (1500 RPM - 22°)	Inlet	73	81	91	99	100	102	102	96	107
HMFx 112 T4/T6 (A3:8) F400 (1500 RPM - 24°)	Inlet	73	81	90	97	99	101	101	95	106
HMFx 112 T4/T6 (A3:8) F400 (1500 RPM - 26°)	Inlet	74	81	89	96	98	100	100	94	106
HMFx 112 T4/T6 (A3:8) F400 (1500 RPM - 28°)	Inlet	74	81	88	94	98	99	99	94	105
HMFx 112 T4/T6 (A3:8) F400 (1500 RPM - 30°)	Inlet	74	80	87	93	97	99	99	93	104
HMFx 112 T4/T6 (A3:8) F400 (1500 RPM - 32°)	Inlet	74	81	86	91	96	97	97	91	103
HMFx 112 T4/T6 (A3:8) F400 (1500 RPM - 34°)	Inlet	73	80	85	90	94	96	96	89	101



Sound power Lw dB (A)										
Model		63 Hz	125 Hz	250 Hz	500 Hz	1000 Hz	2000 Hz	4000 Hz	8000 Hz	Total
HMFx 112 T4/T6 (A3:8) F400 (1500 RPM - 36°)	Inlet	73	80	85	90	93	95	95	89	101
HMFx 112 T4/T6 (A3:8) F400 (1500 RPM - 38°)	Inlet	73	80	85	90	94	96	95	89	101
HMFx 112 T4/T6 (A3:8) F400 (1500 RPM - 40°)	Inlet	74	81	86	90	94	96	95	90	102
HMFx 125 T4/T6 (A3:4) F400 (1000 RPM - 20°)	Inlet	63	76	81	89	92	92	94	91	99
HMFx 125 T4/T6 (A3:4) F400 (1000 RPM - 22°)	Inlet	65	77	82	89	92	93	95	91	99
HMFx 125 T4/T6 (A3:4) F400 (1000 RPM - 24°)	Inlet	66	76	81	87	90	91	93	89	97
HMFx 125 T4/T6 (A3:4) F400 (1000 RPM - 26°)	Inlet	66	74	79	85	89	90	91	86	96
HMFx 125 T4/T6 (A3:4) F400 (1000 RPM - 28°)	Inlet	66	73	78	83	87	88	89	84	94
HMFx 125 T4/T6 (A3:4) F400 (1000 RPM - 30°)	Inlet	65	72	77	82	85	87	88	82	92
HMFx 125 T4/T6 (A3:4) F400 (1000 RPM - 32°)	Inlet	65	72	77	81	85	86	87	80	92
HMFx 125 T4/T6 (A3:4) F400 (1000 RPM - 34°)	Inlet	64	71	76	81	84	85	87	79	91
HMFx 125 T4/T6 (A3:4) F400 (1000 RPM - 36°)	Inlet	64	71	76	81	84	85	86	79	91
HMFx 125 T4/T6 (A3:4) F400 (1000 RPM - 38°)	Inlet	65	72	77	81	84	86	87	79	91
HMFx 125 T4/T6 (A3:4) F400 (1000 RPM - 40°)	Inlet	65	72	77	82	84	87	87	80	92
HMFx 125 T4/T6 (A3:4) F400 (1000 RPM - 42°)	Inlet	66	73	78	83	85	87	87	81	92
HMFx 125 T4/T6 (A3:4) F400 (1500 RPM - 20°)	Inlet	72	85	90	98	102	102	104	101	109
HMFx 125 T4/T6 (A3:4) F400 (1500 RPM - 22°)	Inlet	75	86	91	98	102	103	105	101	109
HMFx 125 T4/T6 (A3:4) F400 (1500 RPM - 24°)	Inlet	75	85	90	96	100	101	103	98	107
HMFx 125 T4/T6 (A3:4) F400 (1500 RPM - 26°)	Inlet	76	84	89	94	98	99	101	96	106
HMFx 125 T4/T6 (A3:4) F400 (1500 RPM - 28°)	Inlet	75	82	87	93	96	98	99	93	104
HMFx 125 T4/T6 (A3:4) F400 (1500 RPM - 30°)	Inlet	74	81	86	91	95	96	97	91	102
HMFx 125 T4/T6 (A3:4) F400 (1500 RPM - 32°)	Inlet	74	81	86	90	94	96	96	90	102

Sound power Lw dB (A)										
Model		63 Hz	125 Hz	250 Hz	500 Hz	1000 Hz	2000 Hz	4000 Hz	8000 Hz	Total
HMFX 125 T4/T6 (A3:4) F400 (1500 RPM - 34°)	Inlet	73	80	85	90	93	95	96	88	101
HMFX 125 T4/T6 (A3:4) F400 (1500 RPM - 36°)	Inlet	74	81	86	90	93	95	96	88	101
HMFX 125 T4/T6 (A3:4) F400 (1500 RPM - 38°)	Inlet	74	81	86	91	93	95	96	89	101
HMFX 125 T4/T6 (A3:4) F400 (1500 RPM - 40°)	Inlet	75	82	87	91	93	96	96	89	102
HMFX 125 T4/T6 (A3:4) F400 (1500 RPM - 42°)	Inlet	75	82	87	92	94	96	96	90	102
HMFX 125 T4/T6 (A3:8) F400 (38°)	Inlet	76	83	88	93	96	98	97	91	104
HMFX 125 T4/T6 (A3:8) F400 (1000 RPM - 20°)	Inlet	69	77	84	93	98	101	100	95	105
HMFX 125 T4/T6 (A3:8) F400 (1000 RPM - 22°)	Inlet	69	77	84	92	97	100	99	94	104
HMFX 125 T4/T6 (A3:8) F400 (1000 RPM - 24°)	Inlet	69	76	83	90	96	98	98	92	103
HMFX 125 T4/T6 (A3:8) F400 (1000 RPM - 26°)	Inlet	69	75	82	89	94	96	96	90	101
HMFX 125 T4/T6 (A3:8) F400 (1000 RPM - 28°)	Inlet	68	75	81	88	92	95	95	89	100
HMFX 125 T4/T6 (A3:8) F400 (1000 RPM - 30°)	Inlet	68	74	80	86	91	93	94	87	98
HMFX 125 T4/T6 (A3:8) F400 (1000 RPM - 32°)	Inlet	68	74	80	85	90	92	92	85	97
HMFX 125 T4/T6 (A3:8) F400 (1000 RPM - 34°)	Inlet	68	74	80	85	88	90	90	83	95
HMFX 125 T4/T6 (A3:8) F400 (1000 RPM - 36°)	Inlet	67	74	79	84	87	89	89	82	94
HMFX 125 T4/T6 (A3:8) F400 (1000 RPM - 38°)	Inlet	67	74	79	84	87	89	88	81	94
HMFX 125 T4/T6 (A3:8) F400 (1000 RPM - 40°)	Inlet	67	74	79	83	87	89	87	81	93
HMFX 125 T4/T6 (A3:8) F400 (1500 RPM - 20°)	Inlet	78	86	93	103	108	111	110	105	115
HMFX 125 T4/T6 (A3:8) F400 (1500 RPM - 22°)	Inlet	79	86	93	102	107	110	109	104	114
HMFX 125 T4/T6 (A3:8) F400 (1500 RPM - 24°)	Inlet	78	85	92	100	106	108	108	102	113
HMFX 125 T4/T6 (A3:8) F400 (1500 RPM - 26°)	Inlet	78	85	91	98	104	106	106	100	111
HMFX 125 T4/T6 (A3:8) F400 (1500 RPM - 28°)	Inlet	78	84	91	97	102	105	105	98	110

Sound power Lw dB (A)										
Model		63 Hz	125 Hz	250 Hz	500 Hz	1000 Hz	2000 Hz	4000 Hz	8000 Hz	Total
HMFX 125 T4/T6 (A3:8) F400 (1500 RPM - 30°)	Inlet	77	83	90	96	101	103	104	97	108
HMFX 125 T4/T6 (A3:8) F400 (1500 RPM - 32°)	Inlet	77	83	89	95	99	102	102	94	107
HMFX 125 T4/T6 (A3:8) F400 (1500 RPM - 34°)	Inlet	77	83	89	94	97	99	100	92	105
HMFX 125 T4/T6 (A3:8) F400 (1500 RPM - 36°)	Inlet	77	83	89	93	96	98	98	91	104
HMFX 125 T4/T6 (A3:8) F400 (1500 RPM - 40°)	Inlet	76	83	88	93	96	98	97	90	103

### Sound / 4/8 poles

Sound power Lw dB (A)										
Model		63 Hz	125 Hz	250 Hz	500 Hz	1000 Hz	2000 Hz	4000 Hz	8000 Hz	Total
HMFX 45 T4/T8 (A5:6) F400 (20°)	Inlet	44	50	56	65	61	63	65	59	70
HMFX 45 T4/T8 (A5:6) F400 (25°)	Inlet	46	51	58	65	64	65	67	59	72
HMFX 45 T4/T8 (A5:6) F400 (27°)	Inlet	47	52	59	65	65	66	67	59	72
HMFX 45 T4/T8 (A5:6) F400 (30°)	Inlet	49	54	61	65	67	68	69	60	74
HMFX 45 T4/T8 (A5:6) F400 (33°)	Inlet	50	54	62	64	67	68	69	60	74
HMFX 45 T4/T8 (A5:6) F400 (35°)	Inlet	50	54	62	63	68	68	70	59	74
HMFX 45 T4/T8 (A5:6) F400 (37°)	Inlet	52	55	64	65	69	69	71	61	76
HMFX 45 T4/T8 (A5:6) F400 (40°)	Inlet	53	57	65	67	70	70	72	63	77
HMFX 45 T4/T8 (A5:6) F400 (43°)	Inlet	53	57	65	67	71	71	73	64	77
HMFX 50 T4/T8 (A5:6) F400 (25°)	Inlet	45	52	57	62	65	67	69	61	73
HMFX 50 T4/T8 (A5:6) F400 (27°)	Inlet	46	53	58	63	66	68	70	62	74
HMFX 50 T4/T8 (A5:6) F400 (30°)	Inlet	48	53	60	64	67	68	71	62	75
HMFX 50 T4/T8 (A5:6) F400 (33°)	Inlet	49	54	61	66	69	70	72	63	76
HMFX 50 T4/T8 (A5:6) F400 (35°)	Inlet	50	55	62	68	70	71	73	64	78
HMFX 50 T4/T8 (A5:6) F400 (37°)	Inlet	50	57	62	68	70	71	73	64	78
HMFX 50 T4/T8 (A5:6) F400 (40°)	Inlet	50	57	62	68	70	71	73	64	78
HMFX 50 T4/T8 (A5:6) F400 (43°)	Inlet	53	60	65	72	73	73	76	67	80
HMFX 50 T4/T8 (A5:6) F400 (45°)	Inlet	53	60	65	73	74	74	76	68	81
HMFX 56 T4/T8 (A5:6) F400 (750 RPM - 20°)	Inlet	50	57	62	63	64	62	60	52	70
HMFX 56 T4/T8 (A5:6) F400 (750 RPM - 25°)	Inlet	37	46	51	57	59	59	60	51	66
HMFX 56 T4/T8 (A5:6) F400 (750 RPM - 30°)	Inlet	46	56	63	65	65	63	61	53	71

Sound power Lw dB (A)										
Model		63 Hz	125 Hz	250 Hz	500 Hz	1000 Hz	2000 Hz	4000 Hz	8000 Hz	Total
HMFx 56 T4/T8 (A5:6) F400 (750 RPM - 35°)	Inlet	34	46	51	57	58	59	60	52	65
HMFx 56 T4/T8 (A5:6) F400 (750 RPM - 40°)	Inlet	40	53	63	69	68	62	60	51	73
HMFx 56 T4/T8 (A5:6) F400 (750 RPM - 45°)	Inlet	45	57	72	78	75	64	60	51	81
HMFx 56 T4/T8 (A5:6) F400 (1500 RPM - 20°)	Inlet	66	73	78	79	80	78	76	68	86
HMFx 56 T4/T8 (A5:6) F400 (1500 RPM - 25°)	Inlet	53	62	67	73	75	75	76	67	82
HMFx 56 T4/T8 (A5:6) F400 (1500 RPM - 30°)	Inlet	62	72	79	81	81	79	77	69	87
HMFx 56 T4/T8 (A5:6) F400 (1500 RPM - 35°)	Inlet	50	62	67	73	74	75	76	68	81
HMFx 56 T4/T8 (A5:6) F400 (1500 RPM - 40°)	Inlet	56	69	79	85	84	78	76	67	89
HMFx 56 T4/T8 (A5:6) F400 (1500 RPM - 45°)	Inlet	60	73	88	94	91	80	76	67	96
HMFx 63 T4/T8 (A5:6) F400 (750 RPM - 20°)	Inlet	53	60	65	66	67	64	63	56	73
HMFx 63 T4/T8 (A5:6) F400 (750 RPM - 25°)	Inlet	39	48	53	58	62	61	61	54	67
HMFx 63 T4/T8 (A5:6) F400 (750 RPM - 30°)	Inlet	41	49	59	66	64	63	63	56	71
HMFx 63 T4/T8 (A5:6) F400 (750 RPM - 35°)	Inlet	37	49	54	58	62	61	63	56	68
HMFx 63 T4/T8 (A5:6) F400 (750 RPM - 40°)	Inlet	38	50	62	73	70	65	63	55	76
HMFx 63 T4/T8 (A5:6) F400 (750 RPM - 45°)	Inlet	39	50	67	84	76	68	63	55	85
HMFx 63 T4/T8 (A5:6) F400 (1500 RPM - 20°)	Inlet	69	76	81	82	83	80	79	72	89
HMFx 63 T4/T8 (A5:6) F400 (1500 RPM - 25°)	Inlet	54	63	68	73	77	76	76	70	83
HMFx 63 T4/T8 (A5:6) F400 (1500 RPM - 30°)	Inlet	57	65	75	82	80	79	79	72	87
HMFx 63 T4/T8 (A5:6) F400 (1500 RPM - 35°)	Inlet	53	65	70	74	78	77	79	72	84
HMFx 63 T4/T8 (A5:6) F400 (1500 RPM - 40°)	Inlet	54	66	77	89	86	81	79	71	92
HMFx 63 T4/T8 (A5:6) F400 (1500 RPM - 45°)	Inlet	55	66	82	100	92	84	79	71	100
HMFx 71 T4/T8 (A5:6) F400 (750 RPM - 20°)	Inlet	56	63	68	70	70	68	67	60	76

Sound power Lw dB (A)										
Model		63 Hz	125 Hz	250 Hz	500 Hz	1000 Hz	2000 Hz	4000 Hz	8000 Hz	Total
HMFx 71 T4/T8 (A5:6) F400 (750 RPM - 25°)	Inlet	43	52	58	62	65	66	66	57	72
HMFx 71 T4/T8 (A5:6) F400 (750 RPM - 30°)	Inlet	44	53	59	65	66	66	65	56	72
HMFx 71 T4/T8 (A5:6) F400 (750 RPM - 35°)	Inlet	37	49	54	59	62	63	64	55	69
HMFx 71 T4/T8 (A5:6) F400 (750 RPM - 40°)	Inlet	41	52	67	76	72	68	66	56	79
HMFx 71 T4/T8 (A5:6) F400 (750 RPM - 45°)	Inlet	45	54	76	89	80	71	67	56	90
HMFx 71 T4/T8 (A5:6) F400 (1500 RPM - 20°)	Inlet	71	78	83	85	85	83	82	75	92
HMFx 71 T4/T8 (A5:6) F400 (1500 RPM - 25°)	Inlet	58	68	74	78	81	82	82	73	88
HMFx 71 T4/T8 (A5:6) F400 (1500 RPM - 30°)	Inlet	60	68	75	81	82	81	81	72	87
HMFx 71 T4/T8 (A5:6) F400 (1500 RPM - 35°)	Inlet	53	65	70	75	78	79	80	71	84
HMFx 71 T4/T8 (A5:6) F400 (1500 RPM - 40°)	Inlet	57	68	83	92	88	83	81	72	95
HMFx 71 T4/T8 (A5:6) F400 (1500 RPM - 45°)	Inlet	61	70	92	105	96	87	83	72	105
HMFx 80 T4/T8 (A5:6) F400 (750 RPM - 20°)	Inlet	58	65	70	72	72	70	69	62	79
HMFx 80 T4/T8 (A5:6) F400 (750 RPM - 25°)	Inlet	45	52	58	63	65	65	66	58	72
HMFx 80 T4/T8 (A5:6) F400 (750 RPM - 30°)	Inlet	45	57	64	73	71	69	69	61	78
HMFx 80 T4/T8 (A5:6) F400 (750 RPM - 35°)	Inlet	42	54	60	68	73	71	71	62	78
HMFx 80 T4/T8 (A5:6) F400 (750 RPM - 40°)	Inlet	43	56	72	77	74	70	68	60	81
HMFx 80 T4/T8 (A5:6) F400 (750 RPM - 45°)	Inlet	44	58	81	84	75	70	66	59	86
HMFx 80 T4/T8 (A5:6) F400 (1500 RPM - 20°)	Inlet	74	81	86	88	88	86	85	78	94
HMFx 80 T4/T8 (A5:6) F400 (1500 RPM - 25°)	Inlet	61	68	74	79	81	81	82	74	88
HMFx 80 T4/T8 (A5:6) F400 (1500 RPM - 30°)	Inlet	61	72	79	89	87	85	85	77	93
HMFx 80 T4/T8 (A5:6) F400 (1500 RPM - 35°)	Inlet	58	70	76	84	89	87	87	78	94
HMFx 80 T4/T8 (A5:6) F400 (1500 RPM - 40°)	Inlet	59	72	88	93	90	86	84	76	97

Sound power Lw dB (A)										
Model		63 Hz	125 Hz	250 Hz	500 Hz	1000 Hz	2000 Hz	4000 Hz	8000 Hz	Total
HMFx 80 T4/T8 (A5:6) F400 (1500 RPM - 45°)	Inlet	60	74	97	100	91	86	82	75	102
HMFx 90 T4/T8 (A3:4) F400 (750 RPM - 20°)	Inlet	67	68	66	71	72	71	69	63	78
HMFx 90 T4/T8 (A3:4) F400 (750 RPM - 22°)	Inlet	71	69	67	70	71	70	69	63	78
HMFx 90 T4/T8 (A3:4) F400 (750 RPM - 24°)	Inlet	73	70	68	70	70	69	68	62	79
HMFx 90 T4/T8 (A3:4) F400 (750 RPM - 26°)	Inlet	74	71	69	70	69	68	67	61	79
HMFx 90 T4/T8 (A3:4) F400 (750 RPM - 28°)	Inlet	75	72	70	70	68	67	67	61	80
HMFx 90 T4/T8 (A3:4) F400 (750 RPM - 30°)	Inlet	77	74	72	70	67	66	66	60	80
HMFx 90 T4/T8 (A3:4) F400 (750 RPM - 32°)	Inlet	76	73	71	69	67	66	66	60	80
HMFx 90 T4/T8 (A3:4) F400 (750 RPM - 34°)	Inlet	76	73	71	69	67	67	65	59	79
HMFx 90 T4/T8 (A3:4) F400 (750 RPM - 36°)	Inlet	76	73	71	69	68	67	66	59	80
HMFx 90 T4/T8 (A3:4) F400 (750 RPM - 38°)	Inlet	77	74	72	69	69	68	66	61	81
HMFx 90 T4/T8 (A3:4) F400 (750 RPM - 40°)	Inlet	78	75	73	70	71	68	67	62	82
HMFx 90 T4/T8 (A3:4) F400 (750 RPM - 42°)	Inlet	79	76	74	71	72	69	68	63	83
HMFx 90 T4/T8 (A3:4) F400 (1500 RPM - 20°)	Inlet	83	84	82	87	88	87	85	79	94
HMFx 90 T4/T8 (A3:4) F400 (1500 RPM - 22°)	Inlet	87	85	83	86	87	86	85	78	94
HMFx 90 T4/T8 (A3:4) F400 (1500 RPM - 24°)	Inlet	89	86	84	86	86	85	84	78	95
HMFx 90 T4/T8 (A3:4) F400 (1500 RPM - 26°)	Inlet	90	87	85	86	85	84	83	77	95
HMFx 90 T4/T8 (A3:4) F400 (1500 RPM - 28°)	Inlet	91	88	86	86	84	83	83	77	95
HMFx 90 T4/T8 (A3:4) F400 (1500 RPM - 30°)	Inlet	92	89	87	86	83	82	82	76	96
HMFx 90 T4/T8 (A3:4) F400 (1500 RPM - 32°)	Inlet	92	89	87	85	83	82	82	76	96
HMFx 90 T4/T8 (A3:4) F400 (1500 RPM - 34°)	Inlet	91	88	86	84	83	83	81	75	95
HMFx 90 T4/T8 (A3:4) F400 (1500 RPM - 36°)	Inlet	92	89	87	84	84	83	81	75	96

Sound power Lw dB (A)										
Model		63 Hz	125 Hz	250 Hz	500 Hz	1000 Hz	2000 Hz	4000 Hz	8000 Hz	Total
HMFx 90 T4/T8 (A3:4) F400 (1500 RPM - 38°)	Inlet	93	90	88	85	85	83	82	77	97
HMFx 90 T4/T8 (A3:4) F400 (1500 RPM - 40°)	Inlet	94	91	89	86	87	84	83	78	98
HMFx 90 T4/T8 (A3:4) F400 (1500 RPM - 42°)	Inlet	95	92	90	87	88	85	84	79	99
HMFx 90 T4/T8 (A3:8) F400 (750 RPM - 20°)	Inlet	79	81	83	78	77	70	71	63	88
HMFx 90 T4/T8 (A3:8) F400 (750 RPM - 22°)	Inlet	79	80	81	77	76	71	71	63	87
HMFx 90 T4/T8 (A3:8) F400 (750 RPM - 24°)	Inlet	80	79	79	76	75	71	71	64	86
HMFx 90 T4/T8 (A3:8) F400 (750 RPM - 26°)	Inlet	80	78	77	75	74	71	71	64	85
HMFx 90 T4/T8 (A3:8) F400 (750 RPM - 28°)	Inlet	80	76	75	74	73	71	70	64	84
HMFx 90 T4/T8 (A3:8) F400 (750 RPM - 30°)	Inlet	78	75	73	73	72	71	70	64	83
HMFx 90 T4/T8 (A3:8) F400 (750 RPM - 32°)	Inlet	78	75	73	72	71	71	69	63	82
HMFx 90 T4/T8 (A3:8) F400 (750 RPM - 34°)	Inlet	77	74	72	71	71	70	68	62	81
HMFx 90 T4/T8 (A3:8) F400 (750 RPM - 36°)	Inlet	77	74	72	70	71	70	68	62	81
HMFx 90 T4/T8 (A3:8) F400 (750 RPM - 38°)	Inlet	79	76	74	71	71	70	68	62	83
HMFx 90 T4/T8 (A3:8) F400 (750 RPM - 40°)	Inlet	81	78	76	71	72	70	67	63	84
HMFx 90 T4/T8 (A3:8) F400 (750 RPM - 42°)	Inlet	81	78	76	72	73	71	68	63	85
HMFx 90 T4/T8 (A3:8) F400 (1500 RPM - 20°)	Inlet	95	97	99	94	93	86	87	79	104
HMFx 90 T4/T8 (A3:8) F400 (1500 RPM - 22°)	Inlet	95	96	97	93	92	86	87	79	103
HMFx 90 T4/T8 (A3:8) F400 (1500 RPM - 24°)	Inlet	95	95	95	92	91	87	87	79	102
HMFx 90 T4/T8 (A3:8) F400 (1500 RPM - 26°)	Inlet	96	94	93	91	90	87	87	80	101
HMFx 90 T4/T8 (A3:8) F400 (1500 RPM - 28°)	Inlet	96	92	91	90	89	87	86	80	100
HMFx 90 T4/T8 (A3:8) F400 (1500 RPM - 30°)	Inlet	94	91	89	89	88	87	86	80	99
HMFx 90 T4/T8 (A3:8) F400 (1500 RPM - 32°)	Inlet	93	90	88	88	87	86	85	79	98

Sound power Lw dB (A)										
Model		63 Hz	125 Hz	250 Hz	500 Hz	1000 Hz	2000 Hz	4000 Hz	8000 Hz	Total
HMFx 90 T4/T8 (A3:8) F400 (1500 RPM - 34°)	Inlet	93	90	88	87	87	86	84	78	97
HMFx 90 T4/T8 (A3:8) F400 (1500 RPM - 36°)	Inlet	93	90	88	86	87	86	84	78	97
HMFx 90 T4/T8 (A3:8) F400 (1500 RPM - 38°)	Inlet	95	92	90	87	87	86	83	78	99
HMFx 90 T4/T8 (A3:8) F400 (1500 RPM - 40°)	Inlet	97	94	92	87	88	86	83	79	100
HMFx 90 T4/T8 (A3:8) F400 (1500 RPM - 42°)	Inlet	97	94	92	88	88	87	84	79	101
HMFx 100 T4/T8 (A3:4) F400 (750 RPM - 20°)	Inlet	50	60	66	72	76	76	77	74	82
HMFx 100 T4/T8 (A3:4) F400 (750 RPM - 22°)	Inlet	50	60	66	72	76	76	77	74	82
HMFx 100 T4/T8 (A3:4) F400 (750 RPM - 24°)	Inlet	51	60	66	72	75	76	77	73	82
HMFx 100 T4/T8 (A3:4) F400 (750 RPM - 26°)	Inlet	51	59	65	71	74	75	77	72	82
HMFx 100 T4/T8 (A3:4) F400 (750 RPM - 28°)	Inlet	51	59	65	71	74	75	77	71	81
HMFx 100 T4/T8 (A3:4) F400 (750 RPM - 30°)	Inlet	52	59	65	70	74	75	77	70	81
HMFx 100 T4/T8 (A3:4) F400 (750 RPM - 32°)	Inlet	52	58	65	70	73	74	76	70	80
HMFx 100 T4/T8 (A3:4) F400 (750 RPM - 34°)	Inlet	53	57	65	69	72	74	76	69	80
HMFx 100 T4/T8 (A3:4) F400 (750 RPM - 36°)	Inlet	53	57	65	70	72	74	75	69	80
HMFx 100 T4/T8 (A3:4) F400 (750 RPM - 38°)	Inlet	52	58	65	70	73	74	76	69	80
HMFx 100 T4/T8 (A3:4) F400 (750 RPM - 40°)	Inlet	52	59	66	71	75	75	76	70	81
HMFx 100 T4/T8 (A3:4) F400 (750 RPM - 42°)	Inlet	53	61	67	72	76	76	77	71	82
HMFx 100 T4/T8 (A3:4) F400 (1500 RPM - 20°)	Inlet	66	76	81	88	91	92	93	90	98
HMFx 100 T4/T8 (A3:4) F400 (1500 RPM - 22°)	Inlet	66	76	82	88	91	92	93	90	98
HMFx 100 T4/T8 (A3:4) F400 (1500 RPM - 24°)	Inlet	67	76	81	87	91	92	93	89	98
HMFx 100 T4/T8 (A3:4) F400 (1500 RPM - 26°)	Inlet	67	75	81	87	90	91	93	88	97
HMFx 100 T4/T8 (A3:4) F400 (1500 RPM - 28°)	Inlet	67	75	81	86	90	91	93	87	97



Sound power Lw dB (A)										
Model		63 Hz	125 Hz	250 Hz	500 Hz	1000 Hz	2000 Hz	4000 Hz	8000 Hz	Total
HMFX 100 T4/T8 (A3:4) F400 (1500 RPM - 30°)	Inlet	68	74	81	86	90	91	93	86	97
HMFX 100 T4/T8 (A3:4) F400 (1500 RPM - 32°)	Inlet	68	74	81	86	89	90	92	86	96
HMFX 100 T4/T8 (A3:4) F400 (1500 RPM - 34°)	Inlet	69	73	81	85	88	90	91	85	96
HMFX 100 T4/T8 (A3:4) F400 (1500 RPM - 36°)	Inlet	69	73	81	86	88	90	91	85	96
HMFX 100 T4/T8 (A3:4) F400 (1500 RPM - 38°)	Inlet	68	74	81	86	89	90	92	85	96
HMFX 100 T4/T8 (A3:4) F400 (1500 RPM - 40°)	Inlet	68	75	81	87	90	91	92	86	97
HMFX 100 T4/T8 (A3:4) F400 (1500 RPM - 42°)	Inlet	69	77	83	88	92	92	93	87	98
HMFX 100 T4/T8 (A3:8) F400 (750 RPM - 20°)	Inlet	56	65	76	86	84	83	84	79	91
HMFX 100 T4/T8 (A3:8) F400 (750 RPM - 22°)	Inlet	56	64	75	84	83	82	83	78	90
HMFX 100 T4/T8 (A3:8) F400 (750 RPM - 24°)	Inlet	56	64	73	81	82	81	82	77	88
HMFX 100 T4/T8 (A3:8) F400 (750 RPM - 26°)	Inlet	56	63	72	79	80	80	81	76	87
HMFX 100 T4/T8 (A3:8) F400 (750 RPM - 28°)	Inlet	56	63	71	77	80	80	80	75	86
HMFX 100 T4/T8 (A3:8) F400 (750 RPM - 30°)	Inlet	56	63	70	75	79	79	80	74	85
HMFX 100 T4/T8 (A3:8) F400 (750 RPM - 32°)	Inlet	55	63	68	74	77	78	79	73	84
HMFX 100 T4/T8 (A3:8) F400 (750 RPM - 34°)	Inlet	55	62	67	72	76	77	78	72	83
HMFX 100 T4/T8 (A3:8) F400 (750 RPM - 36°)	Inlet	54	61	66	71	75	77	78	72	83
HMFX 100 T4/T8 (A3:8) F400 (750 RPM - 38°)	Inlet	55	62	67	72	76	78	78	72	83
HMFX 100 T4/T8 (A3:8) F400 (750 RPM - 40°)	Inlet	56	63	68	73	76	78	79	73	84
HMFX 100 T4/T8 (A3:8) F400 (750 RPM - 42°)	Inlet	56	63	68	73	77	78	79	73	84
HMFX 100 T4/T8 (A3:8) F400 (1500 RPM - 20°)	Inlet	72	81	92	102	100	99	100	95	107
HMFX 100 T4/T8 (A3:8) F400 (1500 RPM - 22°)	Inlet	72	80	91	100	99	98	99	94	106
HMFX 100 T4/T8 (A3:8) F400 (1500 RPM - 24°)	Inlet	72	79	89	97	97	97	98	93	104

Sound power Lw dB (A)										
Model		63 Hz	125 Hz	250 Hz	500 Hz	1000 Hz	2000 Hz	4000 Hz	8000 Hz	Total
HMFx 100 T4/T8 (A3:8) F400 (1500 RPM - 26°)	Inlet	72	79	88	95	96	96	97	92	103
HMFx 100 T4/T8 (A3:8) F400 (1500 RPM - 28°)	Inlet	72	79	87	93	96	95	96	91	102
HMFx 100 T4/T8 (A3:8) F400 (1500 RPM - 30°)	Inlet	72	79	86	91	95	95	96	90	101
HMFx 100 T4/T8 (A3:8) F400 (1500 RPM - 32°)	Inlet	71	79	84	90	93	94	95	89	100
HMFx 100 T4/T8 (A3:8) F400 (1500 RPM - 34°)	Inlet	71	78	83	88	92	93	94	88	99
HMFx 100 T4/T8 (A3:8) F400 (1500 RPM - 36°)	Inlet	70	77	82	87	91	93	94	87	99
HMFx 100 T4/T8 (A3:8) F400 (1500 RPM - 38°)	Inlet	71	78	83	88	92	94	94	88	99
HMFx 100 T4/T8 (A3:8) F400 (1500 RPM - 40°)	Inlet	71	79	84	89	92	94	95	89	100
HMFx 100 T4/T8 (A3:8) F400 (1500 RPM - 42°)	Inlet	72	79	84	89	93	94	95	89	100
HMFx 112 T4/T8 (A3:4) F400 (750 RPM - 20°)	Inlet	50	62	67	74	78	78	80	76	85
HMFx 112 T4/T8 (A3:4) F400 (750 RPM - 22°)	Inlet	52	63	68	74	78	79	81	76	86
HMFx 112 T4/T8 (A3:4) F400 (750 RPM - 24°)	Inlet	53	62	67	74	77	78	80	75	85
HMFx 112 T4/T8 (A3:4) F400 (750 RPM - 26°)	Inlet	54	62	67	73	77	78	79	74	84
HMFx 112 T4/T8 (A3:4) F400 (750 RPM - 28°)	Inlet	55	62	67	73	76	77	79	73	83
HMFx 112 T4/T8 (A3:4) F400 (750 RPM - 30°)	Inlet	55	62	67	72	76	77	78	72	83
HMFx 112 T4/T8 (A3:4) F400 (750 RPM - 32°)	Inlet	55	61	67	72	75	76	78	71	82
HMFx 112 T4/T8 (A3:4) F400 (750 RPM - 34°)	Inlet	54	60	66	71	74	76	77	70	82
HMFx 112 T4/T8 (A3:4) F400 (750 RPM - 36°)	Inlet	55	60	67	71	74	76	77	70	82
HMFx 112 T4/T8 (A3:4) F400 (750 RPM - 38°)	Inlet	55	61	67	72	75	76	78	71	82
HMFx 112 T4/T8 (A3:4) F400 (750 RPM - 40°)	Inlet	56	63	68	73	76	77	78	71	83
HMFx 112 T4/T8 (A3:4) F400 (750 RPM - 42°)	Inlet	57	63	69	73	76	78	78	72	83
HMFx 112 T4/T8 (A3:4) F400 (1500 RPM - 20°)	Inlet	66	78	83	90	94	94	96	92	101

Sound power Lw dB (A)										
Model		63 Hz	125 Hz	250 Hz	500 Hz	1000 Hz	2000 Hz	4000 Hz	8000 Hz	Total
HMFX 112 T4/T8 (A3:4) F400 (1500 RPM - 22°)	Inlet	68	79	84	90	94	95	96	92	102
HMFX 112 T4/T8 (A3:4) F400 (1500 RPM - 24°)	Inlet	69	78	83	90	93	94	96	91	101
HMFX 112 T4/T8 (A3:4) F400 (1500 RPM - 26°)	Inlet	70	78	83	89	93	94	95	90	100
HMFX 112 T4/T8 (A3:4) F400 (1500 RPM - 28°)	Inlet	71	78	83	89	92	93	95	89	99
HMFX 112 T4/T8 (A3:4) F400 (1500 RPM - 30°)	Inlet	71	78	83	88	92	93	94	88	99
HMFX 112 T4/T8 (A3:4) F400 (1500 RPM - 32°)	Inlet	70	77	82	88	91	92	94	87	98
HMFX 112 T4/T8 (A3:4) F400 (1500 RPM - 34°)	Inlet	70	76	82	87	90	92	93	86	98
HMFX 112 T4/T8 (A3:4) F400 (1500 RPM - 36°)	Inlet	71	76	83	87	90	92	93	86	98
HMFX 112 T4/T8 (A3:4) F400 (1500 RPM - 38°)	Inlet	71	77	83	88	91	92	93	87	98
HMFX 112 T4/T8 (A3:4) F400 (1500 RPM - 40°)	Inlet	72	79	84	89	91	93	94	87	99
HMFX 112 T4/T8 (A3:4) F400 (1500 RPM - 42°)	Inlet	72	79	84	89	92	94	94	88	99
HMFX 112 T4/T8 (A3:8) F400 (750 RPM - 20°)	Inlet	57	66	76	85	85	87	87	81	93
HMFX 112 T4/T8 (A3:8) F400 (750 RPM - 22°)	Inlet	57	65	75	83	84	86	86	80	91
HMFX 112 T4/T8 (A3:8) F400 (750 RPM - 24°)	Inlet	57	65	74	81	83	85	85	79	90
HMFX 112 T4/T8 (A3:8) F400 (750 RPM - 26°)	Inlet	58	65	73	80	83	84	84	78	90
HMFX 112 T4/T8 (A3:8) F400 (750 RPM - 28°)	Inlet	58	65	72	78	82	83	83	78	89
HMFX 112 T4/T8 (A3:8) F400 (750 RPM - 30°)	Inlet	58	65	72	77	81	83	83	77	88
HMFX 112 T4/T8 (A3:8) F400 (750 RPM - 32°)	Inlet	58	65	70	76	80	81	81	75	87
HMFX 112 T4/T8 (A3:8) F400 (750 RPM - 34°)	Inlet	57	64	69	74	78	80	80	73	85
HMFX 112 T4/T8 (A3:8) F400 (750 RPM - 36°)	Inlet	57	64	69	74	77	79	80	73	85
HMFX 112 T4/T8 (A3:8) F400 (750 RPM - 38°)	Inlet	57	64	69	74	78	80	80	73	85
HMFX 112 T4/T8 (A3:8) F400 (750 RPM - 40°)	Inlet	58	65	70	74	78	80	80	74	86

Sound power Lw dB (A)										
Model		63 Hz	125 Hz	250 Hz	500 Hz	1000 Hz	2000 Hz	4000 Hz	8000 Hz	Total
HMFx 112 T4/T8 (A3:8) F400 (750 RPM - 42°)	Inlet	58	65	70	75	78	80	79	73	85
HMFx 112 T4/T8 (A3:8) F400 (1500 RPM - 20°)	Inlet	73	82	92	101	101	103	103	97	109
HMFx 112 T4/T8 (A3:8) F400 (1500 RPM - 22°)	Inlet	73	81	91	99	100	102	102	96	107
HMFx 112 T4/T8 (A3:8) F400 (1500 RPM - 24°)	Inlet	73	81	90	97	99	101	101	95	106
HMFx 112 T4/T8 (A3:8) F400 (1500 RPM - 26°)	Inlet	74	81	89	96	98	100	100	94	106
HMFx 112 T4/T8 (A3:8) F400 (1500 RPM - 28°)	Inlet	74	81	88	94	98	99	99	94	105
HMFx 112 T4/T8 (A3:8) F400 (1500 RPM - 30°)	Inlet	74	80	87	93	97	99	99	93	104
HMFx 112 T4/T8 (A3:8) F400 (1500 RPM - 32°)	Inlet	74	81	86	91	96	97	97	91	103
HMFx 112 T4/T8 (A3:8) F400 (1500 RPM - 34°)	Inlet	73	80	85	90	94	96	96	89	101
HMFx 112 T4/T8 (A3:8) F400 (1500 RPM - 36°)	Inlet	73	80	85	90	93	95	95	89	101
HMFx 112 T4/T8 (A3:8) F400 (1500 RPM - 38°)	Inlet	73	80	85	90	94	96	95	89	101
HMFx 112 T4/T8 (A3:8) F400 (1500 RPM - 40°)	Inlet	74	81	86	90	94	96	95	90	102
HMFx 112 T4/T8 (A3:8) F400 (1500 RPM - 42°)	Inlet	73	80	85	91	94	96	95	89	101
HMFx 125 T4/T8 (A3:4) F400 (750 RPM - 20°)	Inlet	56	69	74	82	86	86	88	85	93
HMFx 125 T4/T8 (A3:4) F400 (750 RPM - 22°)	Inlet	59	70	75	82	86	87	89	85	93
HMFx 125 T4/T8 (A3:4) F400 (750 RPM - 24°)	Inlet	59	69	74	80	84	85	87	82	91
HMFx 125 T4/T8 (A3:4) F400 (750 RPM - 26°)	Inlet	60	68	73	78	82	83	85	80	90
HMFx 125 T4/T8 (A3:4) F400 (750 RPM - 28°)	Inlet	60	67	72	77	80	82	83	77	88
HMFx 125 T4/T8 (A3:4) F400 (750 RPM - 30°)	Inlet	58	65	70	75	79	80	81	75	86
HMFx 125 T4/T8 (A3:4) F400 (750 RPM - 32°)	Inlet	58	65	70	75	78	80	81	74	86
HMFx 125 T4/T8 (A3:4) F400 (750 RPM - 34°)	Inlet	58	65	70	74	77	79	80	72	85
HMFx 125 T4/T8 (A3:4) F400 (750 RPM - 36°)	Inlet	58	65	70	74	77	79	80	72	85

Sound power Lw dB (A)										
Model		63 Hz	125 Hz	250 Hz	500 Hz	1000 Hz	2000 Hz	4000 Hz	8000 Hz	Total
HMFx 125 T4/T8 (A3:4) F400 (750 RPM - 38°)	Inlet	58	65	70	75	77	79	80	73	85
HMFx 125 T4/T8 (A3:4) F400 (750 RPM - 40°)	Inlet	59	66	71	75	78	80	80	73	86
HMFx 125 T4/T8 (A3:4) F400 (750 RPM - 42°)	Inlet	59	66	71	76	79	81	80	74	86
HMFx 125 T4/T8 (A3:4) F400 (1500 RPM - 20°)	Inlet	72	85	90	98	102	102	104	101	109
HMFx 125 T4/T8 (A3:4) F400 (1500 RPM - 22°)	Inlet	75	86	91	98	102	103	105	101	109
HMFx 125 T4/T8 (A3:4) F400 (1500 RPM - 24°)	Inlet	75	85	90	96	100	101	103	98	107
HMFx 125 T4/T8 (A3:4) F400 (1500 RPM - 26°)	Inlet	76	84	89	94	98	99	101	96	106
HMFx 125 T4/T8 (A3:4) F400 (1500 RPM - 28°)	Inlet	75	82	87	93	96	98	99	93	104
HMFx 125 T4/T8 (A3:4) F400 (1500 RPM - 30°)	Inlet	74	81	86	91	95	96	97	91	102
HMFx 125 T4/T8 (A3:4) F400 (1500 RPM - 32°)	Inlet	74	81	86	90	94	96	96	90	102
HMFx 125 T4/T8 (A3:4) F400 (1500 RPM - 34°)	Inlet	73	80	85	90	93	95	96	88	101
HMFx 125 T4/T8 (A3:4) F400 (1500 RPM - 36°)	Inlet	74	81	86	90	93	95	96	88	101
HMFx 125 T4/T8 (A3:4) F400 (1500 RPM - 38°)	Inlet	74	81	86	91	93	95	96	89	101
HMFx 125 T4/T8 (A3:4) F400 (1500 RPM - 40°)	Inlet	75	82	87	91	93	96	96	89	102
HMFx 125 T4/T8 (A3:4) F400 (1500 RPM - 42°)	Inlet	75	82	87	92	94	96	96	90	102
HMFx 125 T4/T8 (A3:8) F400 (750 RPM - 20°)	Inlet	62	71	78	87	92	95	94	89	99
HMFx 125 T4/T8 (A3:8) F400 (750 RPM - 22°)	Inlet	63	70	77	86	91	94	93	88	98
HMFx 125 T4/T8 (A3:8) F400 (750 RPM - 24°)	Inlet	62	70	76	84	90	92	92	86	97
HMFx 125 T4/T8 (A3:8) F400 (750 RPM - 26°)	Inlet	62	69	75	82	88	90	90	84	95
HMFx 125 T4/T8 (A3:8) F400 (750 RPM - 28°)	Inlet	62	68	75	81	86	89	89	82	94
HMFx 125 T4/T8 (A3:8) F400 (750 RPM - 30°)	Inlet	62	67	74	80	85	87	88	81	92
HMFx 125 T4/T8 (A3:8) F400 (750 RPM - 32°)	Inlet	61	67	73	79	83	86	86	79	91

Sound power Lw dB (A)										
Model		63 Hz	125 Hz	250 Hz	500 Hz	1000 Hz	2000 Hz	4000 Hz	8000 Hz	Total
HMFx 125 T4/T8 (A3:8) F400 (750 RPM - 34°)	Inlet	61	68	73	78	81	84	84	76	89
HMFx 125 T4/T8 (A3:8) F400 (750 RPM - 36°)	Inlet	61	68	73	77	81	83	82	75	88
HMFx 125 T4/T8 (A3:8) F400 (750 RPM - 38°)	Inlet	60	67	72	77	80	82	82	75	88
HMFx 125 T4/T8 (A3:8) F400 (750 RPM - 40°)	Inlet	60	67	72	77	80	82	81	74	87
HMFx 125 T4/T8 (A3:8) F400 (750 RPM - 42°)	Inlet	60	67	72	77	80	82	80	74	87
HMFx 125 T4/T8 (A3:8) F400 (1500 RPM - 20°)	Inlet	78	86	93	103	108	111	110	105	115
HMFx 125 T4/T8 (A3:8) F400 (1500 RPM - 22°)	Inlet	79	86	93	102	107	110	109	104	114
HMFx 125 T4/T8 (A3:8) F400 (1500 RPM - 24°)	Inlet	78	85	92	100	106	108	108	102	113
HMFx 125 T4/T8 (A3:8) F400 (1500 RPM - 26°)	Inlet	78	85	91	98	104	106	106	100	111
HMFx 125 T4/T8 (A3:8) F400 (1500 RPM - 28°)	Inlet	78	84	91	97	102	105	105	98	110
HMFx 125 T4/T8 (A3:8) F400 (1500 RPM - 30°)	Inlet	77	83	90	96	101	103	104	97	108
HMFx 125 T4/T8 (A3:8) F400 (1500 RPM - 32°)	Inlet	77	83	89	95	99	102	102	94	107
HMFx 125 T4/T8 (A3:8) F400 (1500 RPM - 34°)	Inlet	77	83	89	94	97	99	100	92	105
HMFx 125 T4/T8 (A3:8) F400 (1500 RPM - 36°)	Inlet	77	83	89	93	96	98	98	91	104
HMFx 125 T4/T8 (A3:8) F400 (1500 RPM - 38°)	Inlet	76	83	88	93	96	98	97	91	104
HMFx 125 T4/T8 (A3:8) F400 (1500 RPM - 40°)	Inlet	76	83	88	93	96	98	97	90	103
HMFx 125 T4/T8 (A3:8) F400 (1500 RPM - 42°)	Inlet	76	83	88	93	96	98	96	90	103